



BEARING CATALOGUE



FOREWORD

Publication Bearing Catalogue ZVL shows a survey of standardized rolling bearings and accessories being produced and delivered under designation ZVL.

In the design, production, the storage and sales of the rolling bearings international standards ISO and national standards are used.

Technical section of the publication contains the most important facts concerning calculations, the design data about the arrangement design, lubrication, as well as mounting and dismounting of rolling bearings. The produced standardized rolling bearings and accessories in the basic design and in the main applications from the basic design, as e.g. bearings with tapered bore, shielded bearings or bearings with snap ring groove on outer ring, etc., are shown in the part Rolling Bearings Dimension Tables.

Foreword		003
1	BASIC CALCULATIONS	006
1.1	Dynamic Load	006
1.1.1	Basic Dynamic Load Rating	006
1.1.2	Life	006
1.1.3	Equivalent Dynamic Load	014
1.1.4	Temperature Influence	016
1.2	Static Load	017
1.2.1	Basic Static Load Rating	017
1.2.2	Equivalent Static Load	017
1.2.3	Bearing Safety under Static Load	018
1.3	Limiting Speed	018
2	ROLLING BEARING DESIGN DATA	019
2.1	BOUNDARY DIMENSIONS	019
2.2	Designation	021
2.3	Tolerance	028
2.4	Internal Clearance	038
2.5	Cages	042
2.6	Shields and Seals	043
3	BEARING ARRANGEMENT DESIGN	044
3.1	General Principles of Rolling Bearing Arrangement Design	044
3.2	Bearing Location	045
3.2.1	Radial Location of Bearing	045
3.2.2	Axial Securing of Bearing	047
3.3	Sealing	052
3.3.1	Non-Contact Sealing	052
3.3.2	Rubbing Sealing	053
3.3.3	Combined Sealing	054
4	BEARING LUBRICATION	054
4.1	Grease Lubrication	054
4.1.1	Relubrication Interval	054
4.1.2	Bearing Greases	055
4.2	Oil Lubrication	058
4.2.1	Bearing Oils	058
4.3	Lubrication with Solid Lubricants	060
5	MOUNTING AND DISMOUNTING OF ROLLING BEARINGS	061
5.1	Storage of Rolling Bearings	061
5.1.2	Influence of Clearance Size in Bearings on its Service Life and Accuracy of Running	061
5.1.3	Relation of Accuracy Grade of Rolling Bearings to Operational Housing	062
5.1.4	Construction of Rolling Bearings Housing	062
5.2	Rolling Bearings Mounting	063
5.2.1	Rolling Bearings Mounting	063
5.2.2	Mounting Workplace	063
5.2.3	Bearing Preparation for Mounting	063
5.2.4	Preparation of Housing Components for Mounting	063
5.2.5	Control of Housing Areas	064
5.2.6.	Cold Mounting	065
5.2.6.1	<i>Cylindrical Housing Areas</i>	065

CONTENTS

5.2.6.2	<i>Tapered Housing Areas</i>	067
5.2.7	Heat Mounting	069
5.2.7.1	<i>Oil Bath Heating up</i>	069
5.2.7.2	<i>Heating up on Heating Plate and in Heating Box</i>	069
5.2.7.3	<i>Hot-air Heater Heating up</i>	069
5.2.7.4	<i>Inductive Heating up</i>	069
5.2.8	Pressure Oil Mounting of Bearings	070
5.2.8.1	<i>Mounting of Bearings with Tapered Bore</i>	070
5.2.9	Mounting of Double Row Cylindrical Roller Bearings with Tapered Bore	071
5.2.10	Axial Bearings Mounting	075
5.2.11	Mounting of Single Row Ball Bearings with Ball Surface and Wider Inner Ring (Insert Ball Bearings)	075
5.3	Rolling Bearings Dismounting	076
5.3.1	Method Selection of Dismounting	076
5.3.2	Mechanical Methods	077
5.3.2.1	<i>Dismounting of Bearings with Cylindrical Bore</i>	077
5.3.2.2	<i>Dismounting of Bearings with Tapered Bore</i>	078
5.3.3	Thermal Methods of Bearings Dismounting	079
5.3.3.1	<i>Heating up Ring</i>	079
5.3.3.2	<i>Inductive Dismounting Equipment</i>	079
5.3.3.3	<i>Circular Burner</i>	079
5.3.4	Hydraulic Method at Bearing Mounitng	079
5.3.4.1	<i>Dismounting of Bearings with Cylindrical Bore</i>	080
5.3.4.2	<i>Dismounting of Bearings with Tapered Bore</i>	080
	Single Row Deep Groove Ball Bearings	083
	Single Row Angular Contact Ball Bearings	093
	Single Row Four-Point Angular Contact Ball Bearings	099
	Double Row Angular Contact Ball Bearings	103
	Double Row Self-Aligning Ball Bearings	109
	Single Row Cylindrical Roller Bearings	115
	Full Complement Cylindrical Roller Bearings	141
	Double Row Spherical Roller Bearings with Cylindrical and Tapered Bore	157
	Single Direction and Double Direction Thrust Ball Bearings	171
	Cylindrical Roller Thrust Bearings	179
	Spherical Roller Thrust Bearings	185
	Insert Ball Bearings and Insert Ball Bearing Housing Units	191
	Spherical Bearings	197
	Special Bearings and Special Angular Contact Bearings	201
	Accessories	207

Required bearing size is determined by the action of the external forces and according to the bearing required life and its reliability in the arrangement. Magnitude, direction and kind of load acting on the bearing, as well as the operating speed, are decisive for the type and bearing size selection. Other special or important conditions of each individual arrangement must be taken into account, e.g. operating temperature, limited space availability, simplicity of mounting, lubrication requirements, sealing, etc., and all of these can influence selection of the most suitable bearing. For given concrete conditions various bearing types can meet those requirements.

From the point of view of outer load acting and the bearing function in respective arrangement or unit we distinguish two types of the rolling bearing load in the bearing technique :

- when rolling bearing rings are relatively rotating against each other and bearing is under outer load (which is valid for most bearings), this is called **dynamic bearing load**,
- when rolling bearing rings either do not move against each other or they move only very slowly, the bearing carries an oscillating motion or the outer load acts for a shorter time than one bearing revolution, this is called **static bearing load**.

For bearing safety calculation, the life limited by bearing breakdown due to material fatigue of a bearing component is decisive in the first case. In the second case there are durable deformations of functional surfaces on the contact surfaces of rolling elements and raceways.

1.1 DYNAMIC LOAD

1.1.1 Basic Dynamic Load Rating

Basic dynamic load rating is a constant invariable load which the bearing can theoretically carry at the nominal life of one million revolutions. For radial bearings, the radial dynamic load rating C_r refers to constant load. For thrust bearings, the axial dynamic load rating C_a refers to unvariable, purely axial load, acting centrally. Basic dynamic load ratings C_r and C_a , whose size depends on bearing dimensions, rolling element number, material and bearing design, are shown for each bearing in the dimension tables. Values of the basic dynamic load ratings were stated according to the standard STN ISO 281. These values are verified in testing equipments and by operation results.

1.1.2 Life

Rolling bearing life is defined as the number of revolution carried out by one bearing ring against the other ring, until the first signs of material fatigue occur on one ring or the rolling element. Great differences in life can occur among bearings of the same type, that is why according to the standard STN ISO 281 the basic life is used as the basis for life calculation, i.e. life shown by the operation time attained or exceeded by a bearing group at 90% reliability.

Life Equation

Nominal bearing life is mathematically defined by the life equation valid for all bearing types.

$$L_{10} = \left(\frac{C}{P} \right)^p \quad \text{or} \quad \frac{C}{P} = \left(L_{10} \right)^{\frac{1}{p}}$$

L_{10}	- nominal life	[10 ⁶ rev]
C	- basic dynamic load rating (values C_r, C_a are given in the dimension tables)	[kN]
P	- equivalent dynamic bearing load	

(equations for P_r , P_a calculations are in section 1.1.3 and at each design group of bearings) [kN]
 p - exponent for ball bearings $p = 3$
for cylindrical, needle-, spherical- and tapered roller bearings $p = 10 / 3$

Table 1 shows dependence of the life L_{10} in million revolutions and respective ratio C/P .
If the rotational speed does not change, the revised life calculation expressing the nominal life in operation hours can be used:

$$L_{10h} = \left(\frac{C}{P} \right)^p \cdot \frac{10^6}{60 \cdot n}$$

L_{10h} - nominal life [h]
 n - rotational speed [min^{-1}]

C/P dependence from the nominal life L_{10} and the rotational speed n is shown for ball bearings in Table 2, for cylindrical roller, needle roller, spherical roller and tapered roller bearings in Table 3.

C/P ratio in dependence on life L_{10}							Table 1
For ball bearings				For cylindrical roller, needle roller, spherical roller and tapered roller bearings			
Life	C/P	Life	C/P	Life	C/P	Life	C/P
L_{10}		L_{10}		L_{10}		L_{10}	
10^6 rew		10^6 rew		10^6 rew		10^6 rew	
0,5	0,793	600	8,43	0,5	0,812	600	6,81
0,75	0,909	650	8,66	0,75	0,917	650	6,98
1	1	700	8,88	1	1	700	7,14
1,5	1,14	750	9,09	1,5	1,13	750	7,29
2	1,26	800	9,28	2	1,24	800	7,43
3	1,44	850	9,47	3	1,39	850	7,56
4	1,59	900	9,65	4	1,52	900	7,70
5	1,71	950	9,83	5	1,62	950	7,82
6	1,82	1000	10	6	1,71	1000	7,94
8	2	1100	10,3	8	1,87	1100	8,17
10	2,15	1200	10,6	10	2	1200	8,39
12	2,29	1300	10,9	12	2,11	1300	8,59
14	2,41	1400	11,2	14	2,21	1400	8,79
16	2,52	1500	11,4	16	2,30	1500	8,97
18	2,62	1600	11,7	18	2,38	1600	9,15
20	2,71	1700	11,9	20	2,46	1700	9,31
25	2,92	1800	12,2	25	2,63	1800	9,48
30	3,11	1900	12,4	30	2,77	1900	9,63
35	3,27	2000	12,6	35	2,91	2000	9,78
40	3,42	2200	13	40	3,02	2200	10,1
45	3,56	2400	13,4	45	3,13	2400	10,3
50	3,68	2600	13,8	50	3,23	2600	10,6
60	3,91	2800	14,1	60	3,42	2800	10,8
70	4,12	3000	14,4	70	3,58	3000	11
80	4,31	3500	15,2	80	3,72	3500	11,5
90	4,48	4000	15,9	90	3,86	4000	12
100	4,64	4500	16,5	100	3,98	4500	12,5
120	4,93	5000	17,1	120	4,20	5000	12,9
140	5,19	5500	17,7	140	4,40	5500	13,2

C/P ratio in dependence on life L_{10}							Table 1
For ball bearings				For cylindrical roller, needle roller, spherical roller and tapered roller bearings			
Life	C/P	Life	C/P	Life	C/P	Life	C/P
L_{10}		L_{10}		L_{10}		L_{10}	
10^6	rew	10^6	rew	10^6	rew	10^6	rew
160	5,43	6000	18,2	160	4,58	6000	13,6
180	5,65	7000	19,1	180	4,75	7000	14,2
200	5,85	8000	20	200	4,90	8000	14,8
250	6,30	9000	20,8	250	5,24	9000	15,4
300	6,69	10000	21,5	300	5,54	10000	15,8
350	7,05	12500	23,2	350	5,80	12500	16,9
400	7,37	15000	24,7	400	6,03	15000	17,9
450	7,66	17500	26	450	6,25	17500	18,7
500	7,94	20000	27,1	500	6,45	20000	19,5
550	8,19	25000	29,2	550	6,64	25000	20,9

C/P ratio in dependence on life L_{10} and rotational speed n for ball bearings														Table 2
Life	Rotational speed n [min^{-1}]													
L_{10h}	10	16	25	40	63	100	125	160	200	250	320	400	500	630
h														
100	-	-	-	-	-	-	-	-	1,06	1,15	1,24	1,34	1,45	1,56
500	-	-	-	1,06	1,24	1,45	1,56	1,68	1,82	1,96	2,12	2,29	2,47	2,67
1 000	-	-	1,15	1,34	1,56	1,82	1,96	2,12	2,29	2,47	2,67	2,88	3,11	3,36
1 250	-	1,06	1,24	1,45	1,68	1,96	2,12	2,29	2,47	2,67	2,88	3,11	3,36	3,63
1 600	-	1,15	1,34	1,56	1,82	2,12	2,29	2,47	2,67	2,88	3,11	3,36	3,63	3,91
2 000	1,06	1,24	1,45	1,68	1,96	2,29	2,47	2,67	2,88	3,11	3,36	3,63	3,91	4,23
2 500	1,15	1,34	1,56	1,82	2,12	2,47	2,67	2,88	3,11	3,36	3,63	3,91	4,23	4,56
3 200	1,24	1,45	1,68	1,96	2,29	2,67	2,88	3,11	3,36	3,63	3,91	4,23	4,56	4,93
4 000	1,34	1,56	1,82	2,12	2,47	2,88	3,11	3,36	3,63	3,91	4,23	4,56	4,93	5,32
5 000	1,45	1,68	1,96	2,29	2,67	3,11	3,36	3,63	3,91	4,23	4,56	4,93	5,32	5,75
6 300	1,56	1,82	2,12	2,47	2,88	3,36	3,63	3,91	4,23	4,56	4,93	5,32	5,75	6,20
8 000	1,68	1,96	2,29	2,67	3,11	3,63	3,91	4,23	4,56	4,93	5,32	5,75	6,20	6,70
10 000	1,82	2,12	2,47	2,88	3,36	3,91	4,23	4,56	4,93	5,32	5,75	6,20	6,70	7,23
12 500	1,96	2,29	2,67	3,11	3,63	4,23	4,56	4,93	5,32	5,75	6,20	6,70	7,23	7,81
16 000	2,12	2,47	2,88	3,36	3,91	4,56	4,93	5,23	5,75	6,20	6,70	7,23	7,81	8,43
20 000	2,29	2,67	3,11	3,63	4,23	4,93	5,32	5,75	6,20	6,70	7,23	7,81	8,43	9,11
25 000	2,47	2,88	3,36	3,91	4,56	5,32	5,75	6,20	6,70	7,23	7,81	8,43	9,11	9,83
32 000	2,67	3,11	3,63	4,23	4,93	5,75	6,20	6,70	7,23	7,81	8,43	9,11	9,83	10,6
40 000	2,88	3,36	3,91	4,56	5,32	6,20	6,70	7,23	7,81	8,43	9,11	9,83	10,6	11,5
50 000	3,11	3,63	4,23	4,93	5,75	6,70	7,23	7,81	8,43	9,11	9,83	10,6	11,5	12,4
63 000	3,36	3,91	4,56	5,32	6,20	7,23	7,81	8,43	9,11	9,83	10,6	11,5	12,4	13,4
80 000	3,63	4,23	4,93	5,75	6,70	7,81	8,43	9,11	9,83	10,6	11,5	12,4	13,4	14,5
100 000	3,91	4,56	5,32	6,20	7,23	8,43	9,11	9,83	10,6	11,5	12,4	13,4	14,5	15,6
200 000	4,93	5,75	6,70	7,81	9,11	10,6	11,5	12,4	13,4	14,5	15,6	16,8	18,2	19,6



C/P ratio in dependence on life L_{10} and rotational speed n for ball bearings

Table 2

Life	Rotational speed n [min ⁻¹]													
	L10h	800	1000	1250	1600	2000	2500	3200	4000	5000	6300	8000	10000	12500
h														
100	1,68	1,82	1,96	2,12	2,29	2,47	2,67	2,88	3,11	3,36	3,63	3,91	4,23	4,56
500	2,88	3,11	3,36	3,63	3,91	4,23	4,56	4,93	5,32	5,75	6,2	6,7	7,23	7,81
1 000	3,63	3,91	4,23	4,56	4,93	5,32	5,75	6,20	6,70	7,23	7,81	8,43	9,11	9,83
1 250	3,91	4,23	4,56	4,93	5,32	5,75	6,20	6,70	7,23	7,81	8,43	9,11	9,83	10,6
1 600	4,23	4,56	4,93	5,32	5,75	6,20	6,70	7,23	7,81	8,43	9,11	9,83	10,6	11,5
2 000	4,56	4,93	5,32	5,75	6,20	6,70	7,23	7,81	8,43	9,11	9,83	10,6	11,5	12,4
2 500	4,93	5,32	5,75	6,20	6,70	7,23	7,81	8,43	9,11	9,83	10,6	11,5	12,4	13,4
3 200	5,32	5,75	6,20	6,70	7,23	7,81	8,43	9,11	9,83	10,6	11,5	12,4	13,4	14,5
4 000	5,75	6,20	6,70	7,23	7,81	8,43	9,11	9,83	10,6	11,5	12,4	13,4	14,5	15,6
5 000	6,20	6,70	7,23	7,81	8,43	9,11	9,83	10,6	11,5	12,4	13,4	14,5	15,6	16,8
6 300	6,70	7,23	7,81	8,43	9,11	9,83	10,6	11,5	12,4	13,4	14,5	15,6	16,8	18,2
8 000	7,23	7,81	8,43	9,11	9,83	10,6	11,5	12,4	13,4	14,5	15,6	16,8	18,2	19,6
10 000	7,81	8,43	9,11	9,83	10,6	11,5	12,4	13,4	14,5	15,6	16,8	18,2	19,6	21,2
12 500	8,43	9,11	9,83	10,6	11,5	12,4	13,4	14,5	15,6	16,8	18,2	19,6	21,2	22,9
16 000	9,11	9,83	10,6	11,5	12,4	13,4	14,5	15,6	16,8	18,2	19,6	21,2	22,9	24,7
20 000	9,83	10,6	11,5	12,4	13,4	14,5	15,6	16,8	18,2	19,6	21,2	22,9	24,7	26,7
25 000	10,6	11,5	12,4	13,4	14,5	15,6	16,8	18,2	19,6	21,2	22,9	24,7	26,7	28,8
32 000	11,5	12,4	13,4	14,5	15,6	16,8	18,2	19,6	21,2	22,9	24,7	26,7	28,8	31,1
40 000	12,4	13,4	14,5	15,6	16,8	18,2	19,6	21,2	22,9	24,7	26,7	28,8	31,1	-
50 000	13,4	14,5	15,6	16,8	18,2	19,6	21,2	22,9	24,7	26,7	28,8	31,1	-	-
63 000	14,5	15,6	16,8	18,2	19,6	21,2	22,9	24,7	26,7	28,8	31,1	-	-	-
80 000	15,6	16,8	18,2	19,6	21,2	22,9	24,7	26,7	28,8	31,1	-	-	-	-
100 000	16,8	18,2	19,6	21,2	22,9	24,7	26,7	28,8	31,1	-	-	-	-	-
200 000	21,2	22,9	24,7	26,7	28,8	31,1	-	-	-	-	-	-	-	-

C/P ratio in dependence on life L_{10} and rotational speed n for cylindrical roller, spherical roller and tapered roller bearings														Tab. 3
Life	Rotational speed n [min ⁻¹]													
L_{10h}	10	16	25	40	63	100	125	160	200	250	320	400	500	630
h														
100	-	-	-	-	-	-	-	-	1,05	1,1	1,21	1,30	1,39	1,49
500	-	-	-	1,05	1,21	1,39	1,49	1,60	1,71	1,83	1,97	2,11	2,26	2,42
1 000	-	-	1,13	1,30	1,49	1,71	1,83	1,97	2,11	2,26	2,42	2,59	2,78	2,97
1 250	-	1,05	1,21	1,39	1,60	1,83	1,97	2,11	2,26	2,42	2,59	2,78	2,97	3,19
1 600	-	1,13	1,30	1,49	1,71	1,97	2,11	2,26	2,42	2,59	2,78	2,97	3,19	3,42
2 000	1,05	1,21	1,39	1,60	1,83	2,11	2,26	2,42	2,59	2,78	2,97	3,19	3,42	3,66
2 500	1,13	1,30	1,49	1,71	1,97	2,26	2,42	2,59	2,78	2,97	3,19	3,42	3,66	3,92
3 200	1,21	1,39	1,60	1,83	2,11	2,42	2,59	2,78	2,97	3,19	3,42	3,66	3,92	4,20
4 000	1,30	1,49	1,71	1,97	2,26	2,59	2,78	2,97	3,19	3,42	3,66	3,92	4,20	4,50
5 000	1,39	1,60	1,83	2,11	2,42	2,78	2,97	3,19	3,42	3,66	3,92	4,20	4,50	4,82
6 300	1,49	1,71	1,97	2,26	2,59	2,97	3,19	3,42	3,66	3,92	4,20	4,50	4,82	5,17
8 000	1,60	1,83	2,11	2,42	2,78	3,19	3,42	3,66	3,92	4,20	4,50	4,82	5,17	5,54
10 000	1,71	1,97	2,26	2,59	2,97	3,42	3,66	3,92	4,20	4,50	4,82	5,17	5,54	5,94
12 500	1,83	2,11	2,42	2,78	3,19	3,66	3,92	4,20	4,50	4,82	5,17	5,54	5,94	6,36
16 000	1,97	2,26	2,59	2,97	3,42	3,92	4,20	4,50	4,82	5,17	5,54	5,94	6,36	6,81
20 000	2,11	2,42	2,78	3,19	3,66	4,20	4,50	4,82	5,17	5,54	5,94	6,36	6,81	7,30
25 000	2,26	2,59	2,97	3,42	3,92	4,50	4,82	5,17	5,54	5,94	6,36	6,81	7,30	7,82
32 000	2,42	2,78	3,19	3,66	4,20	4,82	5,17	5,54	5,94	6,36	6,81	7,30	7,82	8,38
40 000	2,59	2,97	3,42	3,92	4,50	5,17	5,54	5,94	6,36	6,81	7,30	7,82	8,38	8,98
50 000	2,78	3,19	3,66	4,20	4,82	5,54	5,94	6,36	6,81	7,30	7,82	8,38	8,98	9,62
63 000	2,97	3,42	3,92	4,50	5,17	5,94	6,36	6,81	7,30	7,82	8,38	8,98	9,62	10,3
80 000	3,19	3,66	4,20	4,82	5,54	6,36	6,81	7,30	7,82	8,38	8,98	9,62	10,3	11,0
100 000	3,42	3,92	4,50	5,17	5,94	6,81	7,30	7,82	8,38	8,98	9,62	10,3	11,0	11,8
200 000	4,20	4,82	5,54	6,36	7,30	8,38	8,98	9,62	10,3	11,0	11,8	12,7	13,6	14,6

C/P ratio in dependence on life L_{10} and rotational speed n for cylindrical roller, spherical roller and tapered roller bearings															Tab. 3
Life	Rotational speed n [min ⁻¹]														
L_{10h}	800	1000	1250	1600	2000	2500	3200	4000	5000	6300	8000	10000	12500	16000	
h															
100	1,60	1,71	1,83	1,97	2,11	2,26	2,42	2,59	2,78	2,97	3,19	3,42	3,66	3,92	
500	2,59	2,78	2,97	3,19	3,42	3,66	3,92	4,20	4,50	4,82	5,7	5,54	5,94	6,36	
1 000	3,19	3,42	3,66	3,92	4,20	4,50	4,82	5,17	5,54	5,94	6,36	6,81	7,30	7,82	
1 250	3,42	3,66	3,92	4,20	4,50	4,82	5,17	5,54	5,94	6,36	6,81	7,30	7,82	8,38	
1 600	3,66	3,92	4,20	4,50	4,82	5,17	5,54	5,94	6,36	6,81	7,30	7,82	8,38	8,98	
2 000	3,92	4,20	4,50	4,82	5,17	5,54	5,94	6,36	6,81	7,30	7,82	8,38	8,98	9,62	
2 500	4,20	4,50	4,82	5,17	5,54	5,94	6,36	6,81	7,30	7,82	8,38	8,98	9,62	10,3	
3 200	4,50	4,82	5,17	5,54	5,94	6,36	6,81	7,30	7,82	8,38	8,98	9,62	10,3	11,0	
4 000	4,82	5,17	5,54	5,94	6,36	6,81	7,30	7,82	8,38	8,98	9,62	10,3	11,0	11,8	
5 000	5,17	5,54	5,94	6,36	6,81	7,30	7,82	8,38	8,98	9,62	10,3	11,0	11,8	12,7	
6 300	5,54	5,94	6,36	6,81	7,30	7,82	8,38	8,98	9,62	10,3	11,0	11,8	12,7	13,6	
8 000	5,94	6,36	6,81	7,30	7,82	8,38	8,98	9,62	10,3	11,0	11,8	12,7	13,6	14,6	
10 000	6,36	6,81	7,30	7,82	8,38	8,98	9,62	10,3	11,0	11,8	12,7	13,6	14,6	15,6	
12 500	6,81	7,30	7,82	8,38	8,98	9,62	10,3	11,0	11,8	12,7	13,6	14,6	15,6	16,7	
16 000	7,30	7,82	8,38	8,98	9,62	10,3	11,0	11,8	12,7	13,6	14,6	15,6	16,7	17,9	
20 000	7,82	8,38	8,98	9,62	10,3	11,0	11,8	12,7	13,6	14,6	15,6	16,7	17,9	19,2	
25 000	8,38	8,98	9,62	10,3	11,0	11,8	12,7	13,6	14,6	15,6	16,7	17,9	19,2	20,6	
32 000	8,98	9,62	10,3	11,0	11,8	12,7	13,6	14,6	15,6	16,7	17,9	19,2	20,6	-	
40 000	9,62	10,3	11,0	11,8	12,7	13,6	14,6	15,6	16,7	17,9	19,2	20,6	-	-	
50 000	10,3	11,0	11,8	12,7	13,6	14,6	15,6	16,7	17,9	19,2	20,6	-	-	-	
63 000	11,0	11,8	12,7	13,6	14,6	15,6	16,7	17,9	19,2	20,6	-	-	-	-	
80 000	11,8	12,7	13,6	14,6	15,6	16,7	17,9	19,2	20,6	-	-	-	-	-	
100 000	12,7	13,6	14,6	15,6	16,7	17,9	19,2	20,6	-	-	-	-	-	-	
200 000	15,6	16,7	17,9	19,2	20,6	-	-	-	-	-	-	-	-	-	

In arrangements of the axles of road and railway vehicles the nominal life can be expressed by a revised relation in the volume of kilometers travelled.

$$L_{10km} = \left(\frac{C}{P} \right)^P \cdot \frac{\pi \cdot D}{1000}$$

L_{10km} - nominal life [10⁶km]
 D - wheel diameter [m]

Reference Nominal Life Values

In cases, where the life for a given arrangement is not specified in advance, the values in tables 4 and 5 can be considered as adequate.

Reference Nominal Life Values in Operating Hours	Table 4
Machine Type	Nominal Life
	L_{10h}
	h
Devices and tools rarely used	1 000
Household electric appliances, small fans	2 000 to 4 000
Machines for intermittent operation, hand tools, workshop lifting tackles, agricultural machines	4 000 to 8 000
Machines with intermittent operation where high reliability is required, auxiliary power station equipment, belt conveyors, trucks, elevators	8 000 to 15 000
Rolling mills	6 000 to 12 000
Machines operating 8 - 16 hours - stationary electric motors, gear drives, textile machine spindles, plastic material processing machines, printing machines, cranes	15 000 to 30 000
Machine tools in general	20 000 to 30 000
Machines with continuous operation - stationary electric machines, conveying equipment, roller conveyors, pumps, centrifuges, blowers, compressors, hammer mills, crushers, briqueting presses, mine hoists, rope pulleys	40 000 to 60 000
Machines with continuous operation for high operating reliability - power station plants, water works machinery, paper making machines, ship machines	100 000 to 200 000

Reference Nominal Life Values in Kilometers	Table 5
Vehicle Type	Nominal Life
	L_{10km}
	km

Road vehicle wheels :

motor cycles	60 000
passenger cars	150 000 to 250 000
trucks, buses	400 000 to 500 000

Axle box bearings for railway vehicles:

freight wagons (according to UIC) under continuous maximum axle load acting	800 000
tram cars	1 500 000
railway passenger carriages	3 000 000
motor wagons and motor units	3 000 000 to 4 000 000
locomotives	3 000 000 to 5 000 000

Equation of Adjusted Life

Adjusted life is a corrected nominal life, where by calculation not only the load but the influence of bearing components, material, physical, mechanical, and chemical qualities of lubricants and the temperature regime of the bearing, the operating environment are taken into account.

$$L_{na} = a_1 \cdot a_{23} \cdot L_{10}$$

L_{na} - adjusted life for (100-n)% reliability and other usual operation conditions [10⁶ rev]

a_1 - life factor for other than 90% reliability, see Table 6

a_{23} - life factor of material, lubricant, production technology and operation conditions, see Pict. 1

L_{10} - nominal life [10⁶ rev]

Factor a_1 Values		Table 6
Reliability (%)	L_n	a_1
90	L_{10}	1,00
95	L_5	0,62
96	L_4	0,53
97	L_3	0,44
98	L_2	0,33
99	L_1	0,21

We can find basic values of a_{23} by using the diagram in Figure 1.

$$\kappa = \nu / \nu_1$$

ν - kinematic lubricant viscosity by operation bearing temperature [mm².s⁻¹]

ν_1 - kinematic viscosity for defined rotational speed and selected bearing dimensions [mm².s⁻¹]

Values ν and ν_1 are determined according to the diagrams in Figure 23 or 24.

In the diagram, Figure 1, the line I is valid for radial ball bearings operating in a very clean environment. In other cases the factor a_{23} is lower, depending on the environment cleanliness, and the decreasing tendency is dependent on the bearing design group in following order :

- angular contact ball bearings
- tapered roller bearings
- cylindrical roller bearings
- double row self-aligning ball bearings
- spherical roller bearings

Line II can be used when stating the factor a_{23} for spherical roller bearings operating in a dusty environment.

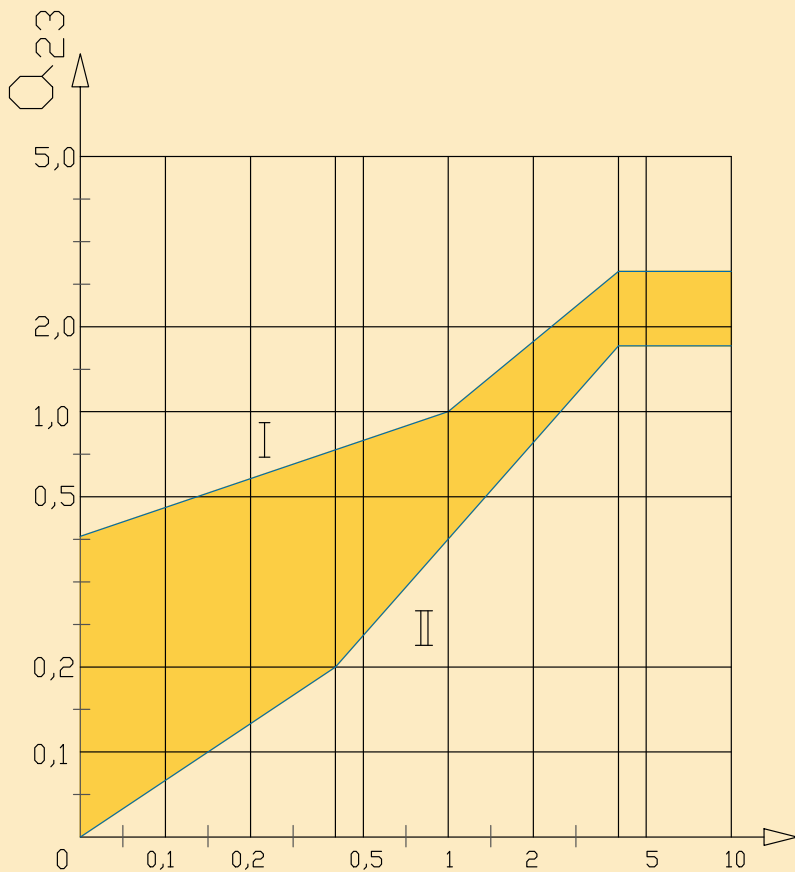

$$\chi = \frac{\nu}{\nu_1}$$

Figure 1

1.1.3 Equivalent Dynamic Load

In the arrangement the bearing is subjected to generally acting forces in various magnitudes, at various rotational speeds and with different acting period. From the point of view of calculation methodology the acting forces should be re-calculated into the constant load, by which the bearing will have the same life as it reaches in the conditions of the actual load. Such a re-calculated constant radial or axial load is called the equivalent load P , or P_r (radial) or P_a (axial).

Combined Load

Constant Load

The outer forces acting on a bearing are not changed both from the point of view of size and time dependence.

Radial Bearings

If the radial bearings are simultaneously subjected to constant forces in radial and axial directions, the following equation is valid for calculating the radial equivalent dynamic load :

$$P_r = X \cdot F_r + Y \cdot F_a \quad [\text{kN}]$$

P_r	- radial equivalent dynamic load	[kN]
F_r	- radial bearing load	[kN]
F_a	- axial bearing load	[kN]
X	- radial load factor	
Y	- axial load factor	

Factors X and Y depend on the ratio F_a/F_r . Values X and Y are shown in the dimension tables or in the introduction to each bearing type where closer information regarding bearing calculation of the respective type is given.

Thrust Bearings

Thrust ball bearings can carry only forces acting in axial direction and the following equation is valid for calculating axial equivalent dynamic load :

$$P_a = F_a \quad [\text{kN}]$$

P_a	- axial equivalent dynamic load	[kN]
F_a	- axial bearing load	[kN]

Spherical roller thrust bearings can also carry some radial load, but only by simultaneous acting of axial load, when condition $F_r \leq 0,55 F_a$ must be fulfilled. Axial equivalent dynamic load is calculated from equation

$$P_a = F_a + 1,2 \cdot F_r \quad [\text{kN}]$$

Fluctuating Load

Real fluctuating load, whose time course we know, is for calculation replaced by mean hypothetical load. This hypothetical load has the same influence on the bearing as the fluctuating load.

Change of Load Magnitude by Constant Rotational Speed

If the bearing is subjected to a load in a constant direction, whose magnitude is changed in dependence on time and the rotational speed is constant (Figure 2), we can calculate the mean hypothetical load F_s according to the following equation

$$F_s = \left(\sum_{i=1}^n F_i^3 \times \frac{q_i}{100} \right)^{\frac{1}{3}} \quad [\text{kN}]$$

F_s - mean hypothetical constant load [kN]

$F_i = F_1, \dots, F_n$ - constant partial actual load [kN]

$q_i = q_1, \dots, q_n$ - share of fractional load effects [%]

At constant rotational speed with linear change of the load in constant direction (see Figure 3) the mean hypothetical load can be calculated from equation

$$F_s = \frac{F_{\min} + 2 \cdot F_{\max}}{3} \quad [\text{kN}]$$

Figure 2

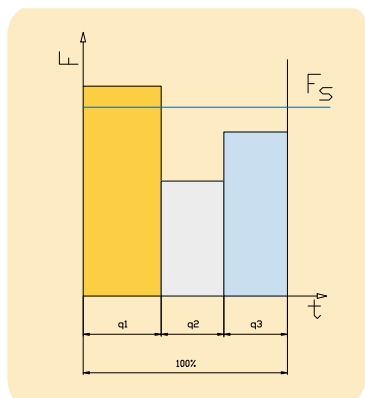
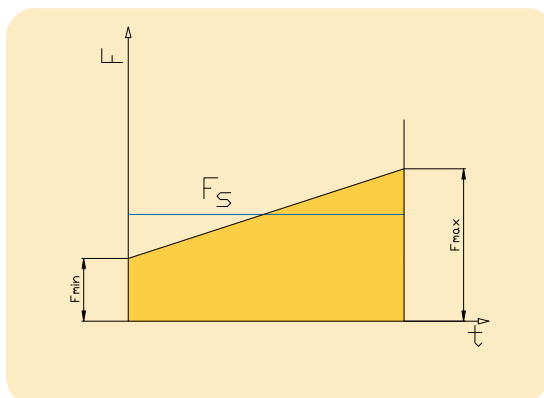

Figure 3



If the actual load has a sine behaviour (see Figure 4), the mean hypothetical load is

$$F_s = 0,75 \cdot F_{\max} \quad [\text{kN}]$$

Change of Load Magnitude by Change of Rotational Speed

If the bearing is subjected in time to a varying load and the rotational speed is being changed, the mean hypothetical load is calculated from equation

$$F_s = \left(\frac{\sum_{i=1}^n F_i^3 \cdot q_i \cdot n_i}{\sum_{i=1}^n q_i \cdot n_i} \right)^{\frac{1}{3}} \quad [\text{kN}]$$

$n_i = n_1, \dots, n_n$ - constant rotational speed in time of partial loads F_1, \dots, F_n acting [min^{-1}]

$q_i = q_1, \dots, q_n$ - share of partial load and rotational speed acting [%]

If in dependence on time only the rotational speed is changed, the mean hypothetical constant rotational speed is calculated from equation

$$n_s = \left(\frac{\sum_{i=1}^n q_i \cdot n_i}{100} \right) \quad [\text{min}^{-1}]$$

n_s = mean rotational speed [min^{-1}]

Oscillating Motion of Bearing

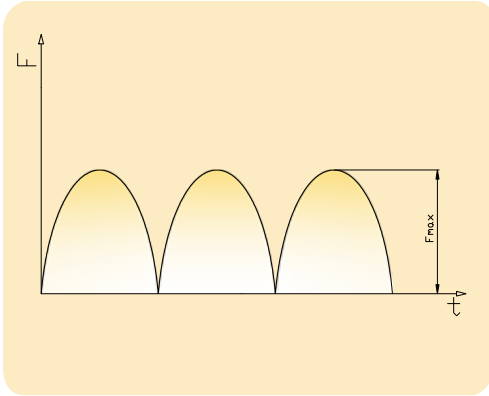

Figure 4

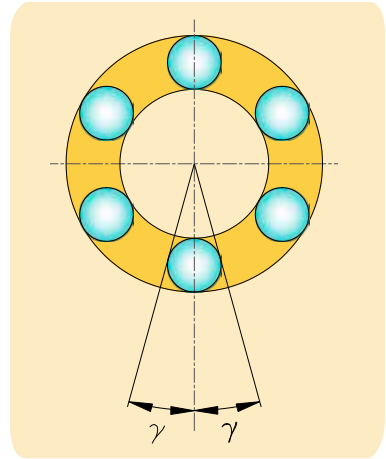

Figure 5

By oscillating motion with amplitude γ (see Figure 5) it is the simplest way of substituting the oscillating motion by hypothetical rotation, when the rotational speed equals the oscillation frequency. For radial bearings the mean hypothetical load is calculated from the equation :

$$F_s = F_r \left(\frac{\gamma}{90} \right)^{\frac{1}{p}} \quad [\text{kN}]$$

- | | | |
|----------|--|------|
| F_s | - mean hypothetical load | [kN] |
| F_r | - actual radial load | [kN] |
| γ | - oscillating motion amplitude | [°] |
| p | - exponent $p = 3$ for ball bearings
$p=10/3$ for cylindrical roller, needle roller, spherical roller and tapered roller bearings | |

1.1.4 Temperature Influence

Delivered bearing assortment is determined for usage in an environment with operating temperatures up to 120°C. Exceptions are double row spherical roller bearings which can work at temperatures up to 180°C, and single row ball bearings with seals (RS, 2RS, RSR, 2RSR) applicable up to 110°C, with seals RS2, -2RS2 applicable up to 150°C.

For higher operation temperatures the bearings are produced so that their necessary physical and mechanical qualities and dimensional stability can be secured.

Values of the basic dynamic load ratings C_r or C_a shown in the dimension tables of this publication should be multiplied by factor f_t , shown in Table 7.

Values of f_t Factor				Table 7
Operating Temperature to [°C]	150	200	250	300
Factor f_t	0,95	0,9	0,75	0,6

1.2 STATIC LOAD

1.2.1 Basic Static Load Rating

Radial basic static load rating C_{Or} and axial basic static load rating C_{Oa} are shown for each bearing in the dimension tables of this publication. Values C_{Or} and C_{Oa} were stated by a calculation according to the standard STN ISO 76.

Basic static load rating is the load which corresponds to calculated contact stresses at the most heavily loaded contact zone of the rolling element and bearing raceway :

- 4 600 MP_a for double row self-aligning ball bearings
- 4 200 MP_a for the other ball bearings
- 4 000 MP_a for cylindrical roller, needle roller, spherical roller and tapered roller bearings

1.2.2 Equivalent Static Load

Equivalent static load is a re-calculated radial load P_{Or} for radial bearings and axial axis load P_{Oa} for thrust bearings.

$$P_{Or} = X_o \cdot F_r + Y_o \cdot F_a \quad [\text{kN}]$$

$$P_{Oa} = X_o \cdot F_r + Y_o \cdot F_a \quad [\text{kN}]$$

P_{Or}	- radial equivalent static load	[kN]
P_{Oa}	- axial equivalent static load	[kN]
F_r	- radial load	[kN]
F_a	- axial load	[kN]
X_o	- radial load factor	
Y_o	- axial load factor	

Factor s_0			Table 8
Bearing motion	Type of load, demands on bearing running	S_0 Ball Bearings	S_0 Cylindrical roller, needle roller, spherical roller, tapered roller bearings
Rotary	distinct impact load, high demands on smooth running	2	4
	after static loading bearing rotates under smaller load	1,5	3
	normal demands on smooth running		
	normal operating conditions and normal demands on running	1	1,5
	smooth impact-free operating	0,5	1
Oscillating	small oscillation angle with high frequency, with uneven impact loading	2	3,5
	large oscillating angle with low frequency and with approximately constant periodic load	1,5	2,5
Non-rotary	distinct impact load	1,5 to 1	3 to 2
	normal and small load, no special demands on bearing operation	1 to 0,4	2 to 0,8
	spherical roller thrust bearings at all kinds of motions and loads	-	4

Factors X_o and Y_o are given for individual bearings in the dimension tables of this publication. Subsequently, closer data for stating the equivalent static load of given bearing type are also given here.

1.2.3 Bearing Safety under Static Load

In practice the bearing safety under static load is found by the ratio C_{or}/P_{or} or C_{oa}/P_{oa} and is compared with data in table 8, where the values of least permissible factors so for various operation conditions are shown.

$$S_0 = \frac{C_{or}}{P_{or}} \quad \text{or} \quad \frac{C_{oa}}{P_{oa}}$$

S_0	- safety factor under static load	
C_{or}	- radial basic static load rating	[kN]
C_{oa}	- axial basic static load rating	[kN]
P_{or}	- radial equivalent static load or maximum acting impact force	
	F_r max (Figure 6) under distinct impact load	[kN]
P_{oa}	- axial equivalent static load or maximum acting impact force	
	F_a max (Figure 6) under distinct impact load	[kN]

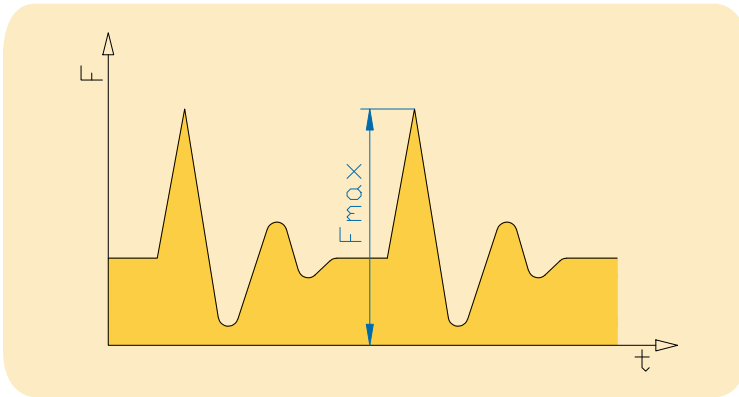

Figure 6

1.3 LIMITING SPEED

Limiting speed depends on the bearing type, its accuracy, cage design, internal clearance, operating conditions in arrangement, kind of lubrication and on other factors. This influence summary determines the heat generation in the bearing and also limited rotational speed which is first of all limited by the lubricant operating temperature. For orientation, limiting rotational speed values are shown in the dimension tables for individual bearings in normal tolerance class, both for grease and oil lubrication. Given values are valid under pre-sumption of adequate load ($L_{10h} \geq 100\,000$ h), normal operating conditions and cooling.

It is also necessary to reduce the limiting speed values for radial bearings which are permanently loaded by relatively great axial force. The resulting limiting speed values depend on the ratio of axial and radial load F_a/F_r .

The shown limiting speed can be exceeded for ball bearings up to 3 times, cylindrical roller bearings up to 2 times, for other bearings except spherical roller and tapered roller bearings up to 1.5 times and for spherical roller bearings 1.3 times.

This exceeding requires :

- adaptation of lubrication and cooling
- higher bearing tolerance class and corresponding accuracy of the abutment parts
- higher radial clearance than normal
- cage of suitable design and material

2. ROLLING BEARING DESIGN DATA

2.1 BOUNDARY DIMENSIONS

Bearings introduced in this publication are made in dimensions that are in accordance with the international standards ISO 15, ISO 355 and ISO 104. In the dimensional plan each bearing bore diameter d corresponds to several outer diameters D and various widths are added to them - B or T for radial and H for thrust bearings. Bearings having the same bore diameter and outer diameter belong to one diameter series which is designated according to the ascending outer diameter by figures 7,8,9,0,1,2,3,4. Within each diameter series there are bearings of various width series according to the ascending width : 8, 0, 1, 2, 3, 4, 5, 6 for radial bearings and 7,9,1,2 for thrust bearings. Diameter and width series form dimension series which are designated by a two digit number, where the first digit indicates the width series and the second the diameter one, as shown in Figure 7.

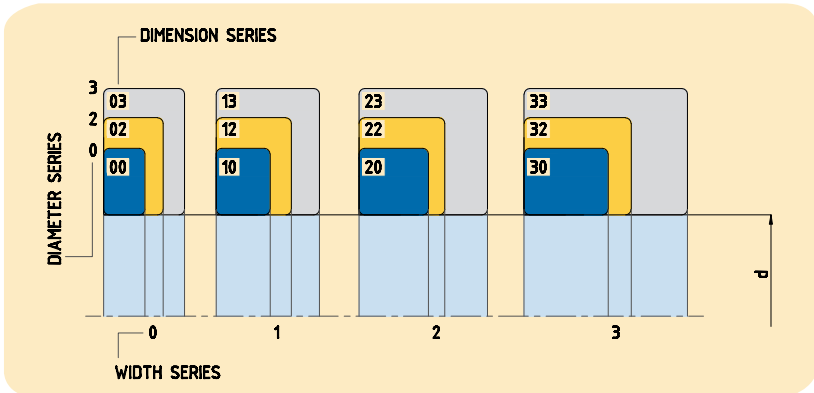

Figure 7

Dimensional plan also includes the bearing ring chamfer dimensions, so called mounting chamfer, see Figure 8.

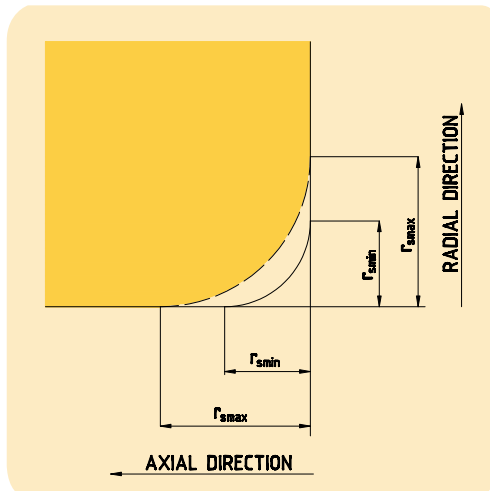
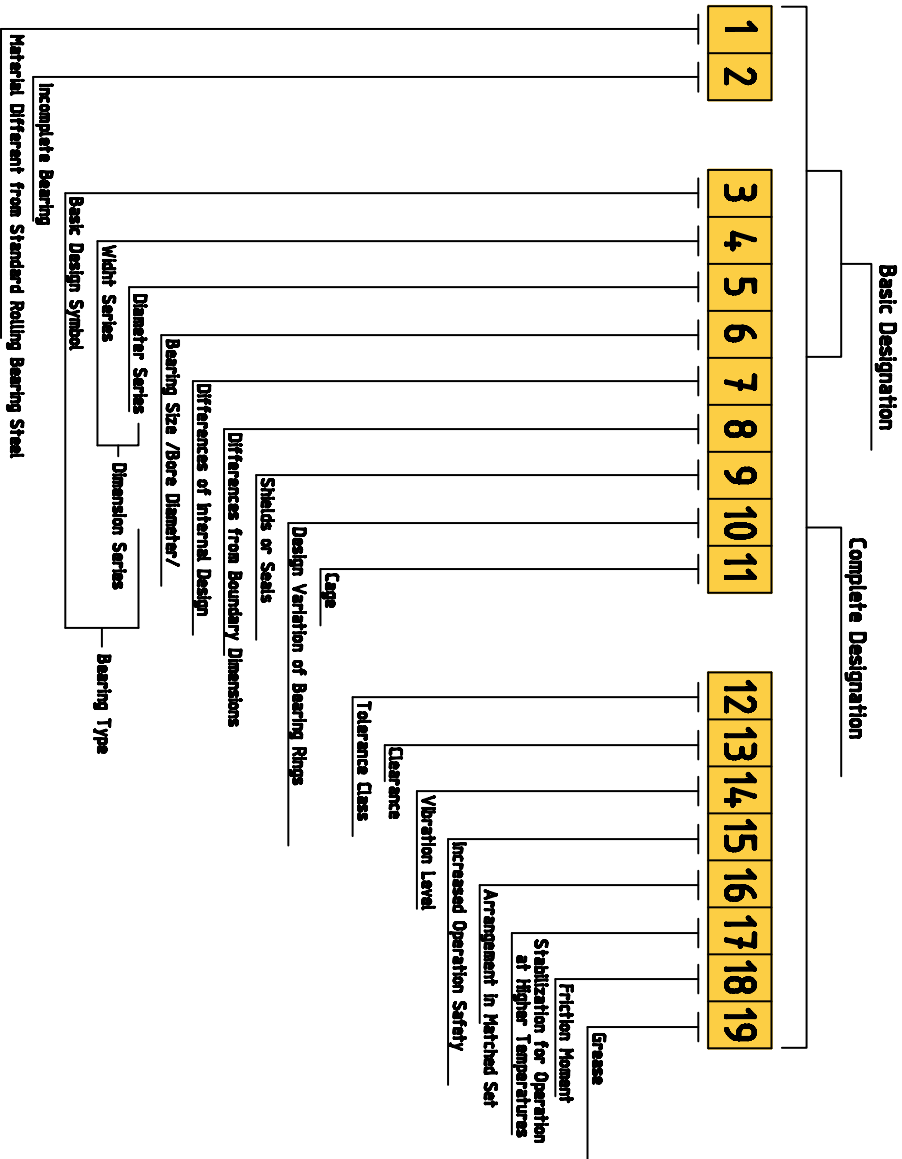

Figure 8

Overview of chamfer limiting values according to international standard ISO 582 is given in Table 9.

Limiting Dimensions of Mounting Chamfer									Table 9
Radial Bearings except Tapered Roller Bearings					Tapered Roller Bearings				Thrust Bearings
r_s min	d or D		r_s max		d or D		r_s max		r_s max
	Over	Incl.	In Radial Direction	In Axial Direction	Over	Incl.	In Radial Direction	In Axial Direction	
mm									
0,15	-	-	0,3	0,6	-	-	-	-	0,3
0,2	-	-	0,5	0,8	-	-	-	-	0,5
0,3	-	40	0,6	1	-	40	0,7	1,4	0,8
	40	-	0,8	1	40	-	0,9	1,6	0,8
0,6	-	40	1	2	-	40	1,1	1,7	1,5
	40	-	1,3	2	40	-	1,3	2	1,5
1	-	50	1,5	3	-	50	1,6	2,5	2,2
	50	-	1,9	3	50	-	1,9	3	2,2
1,1	-	120	2	3,5	-	-	-	-	2,7
	120	-	2,5	4	-	-	-	-	2,7
1,5	-	120	2,3	4	-	120	2,3	3	3,5
	120	-	3	5	120	250	2,8	3,5	3,5
	-	-	-	-	250	-	3,5	4	3,5
2	-	80	3	4,5	-	120	2,8	4	4
	80	220	3,5	5	120	250	3,5	4,5	4
	220	-	3,8	6	250	-	4	5	4
2,1	-	280	4	6,5	-	-	-	-	4,5
	280	-	4,5	7	-	-	-	-	4,5
2,5	-	100	3,8	6	-	120	3,5	5	-
	100	280	4,5	6	120	250	4	5,5	-
	280	-	5	7	250	-	4,5	6	-
3	-	280	5	8	-	120	4	5,5	5,5
	280	-	5,5	8	120	250	4,5	6,5	5,5
	-	-	-	-	250	400	5	7	5,5
	-	-	-	-	400	-	5,5	7,5	5,5
4	-	-	6,5	9	-	120	5	7	6,5
	-	-	-	-	120	250	5,5	7,5	6,5
	-	-	-	-	250	400	6	8	6,5
	-	-	-	-	400	-	6,5	8,5	6,5
5	-	-	8	10	-	180	6,5	8	8
	-	-	-	-	180	-	7,5	9	8
6	-	-	10	13	-	180	7,5	10	10
	-	-	-	-	180	-	9	11	10
7,5	-	-	12,5	17	-	-	-	-	12,5
9,5	-	-	15	19	-	-	-	-	15
12	-	-	18	24	-	-	-	-	18
15	-	-	21	30	-	-	-	-	21

2.2 DESIGNATION



Bearing designation is created by numerical and letter symbols indicating the type, size and design of the bearing, see the scheme. In the basic design the bearings are designated by a basic designation which consists of bearing type and size designation. The type designation is usually created by the symbol indicating the bearing design (see position 3 in the scheme) and the symbol for dimension series or diameter series (positions 4 and 5 in the scheme), e.g. bearing type 223, 302, NJ22, 511, 62, 12, etc. Bearing size designation is created by symbols for the nominal bore diameter d (see position 6 in the scheme).

Bearings with bore diameter $d < 10$ mm :

Digit separated by a slash, or the last digit indicates directly the bore dimension in mm, e.g. 619/2, 624.

Bearings with bore diameter $d = 10$ to 17 mm :

double digit number 00 indicates bore $d = 10$ mm, e.g. 6200

01 $d = 12$ mm, e.g. 51101

02 $d = 15$ mm, e.g. 3202

03 $d = 17$ mm, e.g. 6303

An exception to the designation are separable single row ball bearings - types E and BO, where the double digit number indicates directly the bore diameter in mm, e.g. E17.

Bearings with bore diameter $d = 20$ to 480 mm :

Bore diameter is fivefold of the last double digit number, e.g. bearing 1320 has the bore diameter $d = 20 \times 5 = 100$.

An exception create bearings with bore $d = 22, 28,$ and 32 mm, where the double digit number separated by a slash indicates directly the bore diameter in mm, e.g. 320/32AX, further separable single row ball bearings - type E and single row cylindrical roller bearings - type NG, where the double digit number, or number indicates directly the bore diameter in mm, e.g. : E20, NG160 C4SO.

Bearings with bore diameter $d = 500$ mm :

The last three or four digit number separated by a slash indicates directly the bore diameter in mm, e.g. 230/530M, NU29/1060.

Bearings produced in different design than standard are designated by so called complete designation, see the scheme. It consists of the basic designation and prefixes and suffixes indicating the difference from the basic design.

Meaning of Prefixes and Suffixes

In compliance with complete designation a survey and meaning of used prefixes and suffixes is given in the following part. (Number in brackets at individual groups corresponds to the position number in the scheme).

Prefixes

Material Different from Standard Bearing Steel (1)

X corrosion resisiting steel, e.g. X 623

T case hardened steel, e.g. T 32240

Incomplete Bearing (2)

L	removable ring of separable bearing, e.g. L NU206, for thrust ball bearings without shaft washer, e.g. L 51215
R	separable bearing without removable ring, e.g. R NU206 or R N310
E	single shaft washer of thrust roller bearing, e.g. E 51314
W	single housing washer of thrust ball bearing, e.g. W 51411
K	cage with rolling elements, e.g. K NU320

Suffixes

Difference of Internal Design (7)

A	single row angular contact ball bearing, contact angle $\alpha = 25^\circ$, e.g. B7205ATB P5 single row tapered roller bearing with higher load rating and higher limiting speed, e.g. 30206A thrust ball bearing with higher limiting speed, e.g. 51105A
AA	single row angular contact ball bearing with contact angle $\alpha = 26^\circ$, e.g. B72010AATB P4
B	single row angular contact ball bearing with contact angle $\alpha = 40^\circ$, e.g. 7304B single row tapered roller bearing with contact angle $\alpha > 17$, e.g. 32315B
BE	single row angular contact ball bearing with contact angle $\alpha = 40^\circ$, in new design, e.g. 7310BETNG
C	Single row angular contact ball bearing with contact angle $\alpha = 15^\circ$, e.g. B7202CTB P4 double row spherical roller bearing in new design, e.g. 22216C
CA	single row angular contact ball bearing with contact angle $\alpha = 12^\circ$, e.g. B7202CATB P5
CB	single row angular contact ball bearing with contact angle $\alpha = 10^\circ$, e.g. B7206CBTB P4
CC	double row spherical roller bearing in new design, e.g. 23996CCM
D	single row ball bearing - type 160 with higher load rating, e.g. 16004D
E	single row cylindrical roller bearing with higher load rating, e.g. NU209E double row spherical roller bearing with higher load rating, e.g. 22215E spherical roller thrust bearing with higher load rating, e.g. 29416EJ

Difference of Boundary Dimensions

X	change of boundary dimensions, introduced by new international standards, e.g. 32028AX
---	--

Shields or Seals

RS	seal on one side, e.g. 6304RS
-2RS	seals on both sides, e.g. 6204-2RS
RSN	seal on one side and snap ring groove in outer ring opposite to seal side, e.g. 6306RSN
RSNB	seal on one side and snap ring groove in outer ring on the same side as seal, e.g. 6210RSNB
-2RSN	seals on both sides and snap ring groove in outer ring, e.g. 6310-2RSN
RSR	seal on one side adhering to flat surface of inner ring, e.g. 624RSR
-2RSR	seals on both sides adhering to flat surface of inner ring, e.g. 608-2RSR
Z	metal shield on one side, e.g. 6206Z
-ZZ	metal shields on both sides, e.g. 6304-ZZ
ZN	metal shield on one side and snap ring groove in outer ring opposite to metal shield, e.g. 6208ZN
ZNB	metal shield on one side and snap ring groove in outer ring on the same side as shield, e.g. 6306ZNB
-ZZN	metal shields on both sides and snap ring groove in outer ring, e.g. 6208-ZZN
ZR	metal shield on one side adhering to flat surface of inner ring, e.g. 608ZR
-ZZR	metal shields on both sides adhering to flat surface of inner ring, e.g. 608-ZZR

Bearing Ring Design Variation (10)

K	tapered bore, taper 1:12, e.g. 1207K
K30	tapered bore, taper 1:30, e.g. 24064K30M
N	snap ring groove in outer ring, e.g. 6308N
NR	snap ring groove in outer ring and inserted snap ring, e.g. 6310NR
NX	snap ring groove in outer ring whose boundary dimensions do not correspond to STN 02 4605, e.g. 6210NX
D	split inner ring, e.g. 3309D
W33	groove and lubrication holes in bearing outer ring surface, e.g. 23148W33M
O	lubrication grooves in bearing outer ring, e.g. NU1014O

Cages (11)

Cage material for bearings in basic design is not usually indicated.

J	pressed steel cage, rolling element centred, e.g. 6034J
J2	pressed steel cage, rolling element centred, new design for single row tapered roller bearings, e.g. 30206AJ2
Y	pressed brass cage, rolling elements centred, e.g. 6001Y
F	machined steel cage, rolling elements centred, e.g. 6418F
L	machined light metal cage, rolling elements centred, e.g. NG180L C3S0
M	machined brass or bronze cage, rolling elements centred, e.g. NU330M
T	machined cage made of textite, rolling elements centred, e.g. 6005T P5
TN	machined cage made of polyamide or similar plastic, rolling elements centred, e.g. 6207TN
TNG	machined cage made of polyamide or similar plastic with glass fibres, rolling elements centred, e.g. 2305TNG

Cage design

(introduced symbols are always used in connection with cage material symbols).

A	cage centred on outer ring, e.g. NU226MA
B	cage centred on inner ring, e.g. B7204CATBP5
P	machined window-type cage, e.g. NU1060MAP
H	one-piece open-type cage, e.g. 629TNH
S	cage with lubrication grooves, e.g. NJ418MAS
V	bearing without cage, full rolling element number, e.g. NU209V

Tolerance Class (12)

P0	standard tolerance class (not indicated), e.g. 6204
P6	higher tolerance class than standard, e.g. 6322 P6
P5	higher tolerance class than P6, e.g. 6201 P5
P5A	in some parameters higher tolerance class than P5, e.g. 6006TB P5A
P4	higher tolerance class than P5, e.g. B7204CBTB P4
P4A	in some parameters higher tolerance class than P4, e.g. B7205CATB P4A
P2	higher tolerance class than P4, e.g. B7205CATB P2
P6E	higher tolerance class for rotating electric machines, e.g. 6204 P6E
P6X	higher tolerance class for single row tapered roller bearings, e.g. 30210A P6X
SP	higher tolerance class for cylindrical roller bearings with tapered bore, e.g. NN3022K SPC2NA
UP	higher tolerance class than SP for cylindrical roller bearings with tapered bore, e.g. N1016 UPC1NA

Clearances (13)

C2	clearance less than normal, e.g. 608 C2 normal clearance (not indicated), e.g. 6204
C3	clearance greater than normal, e.g. 6310 C3
C4	clearance greater than C3, e.g. NU320M C4
C5	clearance greater than C4, e.g. 22330M C5
NA	radial clearance for bearings with non-interchangeable rings (always after radial clearance symbol), e.g. NU215 P63NA
R...	radial clearance in non-standardized range (range in μm), e.g. 6210A R10-20
A...	axial clearance in non-standardized range (range in μm), e.g. 3210 A20-30

Vibration Level (14)

C6	reduced vibration level lower than normal (not indicated) e.g. 6304 C6
C06	reduced vibration level lower than C6, e.g. 6205 C06
C66	reduced vibration level lower than C06, e.g. 6205 C66

Concrete C06 and C66 values are determined after negotiations between customer and supplier.

Note: Bearings in tolerance class P5 and higher have vibration level C6.

Increased Operation Safety

C7, C8, C9	- bearings with increased operation safety determined primarily for aircraft industry, e.g. 16008 C8
------------	--

Symbol Combination (12 - 15)

Symbols for tolerance class, bearing internal clearances, vibration levels and increased operation safety are combined, when symbol C is omitted from the second and following special bearing characteristics, e.g.:

P6 + C3 = P63 e.g. 6211 P63

P6 + C8 = P68 e.g. 16002 P68

C3 + C6 = C36 e.g. 6303-2RS C36

P5 + C3 + C9 = P539 e.g. 6205MA P539

P6 + C2NA + C6 = P626NA e.g. NU1038 P626NA

Bearing Arrangement in Matched Set (16)

Designation of the arrangement in matched sets of two, three or four bearings consists of symbols indicating the bearing arrangement and symbols determining internal clearance, or preload of matched bearings. Besides symbols shown in the table also U symbol is used and it indicates that respective bearings can be universally matched, e. g. B7003CTA P4UL.

Internal Clearance or Preload

Introduced symbols are always used in combination with matching symbols.

- A bearing matching with clearance, e.g. 7305OA
- O bearing matching without clearance, e.g. 7305 P6XO
- L bearing matching with light preload, e.g. B7205CATB P4UL
- M bearing matching with medium preload, e.g. B7204CATB P5XM
- S bearing matching with great preload, e.g. B7304AATB P4OS

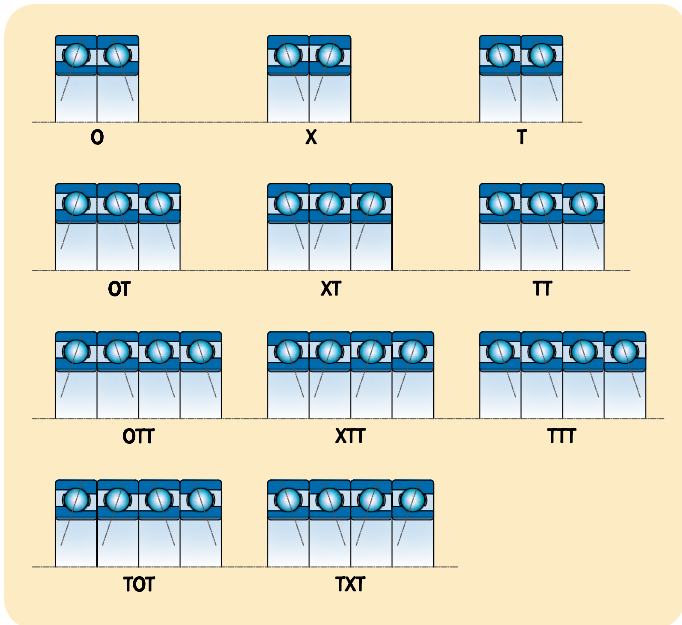

Stabilization for Operation at Higher Temperature

Both rings have stabilized dimensions for operation at higher temperature

- S0 for operating temperature up to 150° C
- S1 up to 200° C
- S2 up to 250° C
- S3 up to 300° C
- S4 up to 350° C
- S5 up to 400° C

Designation example - NG160LB C4S3.

Friction Moment (18)

- JU reduced friction moment, e.g. 619/2 JU
- JUA bearings with determined friction moment for starting up, e.g. 623 JUA
- JUB bearings with determined friction moment for running out, e.g. 623 JUB

Grease (19)

For designation of bearings with shields or seals on both sides, filled with grease different from the standard one, symbol combinations are used for designation. The first two symbols determine the operating temperature range and the third (a letter) the name or type of lubricant, according to producer's specifications, or another symbol (a digit) determines the grease volume, which the sealed or shielded inner bearing's space is filled with.

- TL grease for low operating temperatures from -60°C to +100°C,
designation example 6302-2RS TL
- TM grease for medium operating temperatures from -35°C to +140°C,
designation example 6204-2ZR TM
- TH grease for high operating temperatures from -30°C to +200°C,
designation example 6202-2Z TH
- TW grease for both low and high operating temperatures from -40°C to +150°C,
designation example 6310-2Z C4TW

Note: Symbol TM needs not be marked on bearings and packages.

DESIGNATION SCHEME

OF NON-STANDARDIZED BEARINGS

Symbol for special rolling bearings

Design group or rolling bearing type

- 0 - single row ball
- 1 - double row ball
- 2 - axial ball
- 4 - cylindrical, needle and single row spherical
- 5 - cylindrical, needle, double and multi row spherical
- 6 - single row, double row and four row tapered
- 7 - spindles
- 8 - assembling units and single parts
- 9 - axial cylindrical, needle, spherical and tapered

Dimension group 1 – 12 according to the outer diameter D

Ordinal number in the corresponding dimension group

Difference of the inner design

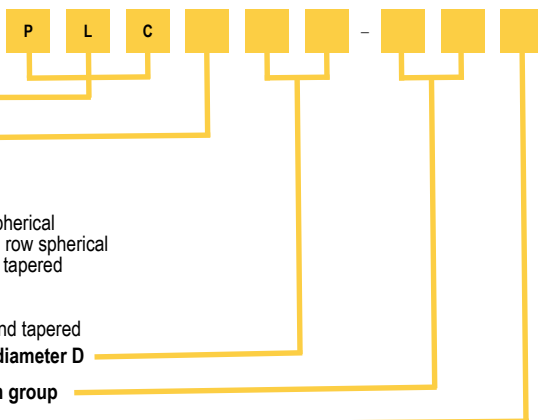

2.3 TOLERANCE

Under bearing tolerance, dimension and operation accuracy is understood. Bearings are manufactured in tolerance classes P0, P6, P5A, P4, P4A, P2, SP and UP. Tolerance class P0 is the basic one and a decreasing number in designation means a higher bearing tolerance class. Limiting values for dimension and operation accuracy shown in tables 20 to 30 are in accordance with the standard ISO 492 and ISO 199 (STN 02 4612). Designation P5A and P4A are used for bearings manufactured in corresponding tolerance class (P5, P4), or selected parameters are in higher tolerance class than P5 and P4.

Tolerance Symbols and Their Meaning

d	nominal bore diameter
d_1	nominal diameter of larger theoretical tapered bore diameter
d_2	nominal diameter of the shaft washer of double direction thrust bearings
ds	deviation of single bore diameter from nominal
Δ_{dmp}	mean cylindrical bore diameter deviation in single radial plane (for tapered bore Δ_{dmp} is valid for theoretical bore diameter)
Δ_{d1mp}	deviation of mean larger theoretical diameter of tapered bore
Δ_{d2mp}	mean shaft washer bore diameter deviation of double direction thrust bearings in single radial plane
V_{dp}	single bore diameter variation in single radial plane
V_{dmp}	mean cylindrical bore diameter variation
V_{d2p}	shaft washer bore diameter variation of double direction thrust bearings in single radial plane
D	nominal outside diameter
Δ_{Ds}	deviation of single outside diameter from the nominal dimension
Δ_{Dmp}	mean outside cylindrical surface diameter deviation in single plane
V_{Dp}	single outside cylindrical surface diameter variation in single radial plane
V_{Dmp}	mean outside cylindrical surface diameter variation
B	inner ring nominal width
T	total nominal width of tapered roller bearings
T_1	nominal effective width of cup sub-unit
T_2	nominal effective width of cone sub-unit
Δ_{Bs}	inner ring single width deviation
Δ_{Cs}	outer ring single width deviation
Δ_{Ts}	bearing single width deviation (total)
Δ_{T1s}	cone sub-unit effective width deviation
Δ_{T2s}	cup sub-unit effective width deviation
C	outer ring nominal width
V_{Bs}	inner ring single width variation
V_{Cs}	outer ring single width variation
K_{ia}	radial runout of assembled bearing inner ring
K_{ea}	radial runout of assembled bearing outer ring
S_i	shaft washer raceway axial runout
S_e	housing washer raceway axial runout
S_{ia}	inner ring flat seat face axial runout of assembled bearing
S_{ea}	outer ring flat seat face axial runout of assembled bearing
S_d	flat seat face axial runout
S_D	runout of outside cylindrical surface towards outer ring face
S_s	runout of supporting face towards seat face for single row tapered roller bearings

Dimension and Running Accuracy of Radial Bearings (except Tapered Roller Bearings)

Tab. 10

Tolerance Class P0																
Inner Ring																
d		Cylindrical Bore								Tapered Bore						
		Δ_{dmp}		V_{dp}			V_{dmp}	K_{ia}	Δ_{Bs}		V_{Bs}	Δ_{dmp}		$\Delta_{d'imp} \cdot \Delta_{dmp}$		V_{dp1}
				Diameter Series												
over	incl.	max	min	max	max	max	max	max	min	max	max	min	max	min	max	
mm		μm														
2,5	10	0	-8	10	8	6	6	10	0	-120	15	-	-	-	-	-
10	18	0	-8	10	8	6	6	10	0	-120	20	-	-	-	-	-
18	30	0	-10	13	10	8	8	13	0	-120	20	+21	0	+21	0	13
30	50	0	-12	15	12	9	9	15	0	-120	20	+25	0	+25	0	15
50	80	0	-15	19	19	11	11	20	0	-150	25	+30	0	+30	0	19
80	120	0	-20	25	25	15	15	25	0	200	25	+35	0	+35	0	25
120	180	0	-25	31	31	19	19	30	0	-250	30	+40	0	+40	0	31
180	250	0	-30	38	38	23	23	40	0	-300	30	+46	0	+46	0	38
250	315	0	-35	44	44	26	26	50	0	-350	35	+52	0	+52	0	44
315	400	0	-40	50	50	30	30	60	0	-400	40	+57	0	+57	0	50
400	500	0	-45	56	56	34	34	65	0	-450	50	+63	0	+63	0	56
500	630	0	-50	63	63	38	38	70	0	-500	60	-	-	-	-	-
630	800	0	-75	-	-	-	-	80	0	-750	70	-	-	-	-	-
800	1000	0	-100	-	-	-	-	90	0	-1000	80	-	-	-	-	-
1000	1250	0	-125	-	-	-	-	100	0	-1250	100	-	-	-	-	-

Outer Ring															
D		Δ_{Dmp}		V_{DP}				V_{Dmp}	K_{ea}	$\Delta V_{Cs} \Delta_{Cs}$					
				Diameter Series											
		over	incl.	max	min	max	max	max	max	max					
mm		μm													
6	18	0	-8	10	8	6	10	6	15	Corresponds to Δ_{Bs}, V_{Bs} of the same bearing inner ring					
18	30	0	-9	12	9	7	12	7	15						
30	50	0	-11	14	11	8	16	8	20						
50	80	0	-13	16	13	10	20	10	25						
80	120	0	-15	19	19	11	26	11	35						
120	150	0	-18	23	23	14	30	14	40						
150	180	0	-25	31	31	19	38	19	45						
180	250	0	-30	38	38	23	-	23	50						
250	315	0	-35	44	44	26	-	26	60						
315	400	0	-40	50	50	30	-	30	70						
400	500	0	-45	56	56	34	-	34	80						
500	630	0	-50	63	63	38	-	38	100						
630	800	0	-75	94	94	55	-	55	120						
800	1000	0	-100	125	125	75	-	75	140						
1000	1250	0	-125	-	-	-	-	-	160						
1250	1600	0	-160	-	-	-	-	-	190						

1) Valid in any bore radial plane

2) Valid only for bearings in diameter series 2, 3 and 4

Dimension and Running Accuracy of Radial Bearings (except Tapered Roller Bearings)															Tab. 11	
Tolerance Class P6																
Inner Ring																
d		Cylindrical Bore									Tapered Bore					
		Δ_{dmp}		V_{dp}			V_{dmp}	K_{ia}	Δ_{Bs}		V_{Bs}	Δ_{dmp}		$\Delta_{d1mp} \cdot \Delta_{dmp}$		$V_{dp}^{(1)}$
				Diameter Series												
over	incl.	max	min	max	max	max	max	max	min	max	max	min	max	min	max	
mm		μm														
2,5	10	0	-7	9	7	5	5	6	0	-120	15	-	-	-	-	-
10	18	0	-7	9	7	5	5	7	0	-120	20	-	-	-	-	-
18	30	0	-8	10	8	6	6	8	0	-120	20	+21	0	+21	0	13
30	50	0	-10	13	10	8	8	10	0	-120	20	+25	0	+25	0	15
50	80	0	-12	15	15	9	9	10	0	-150	25	+30	0	+30	0	19
80	120	0	-15	19	19	11	11	13	0	-200	25	+35	0	+35	0	25
120	180	0	-18	23	23	14	14	18	0	-250	30	+40	0	+40	0	31
180	250	0	-22	28	28	17	17	20	0	-300	30	+46	0	+46	0	38
250	315	0	-25	31	31	19	19	25	0	-350	35	+52	0	+52	0	44
315	400	0	-30	38	38	23	23	30	0	-400	40	+57	0	+57	0	50
400	500	0	-35	44	44	26	26	35	0	-450	45	+63	0	+63	0	56
500	630	0	-40	50	50	30	30	40	0	-500	50	+70	0	+70	0	70

Dimension and Running Accuracy of Radial Bearings (except Tapered Roller Bearings)															Tab. 12a			
Tolerance Class P5																		
Inner Ring																		
d		Cylindrical Bore									Tapered Bore							
		Δ_{dmp}		V_{dp}			V_{dmp}	K_{ia}	S_d	$S_{is}^{(1)}$	Δ_{Bs}		V_{Bs}	Δ_{dmp}		$\Delta_{d1mp} \cdot \Delta_{dmp}$		$V_{dp}^{(1)}$
				Diameter Series														
over	incl.	max	min	max	max	max	max	max	max	min	max	max	min	max	min	max		
mm		μm																
2,5	10	0	-5	5	4	3	4	7	7	0	-40	5	-	-	-	-		
10	18	0	-5	5	4	3	4	7	7	0	-80	5	-	-	-	-		
18	30	0	-6	6	5	3	4	8	8	0	-120	5	+13	0	+13	0	13	
30	50	0	-8	8	6	4	5	8	8	0	-120	5	+16	0	+16	0	15	
50	80	0	-9	9	7	5	5	8	8	0	-150	6	+19	0	+19	0	19	
80	120	0	-10	10	8	5	6	9	9	0	-200	7	+22	0	+22	0	22	
120	180	0	-13	13	10	7	8	10	10	0	-250	8	+25	0	+25	0	25	
180	250	0	-15	15	12	8	10	11	13	0	-300	10	+29	0	+29	0	29	
250	315	0	-18	18	14	9	13	13	15	0	-350	13	+32	0	+32	0	32	
315	400	0	-23	23	18	12	15	15	20	0	-400	15	+36	0	+36	0	36	

Outer Ring											
D		Δ_{Dmp}		V_{Dp}				V_{Dmp}	K_{ea}	ΔV_{cs} Δ_{cs}	
				Diameter Series							
				7,8,9	0,1	2,3,4	bearings ²⁾ with seals				
over	incl.	max	min	max	max	max	max	max	max		
mm		μm									Corresponds to Δ_{Bs} , V_{Bs} of the same bearing inner ring
6	18	0	-7	9	7	5	9	5	8		
18	30	0	-8	10	8	6	10	6	9		
30	50	0	-9	11	9	7	13	7	10		
50	80	0	-11	14	11	8	16	8	13		
80	120	0	-13	16	16	10	20	10	18		
120	150	0	-15	19	19	11	25	11	20		
150	180	0	-18	23	23	14	30	14	23		
180	250	0	-20	25	25	15	-	15	25		
250	315	0	-25	31	31	19	-	19	30		
315	400	0	-28	35	35	21	-	21	35		
400	500	0	-33	41	41	25	-	25	40		
500	630	0	-38	48	48	29	-	29	50		
630	800	0	-45	56	56	34	-	34	60		
800	1000	0	-50	75	75	45	-	45	75		

1) Valid in any bore radial plane

2) Valid only for bearings in diameter series 2, 3 and 4

Outer Ring											Tab. 12b	
D		Δ_{Dmp}		V_{Dp}		V_{Dmp}	K_{ea}	S_D	$S_{ea}^{2)}$	Δ_{cs}	V_{Cs}	
				Diameter Series ³⁾								
				7, 8, 9	0, 1, 2, 3, 4						max	max
over	incl.	max	min	max	max	max	max	max	max	max		
mm		μm									Corresponds to Δ_{Bc} of the same bearing inner ring	
6	18	0	-5	5	4	3	5	8	8			5
18	30	0	-6	6	5	3	6	8	8			5
30	50	0	-7	7	5	4	7	8	8			5
50	80	0	-9	9	8	5	8	8	10			6
80	120	0	-10	10	8	5	10	9	11			8
120	150	0	-11	11	8	6	11	10	13			8
150	180	0	-13	13	10	7	13	10	14			8
180	250	0	-15	15	11	8	15	11	15			10
250	315	0	-18	18	14	9	18	13	18			11
315	400	0	-20	20	15	10	20	13	20			13
400	500	0	-23	23	17	12	23	15	23			15
500	630	0	-28	28	21	14	25	18	25			18
630	800	0	-35	35	26	18	30	20	30		20	

1) Valid only for ball bearings

2) Not valid for shielded or sealed bearings

3) Not valid for shielded or sealed bearings

Dimension and Running Accuracy of Radial Bearings (except Tapered Roller Bearings)													Tab. 13a	
Tolerance Class P4														
Inner Ring														
d		Δ_{dmp}		$\Delta_{ds^{(1)}}$		V_{dp}		V_{dmp}	K_{ia}	S_d	$S_{ia^{(2)}}$	Δ_{Bs}		V_{Bs}
						Diameter Series								
						7, 8, 9	0, 1, 2, 3, 4							
over	incl.	max	min	max	min	max	max	max	max	max	max	max	min	max
mm		μm												
2,5	10	0	-4	0	-4	4	3	2	2,5	3	3	0	-40	2,5
10	18	0	-4	0	-4	4	3	2	2,5	3	3	0	-80	2,5
18	30	0	-5	0	-5	5	4	2,5	3	4	4	0	-120	2,5
30	50	0	-6	0	-6	6	5	3	4	4	4	0	-120	3
50	80	0	-7	0	-7	7	5	3,5	4	5	5	0	-150	4
80	120	0	-8	0	-8	8	6	4	5	5	5	0	-200	4
120	180	0	-10	0	-10	10	8	5	6	6	7	0	-250	5
180	250	0	-12	0	-12	12	9	6	8	7	8	0	-300	6

Dimension and Running Accuracy of Cylindrical Roller Bearings with Tapered Bore											Tab. 14a	
Tolerance Class SP												
Inner Ring												
d		Δ_{dmp}		$\Delta_{d1mp} - \Delta_{dmp}$		V_{dp}		K_{ia}	S_d	Δ_{Bs}		V_{Bs}
over	incl.	max	min	max	min	max	max	max	max	max	min	max
mm		μm										
18	30	+10	0	+4	0	3	3	8	0	-100		5
30	50	+12	0	+4	0	4	4	8	0	-120		5
50	80	+15	0	+5	0	5	4	8	0	-150		6
80	120	+20	0	+6	0	5	5	9	0	-200		7
120	180	+25	0	+8	0	7	6	10	0	-250		8
180	250	+30	0	+10	0	8	8	11	0	-300		10
250	315	+35	0	+12	0	9	10	13	0	-350		13
315	400	+40	0	+13	0	12	12	15	0	-400		15
400	500	+45	0	+15	0	14	12	18	0	-450		25

Outer Ring												Tab. 13b	
D		Δ_{Dmp}		$\Delta_{Ds}^{1)}$		V_{Dp}		V_{Dmp}	K_{ea}	S_D	$S_{ea}^{2)}$	Δ_{Cs}	V_{Cs}
						Diameter Series ³⁾							
						7, 8, 9	0, 1, 2, 3, 4						
over	incl.	max	min	max	min	max	max	max	max	max	max	max	
mm		μm											
6	18	0	-4	0	-4	4	3	2	3	4	5	Corresponds to Δ_{Bs} of the same bearing inner ring	2,5
18	30	0	-5	0	-5	5	4	2,5	4	4	5		2,5
30	50	0	-6	0	-6	6	5	3	5	4	5		2,5
50	80	0	-7	0	-7	7	5	3,5	5	4	5		3
80	120	0	-8	0	-8	8	6	4	6	5	6		4
120	150	0	-9	0	-9	9	7	5	7	5	7		5
150	180	0	-10	0	-10	10	8	5	8	5	8		5
180	250	0	-11	0	-11	11	8	6	10	7	10		7
250	315	0	-13	0	-13	13	10	7	11	8	10		7
315	400	0	-15	0	-15	15	11	8	13	10	13		8

1) Valid only for bearings with diameter series 0, 1, 2, 3 and 4

2) Valid only for ball bearings

3) Not valid for shielded or sealed bearings

Outer Ring							Tab. 14b	
D		Δ_{Dmp}		V_{Dp}	K_{ea}	S_D	Δ_{Cs}	V_{Cs}
over	incl.	max	min	max	max	max		
mm		μm						
50	80	0	-9	5	5	8	Corresponds to Δ_{Bs} a V_{Bs} of the same bearing inner ring	
80	120	0	-10	5	6	9		
120	150	0	-11	6	7	10		
150	180	0	-13	7	8	10		
180	250	0	-15	8	10	11		
250	315	0	-18	9	11	13		
315	400	0	-20	10	13	13		
400	500	0	-23	12	15	15		
500	630	0	-28	14	17	18		
630	800	0	-35	18	20	20		

Dimension and Running Accuracy of Cylindrical Roller Bearings with Tapered Bore											Tab. 15a
Tolerance Class UP											
Inner Ring											
d		Δ_{dmp}		$\Delta_{d1mp} - \Delta_{dmp}$		V_{dp}	K_{ia}	S_d	Δ_{Bs}		V_{Bs}
over	incl.	max	min	max	min	max	max	max	max	min	max
mm		μm									
18	30	+ 6	0	+ 2	0	3	1,5	3	0	-25	1,5
30	50	+ 7	0	+3	0	3	2	3	0	-30	2
50	80	+ 8	0	+3	0	4	2	4	0	-40	3
80	120	+ 10	0	+4	0	4	3	4	0	-50	3
120	180	+ 12	0	+ 5	0	5	3	5	0	-60	4
180	250	+ 14	0	+ 6	0	6	4	6	0	-75	5
250	315	+ 17	0	+ 8	0	8	5	6	0	-90	6

Dimension and Running Accuracy of Tapered Roller Bearings														Tab. 16a
Tolerance Class P0														
Cone and Overall Bearing Width														
d		Δ_{dmp}		V_{dp}	V_{dmp}	K_{ia}	Δ_{Bs}		Δ_{Ts}		Δ_{T1s}		Δ_{T2s}	
over	incl.	max	min	max	max	max	max	min	max	min	max	min	max	min
mm		μm												
10	18	0	-12	12	9	15	0	-120	+ 200	0	+ 100	0	+ 100	0
18	30	0	-12	12	9	18	0	-120	+ 200	0	+ 100	0	+ 100	0
30	50	0	-12	12	9	20	0	-120	+ 200	0	+ 100	0	+ 100	0
50	80	0	-15	15	11	25	0	-150	+ 200	0	+ 100	0	+ 100	0
80	120	0	-20	20	15	30	0	-200	+ 200	-200	+ 100	-100	+ 100	-100
120	180	0	-25	25	19	35	0	-250	+350	-250	+ 150	-150	+ 200	-100
180	250	0	-30	30	23	50	0	-300	+350	-250	+ 150	-150	+ 200	-100

Dimension and Running Accuracy of Tapered Roller Bearings														Tab. 17a
Tolerance Class P6X														
Cone and Overall Bearing Width														
d		Δ_{dmp}		V_{dp}	V_{dmp}	K_{ia}	Δ_{Bs}		Δ_{Ts}		Δ_{T1s}		Δ_{T2s}	
over	incl.	max	min	max	max	max	max	min	max	min	max	min	max	min
mm		μm												
10	18	0	-12	12	9	15	0	-50	+ 100	0	+ 50	0	+ 50	0
18	30	0	-12	12	9	18	0	-50	+ 100	0	+ 50	0	+ 50	0
30	50	0	-12	12	9	20	0	-50	+ 100	0	+ 50	0	+ 50	0
50	80	0	-15	15	11	25	0	-50	+ 100	0	+ 50	0	+ 50	0
80	120	0	-20	20	15	30	0	-50	+ 100	0	+ 50	0	+ 50	0
120	180	0	-25	25	19	35	0	-50	+ 150	0	+ 50	0	+ 100	0

Outer Ring							Tab. 15b
D		Δ_{Dmp}		V_{Dp}	K_{ea}	S_D	Δ_{Cs} V_{Cs}
over	incl.	max	min	max	max	max	
mm		μm					
50	80	0	-6	3	3	2	Corresponds to Δ_{Bs} a V_{Bs} of the same bearing cone
80	120	0	-7	4	3	3	
120	150	0	-8	4	4	3	
150	180	0	-9	5	4	3	
180	250	0	-10	5	5	4	
250	315	0	-12	6	6	4	
315	400	0	-14	7	7	5	

Cup								Tab. 16b
D		Δ_{Dmp}		V_{Dp}	V_{Dmp}	K_{ea}	Δ_{Cs}	
over	incl.	max	min	max	max	max	max	min
mm		μm						
18	30	0	-12	12	9	18	0	-120
30	50	0	-14	14	11	20	0	-120
50	80	0	-16	16	12	25	0	-150
80	120	0	-18	18	14	35	0	-200
120	150	0	-20	20	15	40	0	-250
150	180	0	-25	25	19	45	0	-250
180	250	0	-30	30	23	50	0	-300
250	315	0	-35	35	26	60	0	-350
315	400	0	-40	40	30	70	0	-400

Cup								Tab. 17b
D		Δ_{Dmp}		V_{Dp}	V_{Dmp}	K_{ea}	Δ_{Cs}	
over	incl.	max	min	max	max	max	max	min
mm		μm						
18	30	0	-12	12	9	18	0	-100
30	50	0	-14	14	11	20	0	-100
50	80	0	-16	16	12	25	0	-100
80	120	0	-18	18	14	35	0	-100
120	150	0	-20	20	15	40	0	-100
150	180	0	-25	25	19	45	0	-100
180	250	0	-30	30	23	50	0	-100
250	315	0	-35	35	26	60	0	-100

Dimension and Running Accuracy of Tapered Roller Bearings								Tab. 18a	
Tolerance Class P6									
Cone and Overall Bearing Width									
d		Δ_{dmp}		K_{ia}	Δ_{Bs}		Δ_{Ts}		
over	incl.	max	min	max	max	min	max	min	
mm		μm							
10	18	0	-7	7	0	-200	+200	0	
18	30	0	-8	8	0	-200	+200	0	
30	50	0	-10	10	0	-240	+200	0	
50	80	0	-12	10	0	-300	+200	0	
80	120	0	-15	13	0	-400	+200	-200	
120	180	0	-18	18	0	-500	+350	-250	

Dimension and Running Accuracy of Tapered Roller Bearings											Tab. 19a	
Tolerance Class P5												
Cone and Overall Bearing Width												
d		Δ_{dmp}		V_{dp}	V_{dmp}	K_{ia}	S_d	Δ_{Bs}		Δ_{Ts}		
over	incl.	max	min	max	max	max	max	max	min	max	min	
mm		μm										
10	18	0	-7	5	5	5	7	0	-200	+200	-200	
18	30	0	-8	6	5	5	8	0	-200	+200	-200	
30	50	0	-10	8	5	5	8	0	-240	+200	-200	
50	80	0	-12	9	6	7	8	0	-300	+200	-200	
80	120	0	-15	11	8	8	9	0	-400	+200	-200	
120	180	0	-18	14	9	11	10	0	-500	+350	-250	

Dimension and Running Accuracy of Thrust Bearings									Tab. 20a	
Tolerance Class P0, P6 and P5										
Shaft Washer										
d		Δ_{dmp} Δ_{dzmp}		V_{dp} V_{dzp}	$S_f^{1)}$					
over	incl.	max	min	max	P0	P6	P5			
mm		μm								
-	18	0	-8	6	10	5	3			
18	30	0	-10	8	10	5	3			
30	50	0	-12	9	10	6	3			
50	80	0	-15	11	10	7	4			
80	120	0	-20	15	15	8	4			
120	180	0	-25	19	15	9	5			
180	250	0	-30	23	20	10	5			
250	315	0	-35	26	25	13	7			
315	400	0	-40	30	30	15	7			
400	500	0	-45	34	30	18	9			
500	630	0	-50	38	35	21	11			
630	800	0	-75	-	40	25	13			
800	1000	0	-100	-	45	30	15			

Cup					Tab. 18b
D		Δ_{Dmp}		K_{ea}	Δ_{Cs}
over	incl.	max	min	max	
mm		μm			
18	30	0	-8	9	Corresponds to Δ_{Bs} of the same bearing cone
30	50	0	-9	10	
50	80	0	-11	13	
80	120	0	-13	18	
120	150	0	-15	20	
150	180	0	-18	23	
180	250	0	-20	25	
250	315	0	-25	30	

Cup								Tab. 19b
D		Δ_{Dmp}		V_{Dp}	V_D	K_{ea}	S_D	Δ_{Cs}
over	incl.	max	min	max	max	max	max	
mm		μm						
18	30	0	-8	6	5	6	8	Corresponds to Δ_{Bs} of the same bearing cone
30	50	0	-9	7	5	7	8	
50	80	0	-11	8	6	8	8	
80	120	0	-13	10	7	10	9	
120	150	0	-15	11	8	11	10	
150	180	0	-18	14	9	13	10	
180	250	0	-20	15	10	15	11	
250	315	0	-25	19	13	18	13	

Housing Washer					Tab. 20b
D		Δ_{Dmp}		V_{Dp}	$S_e^{1)}$
over	incl.	max	min	max	
mm		μm			
18	30	0	-13	10	Corresponds to S_i of shaft washer of the same bearing
30	50	0	-16	12	
50	80	0	-19	14	
80	120	0	-22	17	
120	180	0	-25	19	
180	250	0	-30	23	
250	315	0	-35	26	
315	400	0	-40	30	
400	500	0	-45	34	
500	630	0	-50	38	
630	800	0	-75	55	
800	1000	0	-100	75	
1000	1250	0	-125	-	
1250	1600	0	-160	-	

1) Not valid for thrust spherical roller bearings

2.4 Internal Clearance

Bearing clearance is the value of one bearing displacement length of assembled bearing with respect to the other ring from one end position to the other one. The displacement can be in radial direction (radial clearance) or axial (axial clearance). In a mounted bearing smaller radial clearance can be found than the same bearing had before mounting.

Radial clearance reduction is caused by interference of the bearing rings on the shaft and in housing bore and thus it is dependent on selected tolerance of bearing seating surface diameters. Another change of radial clearance, mainly its reduction, arises during operation from temperatures evoked by its own operation and surrounding sources, but also by elastic deformations caused by load.

Clearance for standard designed bearings is determined so that one of the bearing rings can be fixed, what is sufficient for most operation conditions in the arrangement. For special arrangements with different requirement on the radial clearance bearings with various radial clearance designated C1 up to C5 are produced. Values for various internal clearances according to the standard ISO 5753 are shown for individual bearing types in tables 21 up to 27 and these values are valid for non-mounted bearings by zero measuring load.

For double row angular contact ball bearings instead of radial clearance the axial clearance measured at axial load 100 N is introduced. Single row angular contact ball bearings and single row tapered roller bearings are usually mounted in pairs and the radial or axial clearance is adjusted during mounting.

Radial Clearance of Single Row Ball Bearings													Tab. 21		
Bore Diameter		Radial Clearance										Single Row Separable Ball Bearings Type E and BO		Radial Clearance	
d		C2		normal		C3		C4		C5				min	max
over	to	min	max	min	max	min	max	min	max	min	max				
mm		µm										µm			
2,5	10	0	7	2	13	8	23	14	29	20	37	E10, E12		15	30
10	18	0	9	3	18	11	25	18	33	25	45	E15		15	30
18	24	0	10	5	20	13	28	20	36	28	48	B017, E17		25	45
24	30	1	11	5	20	13	28	23	41	30	53	E20		20	40
30	40	1	11	6	20	15	33	28	46	40	64				
40	50	1	11	6	23	18	36	30	51	45	73				
50	65	1	15	8	28	23	43	38	61	55	90				
65	80	1	15	10	30	25	51	46	71	65	105				
80	100	1	18	12	36	30	58	53	84	75	120				
100	120	2	20	15	41	36	66	61	97	90	140				
120	140	2	23	18	48	41	81	71	114	105	160				
140	160	2	23	18	53	46	91	81	130	120	180				
160	180	2	25	20	61	53	102	91	147	135	200				
180	200	2	30	25	71	63	117	107	163	150	215				
200	225	4	32	28	82	73	132	120	187	175	255				
225	250	4	36	31	92	87	152	140	217	205	290				
250	280	4	39	36	97	97	162	152	237	225	320				
280	315	8	45	42	110	110	180	175	260	260	360				
315	355	8	50	50	120	120	200	200	290	290	405				
355	400	8	60	60	140	140	230	230	330	330	460				

Axial Clearance of Double Row Angular Contact Ball Bearings								Tab. 22	
Bore Diameter		Axial Clearance							
d		C2		normal		C3		C4	
over	to	min	max	min	max	min	max	min	max
mm		µm							
6	10	1	11	5	21	12	28	25	45
10	18	1	12	6	23	13	31	27	47
18	24	2	14	7	25	16	34	28	48
24	30	2	15	8	27	18	37	30	50
30	40	2	16	9	29	21	40	33	54
40	50	2	19	11	33	23	44	36	58
50	65	3	22	13	36	26	48	40	63
65	80	3	24	15	40	30	54	46	71

Radial Clearance of Double Row Self-Aligning Ball Bearings																		Tab. 23			
Bore Diameter		Cylindrical Bore										Tapered Bore									
		Radial Clearance										Radial Clearance									
d		C2		normal		C3		C4		C5		C2		normal		C3		C4		C5	
over	to	min	max	min	max	min	max	min	max	min	max	min	max	min	max	min	max	min	max	min	max
mm		µm										µm									
2,5	6	1	8	5	15	10	20	15	25	21	33	-	-	-	-	-	-	-	-	-	-
6	10	2	9	6	17	12	25	19	33	27	42	-	-	-	-	-	-	-	-	-	-
10	14	2	10	6	19	13	26	21	35	30	48	-	-	-	-	-	-	-	-	-	-
14	18	3	12	8	21	15	28	23	37	32	50	-	-	-	-	-	-	-	-	-	-
18	24	4	14	10	23	18	30	25	39	34	52	7	17	13	26	20	33	28	42	37	55
24	30	5	16	11	24	19	35	29	46	40	58	9	20	15	28	23	39	33	50	44	62
30	40	6	18	13	29	23	40	34	53	46	66	12	24	19	35	29	46	40	59	52	72
40	50	6	19	14	31	25	44	37	57	50	71	14	27	22	39	33	52	45	65	58	79
50	65	7	21	16	36	30	50	45	69	62	88	18	32	27	47	41	61	56	80	73	99
65	80	8	24	18	40	35	60	54	83	76	108	23	39	35	57	50	75	69	98	91	123
80	100	9	27	22	48	42	70	64	96	89	124	29	47	42	68	62	90	84	116	109	144
100	120	10	31	25	56	50	83	75	114	105	145	35	56	50	81	75	108	100	139	130	170
120	140	10	38	30	68	60	100	90	135	125	175	-	-	-	-	-	-	-	-	-	-
140	160	15	44	35	80	70	120	110	161	150	210	-	-	-	-	-	-	-	-	-	-

Radial Clearance of Single Row Cylindrical Roller Bearings										Tab. 24	
Bore Diameter		Radial Clearance									
d		C2		normal		C3		C4		C5	
over	incl.	min	max	min	max	min	max	min	max	min	max
mm		µm									
10	24	0	25	20	45	35	60	50	75	65	90
24	30	0	25	20	45	35	60	50	75	70	95
30	40	5	30	25	50	45	70	60	85	80	105
40	50	5	35	30	60	50	80	70	100	95	125
50	65	10	40	40	70	60	90	80	110	110	140
65	80	10	45	40	75	65	100	90	125	130	165
80	100	15	50	50	85	75	110	105	140	155	190
100	120	15	55	50	90	85	125	125	165	180	220
120	140	15	60	60	105	100	145	145	190	200	245
140	160	20	70	70	120	115	165	165	215	225	275
160	180	25	75	75	125	120	170	170	220	250	300
180	200	35	90	90	145	140	195	195	250	275	330
200	225	45	105	105	165	160	220	220	280	305	365
225	250	45	110	110	175	170	235	235	300	330	395
250	280	55	125	125	195	190	260	260	330	370	440
280	315	55	130	130	205	200	275	275	350	410	485
315	355	65	145	145	225	225	305	305	385	455	535
355	400	100	190	190	280	280	370	370	460	510	600
400	450	110	210	210	310	310	410	410	510	565	665
450	500	110	220	220	330	330	440	440	550	625	735
500	560	120	240	240	360	360	480	480	600	695	815
560	630	140	260	260	380	380	500	500	620	780	900
630	710	145	285	285	425	425	565	565	705	870	1010
710	800	150	310	310	470	470	630	630	790	980	1140
800	900	180	350	350	520	520	690	690	860	1100	1270
900	1000	200	390	390	580	580	770	770	960	1220	1410
1000	1120	220	430	430	640	640	850	850	1060	1360	1570
1120	1250	230	470	470	710	710	950	950	1190	1520	1760

Radial Clearance of Double Row Cylindrical Roller Bearings with Tapered Bore										Tab. 25	
Bearing with Non-Interchangeable Rings Determined for Machine Tool Spindles											
Bore Diameter		Radial Clearance				Bore Diameter		Radial Clearance			
d		C1NA		C2NA		d		C1NA		C2NA	
over	incl.	min	max	min	max	nad	do	min	max	min	max
mm		µm				mm		µm			
24	30	15	25	25	35	160	180	55	85	75	110
30	40	15	25	25	40	180	200	60	90	80	120
40	50	17	30	30	45	200	225	60	95	90	135
50	65	20	35	35	50	225	250	65	100	100	150
65	80	25	40	40	60	250	280	75	110	110	165
80	100	35	55	45	70	280	315	80	120	120	180
100	120	40	60	50	80	315	355	90	135	135	200
120	140	45	70	60	90	355	400	100	150	150	225
140	160	50	75	65	100	400	450	110	170	170	255

Radial Clearance of Single Row Needle Roller Bearings with Interchangeable Rings						Tab. 26
Bore Diameter		Radial Clearance				
d		normal		C3		
over	incl.	min	max	min	max	
mm		µm				
10	14	10	50	25	70	
14	18	15	55	35	75	
18	24	25	65	40	80	
24	30	30	65	50	80	
30	40	40	75	60	95	
40	50	40	85	65	100	
50	65	45	90	70	120	
65	80	50	110	75	135	
80	100	60	115	95	150	
100	120	70	125	115	70	
120	140	80	155	130	205	
140	160	80	160	140	210	

Radial Clearance of Double Row Spherical Roller Bearings											Tab. 27
Bore Diameter		Cylindrical Bore									
		Radial Clearance									
		C2		normal		C3		C4		C5	
over	incl.	min	max	min	max	min	max	min	max	min	max
mm		µm									
30	40	15	30	35	45	45	60	60	80	80	100
40	50	20	35	35	55	55	75	75	100	100	125
50	65	20	40	40	65	65	90	90	120	120	150
65	80	30	50	50	80	80	110	110	145	145	180
80	100	35	60	60	100	100	135	135	180	180	225
100	120	40	75	75	120	120	160	160	210	210	260
120	140	50	95	95	145	145	190	190	240	240	300
140	160	60	110	110	170	170	220	220	280	280	350
160	180	65	120	120	180	180	240	240	310	310	390
180	200	70	130	130	200	200	260	260	340	340	430
200	225	80	140	140	220	220	290	290	380	380	470
225	250	90	150	150	240	240	320	320	420	420	520
250	280	100	170	170	260	260	350	350	460	460	570
280	315	110	190	190	280	280	370	370	500	500	630
315	355	120	200	200	310	310	410	410	550	550	690
355	400	130	220	220	340	340	450	450	600	600	760
400	450	140	240	240	370	370	500	500	660	660	820
450	500	140	260	260	410	410	550	550	720	720	900
500	560	150	280	280	440	440	600	600	780	780	1000
560	630	170	310	310	480	480	650	650	850	850	1100
630	710	190	350	350	530	530	700	700	920	920	1190
710	800	210	390	390	580	580	770	770	1010	1010	1300
800	900	230	430	430	650	650	860	860	1120	1120	1440

Bore Diameter		Tapered Bore									Tab. 27b
d		Radial Clearance									
		C2		normálna		C3		C4		C5	
over	incl.	min	max	min	max	min	max	min	max	min	max
mm		µm									
30	40	25	35	35	50	50	65	65	85	85	105
40	50	30	45	45	60	60	80	80	100	100	130
50	65	40	55	55	75	75	95	95	120	120	160
65	80	50	70	70	95	95	120	120	150	150	200
80	100	55	80	80	110	110	140	140	180	180	230
100	120	65	100	100	135	135	170	170	220	220	280
120	140	80	120	120	160	160	200	200	260	260	330
140	160	90	130	130	180	180	230	230	300	300	380
160	180	100	140	140	200	200	260	260	340	340	430
180	200	110	160	160	220	220	290	290	370	370	470
200	225*	120	180	180	250	250	320	320	410	410	520
225	250	140	200	200	270	270	350	350	450	450	570
250	280	150	220	220	300	300	390	390	490	490	620
280	315	170	240	240	330	330	430	430	540	540	680
315	355	190	270	270	360	360	470	470	590	590	740
355	400	210	300	300	400	400	520	520	650	650	820
400	450	230	330	330	440	440	570	570	720	720	910
450	500	260	370	370	490	490	630	630	790	790	1000
500	560	290	410	410	540	540	680	680	870	870	1100
560	630	320	460	460	600	600	760	760	980	980	1230
630	710	350	510	510	670	670	850	850	1090	1090	1360
710	800	390	570	570	750	750	960	960	1220	1220	1500
800	900	440	640	640	840	840	1070	1070	1370	1370	1690

2.5 CAGES

Cage in the rolling bearing fulfills the following roles :

- separates rolling elements evenly around the periphery
- prevents contact of rolling elements and their sliding
- prevents falling out of the rolling elements from separable or self-aligning bearings when mounting.

From the point of view of design and material the cages are divided into pressed and machined. Pressed cages are made of steel or brass sheet and are mostly used in dimensionally smaller and medium bearings. Their advantage in comparison with the solid cages is the smaller weight. Machined cages are made of steel, brass, bronze, light metals or plastic in various designs. Cages made of metals are used when there are higher demands on the cage rigidity and the bearing is determined for higher operational temperatures. Cages are radially centered on the rolling elements in bearings, this is the most usual way, or they are centered on the rib of either of the bearing rings. Bearings without cages, i.e. with full complement of rolling elements, are only rarely used, namely only for some bearing types, e.g. single row needle roller bearings. In the texts about individual bearing types the survey of cages in standard design and delivery possibilities of bearings with cages of non-standard design are given in the section Cages.

2.6 SHIELDS AND SEALS

Bearings with sealing on one or both sides are manufactured with shields (Z, 2Z, ZR, 2ZR) or seals (RS, 2RS, RSR, 2RSR).

Shields form a non-contact sealing. In design Z and 2Z the fitting for the shield is in the inner ring, in design ZR and 2ZR the shield adheres on the smooth rib of the bearing inner ring.

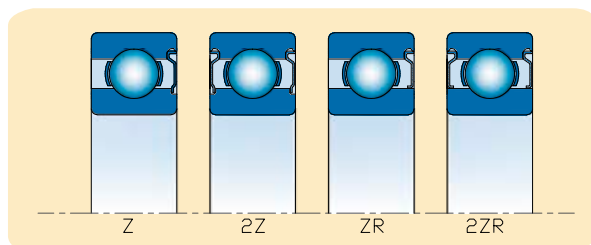

Sealing is created by sealing rings made of rubber vulcanized on sheet steel reinforcement, which create an effective contact sealing with a chamfered fitting on the inner ring (RS, 2RS) as well as in design with contact on the smooth rib of the inner ring (RSR, 2RSR). Seals and sealing rings are fastened in the grooves of the outer ring and are unseparable. Sealing RS, 2RS, RSR, 2RSR can be used for temperature range -30°C to +110°C, sealing RS1, -2RS1, RSR1 and -2RSR1 for temperature range -45°C to +120°C, sealing RS2, -2RS2, RSR2, -RSR2 for temperature range -60°C to +150°C.

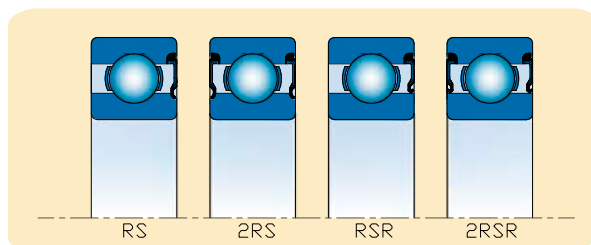

Bearings with sealings on both sides in standard design are filled with grease of a temperature range from -30°C to 110°C, whose qualities secure lubrication usually during the whole bearing life at normal operational conditions. Bearings in this design cannot be relubricated.

3. BEARING ARRANGEMENT DESIGN

3.1 GENERAL PRINCIPLES OF ROLLING BEARING ARRANGEMENT DESIGN

Rotating shaft or another component arranged in rolling bearings is guided by them in radial as well as in axial direction so that the basic condition, the movement uniqueness, can be fulfilled. The component should be, as far as possible, statically determined, i.e. supported in two points radially and in one point axially.

A typical example of such an arrangement is in Pict. 9, where the shaft is radially guided in two bearings, one of which secures it in axial direction. The locating bearing carries the radial load and simultaneously also the axial load in both directions. Radial bearings that can accommodate combined load are mostly used as locating bearings, which carry, e.g. single row ball bearings, double row angular contact ball bearings, double row self-aligning ball bearings, double row spherical roller bearings or single row angular contact ball bearings and tapered roller bearings. The two last mentioned bearing types must be mounted in pairs. The non-locating bearing carries only radial load and must permit certain displacement of the shaft in axial direction so that arising of non-desired axial preload caused by environment (temperature dilatations, production inaccuracies of connecting arrangement components, etc.) can be hindered. Axial displacement can be secured by displacement between one bearing ring and a machine part, which is directly connected with the bearing, e.g. between outer bearing ring and housing bore (see Figure 9a) or directly in the bearing (see Figure 9b).

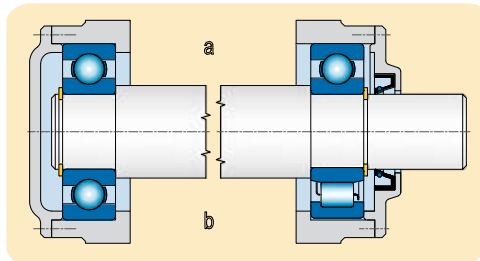

Figure 9

Arrangements, in which greater radial and axial loads act by higher rotational speed, should be set up so that the bearing can accommodate only radial or axial forces, see Pict. 10. In these cases it is possible to use for radial guidance some of the radial bearings and for axial guidance those radial bearings which are also able to carry axial load or a pair of these bearings, or double direction thrust bearing, or a pair of single direction thrust bearings. There is a condition where the axially locating thrust bearing should be arranged with radial clearance. Another, often used solution is the arrangement of two bearings, whose design enables the accommodation both radial and axial loads. Both bearings accommodate alternately the axial load, always according to direction of force acting, and simultaneously they carry also the radial load. An example of this arrangement is shown in Figure 11. As a verified design the pair of single row tapered roller bearings or single row angular contact ball bearings are used. There can be used other bearing types which are able to carry the load both in radial and axial direction simultaneously, e.g. separable single row ball bearings or single row cylindrical roller bearings in NJ design, etc.

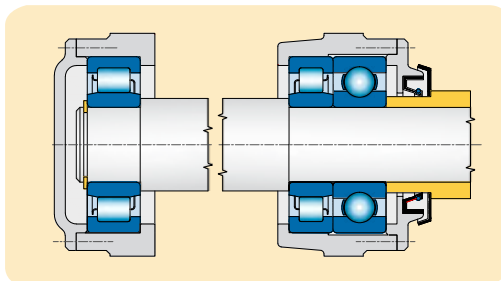

Figure 10

3.2 BEARING LOCATION

Radial and axial bearing location on the shaft and in the housing bore or another part has a direct connection with the whole arrangement design. When selecting the way of location, the character and acting forces magnitude, the operating temperature in the arrangement and material of mating parts must be taken into account. Mounting, dismounting and maintenance methods must be taken into consideration when designing mating parts dimensions.

3.2.1 Radial Location of Bearing

The bearing is located in radial direction on the mating cylindrical shaft and housing bore surface. In some cases, adapter or withdrawal sleeves are used by mounting on the shaft, or the bearing can be mounted directly on the tapered shaft.

The correct radial location of the bearing on the shaft significantly influences utilization of its load rating and correct function in arrangement. The following viewpoints are important :

- safe location and uniform supporting of bearings
- simple mounting and dismounting
- displacement of non-locating bearing in axial direction

Basically, both bearing rings should be mounted in tight fits, because only in this way their reliable supporting around the whole periphery and radial fixing against turning can be achieved. To make mounting and dismounting easier or for moving the non-locating ring, a loose fit of one of the rings is permissible.

When selecting correct radial bearing location, following influences must be taken into account.

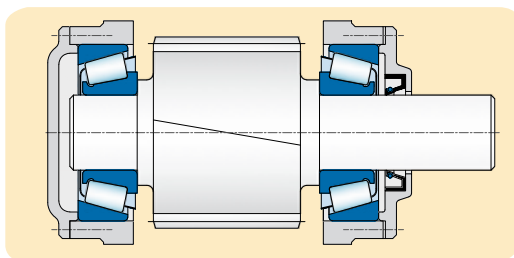

Figure 11

Circumferential Load

- occurs if the respective bearing ring rotates and the load direction is not changed or if the ring rotates and the load does not rotate. The bearing ring periphery is gradually loaded during one revolution. In this case the loaded bearing ring must be always fitted with necessary interference fit.

Point Load

- occurs when the bearing ring does not rotate and the external force is constantly directed into the same ring raceway point or if the ring and load rotate at the same rotating speed. The ring subjected to point load can be mounted with loose fit, if the conditions require it.

Indeterminate Load

- occurs if the ring is subjected to varying external forces at which directions and load changes cannot be determined (e.g. unbalanced mass, shocks, etc.). Under these conditions in most applications bearings with greater radial clearance should be used.

Load Magnitude

- directly influences selection of the interference fit (higher load - larger interference), especially in cases of impact loads. A firm fitting on the shaft or in the housing causes ring deformation, and as a result reduction of radial clearance arises. To secure the necessary radial clearance in the firm arrangement, it is necessary

to use bearings with greater radial clearance. Resulting clearance after mounting depends on the bearing type and its dimension.

Bearing Size and Type

- determines the size of necessary interference fit of the fitted ring. For smaller sized bearings smaller interference fits are selected, and vice versa. Relatively smaller interferences are used, e.g. for the same sizes of ball bearings in comparison with the cylindrical roller, tapered roller or spherical roller bearings.

Material and Design of Mating Components must be taken into account when determining their production tolerance. Results of practical experience are shown in the following tables. In cases where bearings are mounted into housings made of light metal alloys or on journals of hollow shafts, arrangements with higher interference are selected.

Split housings are not suitable for arrangements with higher interferences, because there is danger of the bearing pinching in the dividing plane.

Heating generating in the bearing can cause loosening of the interference on the journal and turning of the ring. In the housing a converse case can come into being. The heating causes clearance decreasing and subsequently limiting and even stopping of the axial displacement of the non-locating bearing ring. That is why we pay a great deal of attention to this fact when designing an arrangement.

Fitting Accuracy from the point of view of its tolerances and geometric shapes is important because it can be transmitted towards the bearing ring raceways and defines the arrangement accuracy. When using bearings with normal tolerance class, the tolerance of journal seating surface IT6 is selected, and for housing seating surface tolerance IT7. For smaller dimensioned ball and cylindrical roller bearings it is possible to use for the journal tolerance IT5 and housing bore IT6. For bearings in higher tolerance classes, for arrangements with high requirements on accuracy, e.g. spindels of machine tools, the least tolerance class IT5 is recommended for the shaft and for housing IT6. Permissible ovality and conicity deviation and permissible lateral bearing runout of supporting surfaces must be in reference to axis smaller than the diameter tolerance of the journal and bore. With higher bearing tolerance class also requirements on the seating surface accuracy increase. Recommended values are shown in tables 28 and 29.

Mounting and Dismounting of bearings, if one of the rings is arranged with a loose fit it is simple. If, because of operational reasons, it is necessary to arrange both of the rings with an interference, a suitable bearing type should be selected, e.g. a separable bearing (tapered roller, cylindrical roller, needle roller bearing) or a bearing with tapered bore. Journals for sleeve arrangements of bearings with tapered bore can be in tolerance class h9 or h10, geometric shape should be in tolerance class IT5 or IT7 according to arrangement requirements.

Axial Displacement of Non-Locating Bearing Rings must be secured by all operation conditions. When using a non-separable bearing, displacement of the stationary loaded ring is reached by its fitting with clearance (moveable). In light metal alloy housings it is necessary, if the outer ring is fitted with clearance, to put a steel bush in the bore.

A reliable displacibility in axial direction is reached by using cylindrical roller bearing type N and NU or radial needle bearing. Recommended journal and bore diameter tolerances of the mating components for radial and thrust bearings are shown in tables 30 to 35.

3.2.2 Axial Securing of Bearing

Inner bearing ring with cylindrical bore arranged on the journal with interference fit (fixed) is usually secured in the axial direction by means of a locknut, end-plate or snap ring, when the other face is usually supported by the shaft shoulder. Surrounding parts are used as abutment faces for inner rings, and if necessary, spacing rings are inserted between this component and bearing inner ring. Examples of axial bearing securing are shown in Figure 12.

Recommended Shape Accuracies of Bearing Seating Fits			Tab. 28
Bearing Tolerance Class	Fitting Location	Permissible Ovality Deviation	Permissible Lateral Runout of Carrying Surfaces in Reference to Axis
PO, P6	shaft	IT5/2	IT3
	housing	IT6/2	IT4
	shaft	IT3/2	IT2
P5, P4	housing	IT4/2	IT3

Standard Tolerances IT2 to IT6						Tab. 29
Nominal Diameter		Tolerance Class				IT6
over	incl.	IT2	IT3	IT4	IT5	
mm		µm				
6	10	1,5	2,5	4	6	9
10	18	2	3	5	8	11
18	30	2,5	4	6	9	13
30	50	2,5	4	7	11	16
50	80	3	5	8	13	19
80	120	4	6	10	15	22
120	180	5	8	12	18	25
180	250	7	10	14	20	29
250	315	8	12	16	23	32
315	400	9	13	18	25	36
400	500	10	15	20	27	40

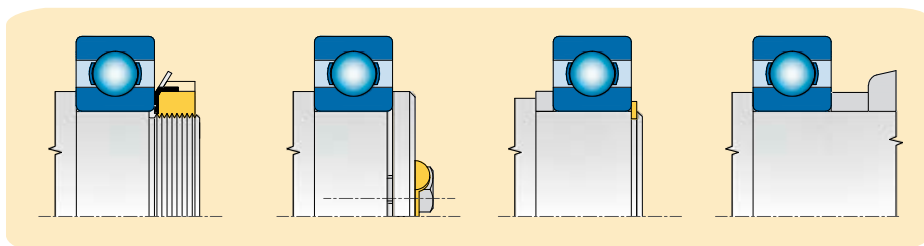

Figure 12

Radial Bearing Shaft Diameter Tolerances (Valid for Solid Steel Shafts)					Tab. 30
		Journal Diameter [mm]			
Operating Conditions	Arrangement Examples	Ball Bearings	Cylindrical, Needle ¹⁾ Tapered Roller Bearings	Spherical Roller Bearings	Tolerance
Inner Ring Point Load					
Light and Normal Load Pr ≤ 0,15 Cr	Free wheels, sheaves, belt pulleys	All Diameters			g6 ²⁾
Heavy Impact Load Pr > 0,15 Cr	Industrial truck wheels, tension pulleys	All Diameters			h6
Inner Ring Circumferential Load or Indeterminate Load					
Light and Variable Load Pr ≤ 0,07 Cr	transport equipments, ventilators	(18) to 100	≤40	-	i6
		(100) to 200	(40) to 140	-	k6
Normal and Heavy Load Pr > 0,07 Cr	General engineering, electric motors, turbines, pumps, combustion motors, gear boxes, woodworking machines	≤18	-	-	j5
		(18) to 100	≤40	≤40	k5 (k6) ³⁾
		(100) to 140	(40) to 100	(40) to 65	m5 (m6) ³⁾
		(140) to 200	(100) to 140	(65) to 100	m6
		(200) to 500	(140) to 200	(100) to 140	n6
		>500	>200	>140	p6
Extremely Heavy Load, Impacts Complicated Operating Conditions Pr > 0,15 Cr	Axle bearings for railway vehicles, traction motors, rolling mills	-	50 to 140	50 to 140	n6 ⁴⁾
		-	(140) to 500	(140) to 500	p6 ⁴⁾
		-	>500	>500	r6 (p6) ⁴⁾
High Arrangement Accuracy under Light Load Pr ≤ 0,07 Cr	Machine tools	≤18	-	-	h5 ⁵⁾
		(18) to 100	≤40	-	j5 ⁵⁾
		(100) to 200	(40) to 140	-	k5 ⁵⁾
		-	(140) to 200	-	m5
Exclusively Axial Load					
Bearings with Tapered Bore and Adapter or Withdrawal Sleeve					
All Kinds of Load	General arrangements, axle bearings for railway vehicles.	All Diameters			h9/IT5
	Not complicated arrangements				h10/IT7

1) Tolerances for needle roller bearings without rings, see page 133

2) Tolerance f6 can be selected for securing axial displacibility

3) Tolerances in brackets are selected usually for single row tapered roller bearings or at low rotational speeds where tolerance dispersion is not significant

4) It is necessary to use bearings with higher radial clearance than normal

5) Tolerances for single row ball bearings in tolerance classes P5 and P4 are shown on page 89

Housing Bore Diameter Tolerances for Radial Bearings (Valid for Steel, Cast and Cast Steel Housings)				Tab. 31
Operating Conditions	Displacibility of Outer Ring	Housing	Arrangement Examples	Tolerance
Outer Ring Circumferential Load				
Heavy Impact Load Pr > 0,15 Cr Thin Walled Housings	not dispacable	one-part	Wheel hubs with cylindrical roller bearings, big end bearings	P7
Normal and Heavy Load Pr > 0,07 Cr	not dispacable		Wheel hubs with ball bearings, crane travel wheels, crankshaft bearings	N7
Light and Variable Load Pr ≤ 0,07 Cr	not dispacable		Conveyor rollers, tension pulleys	M7
Indeterminate Load				
Heavy Impact Load Pr > 0,15 Cr	not dispacable	one-part	Traction motors	M7
Heavy and Normal Load Pr > 0,07 Cr	As a rule, not dispacable		Electric motors, pumps, crankshafts	K7
Light and Varying Load Pr ≤ 0,07 Cr	As a rule, dispacable		Electric motors, pumps, crankshafts	J7
Accurate Arrangement				
Light Load Pr ≤ 0,07 Cr	As a rule, not dispacable	one-part	Cylindrical roller bearings for machine tools ball bearings for machine tools. Small electric motors	K6 1)
	Dispacable			J6 2)
	Easily dispacable			H6
Outer Ring Point Load				
Any Load	Easily dispacable	One-part or two-part	General engineering, axle bearings of railway vehicles	H7 3)
Light and Normal Load Pr ≤ 0,15 Cr	Easily dispacable	One-part or two-part	General engineering, less complicated engineering	H8
			Drying rollers of paperworking machines, big electric motors	G7 4)

- 1) For heavy loads tighter tolerances are selected - M6 or N6. For cylindrical roller bearings with tapered bore tolerances K5 or M5
2) Tolerances for single row ball bearings in tolerances P5 and P4 - see page 89.
3) For bearings with outer diameter D < 250 mm, with temperature difference between outer ring and housing over 10°C, tolerance G7 is selected
4) For bearings with outer diameter D > 250 mm, with temperature difference between outer ring and housing over 10°C, tolerance F7 is selected

Journal Diameter Tolerance for Thrust Bearings				Tab. 32
Bearing Type	Load		Journal Diameter [mm]	Tolerance
Thrust Ball Bearings	Exclusively Axial Load		All Diameters	j6
Thrust Spherical Roller Bearings	Simultaneously Axial	Stationary Load of Shaft Washer or Indeterminate Load	All Diameters	j6
	and Radial Loads	Rotating Load	≤ 200	k6
		of Shaft	(200) to 400	m6
		Washer	> 400	n6

Housing Bore Diameter Tolerances for Thrust Bearings				Tab. 33
Bearing Type	Load		Note	Tolerance
Thrust Ball Bearings	Exclusively Axial Load		In common arrangement housing washer can have clearance	H8
			Housing washer mounted with radial clearance	-
Thrust Spherical Roller Bearings	Simultaneously Axial and Radial Load	Stationary Load or Indeterminate Load of Housing Washer		H7
		Rotating Load of Housing Washer		M7

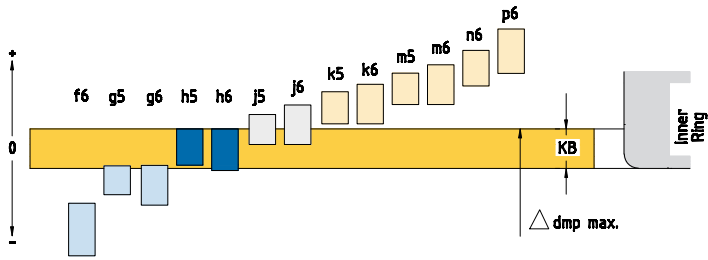

Journal Diameter Tolerance Limiting Deviations															Tab. 34a		
Journal Nominal Diameter		f6		g5		g6		h5		h6		j5		j6(js6)		k5	
over	incl.	upper	lower	upper	lower	upper	lower	upper	lower	upper	lower	upper	lower	upper	lower	upper	lower
mm		μm															
1	3	-6	-12	-2	-6	-2	-8	0	-4	0	-6	+2	-2	+4	-2	+4	0
3	6	-10	-18	-4	-9	-4	-12	0	-5	0	-8	+3	-2	+6	-2	+6	+1
6	10	-13	-22	-5	-11	-5	-14	0	-6	0	-9	+4	-2	+7	-2	+7	+1
10	18	-16	-27	-6	-14	-6	-17	0	-8	0	-11	+5	-3	+8	-3	+9	+1
18	30	-20	-33	-7	-16	-7	-20	0	-9	0	-13	+5	-4	+9	-4	+11	+2
30	50	-25	-41	-9	-20	-9	-25	0	-11	0	-16	+6	-5	+11	-5	+13	+2
50	80	-30	-49	-10	-23	-10	-29	0	-13	0	-19	+6	-7	+12	-7	+15	+2
80	120	-36	-58	-12	-27	-12	-34	0	-15	0	-22	+6	-9	+13	-9	+18	+3
120	180	-43	-68	-14	-32	-14	-39	0	-18	0	-25	+7	-11	+14	-11	+21	+3
180	250	-50	-79	-15	-35	-15	-44	0	-20	0	-29	+7	-13	+16	-13	+24	+4
250	315	-56	-88	-17	-40	-17	-49	0	-23	0	-32	+7	-16	+16	-16	+27	+4
315	400	-62	-98	-18	-43	-18	-54	0	-25	0	-36	+7	-18	+18	-18	+29	+4
400	500	-68	-108	-20	-47	-20	-60	0	-27	0	-40	+7	-20	+20	-20	+32	+5
500	630	-76	-120	-	-	-22	-66	-	-	0	-44	-	-	+22	-22	-	-
630	800	-80	-130	-	-	-24	-74	-	-	0	-50	-	-	+25	-25	-	-
800	1000	-86	-142	-	-	-26	-82	-	-	0	-56	-	-	+28	-28	-	-
1000	1250	-98	-164	-	-	-28	-94	-	-	0	-66	-	-	+33	-33	-	-

Journal Diameter Tolerance Limiting Deviations															Tab. 34b		
Journal Nominal Diameter		k6		m5		m6		n6		p6		h9 ¹⁾		h10 ¹⁾		IT5	IT7
over	incl.	upper	lower	upper	lower	upper	lower	upper	lower	upper	lower	upper	lower	lower	upper		
mm		μm															
1	3	+6	0	+6	+2	+8	+2	+10	+4	+12	+6	0	-25	0	-40	4	10
3	6	+9	+1	+9	+4	+12	+4	+16	+8	+20	+12	0	-30	0	-48	5	12
6	10	+10	+1	+12	+6	+15	+6	+19	+10	+24	+15	0	-36	0	-58	6	15
10	18	+12	+1	+15	+7	+18	+7	+23	+12	+29	+18	0	-43	0	-70	8	18
18	30	+15	+2	+17	+8	+21	+8	+28	+15	+35	+22	0	-52	0	-84	9	21
30	50	+18	+2	+20	+9	+25	+9	+33	+17	+42	+26	0	-62	0	-100	11	25
50	80	+21	+2	+24	+11	+30	+11	+39	+20	+51	+32	0	-74	0	-120	13	30
80	120	+25	+3	+28	+13	+35	+13	+45	+23	+59	+37	0	-87	0	-140	15	35
120	180	+28	+3	+33	+15	+40	+15	+52	+27	+68	+43	0	-100	0	-160	18	40
180	250	+33	+4	+37	+17	+46	+17	+60	+31	+79	+50	0	-115	0	-185	20	46
250	315	+36	+4	+43	+20	+52	+20	+66	+34	+88	+56	0	-130	0	-210	23	52
315	400	+40	+4	+46	+21	+57	+21	+73	+37	+98	+62	0	-140	0	-230	25	57
400	500	+45	+5	+50	+23	+63	+23	+80	+40	+108	+68	0	-155	0	-250	27	63
500	630	+44	0	-	-	+70	+26	+88	+44	+122	+78	0	-175	0	-280	30	70
630	800	+50	0	-	-	+80	+30	+100	+50	+138	+88	0	-200	0	-320	35	80
800	1000	+56	0	-	-	+90	+34	+112	+56	+156	+100	0	-230	0	-360	40	90
1000	1250	+66	0	-	-	+106	+40	+132	+66	+186	+120	0	-260	0	-420	46	105

1) For journals made in tolerance h9 and H10 for bearings with adapter or withdrawal sleeves deviations of roundness and cylindricity must not exceed basic tolerances IT5 and IT7

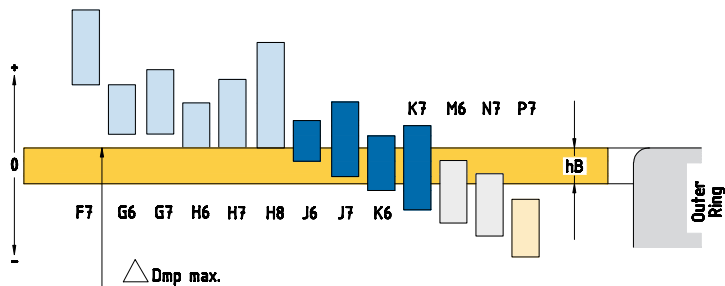

Bore Diameter Tolerance Limiting Deviations														Tab. 35a	
Bore Nominal Diameter		F7		G6		G7		H6		H7		H8		J6(Js6)	
over	incl.	upper	lower	upper	lower	upper	lower	upper	lower	upper	lower	upper	lower	upper	lower
mm		μm													
6	10	+28	+13	+14	+5	+20	+5	+9	0	+15	0	+22	0	+5	-4
10	18	+34	+16	+17	+6	+24	+6	+11	0	+18	0	+27	0	+6	-5
18	30	+41	+20	+20	+7	+28	+7	+13	0	+21	0	+33	0	+8	-5
30	50	+50	+25	+25	+9	+34	+9	+16	0	+25	0	+39	0	+10	-6
50	80	+60	+30	+29	+10	+40	+10	+19	0	+30	0	+46	0	+13	-6
80	120	+71	+36	+34	+12	+47	+12	+22	0	+35	0	+54	0	+16	-6
120	180	+83	+43	+39	+14	+54	+14	+25	0	+40	0	+63	0	+18	-7
180	250	+96	+50	+44	+15	+61	+15	+29	0	+46	0	+72	0	+22	-7
250	315	+108	+56	+49	+17	+69	+17	+32	0	+52	0	+81	0	+25	-7
315	400	+119	+62	+54	+18	+75	+18	+36	0	+57	0	+89	0	+29	-7
400	500	+131	+68	+60	+20	+83	+20	+40	0	+63	0	+97	0	+33	-7
500	630	+146	+76	+66	+22	+92	+22	+44	0	+70	0	+110	0	+22	-22
630	800	+160	+80	+74	+24	+104	+24	+50	0	+80	0	+125	0	+25	-25
800	1000	+176	+86	+82	+26	+116	+26	+56	0	+90	0	+140	0	+28	-28
1000	1250	+203	+98	+94	+28	+133	+28	+66	0	+105	0	+165	0	+33	-33
1250	1600	+235	+110	+108	+30	+155	+30	+78	0	+125	0	+195	0	+39	-39

Bore Diameter Tolerance Limiting Deviations														Tab. 35b	
Bore Nominal Diameter		J7(Js7)		K6		K7		M6		M7		N7		P7	
over	incl.	upper	lower	upper	lower	upper	lower	upper	lower	upper	lower	upper	lower	upper	lower
mm		μm													
6	10	+8	-7	+2	-7	+5	-10	-3	-12	0	-15	-4	-19	-9	-24
10	18	+10	-8	+2	-9	+6	-12	-4	-15	0	-18	-5	-23	-11	-29
18	30	+12	-9	+2	-11	+6	-15	-4	-17	0	-21	-7	-28	-14	-35
30	50	+14	-11	+3	-13	+7	-18	-4	-20	0	-25	-8	-33	-17	-42
50	80	+18	-12	+4	-15	+9	-21	-5	-24	0	-30	-9	-39	-21	-51
80	120	+22	-13	+4	-18	+10	-25	-6	-28	0	-35	-10	-45	-24	-59
120	180	+25	-14	+4	-21	+12	-28	-8	-33	0	-40	-12	-52	-28	-68
180	250	+30	-16	+5	-24	+13	-33	-8	-37	0	-46	-14	-60	-33	-79
250	315	+36	-16	+5	-27	+16	-36	-9	-41	0	-52	-14	-66	-36	-88
315	400	+39	-18	+7	-29	+17	-40	-10	-46	0	-57	-16	-73	-41	-98
400	500	+43	-20	+8	-32	+18	-45	-10	-50	0	-63	-17	-80	-45	-108
500	630	+35	-35	0	-44	0	-70	-26	-70	-26	-96	-44	-114	-78	-148
630	800	+40	-40	0	-50	0	-80	-30	-80	-30	-110	-50	-130	-88	-168
800	1000	+45	-45	0	-56	0	-90	-34	-90	-34	-124	-56	-146	-100	-190
1000	1250	+52	-52	0	-66	0	-105	-40	-106	-40	-145	-66	-171	-120	-225
1250	1600	+62	-62	0	-78	0	-125	-48	-126	-48	-173	-78	-203	-140	-265

Examples of axial locating of bearings with tapered bore seated directly on the tapered journal or by means of an adapter or withdrawal sleeve are in Figure 13.

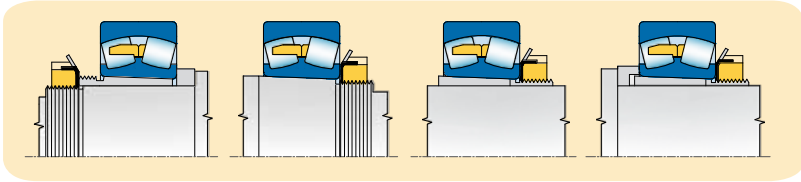

Figure 13

Permissible bearing axial load fixed by an adapter sleeve on smooth shafts without bearing resting on the shaft shoulder is calculated according to equation :

$$F_a = 3Bd \quad [N]$$

- | | | |
|-------|----------------------------------|------|
| F_a | - permissible bearing axial load | [N] |
| B | - bearing width | [mm] |
| d | - bearing bore diameter | [mm] |

If the axial displacement of the outer ring in the housing is not required, then we can use solution, when the face supporting or seating surface of the bearing cover, nut or snap ring are used. Bearings with grooves for snap ring (NR) do not require much space and their securing is simple. Examples - see Figure 14.

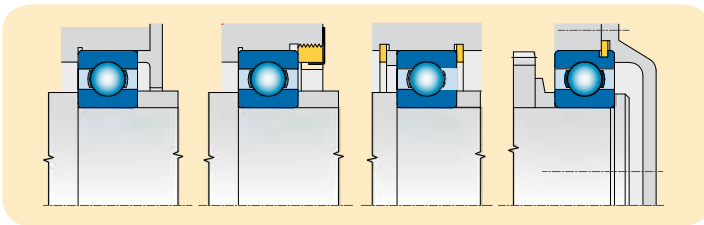

Figure 14

Abutment dimensions for each bearing shown in this publication are in the dimension tables.

3.3 SEALING

Sealing of the bearing space is very important, because damaging materials which can be found in the bearing environment influence it and often can cause its breakdown. Sealing also has an opposite function - it prevents the lubricant leaking out of the bearing and arrangement space. That is why sealing must always be designed with regard to operating conditions of machines or equipments, arrangement design, lubricating method, maintenance possibility and economic questions concerning production and utilization.

3.3.1 Non-Contact Sealing

Between non-rotating and rotating parts there is only a narrow gap when using this sealing. It is filled with grease. Using this sealing, wear of components from friction does not occur and that is why this sealing can be used for the highest rotational speeds and for high operating temperatures. Examples of a gap sealing are in Figure 15.

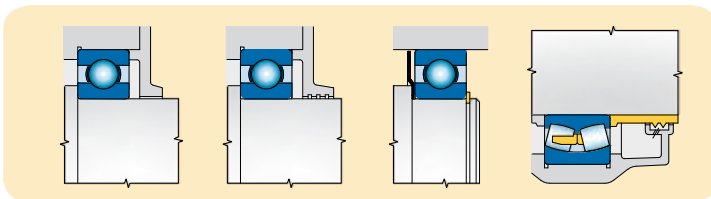
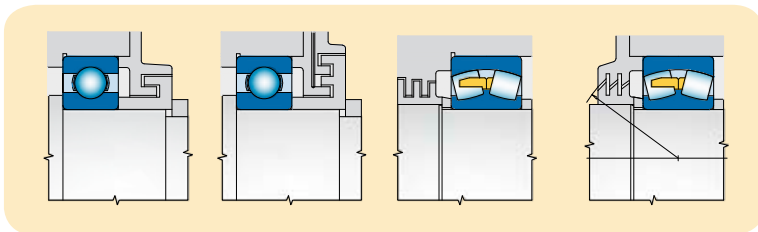

Figure 15

Another very effective sealing is the labyrinth sealing which can improve the sealing effect by a greater number of labyrinths or prolongation of sealing gaps. Examples - see Figure 16.

Figure 16



3.3.2 Rubbing Sealing

Rubbing sealing is created of elastic or soft, but sufficiently impermeable material, which is inserted between the rotating and firm part. Such a sealing is usually cheap and is suitable for various designs. The disadvantage is the sliding friction of the contacting surfaces, and therefore there is limited utilization for high rotational speeds. Sealing with a felt ring is the simplest (Figure 17). It is suitable for operating temperature - 40° to +160°C and for peripheral speeds to 7 m.s⁻¹ and sliding surface roughness max. Ra = 0,16, hardness min. 45 HRC or hard chromium plating. Dimensions of the felt rings are given by corresponding national standards.

A very wide-spread way of sealing is sealing with shaft washers (see Figure 18). Radial shaft sealwashers are made of rubber or other suitable plastic reinforced by steel sheet reinforcement. According to the material used they are suitable for operating temperature from -30° to +160°C. Permissible peripheral speed depends on sliding surface roughness :

- to 2 m.s⁻¹ is roughness max. Ra= 0,8,
- to 4 m.s⁻¹ is roughness max. Ra= 0,4,
- to 12 m.s⁻¹ is roughness max. Ra= 0,2.

Figure 17

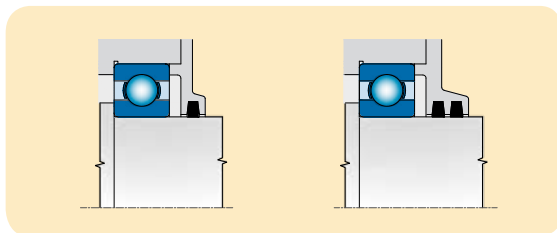
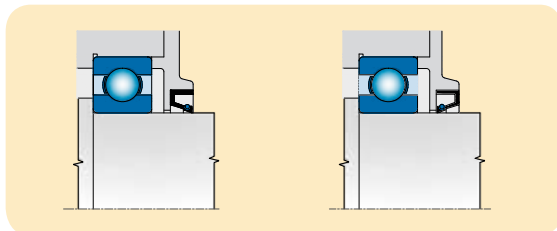

Figure 18



Except for mentioned most commonly used sealing rings there are rubbing sealing designs which use the just formed sealing rings made of rubber, plastic, etc., or special spring rings. This sealing is chosen either for applications with high requirements on bearing space sealing (great environment pollution, high temperature, chemical substance influence), or for economic reasons by mass or series production. Examples (see Figure 19).

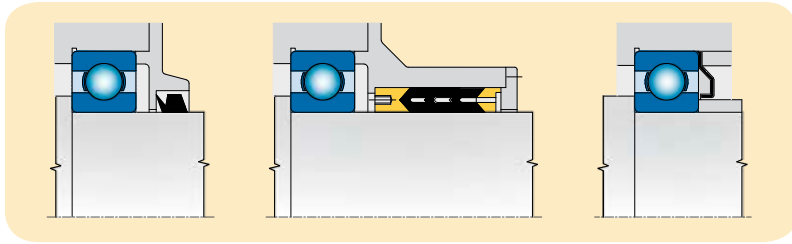

Figure 19

3.3.3 Combined Sealing

Increase sealing effect can be reached by non-contact and rubbing sealing combination. Such a sealing is recommended for wet and polluted environment. Example - see Figure 20.

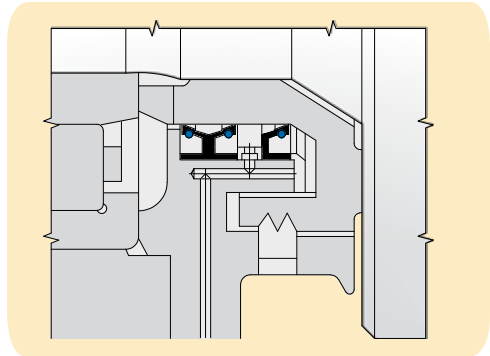

Figure 20

4. BEARING LUBRICATION

The correct bearing lubrication has a direct influence on the bearing life. Lubricant creates between the rolling element and bearing ring a carrying lubricating film which hinders their metal contact. It lubricates surfaces where friction arises, it has cooling effect, it protects the bearing from corrosion and in many cases seals the bearing space.

In the most cases - approximately 90%, bearings are lubricated with grease or oil, in rare exceptions by other lubricating means. When deciding which lubricant and which lubrication type should be used, operating conditions, characteristic qualities of the lubricant, equipment design and operating economy should be taken into account.

4.1 GREASE LUBRICATION

In the design practice grease lubrication is preferred to oil lubrication from the point of view of arrangement simplicity, utilization of the sealing capabilities and simple maintenance. For reliable bearing operation 1/3 to 1/2 of its free space is filled with grease at the first assembly. A greater grease amount has negative influence on the operation. Higher passive resistances cause the inner bearing space warming up undesirably, which can lead to its breakdown. Bearings making only a small number of revolutions during operation, from the point of view of corrosion protection should be completely filled.

4.1.1 Relubrication Interval

Relubrication interval is the period during which the grease has the necessary lubricating properties. After this period bearing must be relubricated, and old lubricant must be removed from the bearing space completely. Relubricating period depends on the bearing type and size, rotational speed, operating temperature and grease quality. The recommended relubrication period for individual bearing types at normal load ($P \leq$

0.15 C) and normal operational conditions is shown in diagrams in Figure 21 and 22. The diagrams are valid for common greases and temperatures to +70°C. For temperatures over +70°C, the relubrication period is shortened for each 15°C on the half of original value. For temperatures under +40°C the relubrication period can be doubled.

For small sized, especially single row ball bearings, the relubrication periods are several times longer than the bearing life, that is why the bearings are, as a rule, not relubricated.

For this reason it is advantageous to use these bearings shielded or sealed on both sides and filled with grease. For some rotational speeds the relubrication period is out of the diagram curve i.e. the permissible limit for grease lubrication has been reached and oil lubrication should be used.

Necessary grease quantity for relubrication is calculated from the equation :

$$Q = 0,005 \text{ DB [g]}$$

- Q - grease quantity [g]
 D - bearing outer diameter [mm]
 B - bearing width [mm]

For bearings with higher rotational speed requiring a more frequent relubrication, it is necessary to remove the used lubrication from the bearing space so that temperature increase should not occur. For this reason the grease escape valve is suitable.

4.1.2 Bearing Greases

Bearing greases are produced most often of quality mineral or synthetic oils (sometimes with additives), thickened with fatty acid metallic soaps. Greases must have good lubricating properties and high chemical, temperature and mechanical stability. The grease list of bearing lubricants is in Table 36.

Rolling Bearing Grease Properties				Tab. 36
Kind of Grease		Properties		
Thickening Agent	Basic Oil	Operating Temperature Extent [°C]	Resistance against Water	Application
lithium soap	mineral	- 20 ÷ 130	resistant	multi-purpose lubricant
lime soap	mineral	- 20 ÷ 50	high resistance	good sealing effect against water
soda soap	mineral	- 20 ÷ 100	irresistant	emulsifies with water
aluminium soap	mineral	- 20 ÷ 70	resistant	good sealing effect against water
complex lithium soap	mineral	- 20 ÷ 150	resistant	multi-purpose lubricant
complex lime soap	mineral	- 30 ÷ 130	high resistance	multi-purpose lubricant suitable for higher temperatures and load
complex soda soap	mineral	- 20 ÷ 130	resistant	suitable for higher temperature and load
complex aluminium soap	mineral	- 20 ÷ 150	mineral	suitable for higher temperature and load
complex barium soap	mineral	- 30 ÷ 140	resistant	suitable for higher temperature and load
bentonite	mineral	- 20 ÷ 150	resistant	suitable for high temperatures at low rotational speed
polyurea	mineral	- 20 ÷ 160	resistant	suitable for high temperatures at medium rotational speed
lithium soap	silicon	- 40 ÷ 170	high resistance	suitable for wide temperature range at medium rotational speed
complex barium soap	ester	- 60 ÷ 140	resistant	suitable for higher temperatures and higher rotational speeds

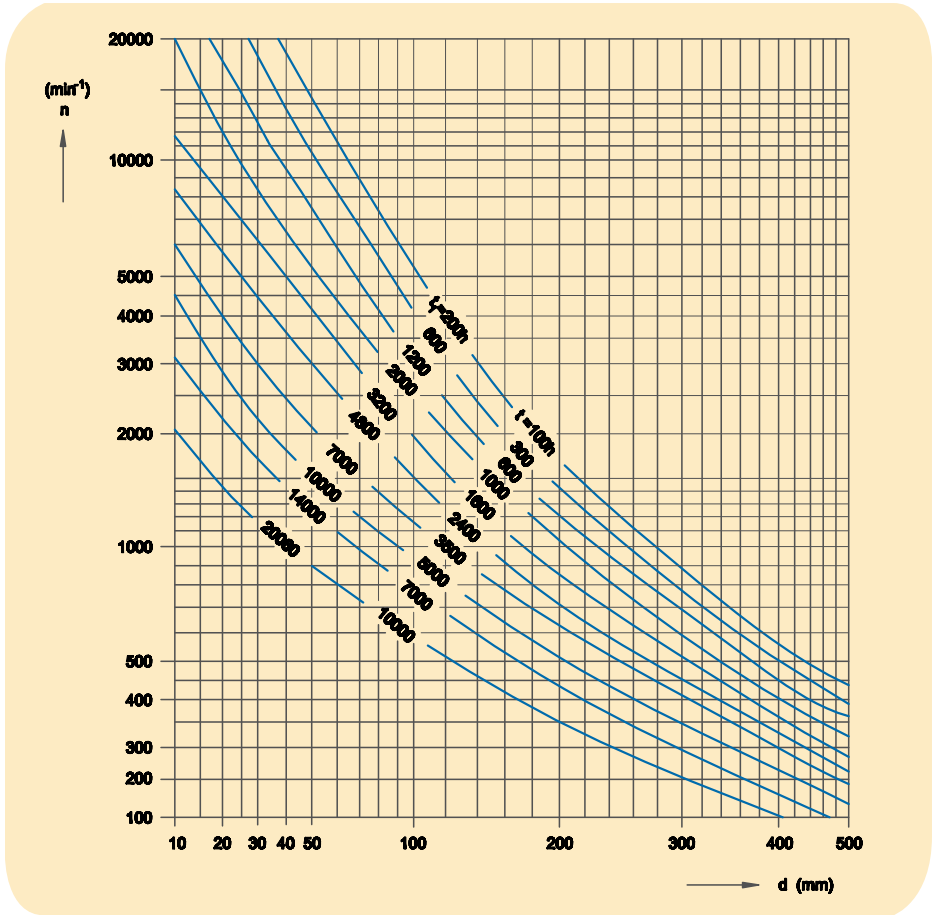

Valid for ball and cylindrical roller bearings

Figure 21

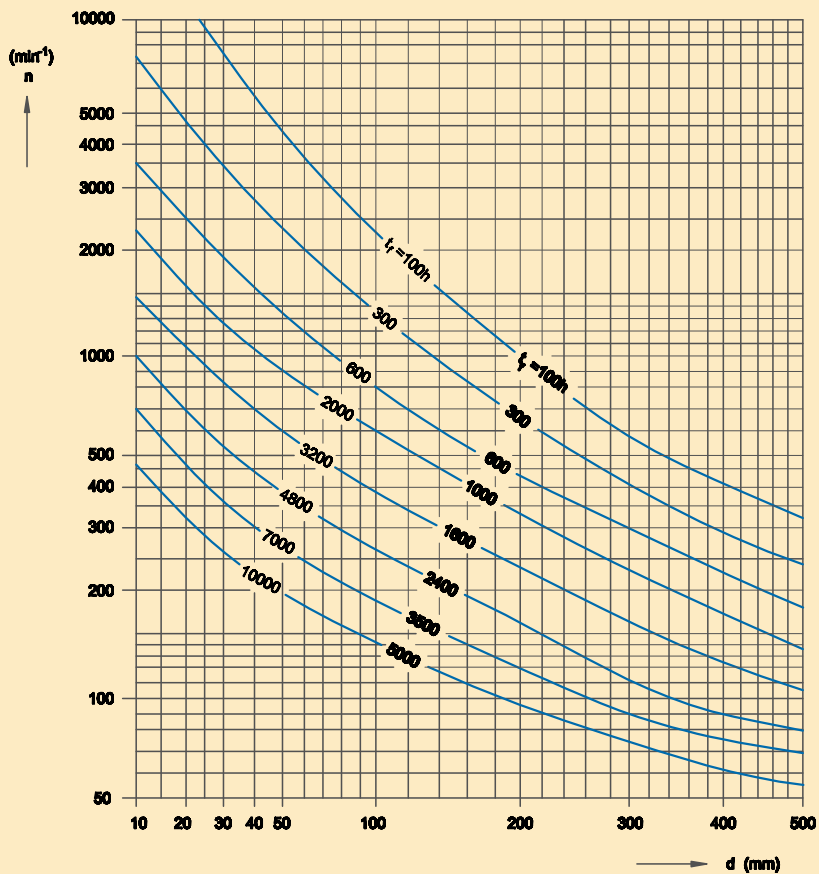

Valid for double row spherical roller bearings,
single row tapered roller bearings and thrust ball bearings

Figure 22

4.2 Oil Lubrication

Oil lubrication is used, when operating rotational speed is so high that the grease relubrication period is too short. Another reason can also be the necessity of heat transfer from the bearing, or the high temperature of environment, which does not enable utilization of grease, or if surrounding parts are already lubricated by oil (e.g. geared wheels in the gear box). Except for some cases, spherical roller thrust bearings are always lubricated by oil.

When oil lubricating, lubricating must be secured both at starting and during operation. Excess oil increases temperature and bearing temperature.

Oil feed into bearing is secured in various design ways, out of which oil bath lubrication with oil level reaching middle of the lowest rolling element, oil circulation lubrication, jet lubrication, oil mist lubrication etc., are the most common.

4.2.1 Bearing Oils

For bearing lubrication mostly refined oils with good chemical stability which can be improved by antioxidizing agents are used.

The decisive oil property is kinematic viscosity which decreases with increasing temperature. Suitable oil viscosity ν_1 can be stated according to the diagram (see Figure 23) dependence on the bearing mean diameter $d_s = (d+D)/2$ and rotational speed n . If the operating temperature is known or it can be found out, according to the diagram (see Figure 24) suitable oil and viscosity ν at internationally standardized temperature 40°C being necessary for calculation of ratio κ is determined.

By ratio $\kappa < 1$ it is recommended to use EP oil with additives which improve the oil film load rating. By value κ decrease under 0.4 oils with EP additives are always used.

If the ratio κ is greater than 1, improved arrangement reliability is reached in operation.

Example :

- bearing $d = 180$ mm, $D = 320$ mm, $d_s = 250$ mm
- rotational speed $n = 500$ min⁻¹
- presumed operating temperature 60°C

For these conditions according to diagram (see Figure 23) the minimum kinematic viscosity is $\nu_1 = 17$ mm².s⁻¹. If the operating temperature is 60°C , the oil selected according to the diagram (see Figure 24) at standardized temperature 40°C must have kinematic viscosity ν min 35 mm².s⁻¹.

For thrust spherical roller bearings the lubricating oil kinematic viscosity is approximately stated in dependence on $n \times d$, where n is the bearing rotational speed in revolutions per minute and d is the bore diameter in mm, according to table 37. Lower values are valid for bearings with lower load, for which is valid $P_a \leq 0,1 C_a$. Higher values are valid for $P_a > 0,1 C_a$.

Oil Viscosity for Spherical Roller Thrust Bearings		Tab. 37
d.n	Kinematic Oil Viscosity mm ² .s ⁻¹ at 40°C	
1 000	250 to 550	
10 000	100 to 250	
100 000	45 to 100	
200 000	30 to 80	

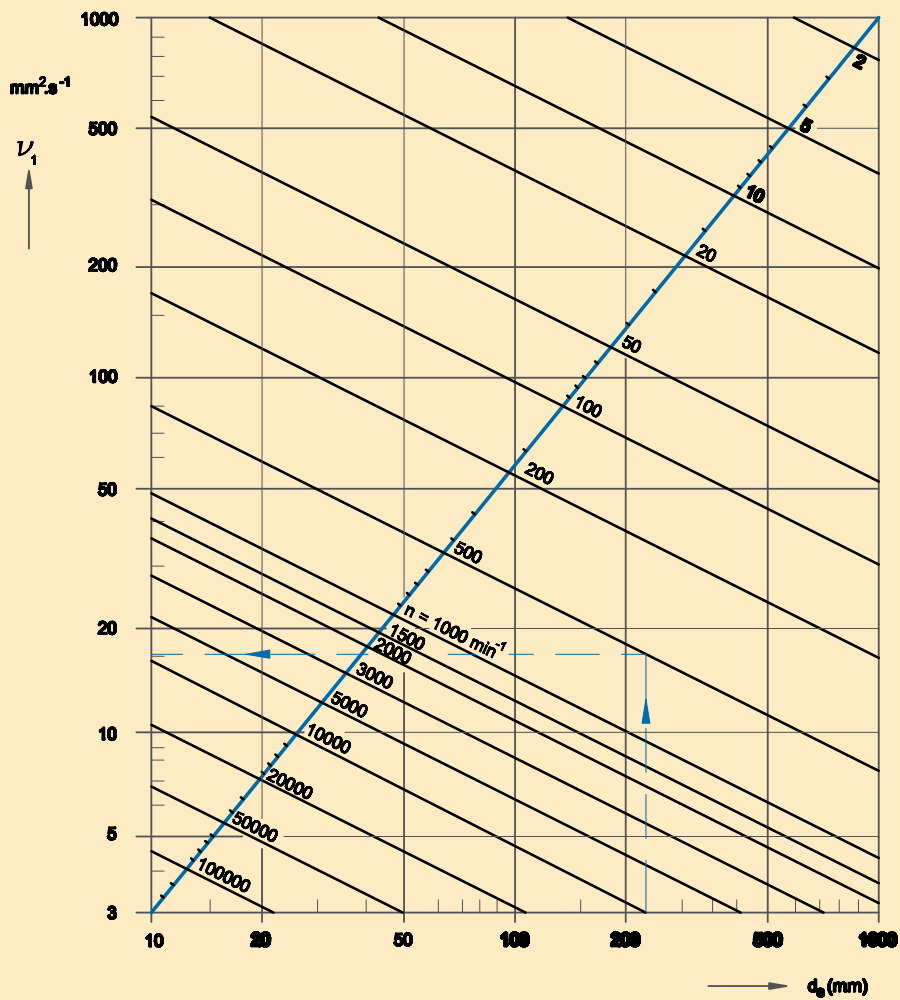

Figure 23

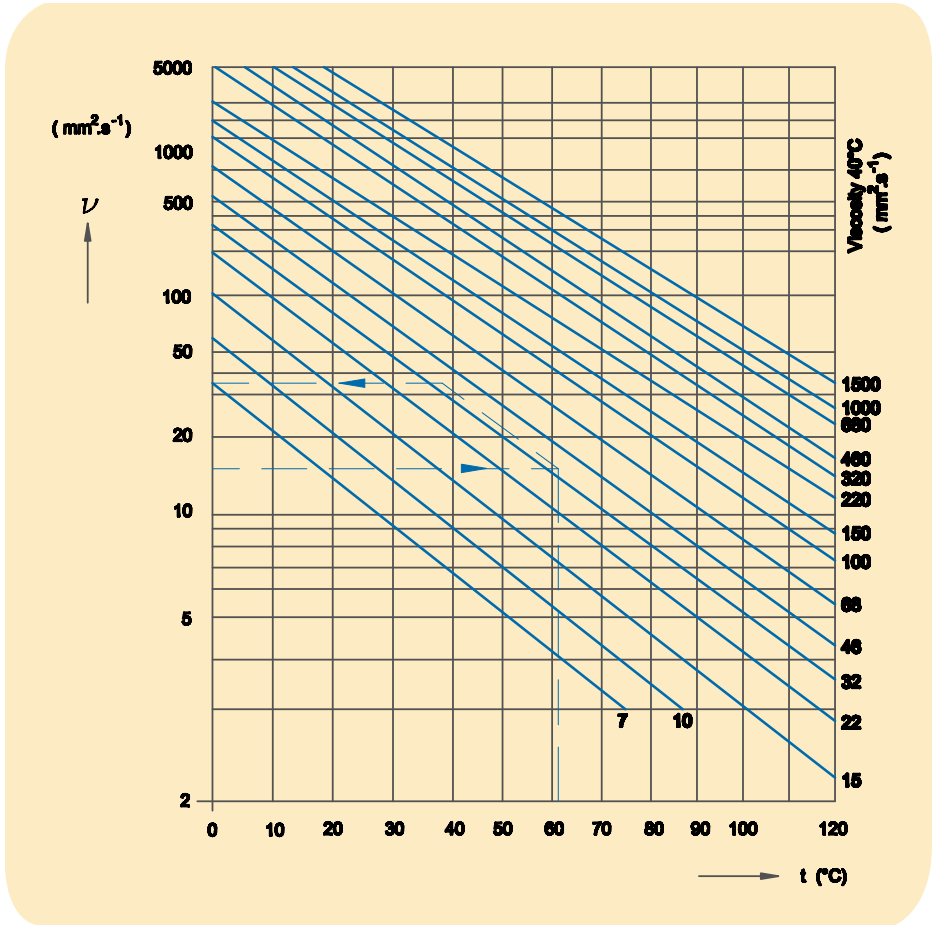

Figure 24

4.3 Lubrication with Solid Lubricants

Solid lubricants are used for bearing lubrication when the grease or oil cannot fulfil the requirements for reliable lubrication in conditions of limiting friction or from the viewpoint of high operating temperatures, chemical influences, etc.

5. RELIABLE RUNNING CONDITIONS OF ROLLING BEARINGS

Reliable running of rolling bearings depends not only on the quality of bearings itself.

There are also other factors affecting the service life of the rolling bearing, especially operating environment, technical mounting and correct maintenance.

It is necessary to keep machines in a good operational condition.

Besides securing necessary co-axial state it is important to protect bearings from an extreme temperature, moisture and pollution.

It is necessary to choose the correct mounting process and select suitable tools to avoid of damaging bearings during the mounting already.

The important precondition for the maximal service life of bearings is to keep the plans of oiling and maintenance, to control operational conditions.

5.1 STORAGE OF ROLLING BEARINGS

Dry and dust-free space with almost constant temperature creates the best conditions to store bearings. Bearings must be stored in original not damaged wrapping and taken out immediately before mounting. Big bearings must be put horizontally and supported all around in order not to deform the rings.

Bearings are preserved at the producer's for the storage period of 24 months.

The storage conditions must fulfill these requirements:

- The temperature in the store-room must be from 5°C to 35°C. The thermal amplitude must not exceed 5 °C.

- Rolling bearings must not be put on the fresh wood shelf, near cold walls or on the stone floors.

- Relative air moisture must not exceed 60%.

There is a danger of corrosion at higher relative moisture.

- Bearings must not be put too near heating or water piping.

- Bearings must not be exposed to the direct sunshine.

- No chemicals may be stored at the same space with bearings (acids, ammoniacs, chloride of lime and etc.)

since they cause bearings corrosion.

Each store-room must have hygrometer and thermometer.

5.1.2 Influence of bearing clearance on its service life and accuracy of running

The size of a radial clearance of a radial bearing at constant operational conditions determines service life of a rolling bearing and reliability of operation of housing and also accuracy of running of a turning shaft, spindle. A very big radial clearance causes external weight that spreads at smaller number of rolling elements, and this way their weight increases and accuracy of shaft running worsen. The operational clearance of rolling bearings depends on its clearance size at not installed state, on overlap size of placement of an inner and outer ring and on thermal declivity between rings. The operational clearance cannot be measured at running, so the negative clearance may be generated, ergo pre-stress and, consequently, premature destruction of bearings may occur. Even though a bigger operational clearance might not ruin bearings quickly, it determines lowering of its load rating and durability. An axial clearance of a radial bearing is mostly not very important.

Axial bearings should not work with clearance because adverse gliding of rolling elements can appear between raceways of rings, caused by centrifugal forces and bearing torques. At high perimeter speed of axial ball-bearings, balls can glide oblique rolling direction under the influence of bearing torque, so spiral traces of jam are generated.

5.1.3 Relation of tolerance class of rolling bearing to its arrangement

The dimensional accuracy of dimensions and accuracy of running of rolling bearings complies with the international standards. Most of machine and equipment arrangements suit standard tolerance class P0. Bearings with higher tolerance than P0 are used in the arrangements requiring higher accuracy of running, e.g. for placement of working machines and instruments spindle, etc., and also when a bearing exceeds its limiting speed. The abutment components of the arrangement in higher tolerance class must be produced. It is also necessary to secure adequate toughness of the arrangement at variable loads, low temperature fluctuation in bearings and possibility of the bearing clearance adjustment to reach higher accuracy of the arrangement running.

5.1.4 Rolling bearings arrangement design

The arrangement design must be developed not to allow additional loads when mounting and running; axial clamping (overload) of bearings when mounting and shaft and housing dilatation when running. Therefore a bearing seating alignment and adequate toughness and dimensions of abutment components must be considered when developing the design.

The special attention to the arrangement design must be paid in relation to the oiling system and sealing of bearings space. It is necessary to ensure regular re-lubrication in bearings lubricated by grease. If the re-lubrication intervals are short it is necessary to build a slinger ring into the housing in order not to overfill the bearing space with grease and to overheat a bearing. The oil lubrication is used if the operation speed and temperatures don't allow to use grease lubrication, and if the bearings are located in the space where oil is used for lubrication of other components, e.g. gear-wheels.

The selection of the method of the oil lubrication (oil bath, circulating oil, oil drop, oil jet or oilmist) depends on operating conditions and lubricating system of the certain machine equipment.

The construction design must ensure that bearings have adequate quantity of oil not only at normal running but mainly when starting-up the machine. Excessive oil increases oil temperature.

For more details on lubrication see previous chapter.

5.2 MOUNTING OF ROLLING BEARINGS

5.2.1 MOUNTING OF ROLLING BEARINGS

Housing bearings	Mounting method	Mounting equipment
Cylindrical Journal		
small bearing	cold	cold mounting cases, hammer, mechanical or hydraulical press
	hot	hot mounting inductive equipment, heating-up plate, heating-up box
medium bearing	hot	hot mounting inductive equipment, heating-up box, hot-air heater, heating-up tub, inductive heating-up equipment
large bearing	hot	large bearing hot mounting inductive equipment, heating-up box, hot-air heater, heating-up tub, inductive heating-up equipment
Tapered Journal		
small bearing	cold	small bearing cold mounting lock nut, hook spanner, press
medium bearing	cold	medium bearing cold mounting lock nut, hook spanner, hydraulic nut, pump
large bearing	hot	large bearing hot mounting heating-up equipment, hydraulic equipment
Adapter and Withdrawal sleeves		
small bearing	cold	small bearing cold mounting lock nut, hook spanner, hydraulic nut, pump
medium bearing	cold	medium bearing cold mounting lock nut, hook spanner, hydraulic nut, pump
large bearing	hot	large bearing heat mounting heating-up equipment, hydraulic nut, pump

Small bearing: the bore diameter < 75 mm
 Medium bearing: the bore diameter 75 to 200 mm
 Large bearing: the bore diameter >200 mm

5.2.2 Mounting workplace

It is necessary to protect bearings from dirt, foreign elements and shocks. Therefore it is necessary to choose dry and dust-free mounting workplace. No components can be produced and modified in a mounting workplace (sawing, grinding, welding, etc.) nor pressed air can be used so the saw-dust, dust and other foreign elements do not penetrate into a bearing. When foreign elements such as dust, abrasives, etc. penetrate into a bearing, together with the lubricant they create material, damaging raceways, rolling elements and the cage. Accuracy of a bearing is lowered this way. Thicker dirt penetrating into a bearing will roll into raceways by rolling bodies and damage the raceways which will put the bearing out of service prematurely.

5.2.3 Bearing preparation for mounting

Before starting the mounting it is necessary to check whether the designation on the packaging and the bearing designation complies with data on the drawing. It is important that not only the basic designation but also the supplementary designation which determines the bearing design comply with the data on the drawing. Bearings producers protect bearings from corrosion by preservative material which is neutral to common plastic lubricants and oils and has good lubricating properties. Therefore bearings are not washed before mounting. If they are preserved by slushing grease (bearings which are still stored at users premises), the grease is removed from the bore, bearings surface and the front of bearings rings only. If a grease-preserved bearing is lubricated by circulating oil when in operation, it needs to be washed out because of a danger that slushing grease blocks ducts or oil feed holes.

Benzoline with 5 to 10% part of light mineral oil, benzole, naphtha, pure petroleum at common temperature. Inorganic cleansers can also be used to wash out bearings at the temperature of 70 to 80°C. Bearings made of light metals must not be washed out by inorganic cleansers. When washed out, bearing is immediately preserved by light oil.

5.2.4 Preparation of arrangement components for mounting

Before mounting all the components must be properly cleaned and cleared of burrs. Also lubricating holes and threads must be properly cleaned. Housing components areas must be produced within determined tolerance. The violation of bearing operation can be caused by exceeding permissible dimensional and shape deviations and not keeping the supporting front surfaces for bearings rings in an upright position. Therefore

it is necessary to check out properly determined dimensions of housing areas on the shaft and in the housing before mounting. If there are no special data on drawing, it generally stands that ovality and taper ratio must not exceed half of the tolerance zone. Then it is necessary to check out shoulder and chamfer of shaft bypass. Grooves and other defects must not be in front of the shoulder. The circularity, the angle of the taper and the surface straightness of the tapered surface must be checked out at the tapered housing areas. The taper ratio of the shaft must correspond with the tapered bore of the inner ring. For most of bearings types the taper ratio is 1:12, at some types it is 1:30. Figure 25 shows measuring of the shaft diameter, and the Figure 26 shows measuring of the bearing housing bore.

Figure 25

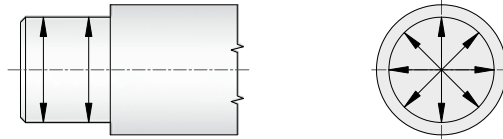
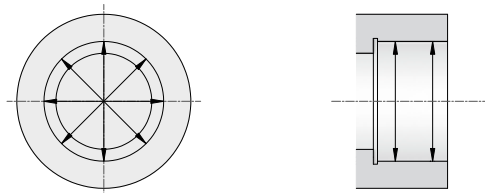

Figure 26



5.2.5 Control of housing areas

The micrometer calipers adjusted by control gauge is used for measuring of the shafts. The inside calipers also adjusted by control gauge measures pillow blocks. The dial indicator (see Figure 27) with 0,001 mm accuracy is used for evaluation.

The tapered gauge (see Figure 28) is the simplest gauge for small taper areas. The method of bluing shows whether the taper ratio of the journal corresponds with the gauge and it is corrected until the gauge sits all over the width.

Figure 27

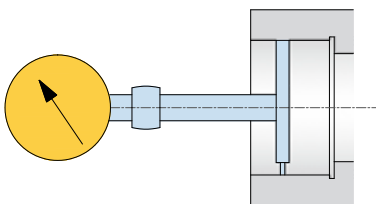
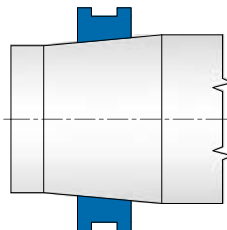

Figure 28



5.2.6. COLD MOUNTING

5.2.6.1 Cylindrical housing areas

Different constructions and bearings sizes require also different mounting procedures. The mounting force must always be applied on the firmly fitted ring when mounting of non-separable bearings (see Figure 29) e.g. single row ball bearings. If the force acts on the outer ring when mounting of the inner ring, it is transferred to the rolling elements and raceways of rings and can damaged them.

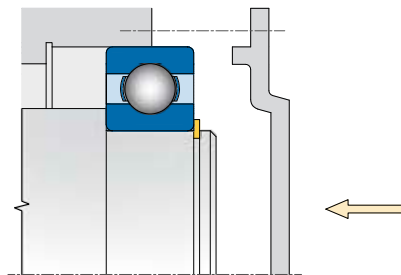

Figure 29

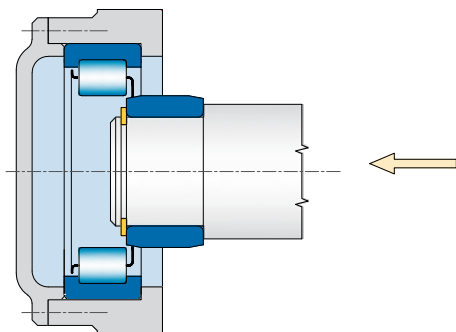

Figure 30

Mounting of separable bearings is simpler (see Figure 30), both rings can be mounted separately. The inner ring with the journal will be inserted into the outer ring after pressing. To avoid grooves on functional bearing areas when inserting a ring into a bearing, the screw-shape turn should be done.

In standard fitting, small bearings up to the diameter of approximately 75 mm can be cold pressed on the shaft. The shaft and bearing bore will be cleaned by a clean cloth and softly oiled up. Mechanical or hydraulic press is used when cold mounting (see Figure 31).

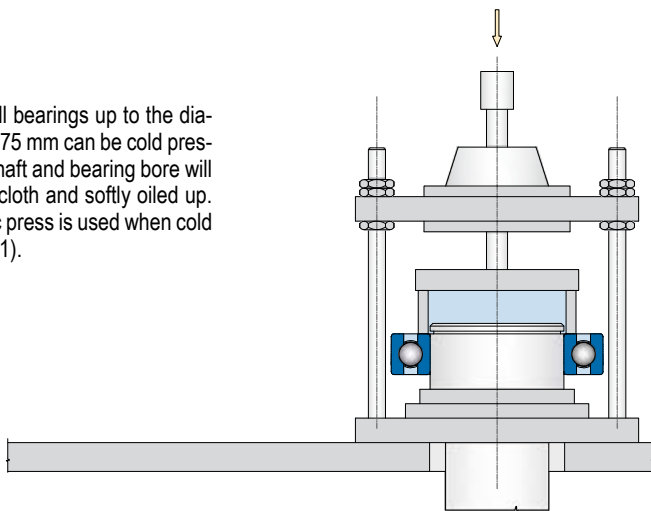

Figure 31

With no press available when fitting the bearing with minor overlap, it can be knocked on the journal by light hits of a hammer on mounting sleeve. A bearing ring can be knocked directly by the hammer under no circumstances. Mounting sleeves of soft steel with flat front area are suitable for mounting (see Figure 32). The diameter of this sleeve should be a little bigger than the diameter of the bearing bore. The outer diameter of the sleeve must not be bigger than the diameter of the front inner ring, whereas the cage damage could occur.

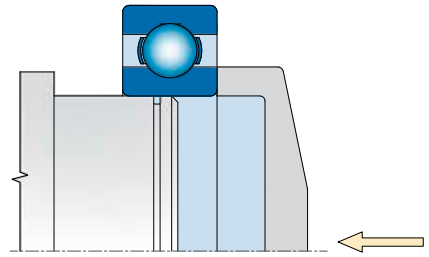

Figure 32

If the inner ring is solid fitted and the outer ring is slide fitted, the bearing is pressed onto the shaft first and then inserted together with the shaft into the housing. If both rings are solid fitted, they are mounted at the same time. The attachment is seated on both rings in this case (see Figure 33).

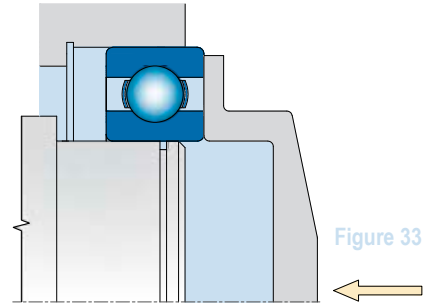

Figure 33

Balls overhang through the rings width in certain types of double row self-aligning ball bearings. The mounting attachment must have a recess for this reason (see Figure 34).

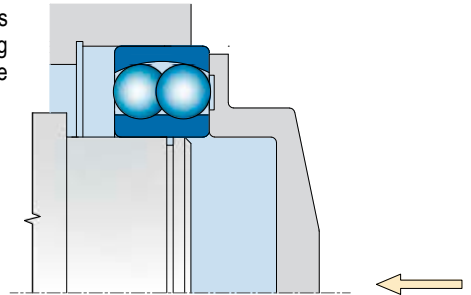

Figure 34

The seating areas can be damaged in press fitted Bearings made of light metal alloy. Therefore it is appropriate to heat up the bearing housing or to cool the bearings down. Mixture of dry ice and alcohol is used for cooling. The temperature of bearing rings must not drop under -50°C . Due to cage clearance the rollers might hit even the front area of the inner ring in bigger cylindrical bearings. Mounting sleeve facilitates mounting by guiding the rollers on raceway. (see Figure 35).

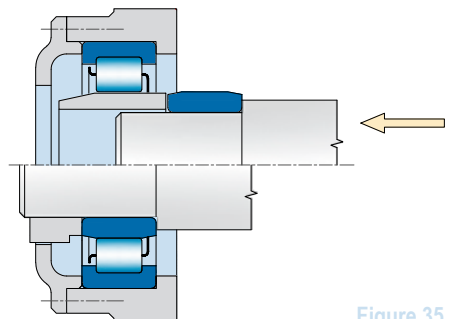

Figure 35

The proper clearance in millimeters is set up between rollers and flange on the inner ring according to the table 38 at mounting of the cylindrical roller bearing with one flange on the ring (type NJ).

Bearing size	hole	Diameter rows			Tab. 38
		NJ2	NJ3	NJ4	
04	20	0,55	0,55	0,6	
05	25	0,55	0,55	0,8	
06	30	0,6	0,6	0,9	
07	35	0,75	0,75	0,95	
08	40	0,8	0,8	1,0	
10	50	0,8	0,8	1,1	
12	60	1,0	1,0	1,3	
14	70	1,1	1,1	1,5	
16	80	1,25	1,25	1,6	
18	90	1,5	1,5	1,8	
20	100	1,65	1,65	1,9	
22	110	1,95	1,95	2,1	
24	120	2,0	2,0	2,4	
26	130	2,0	2,0	2,7	
28	140	2,15	2,15	2,8	
30	150	2,3	2,3	3,0	
32	160	2,5	2,5	3,1	
34	170	2,65	2,65	3,1	
36	180	2,65	2,65	-	

5.2.6.2 Conical housing areas

Tapered Bore conical hole bearings are either directly fixed onto the conical shaft or by clamping or stitching case onto the roller shaft. Housing areas on the shaft, on the case and in the bearing hole can be softly oiled up before mounting. At inserting of a bearing on the cone, the inner bearing ring stretches and the radial clearance is lowered this way. Lowering of the radial clearance will become the gauge of the inner ring fixing. Lowering of the radial clearance is determined as the difference between the radial clearance before and after a bearing mounting. The radial clearance is measured before mounting, during inserting of the bearing on the cone it is constantly controlled until it will reach necessary lowering, and like this will also reach correct fixing on the shaft.

Instead of lowering the radial clearance, an axial displacement of a bearing on the cone can be measured. The table 40 contains values of lowering of the radial clearance. The radial clearance is measured by the slot gauge (see Figure 36). It is necessary to measure the radial clearance in both rows of spherical rollers at double row spherical bearings. The inner ring is not axially displaced opposite to the outer ring, guaranteed only if the clearance in the both of rows of spherical rollers is the same. The inner and outer ring at spherical roller bearings can be mounted separately. Instead of lowering the radial clearance the stretch of the inner ring can be measured by the stirrup micrometer, if the inner ring is takable away. Hydraulic or mechanical equipment is used to press a bearing on the conical housing area.

Small and medium size bearings can be fixed onto the conical pivot by a clamping nut (see Figure 37).

The hook wrench is used for tightening of the nut.

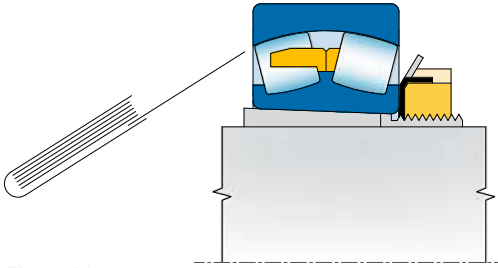

Figure 36

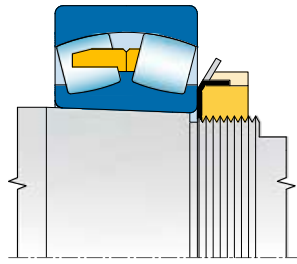

Figure 37

Bearings with clamping case (see Figure 38) are pressed on the conical area of the case by the clamping nut. The state of the case, the nut and pad is checked out before mounting. The radial clearance is measured and preserving agent is removed from the bearing bore and surface. First the clamping case is put on the pivot during mounting, then the bearing safety pad and nut are inserted. The bearing is inserted on the cone by tightening until its radial clearance is lowered to specified value.

Pressing force is considerably big at big bearings. Therefore it is recommended to spread mixture of oil and colloid graphite on the thread nut and its front area. Clamping cases are most used for smooth shaft, therefore during mounting it is proper to secure bearing position by the holding pad (see Figure 39) which is removed after mounting.

All mounting areas are first cleaned during mounting of a bearing onto the tightening case. The bearing is put on the shaft and the tightening case is inserted (see Figure 40) into the gap between the shaft and bearing bore so far away until reaching necessary lowering of the radial clearance.

Bigger force is necessary for pressing the case in at bigger bearings. The fixing nut with pressing screws (see Figure 41) makes mounting easier in such cases.

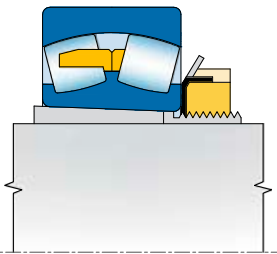

Figure 38

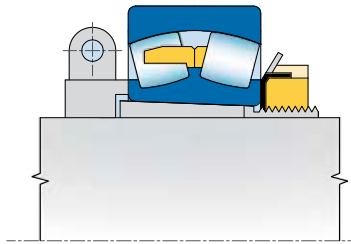

Figure 39

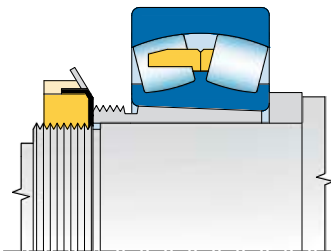

Figure 40

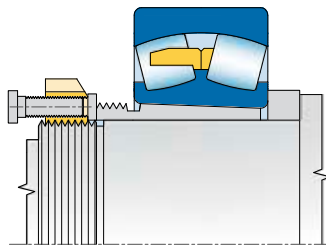

Figure 41

5.2.7 HEAT MOUNTING

Force necessary for pressing the ring in has quadratic increase with linear increase of bearing dimensions at the pressure changeless area. Therefore it is reasonable to heat mount bigger bearings or by pressure oil. Heat mounting is convenient for bearings with roller hole, pressure oil is more convenient for bearings with the conical hole. Both of the methods can be used for both holes shapes. By heating up from 70 to 80°C, the suitable rings stretching for easy bearing inserting can be reached. Higher temperatures (over 100°C) lower bearing hardness and its service life and can also change its dimensions (besides bearings stabilised for running at higher temperature). Bearings with cover (-2Z, -2ZR) and with sealing (-2RS, -2RSR) can be heated up to maximal temperature 80°C, however, never in oil bath.

5.2.7.1 Oil bath heating up

The transformer oil is the most proper for oil heating up of bearings. Bearings are put on the grate or hung (see Figure 42) over the grate, which is placed over the heating vessel bottom, to protect them from the direct contact with the heating bottom, this way also avoiding of rings overheating. The oil temperature moves from 70 to 80°C and must be controlled and regulative. The screw-shape turning around of the component being mounted to the pivot makes bearings mounting easier. Afterwards the cooling ring is still knocked by the mounting case to bear on the supportive front over all the perimeter.

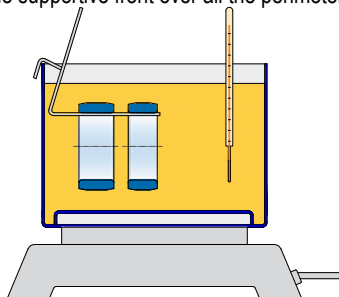

Figure 42

5.2.7.2 Heating up on heating plate and in heating box

Bearings with the bore smaller than 100 mm are heated up by electric heating plates equipped with the temperature controller. Spiral heaters with the temperature controller with accuracy of $\pm 2^\circ\text{C}$ are proper for heating up bigger bearings with the bore from 100 to 300 mm. Electric heating boxes with the built-in regulative thermostat and protective equipment against bearings overheating are proper for heating bigger quantity of small and medium bearings.

5.2.7.3 Hot-air heater heating up

The hot-air heater bearings heating up is a reliable and pure method. The temperature is regulated by the thermostat. This method protects bearings also from pollution. The disadvantage is that heating up takes relatively long time, therefore relatively big heaters must be available during serial mounting.

5.2.7.4 Inductive heating up

The equipment for inductive heating up is proper to use for fast, reliable and pure hot mounting, even at smaller quantity of bearings. The inductive mounting equipment provides possibility to heat up inner rings of cylindrical roller bearings and needle roller bearings with the bore diameter from 100 mm. This equipment is economical when there is serial mounting of bigger quantity of cylindrical roller bearings inner rings, for example at axle bearings of track vehicles or at metallurgical plants and rolling-mills equipment.

5.2.8 PRESSURE OIL MOUNTING OF BEARINGS

The oil under the pressure approximately 12,5 to 75 MPa is brought between the contact areas at the pressure oil mounting method. The oil film divides the inner bearing ring and pivot so much that they can move on each other with minimal force without risk of damaging the surface. The pure mineral oil should be used for the pressure oil mounting. The light mineral oil with viscosity from 45 to 68 mm² · s⁻¹ at 40°C is mostly proper. It is better to use less viscous oil which reliably escapes from the contact housing areas after mounting. There are shaft grooves, feed channels and also connecting threads of oil injector or the oil pump terminal for pressing the oil in between the contact ring and pivot areas (see Figure 43).

Pressure oil cases with grooves are used for the big bearings fixed onto the shaft by clamping or tightening cases. The tightening cases have grooves on the surface and in the bore. The clamping cases (see Figure 44) have grooves on the surface and oil feed on the side of the thread or on the side of the cone.

The oil injector having oil content from 10 to 25 cm³, depending on the size, is proper for dividing the pressure oil at small and medium dimensions and pressure up to 250 MPa can be reached.

The oil pump is better when is necessary bigger quantity of oil at medium and large dimensions.

5.2.8.1 Mounting of bearings with tapered bore

The solid housing of the inner ring of the bearing with the tapered bore can be reached by pressing onto the shaft while the inner ring is flexibly stretched, causing lowering of the bearing radial clearance. Lowering the size of the starting radial clearance represents the gauge for the adequately solid housing on the cone. The difference between the radial clearance before and after mounting represents the radial clearance lowering. Therefore the real value of the radial clearance before mounting must be first found out by measuring. After pressing the bearing on the cone, the clearance is being controlled so long time until it reaches necessary lowering and by that also required housing solidity.

Fixing nuts, forcing off screws or hydraulic nuts are used for pressing (see Figure 45 – 47). Depending on the size hydraulic stitching and clamping cases have connecting threads for the pressure oil feed. By screwing, reduction and a steel pipe high-pressure hose pump is fixed to the case.

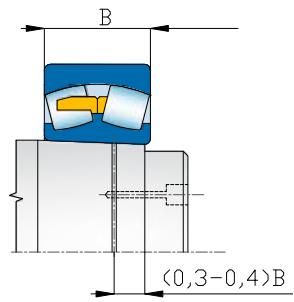

Figure 43

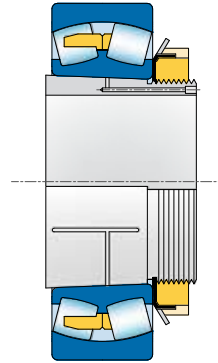

Figure 44

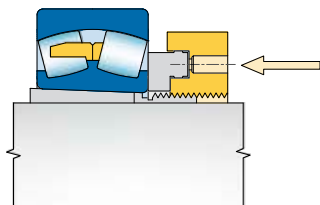

Figure 45

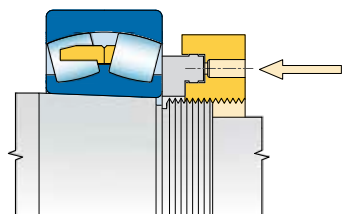

Figure 46

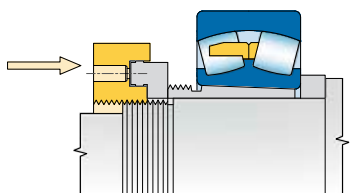

Figure 47

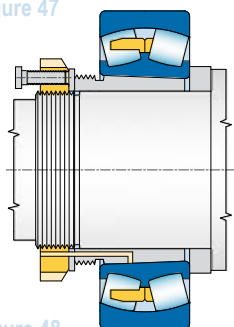

Figure 48

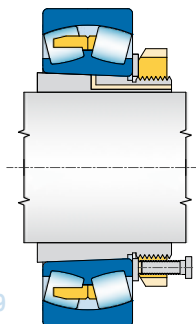

Figure 49

The oil is forced in between the contact areas during the mounting. The axial mounting force is being reached by 6 or 8 forcing off screws in the nut which is screwed onto the shaft (the Figure 48) or on the case (see Figure 49).

By forcing off the screws the mounting pad prevents damaging of the stitching case or the bearing. The oil feed goes through the nut screwed onto the shaft after pressing the stitching case in. The axial displacement of the bearing or stitching case is determined according to the required radial clearance lowering. The bearing must be oil pressure lightened during the radial clearance measuring.

After reaching the specified radial clearance lowering and oil pressure release, if the pressure oil is used at mounting, depending on the size, it is necessary to leave the bearing under the nut or screws prestress still 15 to 30 minutes, let oil run out of the conical areas.

5.2.9 MOUNTING OF DOUBLE ROW CYLINDRICAL ROLLER BEARINGS WITH TAPERED BORE

NN30K and NNU49K bearings mounting requires the special process. Measuring of a rotary track and rollers cover circle by the special gauge determines the size of the radial clearance or prestress.

The gauge is chosen at mounting, considering the bearing construction and if the ring is takable away or not this represents the specified radial clearance or prestress. The diameter difference of the outer ring rotary track and rollers cover circle represents the specified radial clearance or prestress at the cylindrical roller bearings.

Figure 50 shows the gauge principle for measuring NN30K bearings. First the diameter of the rotary track on the mounted outer ring is measured by the gauge during mounting. This diameter will be moved on the rollers cover circle gauge and the gauge will be put on the inner ring with rollers. The inner ring is moved so far away onto the cone until the microcator shows the value of the specified clearance or prestress.

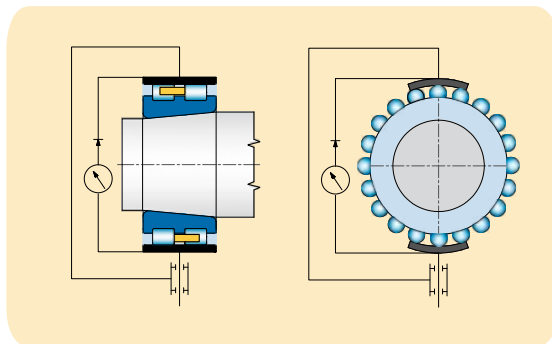

Figure 50

The diameter difference of the rollers cover circle and inner ring rotary track represents the specified radial clearance or prestress at NNU49K cylindrical roller bearings. Figure 51 shows the cover circle gauge principle for these bearings. The gauge is put into the mounted outer ring with the rollers and the cover circle diameter is set up. The cover circle diameter is removed onto the inner ring by the gauge. The specified clearance respectively prestress is reached by inserting the inner ring onto the cone. The usual gauge with 0,001 mm accuracy measures rotary tracks diameters.

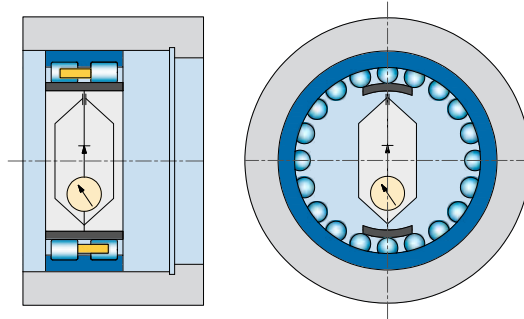

Figure 51

The cone is checked out by the special gauge before mounting (see Figure 52). The slider leans against the cone by four tempered, grinded and lapped batters forming the 90° angle. The gauge is accurately axially set by the stop on the front or back side of the slider. The measuring sleigh between batters pulled on the attached cylindrical roller bearings bear on the cone by measuring touch. The microcator or gauge body leaning against the sleigh determines differences from the cone diameter. The second microcator on the measuring sleigh, leaning directly against the cone measures difference in the degree of the taper. The measuring accuracy is 1 μm.

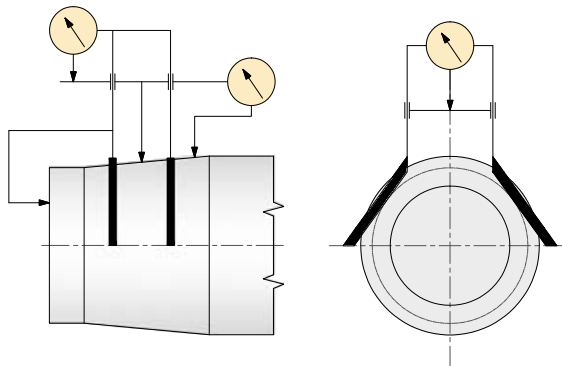

Figure 52

If such a gauge is not available, the radial clearance or prestress can be set up by the radial displacement of the bearing on the cone. It is recommended to pass the inner ring onto the cone so far away that there is left the small measurable clearance (the tab. 39).

Tab. 39

Hole from	(mm)	80	180	280	400	
Bearing to		80	180	280	400	500
Radial clearance	(μm)	10	10	15	20	25

This measured axial clearance determines the size of the axial displacement on the Figure 53 diagram.

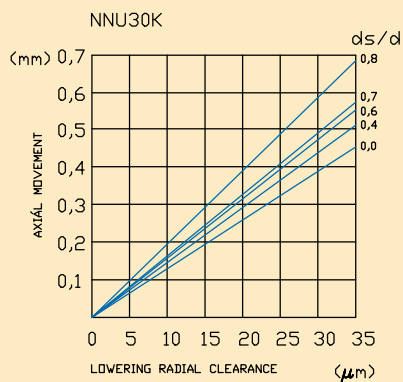
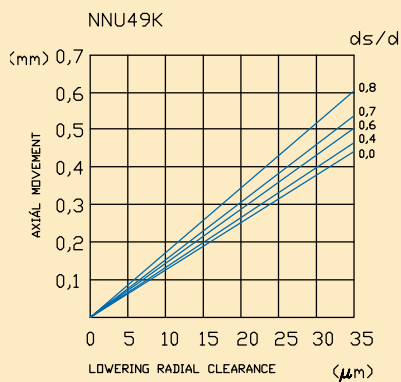
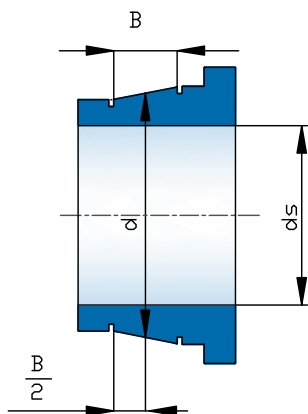

Figure 53

It is recommended to verify the housing temperature by the test of bearings mounted with prestress. It depends on the housing construction, size, and bearing type which proper mounting method will be chosen in separate cases.

The accuracy of the set up radial clearance and bearing prestress are controlled by the watching bearings temperature at testing running of the high-turn spindle. Testing running takes so long time until the bearings temperature is stabilised. The testing time is from ½ to 3 hours depending on the machine size. The constant temperature from 50 to 60°C is acceptable determining value for the properly chosen clearance or prestress.

Tab. 40

Explicit diameter d (mm)		Required radial clearance lowering	Required displacement on cone 1:12		Required displacement 1:30	
from	to		on shaft	on case	on shaft	on case
24	30	0,015-0,020	0,30-0,35	0,30-0,40	-	-
30	40	0,020-0,025	0,35-0,40	0,35-0,45	-	-
40	50	0,025-0,030	0,40-0,45	0,45-0,50	-	-
50	65	0,030-0,035	0,45-0,60	0,50-0,70	-	-
65	80	0,040-0,050	0,60-0,75	0,70-0,85	-	-
80	100	0,045-0,060	0,70-0,90	0,75-1,00	1,70-2,20	1,80-2,40
100	120	0,050-0,070	0,70-1,10	0,80-1,20	1,90-2,70	2,00-2,80
120	140	0,065-0,090	1,10-1,40	1,20-1,50	2,70-3,50	2,80-3,60
140	160	0,075-0,100	1,20-1,60	1,30-1,70	3,00-4,00	3,10-4,20
160	180	0,080-0,110	1,30-1,70	1,40-1,90	3,20-4,20	3,30-4,60
180	200	0,090-0,130	1,40-2,00	1,50-2,20	3,50-4,50	3,60-5,00
200	225	0,100-0,140	1,60-2,20	1,70-2,40	4,00-5,50	4,20-5,70
225	250	0,110-0,150	1,70-2,40	1,80-2,60	4,20-6,20	4,60-6,20
250	280	0,120-0,170	1,90-2,60	2,00-2,90	4,70-6,70	4,80-6,90
280	315	0,130-0,190	2,00-3,22	2,20-3,20	5,00-7,50	5,20-7,70
315	355	0,150-0,210	2,40-3,40	2,60-3,60	6,00-8,20	6,20-8,40
355	400	0,160-0,215	2,60-3,60	2,90-3,90	6,50-9,00	6,80-9,20
400	450	0,170-0,230	3,10-4,10	3,40-4,40	7,70-10,0	7,00-10,4
450	500	0,200-0,260	3,30-4,40	3,60-4,80	8,20-11,0	8,40-11,2
500	560	0,210-0,280	3,70-5,00	4,10-5,40	9,20-12,5	9,60-12,8
560	630	0,240-0,320	4,00-5,40	4,40-5,90	10,0-13,5	10,4-14,0
630	710	0,260-0,350	4,60-6,20	5,10-6,80	11,5-15,5	12,0-16,0
710	800	0,340-0,450	5,30-7,00	5,80-7,60	13,3-17,5	13,6-18,0
800	900	0,370-0,500	5,70-7,80	6,30-8,40	14,3-19,5	14,8-20,0
900	1000	0,410-0,550	6,30-8,50	7,00-9,40	15,8-21,0	16,4-22,0
1000	1120	0,450-0,600	6,80-9,00	7,60-10,2	17,0-23,0	18,8-24,0
1120	1250	0,490-0,650	7,40-9,80	8,30-11,0	18,5-25,0	19,6-26,0
1250	1400	0,550-0,720	8,30-10,8	9,30-12,1	21,0-27,0	22,2-28,3

5.2.10 AXIAL BEARINGS MOUNTING

The axial bearings shaft rings have usually a displacement housing and body rings have always a clearance housing. The shaft ring must be axially held in at two-way axial bearings (see Figure 54 and 55). The prestress set up is the same as tapered roller bearings. The axial bearing with running high-turns must be constantly prestressed to ensure correct rolling bodies rolling away. The prestress is reached by a nut (Figure 54) or by a grooved pad (see Figure 55), eventually by springs.

Figure 54

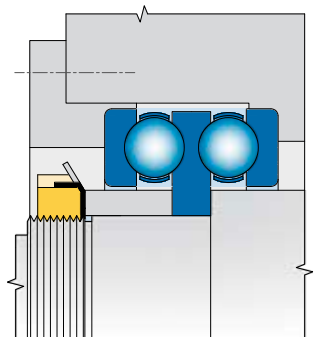
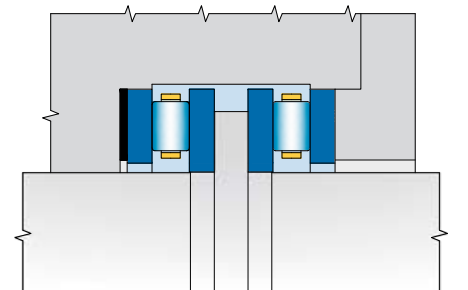

Figure 55



5.2.11 MOUNTING OF SINGLE ROW BALL BEARINGS WITH BALL SURFACE AND WIDER INNER RING (INSERT BALL BEARINGS)

If the shaft is produced within specified tolerance this must be checked out before mounting. In case that bodies are not delivered as a bearing unit, it means not together with mounting bearings, bearings will be mounted into bodies. The position of the lubricating up hole with the lubricating up groove in the body hole must be kept at the same time. This way the whole unit is ready for mounting onto the shaft. Bearings are secured on the shaft only after fixing the body to the supportive area.

5.3 ROLLING BEARINGS DISMOUNTING

5.3.1 Method selection of dismounting

Bearing fixing	Dismounting method	Dismounting equipment
Roller pivot		
Small bearing	mechanically	nut runner
Medium bearing	mechanically hydraulically thermally	nut runner, hydraulic equipment, inductive equipment, heating up ringlet
Large bearing	hydraulically thermally	hydraulic equipment, inductive equipment, heating up ringlet
Conical pivot		
Small bearing	mechanically hydraulically	nut runner, hydraulic equipment
Medium bearing	hydraulically	hydraulic equipment
Large bearing	hydraulically	hydraulic equipment
Clamping case		
Small bearing	mechanically hydraulically	bar, hammer hydraulic equipment
Medium bearing	mechanically hydraulically	bar, hammer, mechanic press hydraulic equipment
Large bearing	hydraulically	hydraulic equipment
Tightening case		
Small bearing	mechanically hydraulically	clamping nut hydraulic equipment
Medium bearing	mechanically hydraulically	clamping nut hydraulic equipment
Large bearing	hydraulically	hydraulic equipment

Small bearing: hole diameter < 75 mm

Medium bearing: hole diameter 75 to 200 mm

Large bearing: hole diameter >200 mm

5.3.2 MECHANICAL METHODS

5.3.2.1 Roller hole bearings dismounting

Bearings and housing connecting components must be dismounted by the proper equipment in a dry and dust-free workplace, not to be damaged and possibly to be used again. The dismounting jig should only lean against the ring which is just dismounted. The force necessary for dismounting cannot be carried through the rolling bodies, since the functional bearings areas would be damaged. The ring with the sliding housing is first dismounted at the bearings which cannot be taken apart (see Figure 56).

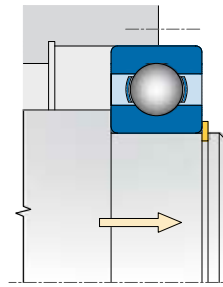

Figure 56

The bigger force is usually necessary for tightening of the bearing ring with the solid housing, then for pressing when the mounting bearing surface is solid. Rings can be dismounted separately at bearings which can be taken apart (see Figure 57).

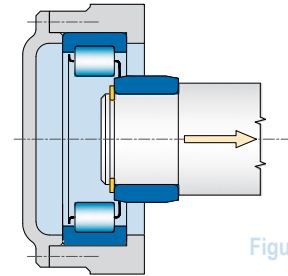

Figure 57

The mechanical nut runner or hydraulic press with the tightening force acting on the solid housing ring directly or through the supportive component, e.g. labyrinth ring, are mostly used for the small bearings tightening (see Figure 58).

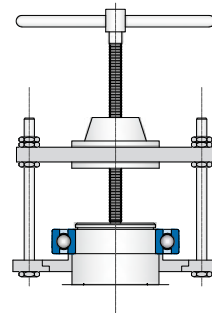

Figure 58

If at equipment construction were designated holes with the thread for dismounting pressing off screws or grooves for the nut runner which can be fixed directly to the bearing ring, then it makes the bearings dismounting easier (see Figure 60, 61).

The ball, tapered roller and cylindrical roller bearings can be dismounted by the special (tie) nut runners when the inner ring wholly adheres to the shaft collar without grooves for the nut runner. Also bearings still built-in the body can be tighten on the pivot by this nut runner.

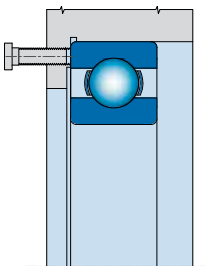

Figure 59

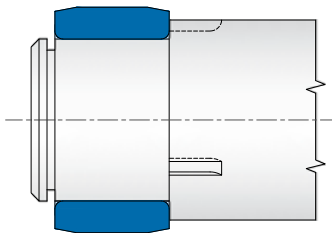

Figure 60

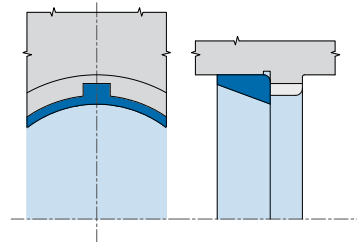

Figure 61

5.3.2.2 Dismounting of bearings with tapered bore

First the nut is partially loosened and the inner ring released from the pivot conical housing areas or from clamping case by light hammer hits during dismounting of bearings with the direct pivot conical housing. The softer metal stick is used for this (see Figure 62). The jig will lean against the nut or directly against the clamping case, if the press is used at dismounting (see Figure 63).

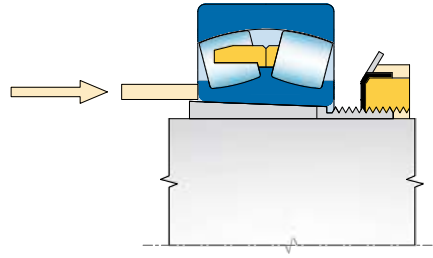

Figure 62

Bearings fixed to the pivot by the clamping case are dismounted by the tightening nut (see Figure 64). The forcing off screws nut is used in more complicated cases and at bigger bearings (see Figure 65). The pad is put in between the forcing off screws and the front of the inner ring. Dismounting of tightening cases by the hydraulic nut is simpler (see Figure 66). Tightening cases stretching over the shaft end are supported by the thick-wall ring in the hole.

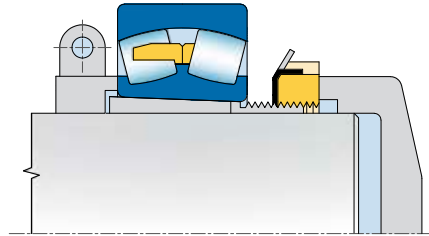

Figure 63

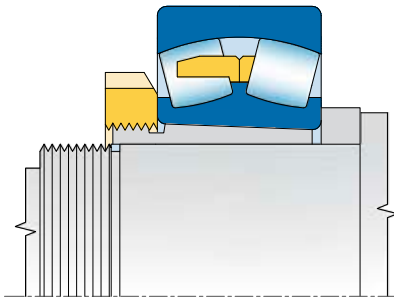

Figure 64

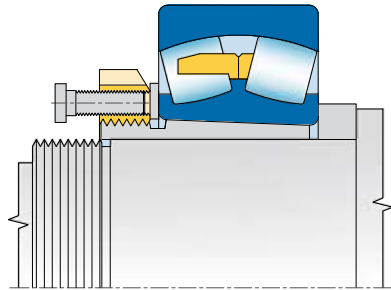

Figure 65

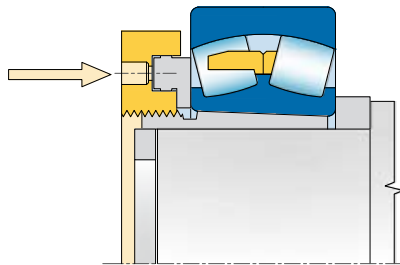

Figure 66

5.3.3 THERMAL METHODS OF BEARINGS DISMOUNTING

5.3.3.1 Heating up ring

The heating up ring (see Figure 67) is proper for dismounting of the cylindrical roller bearings inner rings. The ring is made of aluminium alloy and has a radial slot. Handling of the ring is enabled by thermally isolated holders. The ring has the same width as the bearing and bore has the same diameter as the rotary track of the bearing inner ring.

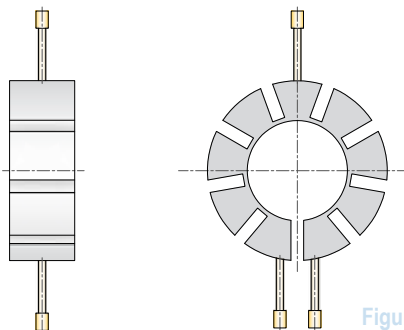

Figure 67

The ring is heated up from 200 to 300°C on the electric heating board, it is inserted on the tightened inner ring coated by the thick oxid-proof oil, and then it is held by holders. The heat very quickly passes from the ring into the inner bearing ring. The ring together with the ringlet are tightened after the shaft housing overlap release. The ringlet is proper for the medium size bearings rings tightening. The proper heating up ringlet must be chosen for each different bearing size.

5.3.3.2 Inductive dismounting equipment

The inductive dismounting equipment is first of all used for tightening inner rings of the cylindrical roller and needle roller bearings with the bore diameter from 100 mm when bearings are solidly fixed on the shaft. Heating up takes place so quickly that only a little heat penetrates into the shaft, while rings easily release. The rings are heated from the 80 to 100°C temperature.

5.3.3.3 Circular burner

The inner rings of bigger takable apart bearings can be heated up also by flame if there are not grooves and hydraulic mounting channels on the shaft. The circular burner held good in such cases. The distance between the pipes and ring surface should be from 40 to 50 mm. The burner holes have the diameter 2 mm, they are alternately moved away with the spacing from 18 to 24 mm, at usual gas pressure. The burner must be co-axial with the bearing ring at heating and during heating it is slowly and evenly moved the axial direction over the bearing ring surface.

5.3.4 HYDRAULIC METHOD AT BEARING MOUNTING

The oil is pressed in between the contact areas during the hydraulic method. The oil film breaks contact between components which can be mutually moved away by relatively small force and without dangerous surface damaging. The hydraulic method is equally proper for dismounting of connections of the conical and roller contact areas. Grooves, feed channels and connecting threads must be produced in the pivot in both cases to attach the oil pressure source (see Figure 68).

Bigger tightening and clamping cases are produced with grooves and channels for pressure oil. Approximately 45 mm².s⁻¹ viscosity oil at 40°C can be used for dismounting. Approximately 300 mm².s⁻¹ viscosity transmission oil at 40°C is used when the contact areas are damaged.

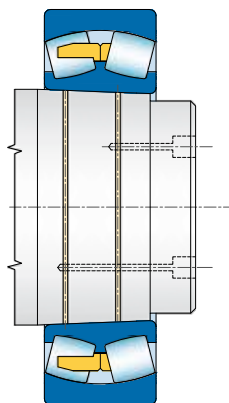

Figure 68

5.3.4.1 Dismounting of bearings with cylindrical bore

The hydraulic method is usually used only during dismounting at the cylindrical bore bearings. The tightening jig is used at dismounting (see Figure 69).

The oil is forced into both of oil channels by two pumps after inserting the jig. After the oil penetrated in between the roller areas and rings were released, the ring is tightened by the jig so far away that equally covers the front groove on both sides. The oil feed is interrupted at this position. The spring is inserted into the leading case of the tightening jig and is prestretched. The spring deflection must be bigger than the length by which the ring is put on the shaft. The spring prestress should be approximately $P=20 \cdot d$ (N). The inner ring is tightened by the spring force after pressing oil into the front channel. The oil can be pressed in between the contact areas from the front of the inner ring, when there are no oil grooves or feed channels in the pivot.

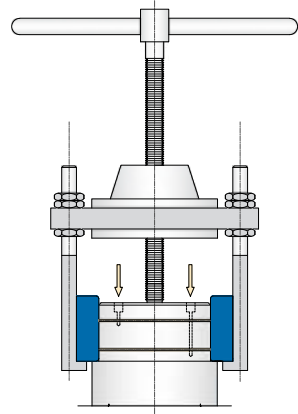

Figure 69

The sealed ring forcing oil in between the contact areas is pushed against the front side of the pressed bearing. The oil is forced in between the contact areas, until the end of the tightening process, by the special case fixed to the pivot front. $300 \text{ mm}^2 \cdot \text{s}^{-1}$ viscosity oil at 40°C must be used if the special case cannot be used. Such oil between the contact areas creates a film kept up 4 to 7 minutes. This time is enough for the bearing tightening. The tightening cases are relatively expensive and are used only in such situations when it is necessary often dismount bigger quantity of bearings (e.g. at track vehicles axle). The inductive heating up is more proper to use mainly at usual maintenance during bearings dismounting.

5.3.4.2 Dismounting of bearings with tapered bore

To force the oil in between the contact areas is enough at tightening of bearings with the direct housing on the conical pivot or on the tightening and clamping case. It is necessary to proceed carefully at this work, since the connection will loosen at once. The axial bearing or case jumping aside during dismounting must be limited by the nut on the shaft (see Figure 70) or on the case (see Figure 71) respectively by stop (see Figure 72), considering danger of an accident.

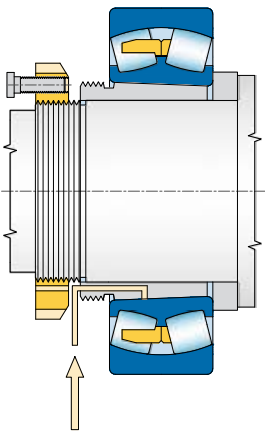

Figure 70

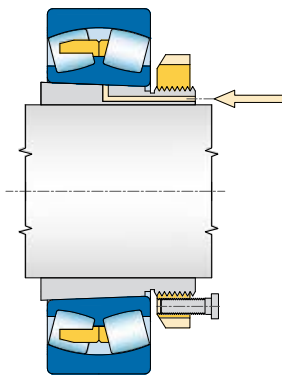

Figure 71

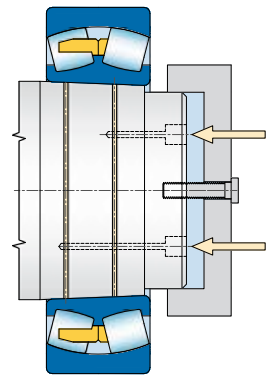

Figure 72

The pulling clamping case out can be supported by the tightening nut, screwed onto the case in more complicated cases. If such a nut has forcing off screws (see Figure 73), the pad is put under the screws, preventing the direct effect of the screws pressure on the bearing ring collar.

If the bearing leans against the supportive ringlet, the tightening case can also be loosened by the hydraulic nut. The hydraulic nut must lean against the terminal board (see Figure 74).

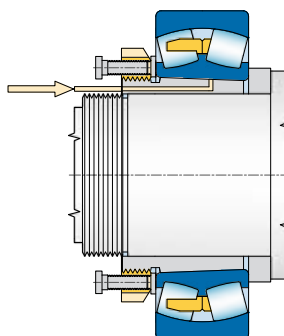

Figure 73

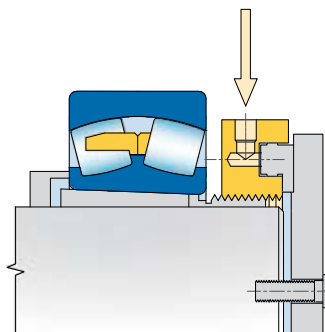
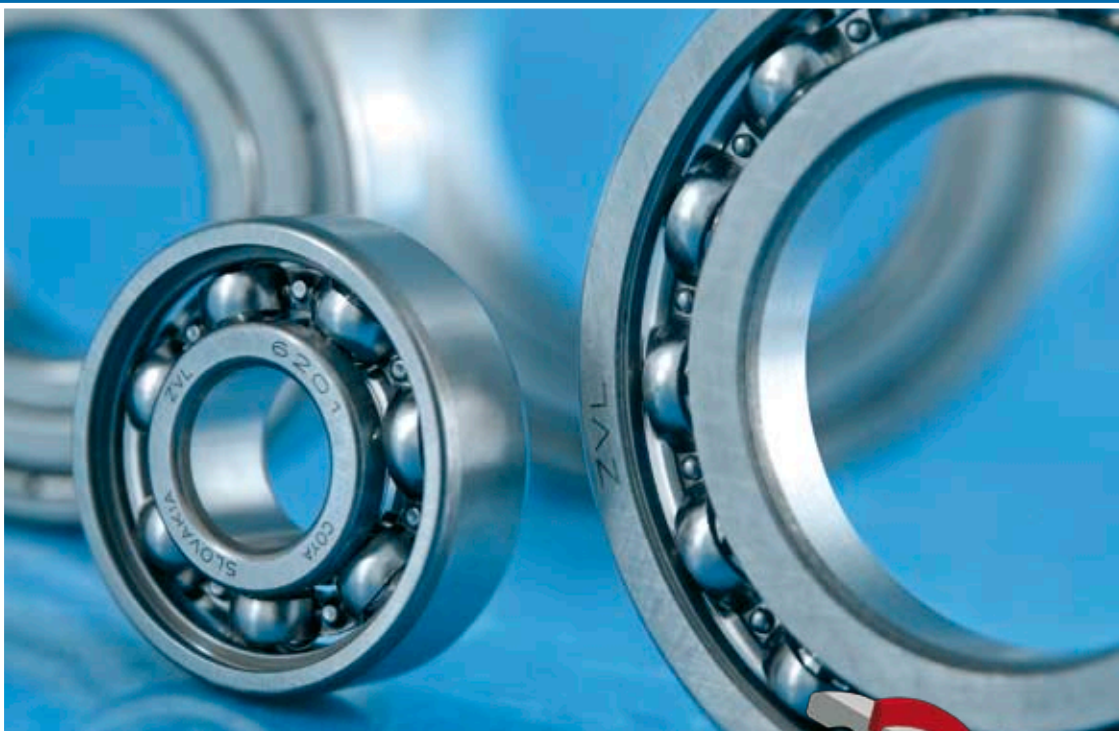

Figure 74



SINGLE ROW DEEP GROOVE BALL BEARINGS



SINGLE ROW DEEP GROOVE BALL BEARINGS

The single row deep groove ball bearings have relatively deep raceways on both rings without a filling slot and they are non-separable. By optimum size of balls and by their conformity to the raceways high load ratings are achieved.

They can carry axial and radial loads in both directions and are suitable even for high rotation speeds. These bearings are manufactured in a broad selection of types and are the most common rolling bearing type.



DESIGN SPECIFICATIONS

MAIN DIMENSIONS

Main dimensions of single row deep groove ball bearings specified in the dimension tables are in accordance with the international standards ISO 15. Snap ring groove dimensions comply with the international standards ISO 464.

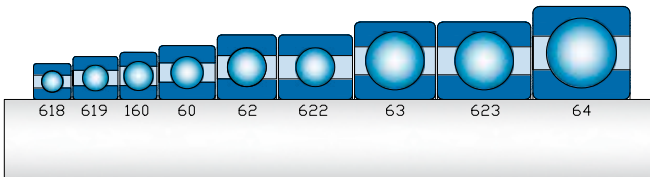

BEARINGS WITH SHIELDS OR SEALS

Single row deep groove ball bearings with sealing on one or on both sides are manufactured with metal shields (Z, -ZZ, or ZR, -ZZR) or with seals (RS, -2RS or RSR, -2RSR).

The shields create a non-contact sealing.

The bearings are manufactured in the original design with shoulders for shields on the inner ring (Z, -ZZ) or in the new design with a shield and a flat collar of the inner ring (ZR, -ZZR).

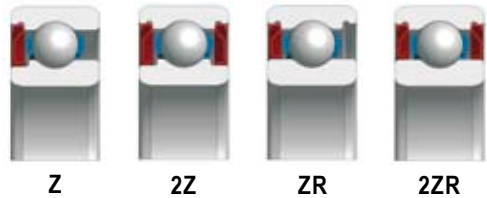

The sealing rings made of rubber, vulcanized on metal reinforcing ring, provide an effective friction type sealing. The bearings are manufactured in the design with rounded shoulders on the inner ring (RS, -2RS) or in a new design with a seal and a flat collar of the inner ring (RSR, -2RSR). Bearings with seals are suitable for usage within the temperature range from -30 °C to 110 °C. Delivery of bearings with seals within the operating temperature range from -40 °C to 250 °C (RS2, -2RS2 or RSR2, -2RSR2) should be discussed in advance. Shields and seals are inserted in the recess of the outer ring and these are not removable.

Bearings sealed on both sides (-ZZ, -2RS, or -ZZR, -2RSR) are filled with a quality grease the properties of which usually ensure the lubrication during the whole bearing life under normal operating conditions. The bearings of this design cannot be relubricated. They can be used within the operating temperature range from -30 °C to 110 °C. The delivery of bearings with different grease should be discussed with the supplier in advance.

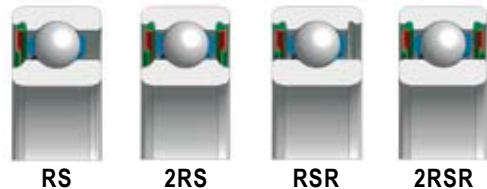

GREASE

For bearings sealed on both sides, the designation of the grease filling different from standard grease is indicated by a symbol combination. The first two letters indicate the operating temperature range (a symbol in accordance with STN 02 4608) and the third identifies the grease name.

- TL** - Grease for low operating temperatures (from -60 °C to 100 °C)
- TM** - Grease for medium operating temperatures (from -35 °C to 140 °C)
- TH** - Grease for high operating temperatures (from -30 °C to 200 °C)
- TW** - Grease for low and high operating temperatures (from -40 °C to 150 °C)

Note: The symbols of greases for medium operating temperatures need not to be marked on the bearings.



BEARINGS WITH SNAP RING GROOVE

The single row deep groove ball bearings with a snap ring groove (N) can be easily axially fixed in the housings and without high requirements on the space simplifying the arrangement design. For bearings with a groove in the outer ring, snap rings corresponding to STN 02 4605 are used (commercial designation R and the number indicating the outside diameter D of the corresponding bearing, e. g. R47). Bearings with a snap ring groove and a snap ring are designated by the suffix NR, e. g. 6204NR. Snap rings for the bearings with a snap ring groove are delivered separately. The bearings with a snap ring groove can also be delivered in the modification with shields or seals (ZN, -2ZN or RSN, -2RSN). The delivery of these bearings must be discussed in advance.

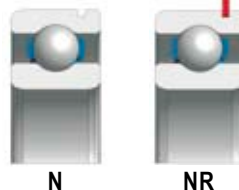

TAPERED BORE

For some less demanding arrangements, e. g. in agricultural machines, etc., some sizes of single row deep groove ball bearings of type 62 and 63 with a tapered bore (K), taper 1:12 are manufactured. These bearings are also manufactured in a design with shields on both sides. The bearings are fixed on the cylindrical shaft by means of adapter sleeves of types H2, H3 or directly on the tapered shaft.

CAGE

The single row deep groove ball bearings of the basic design are equipped with a pressed cage made of steel sheet, guided on balls, which is not designated. In special cases the bearings are produced with different types of cages: bearings with a solid polyamide cage (TNH, TNGH), with a solid cage of textite (TB). The supply of these bearings should be discussed in advance.

TOLERANCES

Single row deep groove ball bearings are produced in tolerance classes P0 and P6. For special arrangements requiring high precision or for arrangements with a high rotation speed, the bearings in higher tolerance classes P5 and P4 are used. The bearings in higher tolerance class P6E are used for rotating electric machines. The limit values of deviations in tolerances and the operation are specified in ISO 492.

RADIAL CLEARANCE

Commonly produced single row deep groove ball bearings have normal radial clearance which is not indicated. In specific cases bearings with radial clearance C2 (smaller than normal clearance) or with the radial clearance C3, C4, C5 (greater than normal clearance) can be produced (ISO 5753).

VIBRATION LEVEL

Commonly manufactured single row ball bearings have a normal vibration level checked by the manufacturer. For special arrangements bearings with reduced vibration level (C6) are produced.

COMBINATION OF SYMBOLS

The symbols for the tolerance classes, internal bearing clearances and vibration levels are combined with the simultaneous omission of the symbol C for the second and the following special bearing characteristics e. g.:

P6 + C3 = P63	6202 P63
C3 + C6 = C36	6305-2RS C36
P6 + C3 + C6 = P636	6204-2Z P636

STABILISATION FOR OPERATION AT HIGHER TEMPERATURE

For operating temperature higher than 120 °C specially stabilized single row deep groove ball bearings with stabilized dimensions for operating temperature from 150 °C to 400 °C (S0, S1, S2, S3, S4,S5) are produced. Delivery of stabilized bearings should be discussed in advance.

MISALIGNMENT

For single row ball bearings only small mutual misalignment of bearing rings is permissible, therefore alignment deviation of seating surfaces can be very small. Misalignment causes additional load of the bearing and thus its life is shortened. Values of permissible misalignment at normal operating conditions are shown in the table.

BEARING TYPE	LOAD	
	HEAVY ($F_{ra} \geq 0,15 C_{or}$)	LIGHT ($F_r < 0,15 C_{or}$)
618,619,160,60	2' to 6'	5' to 10'
62,63,64	5' to 10'	8' to 16'

RADIAL EQUIVALENT DYNAMIC LOAD

Single row deep groove ball bearings:

$$P_r = F_r \quad \text{for } F_a/F_r \leq e$$

$$P_r = 0,56 F_r + YF_a \quad \text{for } F_a/F_r > e$$

Factors

F_d/C_{or}	e	Y
0.025	0.22	2
0.040	0.24	1.8
0.070	0.27	1.6
0.130	0.31	1.4
0.250	0.37	1.2
0.500	0.44	1

Factor Y values are valid, if the bearings on the journal and in the housing will be fitted in tolerances recommended for small and medium loads and during operation significant reduction of radial clearance due to operating temperature does not come into being (temperatures difference between inner and outer ring max 10 °C).

RADIAL EQUIVALENT STATIC LOAD

Single row deep groove ball bearings:

$$P_{or} = 0,6 F_r + 0,5 F_a \quad \text{for } (P_{or} \geq F_r)$$



DESIGNATION

The designation of basic designs and common modifications of the bearings are specified in the dimension tables. Modification of the basic design is designated with additional symbols according to STN 02 4608. The meaning of the most used symbols for single row deep groove ball bearings is in the table.

SYMBOL	EXAMPLE OF DESIGNATION	MEANING
RS	6009RS	Seal on one side
RSR	6205RSR	Seal on one side adhering to flat surface of inner ring
-2RSR	6212-2RSR	Seal on both sides adhering to flat surface of inner ring
Z	6206Z	Metal shield on one side
ZN	6305ZN	Metal shield on one side and snap ring groove in outer ring opposite to metal shield
-2Z	6308-2Z	Metal shield on both sides
-2ZR	6005-2ZR	Metal shields on both sides adhering to flat surface of inner ring
K	6204-2ZK	Tapered bore, taper 1:12
N	6407N	Snap ring groove in outer ring
NR	6307NR	Snap ring groove in outer ring and inserted snap ring
TNH	6207TNH	Plastic cage guided on balls
TB	6210TB	Machined cage made of textite guided on the inner ring
P6	6205 P6	Higher tolerance class than standard
P6E	6204-2Z P6E	Higher tolerance class for rotating electric machines
P5	6203 P5	Higher tolerance class than P6
P4	6004 P4	Higher tolerance class than P5
C2	6213 C2	Radial clearance less than normal
C3	6305-2ZR C3	Radial clearance greater than normal
C4	6007-2RS C4	Radial clearance greater than C3
C5	6302-2ZR C5	Radial clearance greater than C4
C6	6315 C6	Reduced vibration level
R...	6211 R10-20	Radial clearance in non-standardized range
SO	6205 SO	Stabilisation for operating temperature to 150 °C
S1	6304 S1	Stabilisation for operating temperature to 200 °C
S2	6302-2ZR CSS2	Stabilisation for operating temperature to 250 °C
S3	6310-2ZR CSS3	Stabilisation for operating temperature to 300 °C
S4	6306-2ZR CSS4	Stabilisation for operating temperature to 350 °C
S5	6309-2ZR CSS5	Stabilisation for operating temperature to 400 °C
TP	6205-2Z P6E TP	Bearings produced according to special technical conditions agreed with the customer



SINGLE ROW DEEP GROOVE BALL BEARINGS ZVL SLOVAKIA, a. s.

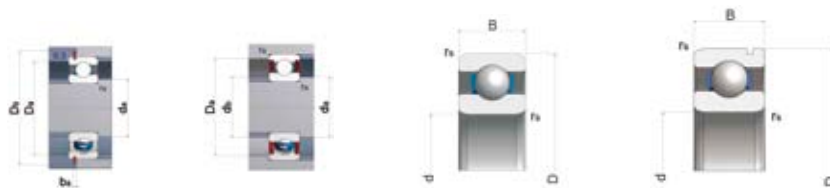

SINGLE ROW DEEP GROOVE BALL BEARINGS/SINGLE ROW DEEP GROOVE BALL BEARINGS WITH SHIELD AND SEAL/SINGLE ROW DEEP GROOVE BALL BEARINGS WITH SNAP RING GROOVE																		
DIMENSIONS mm			BASIC LOAD RATING kN		LIMITING SPEED FOR LUBRICATION WITH min-1				BEARING DESIGNATION					ABUTMENT AND FILLET DIMENSIONS			WEIGHT	
d	D	B	rs min	C	Co	Z, ZR	RS, SR	Standard	Z, ZR	2Z, 2ZR	RS, RSR	2RS, 2RSR	N	da max.	Da max.	ra max.	kg	
10	19	5	0,3	1,08	0,63	32 000	21 000	38 000	61800		61800-2ZR		61800-2RSR	12	17	0,3	0,005	
	22	6	0,3	1,95	0,75	34 000	22 000	40 000	61900		61900-2ZR		61900-2RSR	12	20	0,3	0,01	
	26	8	0,3	3,91	1,96	28 000	19 000	33 000	6000	6000ZR	6000-2ZR	6000RSR	6000-2RSR	12	24	0,3	0,02	
	30	9	0,6	5,11	2,51	25 000	17 000	30 000	6200	6200ZR	6200-2ZR	6200RSR	6200-2RSR	14	26	0,6	0,032	
	35	11	0,6	6,81	3,41	22 000	15 000	27 000	6300	6300ZR	6300-2ZR	6300RSR	6300-2RSR	14	31	0,6	0,053	
12	21	5	0,3	1,12	0,71	30 000	20 000	38 000	61801		61801-2ZR		61801-2RSR	14	19	0,3	0,006	
	24	6	0,3	2,25	0,98	30 000	20 000	36 000	61901		61901-2ZR		61901-2RS	14	22	0,6	0,11	
	28	7	0,3	4,5	2,37	25 000		30 000	6001					14	26	0,3	0,02	
	28	8	0,3	4,5	2,37	25 000	17 000	30 000	6001	6001ZR	6001-2ZR	6001RSR	6001-2RSR	14	26	0,3	0,022	
	32	10	0,6	6,1	3,1	22 000	15 000	27 000	6201	6201ZR	6201-2ZR	6201RSR	6201-2RSR	16	28	0,6	0,037	
15	37	12	1	8,58	4,22	20 000	13 000	24 000	6301	6301ZR	6301-2ZR	6301RSR	6301-2RSR	17	32	1	0,06	
	24	5	0,3	1,22	0,78	28 000	19 000	34 000	61802		61802-2ZR		61802-2RSR	17	22	3	0,045	
	28	7	0,3	4,03	2,04	24 000	17 000	30 000	61902		61902-2ZR		61902-2RSR	17	26	0,3	0,16	
	32	8	0,3	5,21	2,82	21 000		25 000	6002					17	30	0,3	0,027	
	32	9	0,3	5,21	2,82	21 000	14 000	25 000	6002	6002ZR	6002-2ZR	6002RSR	6002-2RSR	17	30	0,3	0,031	
17	35	11	0,6	7,1	3,76	20 000	13 000	24 000	6202	6202ZR	6202-2ZR	6202RSR	6202-2RSR	19	31	0,6	0,045	
	42	13	1	10,4	5,41	18 000	12 000	21 000	6302	6302ZR	6302-2ZR	6302RSR	6302-2RSR	20	36	1	0,082	
	25	5	0,3	1,32	0,91	24 000	17 000	30 000	61803		61803-2ZR		61803-2RSR	19	24	0,3	0,08	
	30	7	0,3	4,36	2,32	22 000	15 000	28 000	61903		61903-2ZR		61903-2RSR	19	28	0,3	0,18	
	35	8	0,3	5,73	3,22	20 000		24 000	6003					19	33	0,3	0,032	
20	35	10	0,3	5,73	3,22	20 000	13 000	24 000	6003	6003ZR	6003-2ZR	6003RSR	6003-2RSR	19	33	0,3	0,04	
	40	12	0,6	9,26	4,82	18 000	12 000	21 000	6203	6203ZR	6203-2ZR	6203RSR	6203-2RSR	6203N	21	36	0,6	0,065
	47	14	1	13,1	6,56	16 000	10 600	19 000	6303	6303ZR	6303-2ZR	6303RSR	6303-2RSR	6303N	23	41	1	0,116
	62	17	1,1	22	10,8	12 600		15 000	6403					23,5	55,5	1	0,265	
	32	7	0,3	2,04	1,4	19 000	12 000	24 000	61804		61804-2ZR		61804-2RSR	22	30	0,3	0,018	
25	37	9	0,3	6,37	3,65	18 000	12 000	22 000	61904		61904-2ZR		61904-2RSR	22	35	0,3	0,038	
	42	8	0,3	6,7	3,97	17 000		20 000	6004					22	40	0,3	0,05	
	42	12	0,6	9,44	5,01	17 000	11 000	20 000	6004	6004ZR	6004-2ZR	6004RSR	6004-2RSR	24	38	0,6	0,07	
	47	14	1	12,8	6,56	15 000	10 000	18 000	6204	6204ZR	6204-2ZR	6204RSR	6204-2RSR	6204N	25	42	1	0,107
	52	15	1,1	16	7,94	14 000	9 400	17 000	6304	6304ZR	6304-2ZR	6304RSR	6304-2RSR	6304N	26	45	1	0,144
30	72	19	1,1	31	15	11 000		13 000	6404					6404N	27	33	1	0,398
	37	7	0,3	2,28	1,7	17 000	11 000	20 000	61805		61805-2ZR		61805-2RSR	27	35	0,3	0,022	
	42	9	0,3	6,6	2,6	17 000	11 000	20 000	61905		61905-2ZR		61905-2RSR	27	40	0,3	0,044	
	47	8	0,3	6,95	4,6	14 000		17 000	6005					27	43	0,3	0,053	
	47	12	0,6	10	5,84	14 000	9 400	17 000	6005	6005ZR	6005-2ZR	6005RSR	6005-2RSR	28	43	0,6	0,081	
30	52	15	1	14,1	7,94	12 600	8 400	15 000	6205	6205ZR	6205-2ZR	6205RSR	6205-2RSR	6205N	30	47	1	0,128
	62	17	1,1	20,7	11,2	11 000	7 500	13 000	6305	6305ZR	6305-2ZR	6305RSR	6305-2RSR	6305N	31	55	1	0,232
	80	21	1,5	36	19,2	9 400		11 000	6405					6405N	34	70	1,5	0,53
	42	7	0,3	2,28	1,8	15 000	8 500	18 000	61806		61806-2ZR		61806-2RSR	32	70	0,3	0,026	
	47	9	0,3	7,2	4,5	14 000	10 500	17 000	61906		61906-2ZR		61906-2RSR	32	45	0,3	0,05	
30	55	9	0,3	11,2	7,36	12 000		14 000	6006					32	53	0,3	0,087	
	55	13	1	13,3	8,25	12 000	7 900	14 000	6006	6006ZR	6006-2ZR	6006RSR	6006-2RSR	6006N	34	50	1	0,119
	62	16	1	19,6	11,2	11 000	7 500	13 000	6206	6206ZR	6206-2ZR	6206RSR	6206-2RSR	6206N	35	57	1	0,201
	72	19	0,1	30	15,8	10 000	6 700	12 000	6306	6306ZR/Z	6306-2ZR/2Z	6306RSR/RS	6306-2RSR/2RS	6306N	36	65	1	0,35
	90	23	1,1	43	23,7	8 400		10 000	6406					6406N	39	80	1,5	0,725

SINGLE ROW DEEP GROOVE BALL BEARINGS ZVL SLOVAKIA, a. s.

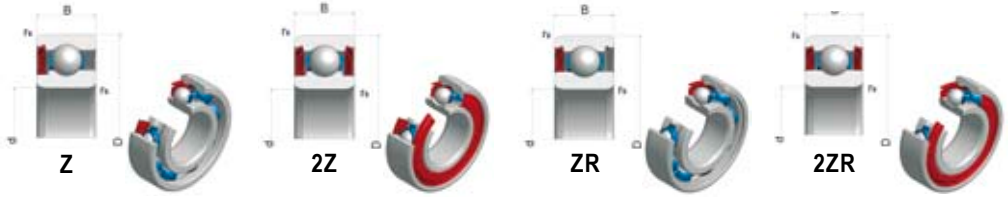

SINGLE ROW DEEP GROOVE BALL BEARINGS/SINGLE ROW DEEP GROOVE BALL BEARINGS WITH SHIELD AND SEAL/SINGLE ROW DEEP GROOVE BALL BEARINGS WITH SNAP RING GROOVE																		
DIMENSIONS mm				BASIC LOAD RATING kN		LIMITING SPEED FOR LUBRICATION WITH min ⁻¹				BEARING DESIGNATION					ABUTMENT AND FILLET DIMENSIONS			WEIGHT kg
d	D	B	rs min	C	Co	Z, ZR	RS, SR	Standard	BEARING DESIGNATION					da max.	Da max.	ra max.	kg	
									Z, ZR	ZZ, ZZR	RS, RSR	2RS, 2RSR	N					
35	47	7	0,3	2,35	2	13 000	8 200	16 000	61807						37	45	0,3	0,03
	55	10	0,6	9,5	6,15	11 000	6 800	14 000	61907						39	51	0,6	
	62	9	0,3	12,3	8,74	10 600		12 600	16007						37	60	0,3	0,111
	62	14	1	16	10,2	10 600	7 100	12 600	6007	6007ZR	6007ZZR	6007RSR	6007ZRSR	6007N	39,5	57	1	0,159
	72	17	1,1	25,6	15,3	9 400	6 300	11 000	6207	6207ZR/Z	6207ZZR/ZZ	6207RSR/RS	6207ZRSR/ZRS	6207N	42	65	1	0,29
	80	21	1,5	33,5	19,2	8 400	5 600	10 000	6307	6307ZR/Z	6307ZZR/ZZ	6307RSR/RS	6307ZRSR/ZRS	6307N	42	71	1,5	0,46
40	100	25	1,5	55,2	31	7 500		8 900	6407						44	90	1,5	0,954
	52	7	0,3	2,45	2,2	11 000	7 000	14 000	61808						42	50	0,3	0,033
	62	12	0,6	13,8	9,3	10 000	6 900	13 000	61908						44	58	0,6	0,12
	68	9	0,3	13,2	10,2	9 400		11 000	16008						42	62	0,3	0,125
	68	15	1	16,8	11,4	9 400	6 300	11 000	6008	6008ZR	6008ZZR	6008RSR	6008ZRSR	6008N	44	63	1	0,195
	80	18	1,1	32,9	20	8 400	5 600	10 000	6208	6208ZR/Z	6208ZZR/ZZ	6208RSR	6208ZRSR	6208N	47	73	1	0,367
45	90	23	1,5	40,6	23,7	7 900	5 300	9 400	6308	6308ZR	6308ZZR	6308RSR	6308ZRSR	6308N	47	81	1,5	0,635
	110	27	2	63,1	36,2	6 700		7 900	6408						50	97	2	1,23
	58	7	0,3	4,65	3,8	9 500	6 400	12 000	61809						47	56	0,3	0,04
	68	12	0,6	14	9,6	9 000	6 100	11 000	61909						49	64	0,6	0,14
	75	10	0,6	15,6	12,1	8 400		10 000	16009						49	71	1	0,17
	75	16	1	21,1	15,3	8 400	5 600	10 000	6009	6009ZR	6009ZZR	6009RSR	6009ZRSR	6009N	49	70	1	0,249
50	85	19	1,1	32,9	20,3	7 900	5 300	9 400	6209	6209ZR	6209ZZR	6209RSR	6209ZRSR	6209N	52	78	1	0,41
	100	25	1,5	53,1	31,6	7 100	4 700	8 400	6309	6309ZR	6309ZZR	6309RSR	6309ZRSR	6309N	52	91	1,5	0,833
	120	29	2	76,5	44,7	6 000		7 100	6409						55	107	2	1,54
	65	7	0,3	4,8	4,24	9 000	5 800	11 000	61810						52	63	0,3	0,051
	72	12	0,6	14,6	10,35	8 500	5 500	10 000	61910						54	68	0,6	0,14
	80	10	0,6	16,2	13,1	7 900		9 400	16010						54	76	0,6	0,188
55	80	16	1	22	16,5	7 900	5 300	9 400	6010	6010ZR	6010ZZR	6010RSR	6010ZRSR	6010N	54	75	1	0,264
	90	20	1,1	34,8	23,3	7 100	4 700	8 400	6210	6210ZR/Z	6210ZZR/ZZ	6210RSR/RS	6210ZRSR/ZRS	6210N	57	83	1	0,464
	110	27	2	61,9	37,6	6 300	4 200	7 500	6310	6310ZR	6310ZZR	6310RSR	6310ZRSR	6310N	60	100	2	1,08
	130	31	2,1	87,4	52,1	5 600		6 700	6410						63	116	2	1,89
	72	9	0,3	6,4	5,6	8 500	5 500	10 000	61811						57	70	0,3	0,082
	80	13	1	15,9	11,4	8 000	5 100	9 000	61911						60	75	0,6	0,19
60	90	11	0,6	19,3	16,2	7 100		8 400	16011						59	86	0,6	0,26
	90	18	1,1	28,2	21,1	7 100	4 700	8 400	6011	6011ZR	6011ZZR	6011RSR	6011ZRSR	6011N	60	84	1	0,39
	100	21	1,5	43	29,3	6 700	4 500	7 900	6211	6211ZR	6211ZZR	6211RSR	6211ZRSR	6211N	62	91	1,5	0,611
	120	29	2	71	44,7	5 600	3 800	6 700	6311	6311ZR	6311ZZR	6311RSR	6311ZRSR	6311N	65	110	2	1,38
	140	33	2,1	100	61,9	5 300		6 300	6411						68	126	2	2,29
	78	10	0,3	6,7	6,1	7 500	4 800	9 000	61812						62	76	0,3	0,11
65	85	13	1	16,5	12	7 500	4 800	9 000	61912						65	80	1	0,2
	95	11	0,6	20	17,4	6 700		7 900	16012						64	91	0,3	0,28
	95	18	1,1	29,3	23,3	6 700	4 500	7 900	6012	6012ZR	6012ZZR	6012RSR	6012ZRSR	6012N	65	88	1	0,42
	110	22	1,5	52,1	36,3	6 000	4 000	7 100	6212	6212ZR/Z	6212ZZR/ZZ	6212RSR/RS	6212ZRSR/ZRS	6212N	67	101	1,5	0,787
	130	31	2,1	81,5	52,1	5 300	3 500	6 300	6312	6312ZR	6312ZZR	6312RSR	6312ZRSR	6312N	72	118	2	1,72
	150	35	2,1	110	69,4	4 700		5 600	6412						73	136	2	2,76
70	85	10	0,6	9	8,3	7 000	4 700	8 500	61813						69	81	0,6	0,13
	90	13	1	17,4	13,4	6 700	4 600	8 000	61913						70	85	1	0,22
	100	11	0,6	21,2	19,6	6 300		7 500	16013						69	96	0,6	0,3
	100	18	1,1	30,5	25,1	6 300	4 200	7 500	6013	6013ZR	6013ZZR	6013RSR	6013ZRSR	6013N	70	93	1	0,44
	120	23	1,5	57,3	39,8	5 300	3 500	6 300	6213	6213ZR	6213ZZR	6213RSR	6213ZRSR	6213N	72	111	1,5	0,995
	140	33	2,1	92,6	59,6	5 000	3 300	6 000	6313	6313ZR	6313ZZR	6313RSR	6313ZRSR	6313N	76	128	2	2,1
75	160	37	2,1	119	77,9	4 500		5 300	6413						78	146	2	3,28
	90	10	0,6	9,3	9,15	6 700	4 500	8 000	61814						74	86	0,6	0,14
	100	16	1	23,8	18,3	6 300	4 300	7 500	61914						75	95	1	0,35
	110	13	0,6	27,6	25,1	5 600		6 700	16014						74	106	0,6	0,433
	110	20	1,1	38,3	31	5 600	3 800	7 000	6014	6014ZR	6014ZZR	6014RSR	6014ZRSR	6014N	75	103	1	0,618
	125	24	1,5	62	43,8	5 300	3 500	6 300	6214	6214ZR	6214ZZR	6214RSR	6214ZRSR	6214N	77	116	1,5	1,09
80	150	35	2,1	104	68,1	4 700	3 200	5 600	6314	6314ZR	6314ZZR	6314RSR	6314ZRSR	6314N	81	138	2	2,53
	180	42	3	144	104	4 000		4 700	6414						85	164	2,5	4,85



SINGLE ROW DEEP GROOVE BALL BEARINGS ZVL SLOVAKIA, a. s.

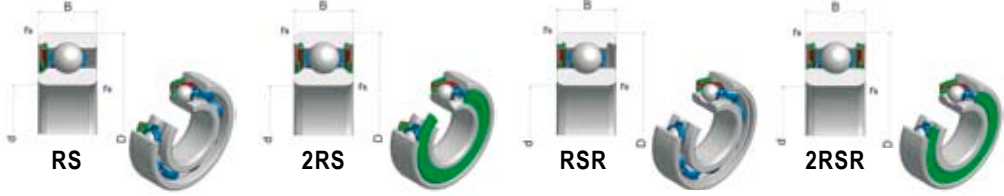

SINGLE ROW DEEP GROOVE BALL BEARINGS/SINGLE ROW DEEP GROOVE BALL BEARINGS WITH SHIELD AND SEAL/SINGLE ROW DEEP GROOVE BALL BEARINGS WITH SNAP RING GROOVE

DIMENSIONS mm		BASIC LOAD RATING kN		LIMITING SPEED FOR LUBRICATION WITH min ⁻¹			BEARING DESIGNATION					ABUTMENT AND FILLET DIMENSIONS			WEIGHT			
d	D	B	rs min	C	Co	Z, ZR	RS, SR	Standard	Z, ZR	2Z, 2ZR	RS, RSR	2RS, 2RSR	N	da max.	Da max.	ra max.		
75	95	10	0,6	9,65	9,8	6 300	4 300	7 500	61815		61815-2ZR		61815-2RSR		79	91	0,6	0,15
	105	16	1	24,2	19,3	6 000	4 100	7 000	61915		61915-2ZR		61915-2RSR		80	100	1	0,37
	115	13	0,6	28,7	26,6	5 300		6 300	16015					79	111	0,6	0,457	
	115	20	1,1	39,8	33,5	5 300	3 500	6 300	6015Z	6015-2ZR	6015RSR	6015-2RSR	6015N	80	108	1	0,64	
	130	25	1,5	66,8	49,2	5 000	3 300	6 000	6215Z	6215-2ZR	6215RSR	6215-2RSR	6215N	82	122	1,5	1,19	
	160	37	2,1	114	76,4	4 200	2 800	5 000	6315Z	6315-2ZR	6315RSR	6315-2RSR	6315N	86	148	2	3,03	
80	190	45	3	153	114	3 800		4 500	6415				6415N	90	174	2,5	5,74	
	100	10	0,6	10,35	10,1	6 000	4 600	7 000	61816		61816-2ZR		61816-2RSR	84	96	0,6	0,153	
	110	16	1	25,1	20,3	5 600	3 800	6 700	61916		61916-2ZR		61916-2RSR	85	105	1	0,4	
	125	14	0,6	32,9	31,6	5 000		6 000	16016					84	121	0,6	0,597	
	125	22	1,1	47,5	39,8	5 000	3 300	6 000	6016Z	6016-2ZR	6016RSR	6016-2RSR	6016N	85	118	1	0,86	
	140	26	2	72,2	53,1	4 700	3 200	5 000	6216Z	6216-2ZR	6216RSR	6216-2RSR	6216N	90	130	2	1,41	
85	170	39	2,1	123	85,8	4 000	2 700	4 700	6316Z	6316-2ZR	6316RSR	6316-2RSR	6316N	91	158	2	3,62	
	200	48	3	163	126	3 500		4 200	6416				6416N	95	184	2,5	6,27	
	110	13	1	14,6	15	5 300	3 400	6 300	61817		61817-2ZR		61817-2RSR	90	105	1	0,72	
	120	18	1,1	31,9	30	5 300	3 400	6 300	61917		61917-2ZR		61917-2RSR	91,5	113,5	1	0,27	
	130	14	0,6	34,1	32,9	4 700		5 600	16017					89	126	0,6	0,626	
	130	22	1,1	49,2	73	4 700	3 200	5 600	6017Z	6017-2ZR	6017RSR	6017-2RSR		90	123	1	0,98	
90	150	28	2	83	64,3	4 200	2 800	5 000	6217Z	6217-2ZR	6217RSR	6217-2RSR	6217N	95	140	2	1,79	
	180	41	3	133	96,2	3 800	2 500	4 500	6317Z	6317-2ZR	6317RSR	6317-2RSR	6317N	98	166	2,5	4,26	
	210	52	4	174	136	3 300		4 000	6417					105	190	3	7,88	
	115	13	1	15	15,6	5 300	3 400	6 300	61818		61818-2ZR		61818-2RSR	95	110	1	0,28	
	125	18	1,1	33,2	31,5	5 000	3 300	6 000	61918		61918-2ZR		61918-2RSR	96,5	118,5	1	0,59	
	140	16	1	41,5	39,1	4 500		5 300	16018					95	135	1	0,848	
95	140	24	1,5	58,4	49,2	4 500	3 000	5 300	6018Z	6018-2ZR	6018RSR	6018-2RSR		96	132	1,5	1,16	
	160	30	2	96,2	70,8	4 000	2 700	4 700	6218Z	6218-2ZR	6218RSR	6218-2RSR	6218N	100	150	2	2,16	
	190	43	3	144	108	3 500		4 200	6318				6318N	103	176	2,5	4,95	
	225	54	4	192	158	3 200		3 800	6418					110	205	3	11,4	
	120	13	1	19,3	17,6	5 000	3 200	6 000	61819		61819-2ZR		61819-2RSR	100	115	1	0,3	
	130	18	1,1	33,8	33,5	4 800	2 900	5 600	61919		61919-2ZR		61919-2RSR	101,5	123,5	1	0,61	
100	145	16	1	42,3	41,5	4 200		5 000	16019					100	140	1	0,89	
	145	24	1,5	60,7	54,1	4 200	2 800	5 000	6019Z	6019-2ZR	6019RSR	6019-2RSR		102	137	1,5	1,22	
	170	32	2,1	108	81	3 800		4 500	6219					107	158	2	2,6	
	200	45	3	142	113	3 300		4 000	6319					109	186	2,5	5,72	
	125	13	1	19,9	18,3	4 800	3 200	5 600	61820		61820-2ZR		61820-2RSR	105	120	1	0,31	
	140	20	1,1	42,3	41,5	4 500	3 100	5 300	61920		61920-2ZR		61920-2RSR	106,5	133,5	1	0,83	
105	150	16	1	34	32,5	4 200		5 000	16020					105	145	1	0,91	
	150	24	1,5	60	54,1	4 200	2 800	5 000	6020Z	6020-2ZR	6020RSR	6020-2RSR		106	142	1,5	1,27	
	180	34	2,1	123	92,6	3 500		4 200	6220					112	169	2	3,13	
	215	47	3	174	141	3 500		4 200	6320					113	201	2,5	7,07	
	250	58	4	195	222	2 400		3 200	6420								12,9	
	130	13	1	20,8	19,6	4 500	3 100	5 300	61821		61821-2ZR		61821-2RSR	110	125	1	0,32	
110	145	20	1,1	44,2	44	4 300	2 900	5 000	61921		61921-2ZR		61921-2RSR	111,5	155	1	1,2	
	160	18	1,5	40	38	4 000		4 800	16021					110	155	1	1,6	
	160	26	2	72,2	65,6	4 000	2 700	4 700	6021Z	6021-2ZR	6021RSR	6021-2RSR		113	151	2	1,59	
	190	36	2,1	133	104	3 300		4 000	6221					117	178	2	3,74	
	225	49	3	185	153	3 000		3 500	6321					119	211	2,5	8	
	140	16	1	21,6	23,6	4 300	2 900	5 000	61822		61822-2ZR		61822-2RSR	115	135	1	0,6	
115	150	20	1,1	43,6	45	4 000	2 800	4 800	61922		61922-2ZR		61922-2RSR	116,5	143,5	1	0,9	
	170	19	1	57,6	56,2	3 800		4 500	16022					115	165	1	1,46	
	170	28	2	82,5	72,2	3 800	2 500	4 500	6022Z	6022-2ZR	6022RSR	6022-2RSR		118	161	2	1,95	
	200	38	2,1	144	117	3 200		3 800	6222					122	188	2	4,37	
	240	50	3	204	178	2 800		3 300	6322					124	226	2,5	9,59	
	280	65	4	225	238	2 000		2 800	6422								18,34	

SINGLE ROW DEEP GROOVE BALL BEARINGS ZVL SLOVAKIA, a. s.

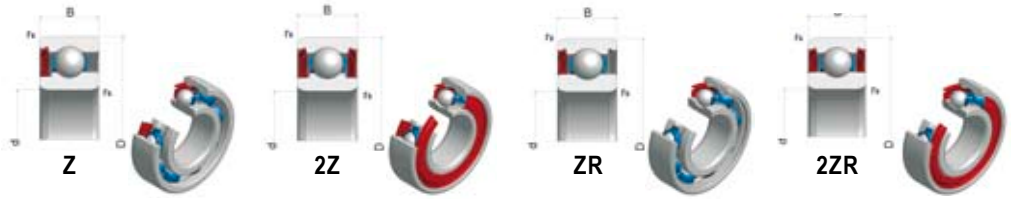

SINGLE ROW DEEP GROOVE BALL BEARINGS/SINGLE ROW DEEP GROOVE BALL BEARINGS WITH SHIELD AND SEAL/SINGLE ROW DEEP GROOVE BALL BEARINGS WITH SNAP RING GROOVE																			
DIMENSIONS mm				BASIC LOAD RATING kN		LIMITING SPEED FOR LUBRICATION WITH min ⁻¹				BEARING DESIGNATION					ABUTMENT AND FILLET DIMENSIONS			WEIGHT	
d	D	B	rs min	C	Co	Z, ZR	RS, SR	Standard	Z, ZR	2Z, 2ZR	RS, RSR	2RS, 2RSR	N	da max.	Da max.	ra max.			
120	150	16	1	22,4	25	3 800	2 800	4 500	61824					125	145	1	0,65		
	165	22	1,1	55,3	57	3 600	2 400	4 300	61924					126,5	158,5	1	1,2		
	180	19	1	61	63,1	3 300		4 000	60224					125	175	1	1,8		
	180	28	2	85	79,4	3 300	2 200	4 000	6024	6024ZR	6024-ZZR	6024RSR	6024-2RSR	128	171	2	2,1		
	215	40	2,1	144	117	3 000		3 500	6024					132	203	2	5,15		
	260	55	3	216	196	2 500		3 000	6324					134	246	2,5	12,2		
130	165	18	1,1	29	32,5	3 600		4 300	61826					136,5	158,5	1	0,93		
	180	24	1,5	51,1	51,1	3 400	2 200	4 000	61926					137	172	1	1,65		
	200	22	1,1	78	82,5	3 200		3 800	6026					138	172	1,5	2,69		
	200	33	2	106	100	3 200	2 100	3 800	6026	6026ZR	6026-ZZR	6026RSR	6026-2RSR	138	191	2	3,26		
130	230	40	3	153	133	2 800		3 300	6226					144	216	2,5	6,2		
	280	58	4	228	215	2 400		2 800	6326					146	263	3	15		
140	175	18	1,1	30,5	35,5	3 400	2 200	4 000	61828					146,5	168,5	1	0,99		
	190	24	1,5	66,3	72	3 200	2 100	3 800	61928					148	182	1,5			
	210	22	1,1	81	85,8	3 000		3 500	6028					146,5	203,5	1	2,86		
	210	33	2	110	108	3 000		3 500	6028					148	200	2	3,39		
	250	42	3	166	150	2 500		3 000	6228					154	236	2,5	7,56		
	300	62	4	251	246	2 200		2 700	6328					156	294	3	18,3		
150	190	20	1,1	37,5	43	3 000	2 000	3 600	61830					156,5	183,5	1	1,4		
	210	28	2	88,4	93	2 800	2 000	3 400	61930					159	201	1	3,04		
	225	24	1,1	92,6	98,1	2 700		3 200	6030					156,5	218,5	1	3,58		
	225	35	2,1	126	126	2 700		3 200	6030					159	213	2	4,16		
	270	45	3	190	181	2 200		2 700	6230					164	256	2,5	9,85		
	320	65	4	276	282	2 000		2 500	6330					166	304	3	21,8		
160	200	20	1,1	38	45,5	2 800	2 000	3 400	61832					166,5	193,5	1	1,45		
	220	28	2	92,3	98	2 600	1 900	3 200	61932					169	211	2	3,25		
	240	25	1,5	99,4	107	2 400		3 000	6032					168	232	1,5	3,6		
	240	38	2,1	143	144	2 500		3 000	6032					171	229	2	5,06		
	290	48	3	203	203	2 100		2 500	6232					173	277	2,5	15		
	215	22	1,1	47,5	56	2 600	1 900	3 200	61834					176,5	208,5	1	1,9		
170	230	28	2	93,6	106	2 400	1 800	3 000	61934					179	221	2	3,4		
	260	28	1,5	119	129	2 200		2 800	6034					178	252	1,5	5		
	260	42	2,1	168	171	2 200		2 700	6034					179	248	2	6,91		
	310	52	4	228	237	2 000		2 400	6234					181	249	2	16,5		
	360	72	4	335	378	1 500		1 900	6334					186	294	3	31,43		
	225	22	1,1	48	57	2 400	1 800	3 500	61836					186,5	218,5	1	2		
180	250	33	2	119	134	2 200	1 700	2 800	61936					189	241	2			
	280	31	2	138	146	2 000		2 600	6036					189	271	2	5,12		
	280	46	2,1	188	200	2 100		2 500	6036					191	269	2	8,88		
	320	52	4	242	261	1 900		2 200	6236					196	304	3	17,5		
	240	24	1,5	57	69,5	2 200	1 700	2 800	61838					198	232	1,5	2,6		
	260	33	2	117	134	2 200	1 700	2 800	61938					199	251	2	5,25		
190	290	31	2	150	166	2 000		2 600	6038					199	281	2	7,9		
	290	46	2,1	196	215	2 000		2 400	6038					201	279	2	9,31		
	340	55	4	271	299	1 800		2 100	6238					206	324	3	23,3		
	250	24	1,5	58,5	72	2 200	1 700	2 800	61840					208	242	1,5	2,7		
	280	38	2,1	148	166	2 000	1 600	2 600	61940					211	269	2	7,4		
	310	34	2,1	168	187	1 900		2 400	6040					209	301	2	10,1		
200	310	51	2,1	216	245	1 900		2 200	6040					211	299	2	11,9		
	360	58	4	282	332	1 700		2 000	6240					216	344	3	28		
	270	24	1,5	60	78	1 900	1 500	2 400	61844					228	262	1,5	3		
	300	38	2,1	161	180	1 900	1 500	2 400	61944					231	289	2	8		
	340	37	2,1	180	217	1 800		2 200	6044					231	329	2	13,5		
	340	56	3	247	291	1 800		2 200	6044M					233	327	2,5	19		
400	65	4	311	376	1 500		1 800	6244M					236	384	3	37			



SINGLE ROW DEEP GROOVE BALL BEARINGS ZVL SLOVAKIA, a. s.

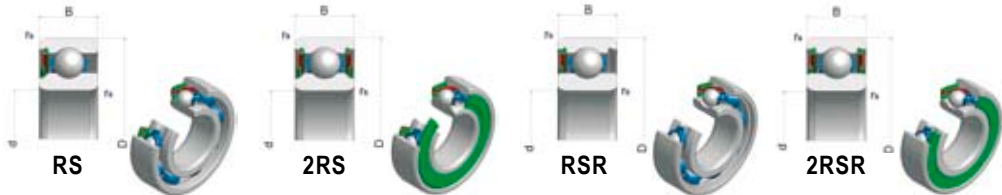

SINGLE ROW DEEP GROOVE BALL BEARINGS/SINGLE ROW DEEP GROOVE BALL BEARINGS WITH SHIELD AND SEAL/SINGLE ROW DEEP GROOVE BALL BEARINGS WITH SNAP RING GROOVE																		
DIMENSIONS mm				BASIC LOAD RATING kN		LIMITING SPEED FOR LUBRICATION WITH min ⁻¹				BEARING DESIGNATION					ABUTMENT AND FILLET DIMENSIONS			WEIGHT
d	D	B	rs min	C	Co	Z, ZR	RS, SR	Standard	Z, ZR	2Z, 2ZR	RS, RSR	2RS, 2RSR	N	da max.	Da max.	ra max.		
240	300	28	2	83	106	1 800	1 400	2 200	61848		61848-2ZR		61848-2RSR		249	291	2	4,5
	320	38	2,1	159	200	1 800	1 400	2 200	61948		61948-2ZR		61948-2RSR		251	309	2	8,6
	360	37	2,1	181	215	1 700		2 000	16048					251	349	2	14,1	
	360	56	3	247	295	1 700		2 000	6048M					253	347	2,5	19,5	
	440	72	4	360	470	1 300		1 600	6248M					256	424	3	51	
260	400	44	3	235	298	1 500		1 800	16052					273	387	2,5	21,6	
	400	65	4	294	373	1 500		1 800	6052M					276	384	4	28,5	
	480	80	5	335	594	1 100		1 400	6250M					280	460	4	65,5	
280	420	44	3	252	360	1 400		1 700	16056M					293	407	3	23	
	420	65	4	325	422	1 400		1 700	6056M					296	404	3	31	
	500	80	5	429	604	1 100		1 400	6256M					300	480	4	71	
300	460	50	4	285	403	1 200		1 500	16060M					316	444	3	32	
	460	74	4	357	492	1 200		1 500	6060M					316	444	3	43,5	
320	480	50	4	293	430	1 100		1 400	16064M					336	464	3	34	
	480	74	4	363	512	1 100		1 400	6064M					336	464	3	46,5	
340	520	27	4	345	515	1 000		1 300	16068M					356	504	3	45	
	520	82	5	437	663	1 000		1 300	6068M					360	500	4	61,5	
360	540	57	4	346	530	1 000		1 300	16072M					376	524	3	49	
	540	82	5	421	648	1 000		1 300	6072M					380	520	4	65	
380	560	57	4	375	620	1 000		1 300	16076M					396	544	3	50,6	
	560	82	5	438	700	950		1 200	6076M					400	540	4	67,5	
400	600	90	5	493	809	900		1 100	6080M					420	580	4	91	



SINGLE ROW ANGULAR CONTACT BALL BEARINGS



SINGLE ROW ANGULAR CONTACT BALL BEARINGS

MAIN DIMENSIONS

The main and connection dimensions of the bearings specified in the dimension tables are in accordance with the international standards ISO 15 (STN 02 4629).

SINGLE ROW ANGULAR CONTACT BALL BEARINGS $\alpha = 26^\circ$, $\alpha = 40^\circ$

The group of single row angular contact ball bearings comprises of bearings with contact angle $\alpha = 26^\circ$ and $\alpha = 40^\circ$ designed for standard seating and the high-precise single row ball bearings designed for high rotation speed.

These products have deep raceway that enables the absorption of radial load at relative heavy axial load in single direction. The bearings are mounted in pairs – face to face or back to back - in order to absorb the axial load in both directions.

SINGLE ROW ANGULAR CONTACT BALL BEARINGS DESIGNATED FOR HIGH ROTATION SPEED

Single row angular contact ball bearings designated for high rotation speed and high precision of seating differ from standard angular contact ball bearings by inner design of bearing rings, contact angle dimension of the ball with the raceways of the rings, construction of cage, high precision degree of operation. The bearings are non-separable and their correct arrangement assures required firmness and precision of seating. The bearings have textite cage guided on the inner ring (TB) or on the outer ring (TA).

TOLERANCE

Single row angular contact ball bearings are commonly produced in tolerance classes P0 and P6 according to the standard ISO 495. Production of bearings with higher tolerance class (P5 or P4) should be discussed in advance.

RADIAL EQUIVALENT DYNAMIC LOAD

Angular Contact Ball Bearings $\alpha = 40^\circ$, type B:

$$P_r = F_r \quad \text{for } F_a/F_r \leq 1,14$$

$$P_r = 0,35F_r + 0,57F_a \quad \text{for } F_a/F_r > 1,14$$

Angular Contact Ball Bearings $\alpha = 26^\circ$, type AA:

$$P_r = F_r \quad \text{for } F_a/F_r \leq 0,68$$

$$P_r = 0,41F_r + 0,87F_a \quad \text{for } F_a/F_r > 0,68$$

RADIAL EQUIVALENT STATIC LOAD

Angular Contact Ball Bearings $\alpha = 40^\circ$, type B:

$$P_{or} = 0,5F_r + 0,26F_a \quad (P_{or} \geq F_r)$$

Angular Contact Ball Bearings $\alpha = 26^\circ$, type AA:

$$P_{or} = 0,5F_r + 0,37F_a \quad (P_{or} \geq F_r)$$

DESIGNATION

Designation of standard single row angular contact ball bearings is specified in the dimension tables. Modification of the basic design is designated with additional symbols according to STN 02 4608.

The meaning of the most used symbols for single row angular contact ball bearings

SYMBOL	EXAMPLE	MEANING
AA	7203AA	Contact angle $\alpha = 26^\circ$, pressed steel cage
B	7304B	Contact angle $\alpha = 40^\circ$, pressed steel cage
BETNG	7206BETNG	Contact angle $\alpha = 40^\circ$, higher load rating, machined cage made of polyamide, rolling elements centered
TB	B7204AATB	Cage made of textite guided on the inner ring for high rotation speed
P6	7206B P6	Higher tolerance class than standard

SINGLE ROW ANGULAR CONTACT BALL BEARINGS ZVL SLOVAKIA, a. s.

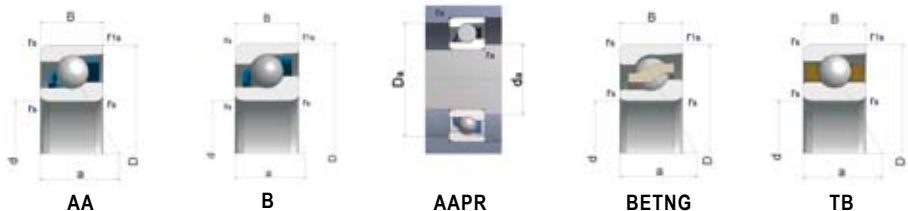

DIMENSIONS mm				BASIC LOAD RATING kN		LIMITING SPEED FOR LUBRICATION min ⁻¹		BEARING DESIGNATION	WEIGHT	ABUTMENT AND FILLET DIMENSIONS			
d	D	B	rs min	C	Co					kg	da max.	Da max.	ra max.
10	30	9	0,6	7,3	2,9	19 000	26 000	7200BETNG	0,031		15	26	0,6
	32	10	0,6	7,5	3,8	19 000	26 000	7201BETNG	0,036		17	27	0,6
12	32	10	0,6	6,9	3,2	19 000	26 000	7201B	0,037		17	27	0,6
	35	11	0,6	9,2	4,9	17 000	20 000	7202B	0,05		19	31	0,6
15	35	11	0,6	7,36	4,38	17 000	20 000	7202BETNG	0,05		19	31	0,6
	35	11	0,6	8,1	4,82	17 000	20 000	B7202AATB	0,052		19	31	0,6
17	40	12	0,6	9,9	5,5	14 000	19 000	7203BETNG	0,065		21	36	0,6
	40	12	0,6	9,9	5,5	14 000	19 000	7203B	0,65		21	36	0,6
	47	14	1	14,1	7,94	12 600	15 000	B7303AATB	0,125		23	41	1
	47	14	1	13,3	7,94	12 600	15 000	7303BETNG	0,125		23	42	1
	47	14	1	13,3	7,22	12 600	15 000	7303B	0,12		23	41	1
	47	14	1	13,3	7,64	12 000	16 000	7204B	0,11		25	42	1
20	47	14	1	13,3	7,64	12 000	16 000	B7204BETNG	0,111		25	45	1
	47	14	1	14,4	8,58	12 000	16 000	B7204AATB	0,111		25	42	1
	52	15	1,1	17,3	9,6	11 000	15 000	7304B	0,14		25	42	1
	52	15	1	14,8	9,3	10 000	14 000	7205B	0,12		30	47	1
25	52	15	1	13,6	8,1	10 000	14 000	B7205AATB	0,124		30	47	1
	52	15	1	15,8	9,81	10 000	14 000	7205BETNG	0,135		30	47	1
	62	17	1,1	24,2	14,7	9 400	11 000	7305BETNG	0,242		36	65	1
	62	17	1,1	24,2	14,7	9 400	11 000	7305B	0,24		36	65	1
30	62	16	1	23	14,7	9 000	13 000	7206BETNG	0,19		35	57	1
	62	16	1	23	14,7	9 000	13 000	7206B	0,19		35	57	1
	62	16	1	18,8	11,7	9 000	13 000	B7206AATB	0,189		35	57	1
	72	19	1,1	32,5	19,6	7 900	9 400	7306B	0,36		36	65	1
35	72	17	1,1	27,1	18,5	8 000	11 000	7207B	0,28		42	65	1
	80	21	1,5	38,3	24,2	7 000	9 500	7307B	0,45		42	71	1,5
40	80	18	1,1	34,5	23,8	6 700	9 000	7208B	0,42		47	73	1
	80	18	1,1	36,9	24,6	6 700	9 000	7208BETNG	0,42		47	73	1
	80	18	1,1	37,6	26,6	6 700	9 000	B7208AATB	0,42		47	73	1
	90	23	1,5	48,2	33,5	6 300	7 500	B7308AATB	0,662		47	81	1,5
	90	23	1,5	46,5	29,5	6 300	8 500	7308BETNG	0,63		47	81	1,5
45	90	23	1,5	46,5	29,5	6 300	8 500	7308B	0,63		47	81	1,5
	85	19	1,1	39,8	29,3	6 700	8 500	7209B	0,42		52	78	1
	85	19	1,1	39,8	29,3	6 700	8 500	7209BETNG	0,42		52	78	1
	85	19	1,1	39,8	29,3	6 700	8 500	B7209AATB	0,42		52	78	1
	100	25	1,5	59,6	39,6	5 600	7 500	7309B	0,85		52	81	1,5
50	90	20	1,1	40,4	25,6	5 600	8 000	7210B	0,47		57	83	1
	90	20	1,1	40,4	25,6	5 600	8 000	7210BETNG	0,47		57	83	1
	90	20	1,1	40,4	25,6	5 600	8 000	B7210AATB	0,47		57	83	1
	110	27	2	68,1	48,2	5 000	6 000	7310B	1,14		60	100	2
55	100	21	1,5	51,1	40,6	5 300	7 000	7211B	0,62		62	91	1,5
	100	21	1,5	51,1	39,8	5 300	7 000	7211BETNG	0,62		62	91	1,5
	100	21	1,5	51,1	40,6	5 300	6 300	B7211AATB	0,62		62	91	1,5
	120	29	2	82,2	56,2	4 500	5 600	7311B	1,4		65	110	2

SINGLE ROW ANGULAR CONTACT BALL BEARINGS ZVL SLOVAKIA, a. s.

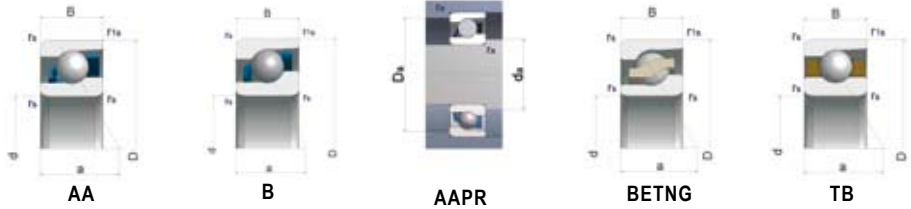

DIMENSIONS mm				BASIC LOAD RATING kN		LIMITING SPEED FOR LUBRICATION min ⁻¹		BEARING DESIGNATION	WEIGHT	ABUTMENT AND FILLET DIMENSIONS		
d	D	B	rs min	C	Co				kg	da max.	Da max.	ra max.
60	110	22	1,5	61,9	50,1	5 300	7 000	7212B	0,8	67	101	1,5
	110	22	1,5	61,9	50,1	5 300	7 000	7212BETNG	0,8	67	101	1,5
	110	22	1,5	61,9	50,1	5 300	7 000	B7212AATB	0,8	67	101	1,5
	130	31	2,1	90	65,6	4 200	5 000	7312B	1,81	72	118	2
65	120	23	1,5	65,7	50,2	4 300	6 000	7213B	1	72	111	1,5
	120	23	1,5	65,7	50,2	4 300	6 000	B7213AATB	1	72	111	1,5
	140	33	2,1	102,3	75,3	3 800	5 300	7313B	2,15	76	128	2
70	125	24	1,5	70,4	56,3	4 000	5 600	7214B	1,1	77	116	1,5
	125	24	1,5	70,4	56,3	4 000	5 600	7214BETNG	1,1	77	116	1,5
	150	35	2,1	114,6	85,9	3 600	5 000	B7314AATB	2,65	81	138	2
	150	35	2,1	114,6	85,9	3 600	5 000	7314B	2,65	81	138	2
75	130	25	1,5	68,6	58,2	3 800	5 300	7215B	1,2	82	121	1,5
	130	25	1,5	68,6	58,2	3 800	5 300	7215BETNG	1,2	82	121	1,5
	160	37	2,1	127,7	95,4	3 400	4 800	7315BETNG	3,2	86	148	2
80	160	37	2,1	127,7	95,4	3 400	4 800	7315B	3,2	86	148	2
	140	26	2,1	78,7	65,7	4 000	5 300	7216B	1,45	90	130	2
85	170	39	2,1	135	110	3 200	4 400	7316BM	3,64	92	158	2
	150	28	2,1	83,2	74,1	3 600	5 000	7217B	1,85	95	14	2
90	160	30	2	107	95	3 200	4 400	7218B	2,34	101	149	2
	190	43	3	156	134	2 800	4 000	7318AA	4,98	104	176	2,5
95	200	45	3	168	150	2 700	3 800	7319AA	5,77	109	186	2,5
	180	34	2,1	131	116	2 800	4 000	7220B	3,29	112	168	2
100	215	47	3	197	184	2 500	3 500	7320AA	7,17	114	201	2,5
	200	38	2,1	159	148	2 500	3 600	7222BM	4,75	122	188	2
	240	50	3	225	224	2 200	3 200	7322AA	9,7	124	226	2,5
110	215	40	2,1	162	163	2 400	3 300	7224AA	5,89	132	203	2
	260	55	3	238	250	2 100	2 900	7324AA	13,8	134	246	2,5
	230	40	3	181	186	2 200	3 100	7226AA	6,75	144	216	2,5
120	280	58	4	275	303	1 900	2 700	7326BM	17,1	147	263	3
	250	42	3	197	210	2 100	2 900	7228AA	8,65	154	236	2,5
	300	62	4	301	342	1 800	2 500	7328BM	21,3	157	283	3
130	270	45	3	218	241	1 900	2 600	7230AAM	10,7	164	256	2,5
	320	65	4	329	384	1 700	2 400	7330B	24,8	167	302	3





SINGLE ROW FOUR-POINT ANGULAR CONTACT BALL BEARINGS

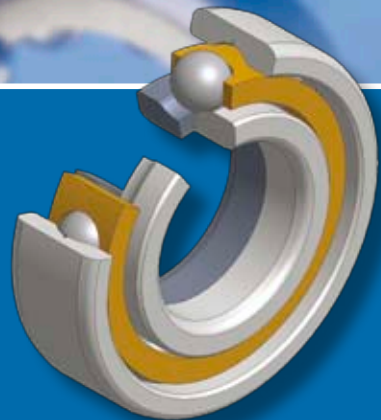
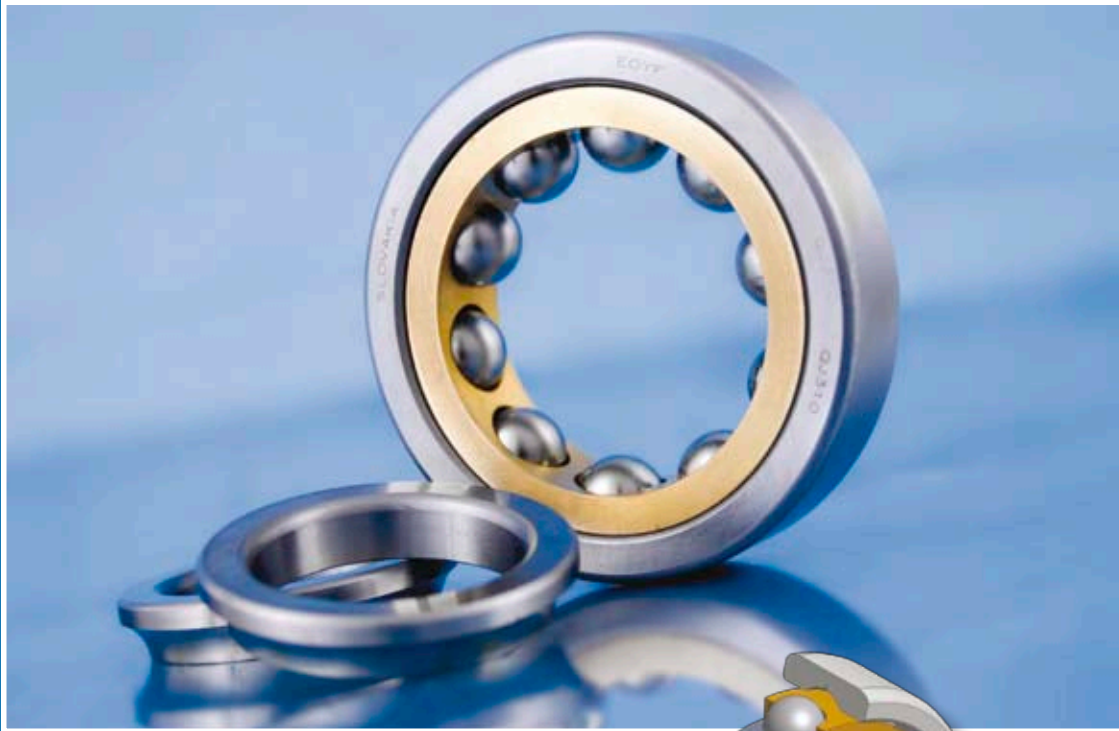

SINGLE ROW FOUR-POINT ANGULAR CONTACT BALL BEARINGS

Single row four-point angular contact ball bearings are single row angular contact bearings. The raceways of these bearings are designed to accept axial load in both directions.

In the axial direction arrangement, single row four-point angular contact ball bearings require less space than double row angular contact ball bearings. The contact angle is 35°. The two-part inner ring allows the bearing to be filled with more balls, which creates a design with higher load rating. Whereas these bearings are separable, the outer ring with a filled cage can be mounted in the arrangement separately.



DESIGN SPECIFICATION

SNAP RING GROOVES

Single row four-point angular contact ball bearings are designed to carry mainly axial loads and their clearance in the housing is similar to the clearance of axial bearings. Bearings with outer diameter higher than 160 mm are made with two snap ring grooves in the outer ring (type N2) to enable simple fixing, which stops the outer ring from twisting. For the groove dimensions see the following table.

OUTER DIAMETER D (mm)		DIMENSIONS mm					
over	incl.	RAD QJ 2			RAD QJ 3		
		b	h	r _o	b	h	r _o
—	170	6,5	8,1	1	8,5	10,1	2
170	210	8,5	10,1	2	10,5	11,7	2
210	270	10,5	11,7	2	10,5	11,7	2

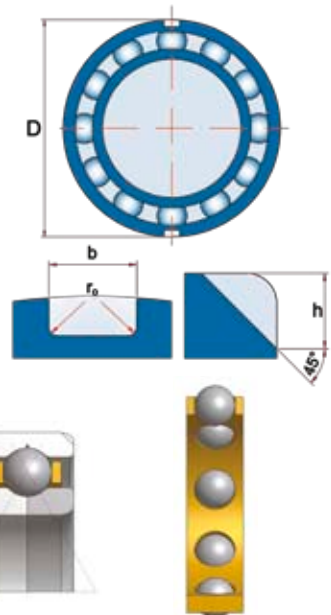

CAGE

Single row four-point angular contact ball bearings are mainly equipped with a massive brass cage. They can also be equipped with a glass fiber reinforced polyamide cage.



DIMENSIONS

The dimensions of single row four-point angular contact ball bearings are in the table part and they are in accordance with the international standards ISO 15.

MISALIGNMENT

Single row four-point angular contact ball bearings can accommodate the misalignment of the rings by aligning the outer ring towards the inner ring at a limited degree. Factors influencing the alignment of these bearings are the same as in the case of single row deep groove ball bearings. Any misalignment produces increased vibration level whilst the bearing is in operation. If the single row four-point angular contact ball bearings are combined in the arrangement with other radial bearings so they shall operate as axial bearings, there must be a radial clearance in the housing and aligning of the outer ring will not be possible.

EQUIVALENT DYNAMIC LOAD

$$P = Fr + 0,66 \cdot Fa \quad (\text{kN}) \text{ for } Fa/Fr \leq 0,95$$

$$P = 0,6 \cdot Fr + 1,07 \cdot Fa \quad (\text{kN}) \text{ for } Fa/Fr > 0,95$$

To prevent unacceptable friction, the axial load applied on the single row four-point angular contact ball bearing should ensure a contact of every ball with the raceways in two points only.

EQUIVALENT STATIC LOAD

$$Po = Fr + 0,58 \cdot Fa$$

SINGLE ROW FOUR-POINT ANGULAR CONTACT BALL BEARINGS ZVL SLOVAKIA, a. s.

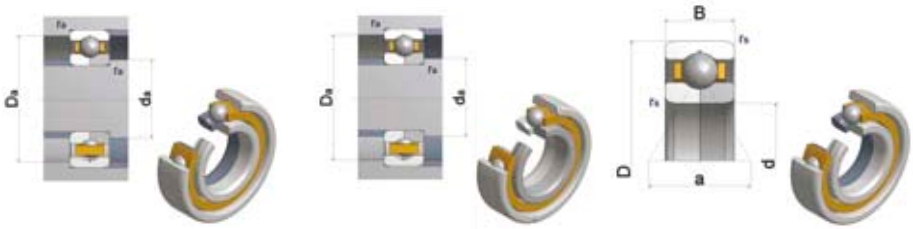

DIMENSIONS mm					LIMITING SPEED FOR LUBRICATION min ⁻¹		BASIC LOAD RATING kN		BEARING DESIGNATION	ABUTMENT AND FILLET DIMENSIONS			WEIGHT kg
d	D	B	rs min.	-a	C	Co				da max.	Da max.	ra max.	
17	40	12	0,6	20	15,9	10,6	14 000	19 000	QJ203	22	35	0,6	0,082
	47	14	1	22	23,4	15	12 000	17 000	QJ303	23	41	1	0,14
20	52	15	1,1	25	29,6	20	10 000	15 000	QJ304	27	45	1	0,18
25	52	15	1	27	25,1	20	9 500	14 000	QJ205	31	46	1	0,16
	62	16	1	32	35,1	28,5	8 500	12 000	QJ206	36	56	1	0,24
30	72	19	1,1	36	49,4	39	7 500	10 000	QJ306	37	65	1	0,42
	72	17	1,1	37	31,3	27	6 500	7 200	QJ207	42	65	1	0,35
35	80	21	1,5	40	48,5	41,6	6 000	6 600	QJ307	44	71	1,5	0,57
	80	18	1,1	42	36,3	32	6 100	6 700	QJ208	47	73	1	0,45
40	90	23	1,5	46	61,3	56,5	5 900	6 400	QJ308	49	81	1,5	0,78
	85	19	1,1	46	39,2	35,2	6 800	6 600	QJ209	52	78	1	0,52
45	100	25	1,5	51	73,1	68,2	5 700	6 300	QJ309	54	91	1,5	1,05
	90	20	1,1	49	49	45	4 800	5 500	QJ210	57	83	1	0,59
50	110	27	2	56	76,5	72,2	4 600	6 200	QJ310	60	100	2	1,35
	100	21	1,5	54	55,3	53,5	4 500	6 000	QJ211	64	91	1,5	0,77
55	120	29	2	61	88,9	75,6	3 800	5 100	QJ311	65	110	2	1,75
	110	22	1,5	60	64,6	60,5	4 100	5 300	QJ212	69	101	1,5	0,99
60	130	31	2,1	67	102,2	87,5	3 600	4 700	QJ312	72	118	2	2,15
	120	23	1,5	65	72,8	68,8	3 600	4 700	QJ213	74	111	1,5	1,2
65	140	33	2,1	72	115,5	102,2	3 400	4 500	QJ313	77	128	2	2,7
	125	24	1,5	38	79,8	75,8	3 600	4 700	QJ214	79	116	1,5	1,3
70	150	35	2,1	77	130,2	116,2	3 100	4 100	QJ314	82	138	2	3,15
	130	25	1,5	72	117	122	4 000	5 300	QJ215	84	121	1,5	1,45
75	160	37	2,1	82	199	186	3 400	4 500	QJ315N2	87	148	2	3,9
	140	26	2	77	138	146	3 600	4 800	QJ216	90	130	2	1,85
80	170	39	2,1	82	216	208	3 200	4 300	QJ316N2	92	158	2	4,6
	150	28	2	83	148	160	3 400	4 500	QJ217	95	140	2	2,25
85	180	41	3	93	234	236	3 000	4 000	QJ317N2	99	166	2,5	5,45
	160	30	2	88	174	186	3 200	4 300	QJ218N2	100	150	2	2,75
90	190	43	3	98	265	285	2 800	3 800	QJ318N2	104	176	2,5	6,45
	170	32	2,1	93	199	212	3 000	4 000	QJ219N2	107	158	2	3,35
95	200	45	3	103	286	315	2 600	3 600	QJ319N2	109	186	2,5	7,45
	180	34	2,1	98	225	240	2 800	3 800	QJ220N2	112	168	2	4,05
100	215	47	3	110	307	340	2 400	3 400	QJ320N2	114	201	2,5	9,3
	200	38	2,1	109	265	305	2 400	3 400	QJ222N2	122	188	2	5,6
110	240	50	3	123	364	430	2 000	3 000	QJ322N2	124	226	2,5	12,5
	215	40	2,1	117	286	340	2 200	3 200	QJ224N2	132	203	2	6,95
120	260	55	3	133	390	490	1 900	2 800	QJ324N2	134	246	2,5	16
	230	40	3	126	296	365	1 900	2 800	QJ226N2	144	216	2,5	7,75
130	280	58	4	144	423	560	1 800	2 600	QJ326N2	148	262	3	19,5
	250	42	3	137	325	440	1 800	2 600	QJ228N2	154	236	2,5	9,85
140	300	62	4	154	468	640	1 700	2 400	QJ328N2	158	282	3	24
	270	45	3	147	338	465	1 700	2 400	QJ230N2	164	256	2,5	12,5
150	320	65	4	165	494	710	1 600	2 200	QJ330N2	168	302	3	29
	290	48	3	158	390	570	1 600	2 200	QJ232N2	174	276	3	15,5
160	310	52	4	168	397	600	1 600	2 200	QJ234N2	188	292	3	19,5
	360	72	4	186	618	965	1 400	1 900	QJ334N2	188	342	3	41,5
170	320	52	4	175	436	680	1 500	2 000	QJ236N2	198	302	3	20,5
	380	75	4	196	637	1020	1 300	1 800	QJ336N2	198	362	3	47,5
200	360	58	4	196	507	850	1 300	1 800	QJ240N2	218	342	3	28,5
	400	65	4	217	553	980	1 100	1 500	QJ244N2	238	382	3	39,5



DOUBLE ROW ANGULAR CONTACT BALL BEARINGS



DOUBLE ROW ANGULAR CONTACT BALL BEARINGS

Double row angular contact ball bearings correspond with their construction and function to a pair of single row angular contact ball bearings in an "O" arrangement. They have relatively deep raceways on both rings, filling slot on one side and they are non-separable.

By optimal size of the balls and their conformity to the raceways relatively high load ratings are achieved. They can carry axial and radial loads in both directions and are suitable even for high rotation speeds. The bearings should be mounted so that the forces should not act against the filling slot. These bearings are manufactured in a broad selection of types and are the most common rolling bearing type.



DESIGN SPECIFICATION

MAIN DIMENSIONS

Main dimensions of double row angular contact ball bearings specified in the dimension tables are in accordance with the international standards ISO 15. The bearings are commonly produced in the basic P0 tolerance class. Double row angular contact ball bearings are very sensitive to the misalignment of the rings.

BEARINGS WITH SHIELDS OR SEALS

Double row angular contact ball bearings with sealing on one or on both sides are manufactured with metal shields (ZR, -2ZR) or with seals (RSR, -2RSR). The sealing rings made of rubber, vulcanized on metal reinforcing ring, provide an effective friction type sealing. The bearings are manufactured in the design with a seal and a flat collar of the inner ring (RSR, -2RSR).

Bearings with seals are suitable for operation within the temperature range from -30 °C to 110 °C. Delivery of bearings with seals within the operating temperature range from -40 °C to 250 °C (RSR2, -2RSR2) should be discussed in advance.

Bearings sealed on both sides -2ZR, -2RSR) are filled with a quality lubricant the properties of which usually ensure the lubrication during the whole bearing life under normal operating conditions. The bearings of this design cannot be relubricated. They can be used within the operating temperature range from -30 °C to 110 °C. The delivery of bearings with different lubricant should be discussed with the supplier in advance.

LUBRICATION

For bearings sealed on both sides, the designation of the lubricant filling different from standard lubricant is indicated by a symbol combination. The first two letters indicate the operating temperature range (a symbol in accordance with STN 02 4608) and the third identifies the lubricant name.

- TL** - Lubricant for low operating temperatures (from -60 °C to 100 °C)
- TM** - Lubricant for medium operating temperatures (from -30 °C to 110 °C)
- TH** - Lubricant for high operating temperatures (from -40 °C to 250 °C)
- TW** - Lubricant for low and high operating temperatures (from -40 °C to 150 °C)

Note: The symbols of lubricants for medium operating temperatures need not to be marked on the bearings.

CAGE

The single row deep groove ball bearings of the basic design are equipped with a pressed cage made of steel sheet, guided on balls, which is not designated. The cages for double row angular contact ball bearings are manufactured in two version in dependence on the inner construction of the bearing. (see picture).

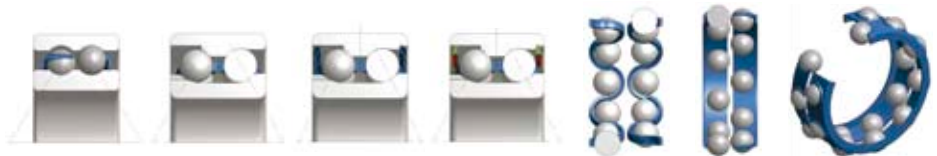

In special cases the bearings are produced with different types of cages: bearings with a solid polyamide cage (TNH, TNH), with a solid cage of textite (TB). The supply of these bearings should be discussed in advance.

DOUBLE ROW ANGULAR CONTACT BALL BEARINGS

TOLERANCES

Single row deep groove ball bearings are produced in tolerance classes P0 and P6. For special arrangements requiring high precision or for arrangements with a high rotation speed, the bearings with higher tolerance classes P6, P5 and P4 are used. The bearings with higher tolerance class P6E are used for rotating electric machines. The limit values of deviations in tolerances and the operation are specified in ISO 492.

BEARING CLEARANCE

Commonly manufactured double row angular contact ball bearings have a normal vibration level checked by the manufacturer. For special arrangements bearings with reduced vibration level (C6) are produced.

VIBRATION LEVEL

Commonly produced double row angular contact bearings have standard vibration level specified by the manufacturer. For special arrangements with silent running bearings with reduced vibration level (C6) are produced.

COMBINATION OF SYMBOLS

The symbols for the tolerance classes, internal bearing clearances and vibration levels are combined with the simultaneous omission of the symbol C in the second and the following bearing special characteristics e. g.:

P6 + C3 = P63	3205 P63
C3 + P6 = C36	3205-2RSR C36
P6 + C3 + C6 = P636	3205-2ZR P636

MISALIGNMENT

The misalignment of the rings is not admissible for double row angular contact ball bearings. The misalignment causes additional load of the bearing and the durability is lowered.

RADIAL EQUIVALENT DYNAMIC LOAD

Double row angular contact ball bearings:

P = Fr + 0,73.Fa	pre Fa/Fr ≤ 0,68
P = 0,67. Fr + 1,41.Fa	pre Fa/Fr > 0,68

DESIGNATION

The designation of basic designs and common modifications of the bearings are specified in the dimension tables. Modification of the basic design is designated with additional symbols according to STN 02 4608. The meaning of the most used symbols for single row deep groove ball bearings is in the table.

SYMBOL	EXAMPLE OF DESIGNATION	MEANING
-RSR	3205RSR	Seal on one side adhering to a flat surface of the inner ring
-2RSR	3307-2RSR	Seal on both sides adhering to a flat surface of the inner ring
-ZR	3206-ZR	Metal shield on one side
-2ZR	3208-2ZR	Metal shields on both sides adhering to a flat surface of the inner ring
TNH	3309TNH	Plastic cage guided on balls
P6	3205 P6	Higher tolerance class than standard
P5	3307E P5	Higher tolerance class than P6
C2	3304 C2	Radial clearance less than normal
C3	3305-2ZR C3	Radial clearance greater than normal
C4	3307-2RS C4	Radial clearance greater than C3
C5	3206-2ZR C5	Radial clearance greater than C4
C6	3305 C6	Reduced vibration level

DOUBLE ROW ANGULAR CONTACT BALL BEARINGS ZVL SLOVAKIA, a. s.

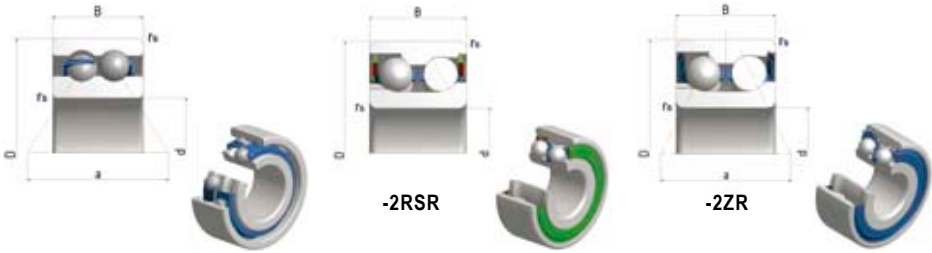

DIMENSIONS mm					LIMITING SPEED FOR LUBRICATION min ⁻¹		BASIC LOAD RATING kN		BEARING DESIGNATION	ABUTMENT AND FILLET DIMENSIONS			WEIGHT kg
d	D	B	rs min	a						da max.	Da max.	ra max.	
10	30	14,3	0,6	17,4	16000	19000	5,8	3,56	3200	14	25	0,5	0,05
12	32	15,9	0,6	19,4	14000	17000	7,48	4,43	3201	18,5	26	0,5	0,06
15	35	15,9	0,6	21,4	13000	16000	8,05	5,26	3202	21,5	29,5	0,5	0,07
	42	19	1	27	10600	12600	15,8	11,9	3302	21,5	38	0,6	0,13
17	40	17,5	0,6	24,4	11000	13000	10,64	7,02	3203	24,5	33,5	0,6	0,1
	47	22,2	1	27,5	9400	11000	20,5	12,5	3303	24,5	41,5	0,6	0,19
20	47	20,6	1	29,3	9400	11000	13,82	11,52	3204	29,5	40,5	1	0,17
	52	22,2	1,1	30,9	8400	10000	12,22	18,77	3304	29,5	45,5	1	0,23
25	52	20,6	1	32,1	8400	10000	15,64	12,7	3205	33,5	45,5	1	0,188
	52	20,6	1	35	8400	10000	18,94	18,088	3205E	31	42	1	0,186
25	62	25,4	1,1	37,2	7100	8400	17,36	20,08	3305	36,5	50,5	1	0,367
	62	25,4	1,1	40	7100	8400	34,67	26,91	3305E	34	47	1	0,367
30	62	23,8	1	38,5	7100	8400	27,39	20,36	3206	39,5	53,5	1	0,31
	62	23,8	1	39,1	7100	8400	28,76	27,95	3206E	37	51	1	0,31
30	72	30,2	1,1	44,8	6000	7100	39,13	27,13	3306	43	61,5	1	0,58
	72	30,2	1,1	45,2	6000	7100	38,94	36,73	3306E	41	57	1	0,575
35	72	27	1,1	44,7	6000	7100	37,14	27,16	3207	45,5	61,5	1	0,48
	72	27	1,1	44,7	6000	7100	38,31	38,44	3207E	41	57	1	0,48
35	80	34,9	1,5	50,9	5300	6300	48,88	34,88	3307	49	68	1,5	0,78
	80	34,9	1,5	52,2	5300	6300	49,92	47,79	3307E	45	64	1,5	0,78
40	80	30,2	1,1	49	5300	6300	39,57	31,24	3208	53	69	1	0,65
	80	30,2	1,1	49,8	5300	6300	42,72	44,68	3208E	51	66	1	0,635
40	90	36,5	1,5	55,7	4700	5600	40,16	54,98	3308	56	73	1,5	1,05
	90	36,5	1,5	56,5	4700	5600	67,16	66,39	3308E	53	70	1,5	1,02
45	85	30,2	1,1	52,1	5000	6000	39,37	32,02	3209	57	73	1	0,7
	85	30,2	1,1	52,7	5000	6000	47,35	46,32	3209E	55	71	1	0,7
45	100	39,7	1,5	62,2	4200	5000	72,54	54,9	3309	57	88	1,5	1,375
	100	39,7	1,5	62,2	4200	5000	87,17	74,43	3309E	55	85	1,5	1,375

DOUBLE ROW ANGULAR CONTACT BALL BEARINGS ZVL SLOVAKIA, a. s.



DIMENSIONS mm					LIMITING SPEED FOR LUBRICATION min ⁻¹		BASIC LOAD RATING kN		BEARING DESIGNATION	ABUTMENT AND FILLET DIMENSIONS			WEIGHT kg
d	D	B	r _{smin}	a						da max.	Da max.	ra max.	
50	90	30,2	1,1	55,2	4500	5300	41,53	35,73	3210	62	78	1	0,74
	110	44,4	2,1	73	3800	4500	85,44	65,11	3310	62	100	2	1,9
55	100	33,3	1,5	61,8	4200	5000	53,27	46,35	3211	62	91	1,5	1,05
	120	49,2	2,1	80	3300	4000	82,63	106,37	3311	65	110	2	2,48
60	110	36,5	1,5	67,4	3800	4500	59,99	54,43	3212	67	101	1,5	1,36
	130	54	2,1	86	3200	3800	95,82	121,62	3312	72	118	2	3,17
65	120	38,1	1,5	76	3500	4200	66,37	73,4	3213	72	111	1,5	1,76
	140	58,7	2,1	94	3000	3500	110	137,62	3313	77	128	2	4,01
70	125	39,7	1,5	81	3200	3800	73,49	80,51	3214	77	116	1,5	1,93
	150	63,5	3	101	2800	3800	134	127	3314	82	138	2	5,05
75	130	41,3	1,5	84	3200	3800	81,52	87,9	3215	82	121	1,5	2,08
	160	68,3	3	107	2600	3600	140	137	3315	87	148	2	6,15
80	140	44,4	3	91	2800	3600	91,5	95	3216	90	130	2	2,65
	170	68,3	3	111	2400	3400	160	156	3316	92	158	2	6,95
85	150	49,53	3	97	2600	3600	98	104	3217	95	140	2	3,4
	180	73	4	119	2200	3200	176	176	3317	99	166	2,5	8,3
90	160	52,4	3	104	2400	3400	116	125	3218	100	150	2	4,15
	190	73	4	125	2000	3000	200	208	3318	104	176	2,5	9,25
95	170	55,6	3	112	2200	3200	134	146	3219	107	158	2	5
	200	77,8	4	133	1900	2800	216	236	3319	109	186	2,5	11
100	180	60,3	3	118	2000	3000	143	156	3220	112	168	2	6,1
	215	82,6	4	139	1800	2600	232	260	3320	114	201	2,5	13,5
110	200	69,8	3	132	1900	2800	173	193	3222	122	188	2	8,8
	240	92,1	4	154	1700	2400	265	315	3322	124	226	2,5	19

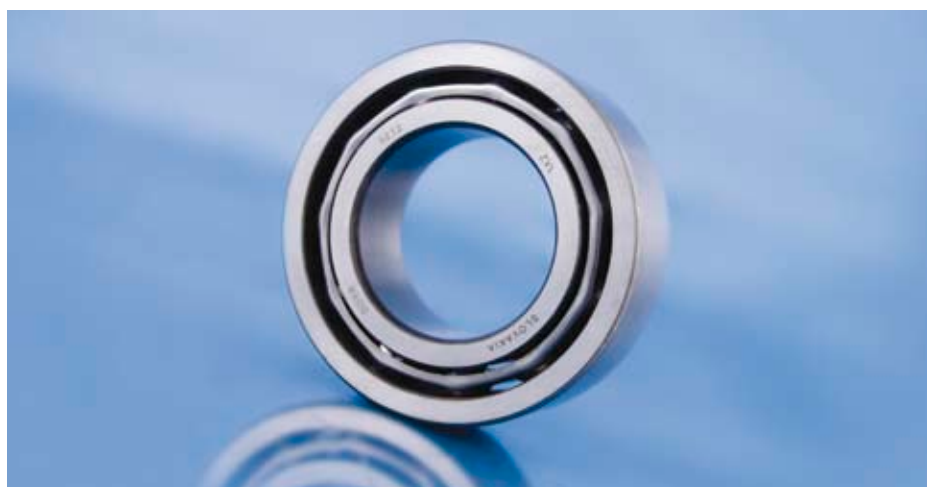



DOUBLE ROW SELF-ALIGNING BALL BEARINGS



DOUBLE ROW SELF-ALIGNING BALL BEARINGS

Double row self-aligning ball bearings have spherical raceway on the outer ring. They can misalign and also the misalignment of seating is acceptable for them. Double row self-aligning ball bearings are produced with cylindrical or tapered bore and they are non-separable.

Misaligning ability without impairing the bearing's proper functions allows the application of the bearings where a higher bore misalignment in bearing housings or deflection and oscillation of shaft can be expected. Because of the small contact angle and imperfect adhesion of the balls to the raceways they are not suitable for higher axial loads.



DESIGN SPECIFICATIONS

MAIN DIMENSIONS

Main dimensions of double row self-aligning ball bearings specified in the dimension tables are in accordance with the international standards ISO 15. The adapter sleeve dimensions also comply with international standards ISO 113.

TAPERED BORE

Bearings with tapered bore have taper 1:12. Adapter sleeves are used to mount bearings with tapered bore on cylindrical shafts. Sleeve designation of the individual bearings are stated in the table section.

CAGE

Double row self-aligning ball bearings have in the basic application pressed steel cage that is not indicated. There can be one-piece cages /line 12..., 13.../ and two-part cages /line 22..., 23.../

TOLERANCE

The double row self-aligning ball bearings are commonly manufactured within the normal tolerance class P0. For special applications requiring high accuracy or with high rotation speed bearings with higher tolerance classes P6, P5, P4 are used. Limiting values of dimension deviations and operation are stated in the norm ISO 492.

RADIAL CLEARANCE

The commonly manufactured double row self-aligning ball bearings have normal radial clearance stated by the manufacturer. For special applications bearings with reduced radial clearance (C2) or with increased radial clearance (C3, C4, C5) can be supplied.

VIBRATION LEVEL

The commonly manufactured double row self-aligning ball bearings have a normal vibration level specified by the manufacturer. For special arrangements demanding for silent operation bearings with reduced vibration level (C6) are supplied.

COMBINATION OF SYMBOLS

The symbols for the tolerance classes, internal bearing clearances and vibration levels are combined with the simultaneous omission of the symbol C in the second and the following bearing special characteristics e. g.:

P6 + C3 = P63 **1206 P63**
C3 + P6 = C36 **1307 C36**

STABILISATION FOR OPERATION AT HIGHER TEMPERATURE

For operating temperature higher than 120 °C specially stabilized double row self-aligning ball bearings with stabilized dimensions for operating temperature from 150 °C to 400 °C (S0, S1, S2, S3, S4,S5) are produced. Delivery of stabilized bearings should be discussed in advance.

MISALIGNMENT

Double row self-aligning ball bearings can accept misalignment of the bearing rings.

Values of permissible misalignment without affecting the correct bearing operation are stated in the following table.

BEARING TYPE	PERMISSIBLE MISALIGNMENT
12, 22	2°30'
126, 13, 23	3°

RADIAL EQUIVALENT DYNAMIC LOAD

$$P_r = F_r + Y_1 F_a \quad \text{for } F_a/F_r \leq e \quad (\text{kN})$$

$$P_r = 0,65 F_r + Y_2 F_a \quad \text{for } F_a/F_r > e \quad (\text{kN})$$

Factor values e, Y1 and Y2 for individual bearings are stated in the table section.

RADIAL EQUIVALENT STATIC LOAD

$$P_{or} = F_r + Y_0 F_a \quad (\text{kN})$$

Factor values Y0 are stated in the table section.

DESIGNATION

The designation of basic designs and common modifications of the bearings is specified in the dimension tables.

Modification of the basic design is indicated by additional symbols according to the norm STN 02 4608.

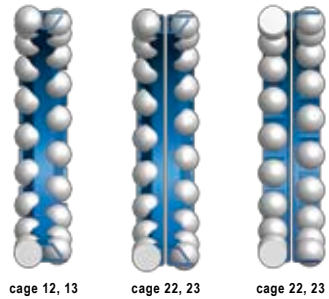

DOUBLE ROW SELF-ALIGNING BALL BEARINGS ZVL SLOVAKIA, a. s.

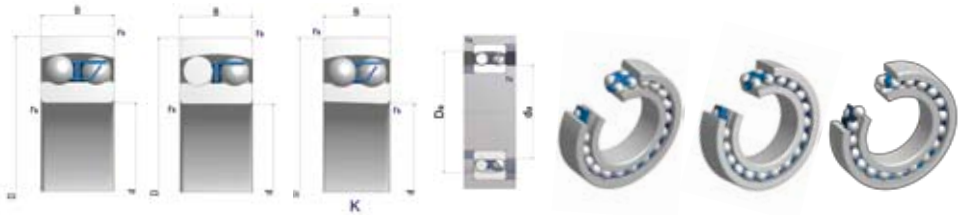

DIMENSIONS mm				BASIC LOAD RATING kN		LIMITING SPEED FOR LUBRICATION min ⁻¹		BEARING DESIGNATION		ABUTMENT AND FILLET DIMENSIONS			WEIGHT kg	CORRESPONDING	COEFFICIENTS				
d	D	B	rs min	C	Co			CYLINDRICAL BORE	TAPERED BORE (1:12)	da max.	Da max.	ra max.	K	ADAPTER SLEEVE	e	Y ₁	Y ₂	Y ₀	
17	40	12	0,6	7,93	2,03	17000	20000	1203	-	12	36	0,6	0,073	-	-	0,31	2,1	3,2	2,2
	47	14	1	9,95	2,66	14000	17000	1204	1204K	25	42	1	0,12	0,118	H204	0,27	2,3	3,6	2,4
25	52	15	1	12,1	3,35	12600	15000	1205	1205K	30	47	1	0,141	0,138	H205	0,27	2,3	3,6	2,4
	52	18	1	12,4	3,48	12600	15000	2205	2205K	30	47	1	0,163	0,158	H305	0,43	1,5	2,3	1,5
	62	17	1,1	17,8	5,01	11000	1300	1305	1305K	31	55	1	0,257	0,252	H305	0,28	2,3	3,5	2,4
	62	24	1,1	24,2	6,56	1000	12000	2305	2305K	31	55	1	0,335	0,327	H2305	0,47	1,3	2,1	1,4
30	62	16	1	15,6	4,73	11000	13000	1206	1206K	35	57	1	0,22	0,216	H206	0,25	2,6	4	2,7
	62	20	1	15,3	4,55	11000	13000	2206	2206K	35	57	1	0,26	0,254	H306	0,4	1,6	2,5	1,7
	72	19	1,1	21,2	6,31	9400	11000	1306	1306K	36	65	1	0,387	0,381	H306	0,26	2,5	3,8	2,6
	72	27	1,1	31,2	8,74	8400	10000	2306	2306K	36	65	1	0,5	0,489	H2306	0,44	1,4	2,2	1,5
35	72	17	1,1	15,9	5,11	9400	11000	1207	1207K	42	65	1	0,323	0,317	H207	0,23	2,7	4,2	2,9
	72	23	1,1	21,6	6,68	9400	11000	2207	2207K	42	65	1	0,403	0,396	H307	0,37	1,7	2,6	1,8
	80	21	1,5	25,1	7,94	7900	9400	1307	1307K	43	72	1,5	0,51	0,502	H307	0,25	2,6	4	2,7
	80	31	1,5	39,7	11,2	7500	8900	2307	2307K	43	72	1,5	0,675	0,665	H2307	0,46	1,4	2,1	1,4
40	80	18	1,1	19	6,56	7900	9400	1208	1208K	46,5	73	1	0,417	0,411	H208	0,22	2,9	4,4	3
	80	23	1,1	22,5	7,36	7900	9400	2208	2208K	46,5	73	1	0,505	0,494	H308	0,33	1,9	2,9	2
	90	23	1,5	29,6	9,81	7100	8400	1308	1308K	47	81	1,5	0,715	0,704	H308	0,24	2,6	4,1	2,7
	90	33	1,5	44,9	13,3	6700	7900	2308	2308K	47	81	1,5	0,925	0,903	H2308	0,43	1,5	2,3	1,5
45	85	19	1,1	21,6	7,36	7500	8900	1209	1209K	52	78	1	0,465	0,459	H209	0,21	3	4,6	3,1
	85	23	1,1	23,4	8,1	7500	8900	2209	2209K	52	78	1	0,545	0,533	H309	0,31	2,1	3,2	2,2
	100	25	1,5	37,7	12,8	6300	7500	1309	1309K	52	91	1,5	0,957	0,942	H309	0,25	2,5	3,9	2,7
	100	36	1,5	54	16,5	6000	7500	2309	2309K	52	91	1,5	1,23	1,2	H2309	0,42	1,5	2,3	1,6

DOUBLE ROW SELF-ALIGNING BALL BEARINGS ZVL SLOVAKIA, a. s.

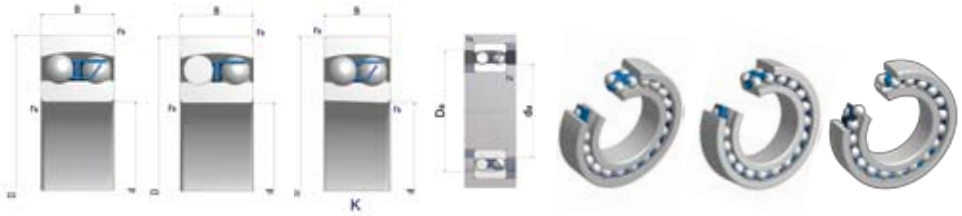

DIMENSIONS mm			BASIC LOAD RATING kN		LIMITING SPEED FOR LUBRICATION min ⁻¹		BEARING DESIGNATION		ABUTMENT AND FILLET DIMENSIONS			WEIGHT kg	CORRESPONDING	COEFFICIENTS					
d	D	B	rs min	C	Co			CYLINDRICAL BORE	TAPERED BORE (1:12)	da max.	Da max.	ra max.	K	ADAPTER SLEEVE	e	Y ₁	Y ₂	Y ₀	
50	90	20	1,1	22,9	8,1	7100	8400	1210	1210K	57	83	1	0,525	0,515	H210	0,2	3,1	4,9	3,3
	90	23	1,1	23,4	8,41	7100	8400	2210	2210K	57	83	1	0,59	0,577	H310	0,29	2,2	3,4	2,3
	110	27	2,1	43,6	14,1	5600	6700	1310	1310K	59	100	2	1,21	1,19	H310	0,24	2,7	4,1	2,8
55	100	21	1,5	26,5	10	6300	7500	1211	1211K	62	91	1,5	0,705	0,693	H211	0,2	3,2	5	3,4
	100	25	1,5	26,5	10	6300	7500	2211	2211K	62	91	1,5	0,81	0,792	H311	0,28	2,3	3,5	2,4
	120	29	2,1	50,7	18,1	5300	6300	1311	1311K	64	111	2	1,58	1,56	H311	0,24	2,7	4,2	2,8
60	120	43	2,1	76,1	23,7	5000	6000	2311	2311K	64	111	2	2,1	2,05	H2311	0,41	1,5	2,4	1,6
	110	22	1,5	30,2	11,7	5600	6700	1212	1212K	67	101	1,5	0,9	0,885	H212	0,19	3,4	5,3	3,6
	110	28	1,5	33,8	12,6	5600	6700	2212	2212K	67	101	1,5	1,09	1,06	H312	0,28	2,3	3,5	2,4
65	130	31	2,1	57,2	20,7	4700	5600	1312	1312K	71	118	2	1,96	1,93	H312	0,23	2,8	4,3	2,9
	130	46	2,1	87,1	28,2	4500	5300	2312	2312K	71	118	2	2,6	2,53	H2312	0,41	1,6	2,4	1,6
	120	23	1,5	31,2	12,3	5300	6300	1213	1213K	72	111	1,5	1,15	1,13	H213	0,17	3,7	5,7	3,9
70	120	31	1,5	43,6	16,5	5300	6300	2213	2213K	72	111	1,5	1,46	1,43	H313	0,28	2,2	3,5	2,3
	140	33	2,1	61,8	22,8	4500	5300	1313	1313K	76	129	2	2,45	2,41	H313	0,23	1,6	2,5	1,7
	140	48	2,1	95,6	32,2	4200	5000	2313	2313K	76	129	2	3,23	3,15	H2313	0,38	1,6	2,5	1,7
75	125	24	1,5	34,5	13,6	5000	6000	1214	-	77	116	1,5	1,26	-	-	0,18	3,5	5,4	3,7
	125	31	1,5	44,2	17,1	5000	6000	2214	-	77	116	1,5	1,52	-	-	0,27	2,4	3,7	2,5
	150	35	2,1	74,1	27,6	4000	4700	1314	-	81	138	2	2,99	-	-	0,22	2,8	4,4	3
75	150	51	2,1	111	37,6	3800	4500	2314	-	81	138	2	3,9	-	-	0,38	1,7	2,6	1,8
	130	25	1,5	39	15,5	4700	5600	1215	1215K	82	121	1,5	1,36	1,34	H215	0,18	3,6	5,6	3,8
	130	31	1,5	44	17,8	4700	5600	2215	2215K	82	121	1,5	1,62	1,58	H315	0,25	2,5	3,9	2,6
80	160	37	2,1	79,3	29,9	3800	4500	1315	1315K	86	148	2	3,56	3,51	H315	0,22	2,8	4,4	3
	160	55	2,1	124	43	2500	4200	2315	2315K	86	148	2	4,72	4,61	H2315	0,38	1,7	2,6	1,7
	140	26	2,1	39,7	16,8	4500	5300	1216	1216K	90	130	2	1,67	1,64	H216	0,16	3,9	6,1	4,1
80	140	33	2,1	48,8	20	4500	5300	2216	2216K	90	130	2	2,01	1,94	H316	0,25	2,5	3,9	2,6
	170	39	2,1	88,4	32,9	3500	4200	1316	1316K	91	159	2	4,18	4,12	H316	0,22	2,9	4,5	3,1
	170	58	2,1	135	48,2	3300	4000	2316	2316K	91	159	2	6,1	5,96	H2316	0,37	1,7	2,6	1,8
85	150	28	2,1	48,8	20,3	4000	4700	1217	1217K	94	140	2	2,07	2,04	H217	0,17	3,7	5,7	3,9
	150	34	2,1	58,5	23,7	4000	4700	2217	2217K	94	140	2	2,52	2,46	H317	0,25	2,5	3,8	2,6
	180	41	3	97,5	37,6	3300	4000	1317	1317K	98	166	2,5	4,98	4,9	H317	0,22	2,9	4,5	3
90	180	60	3	140	51,1	3200	3800	2317	2317K	98	166	2,5	6,71	6,55	H2317	0,37	1,7	2,7	1,7
	160	30	2,1	57,2	23,3	3800	4500	1218	1218K	100	150	2	2,52	2,48	H218	0,17	3,8	5,8	3,9
	160	40	2,1	70,2	28,7	3800	4500	2218	2218K	100	150	2	3,2	3,13	H318	0,27	2,4	3,6	2,5
90	190	43	3	117	44,7	3200	3800	1318	1318K	103	176	2,5	5,8	5,71	H318	0,22	2,8	4,4	3
	190	64	3	153	57,3	3000	3500	2318	2318K	103	176	2,5	7,96	7,77	H2318	0,38	1,7	2,6	1,8
	170	32	2,1	63,7	27,1	3500	4200	1219	1219K	107	158	2	3,1	3,04	H219	0,17	3,7	5,7	3,9
95	170	43	2,1	83,2	34,1	3500	4200	2219	2219K	107	158	2	3,95	3,85	H319	0,27	2,4	3,6	2,5
	200	45	3	133	51,1	3000	3500	1319	1319K	109	186	2,5	6,69	6,59	H319	0,23	2,8	4,3	2,9
	200	67	3	165	64,3	2800	3300	2319	2319K	109	186	2,5	9,21	8,99	H2319	0,38	1,7	2,6	1,8
100	180	34	2,1	68,9	29,3	3300	4000	1220	1220K	112	168	2	3,7	3,64	H220	0,17	3,6	5,6	3,8
	180	46	2,1	97,5	40,6	3300	4000	2220	2220K	112	168	2	4,72	4,61	H320	0,27	2,4	3,6	2,5
	215	47	3	143	58,4	2800	3300	1320	1320K	113	201	2,5	8,3	8,19	H320	0,24	2,7	4,1	2,8
110	215	73	3	190	77,9	2700	3200	2320	2320K	113	201	2,5	11,7	11,4	H2320	0,38	1,7	2,6	1,7
	200	38	2,1	88,4	38,3	3000	3500	1222	1222K	122	188	2	5,15	5,07	H222	0,17	3,6	5,6	3,8
	240	53	2,1	124	52,1	3000	3500	2222	2222K	122	188	2	6,84	6,68	H322	0,28	2,3	3,5	2,4
110	240	55	3	163	70,8	2700	3200	1322	1322K	124	226	2,5	11,8	11,7	H322	0,22	2,8	4,4	3
	240	80	3	216	94,4	2500	3000	2322	2322K	124	226	2,5	17,3	16,9	H2322	0,37	1,7	2,7	1,8
	120	215	42	2,1	119	52,1	2800	3000	1224	-	132	203	2	6,75	-	-	0,19	3,3	5,1
130	230	46	3	126	59,6	2700	3200	1226	-	144	216	2,5	8,3	-	-	0,19	3,3	5	3,4





SINGLE ROW CYLINDRICAL ROLLER BEARINGS

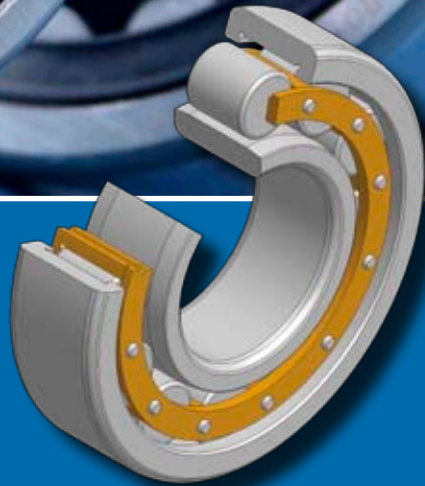

SINGLE ROW CYLINDRICAL ROLLER BEARINGS

Single row cylindrical roller bearings are able to carry large radial load on a relatively small space. Some applications are able to carry also axial load in one or both directions. Raceways of the outer and inner rings together with the sheet profile of the cylindrical rollers in the shape of ZB allow optimal distribution of the contact pressure in the rolling space. This arrangement also allows advantageous formation of lubrication film between the contact parts of the bearing, optimal rolling, decrease of friction, growth of temperature and therefore lower stress of the junction in the arrangement.

At the same time certain mutual misalignment of the rings is allowed and so the bearings cope better with the real operating conditions and contribute to a better reliability and durability during the operating life of the bearings. Cylindrical Roller Bearings are suitable for arrangements, with high requirements for load transfer in connection with high rotation speed, e. g. machine tools, rolling mills, vehicle axle, etc.



DESIGN SPECIFICATIONS

MAIN DIMENSIONS

Main dimensions of cylindrical bearings are specified in the dimension tables and they are in accordance the international standards ISO 15.

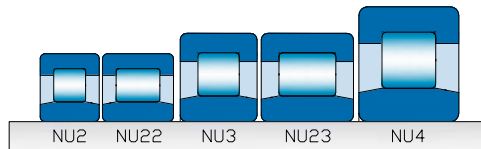

STRUCTURE

Cylindrical roller bearings generally consist of two parts – outer or inner ring block on which with the help of cages and guiding ribs cylindrical rollers are fastened and second, separate ring. This arrangement allows separate mounting of rings and so the manipulation of individual parts is made easier. Through the gradual development and introduction of new possibilities in the materials and processing technologies better utilization of the inner bearing space and introduction of application with higher load marked "E" was enabled. Bearings with steel cage are offered in the whole range with higher load. Higher load bearings with brass cage are dependent on technological possibilities and they are indicated in the table section. Separate group are bearings with brass cage where rib is joined to the cage body by unriveting of cross pieces. This arrangement allows more efficient utilization of inner bearing space and offers better working properties mainly in connection with durability. Designation of these bearings is done by additional letters „EDM“.

THE FOLLOWING CONSTRUCTIONS ARE THE MOST COMMON

NU

The cylindrical rollers are guided by cage between two ribs of outer ring. The inner ring is ribless, which allows mutual bearing rings displacement.

NJ

Similar to NU, but inner ring contains a rib on one side. The bearing can accommodate axial force in one direction.

NUP

The outer ring is manufactured with two ribs, loose inner ring contains solid rib on one side, from the other side is flat angle ring attached. This type of bearings can be used to carry axial forces in both directions.

N

The cylindrical rollers are guided by cage in inner ring with two solid ribs. The outer ring is rib less, relative axial bearing rings displacement is possible.

NF

The inner ring with two solid ribs, outer ring with one guiding rib.

HJ

Angle rings, which use allows to accommodate axial load from needed direction.

Possible combinations of angle ring HJ with bearings:

NJ+HJ, NU+HJ

We do not recommend the combination of NU bearing with two angle rings, because of axial nipping of rollers can occur. The illustration of the combinations is above the table chart.

TOLERANCE

The cylindrical bearings are commonly manufactured within the normal tolerance class P0. Production of bearings with higher tolerance classes is necessary to consult with manufacturer. Limiting values of dimension deviations and operation are stated in the standards ISO 492.

RADIAL CLEARANCE

The commonly manufactured cylindrical bearings are with normal radial clearance or with radial clearance C3. For special applications cylindrical bearings can be supplied with radial clearance C2 (smaller than normal) or with clearance C4, C5 (greater than normal and C3). Radial clearance values are in accordance with the standard ISO 5753. These values are valid for manufactured and unassembled bearing.

STABILISATION FOR OPERATION AT HIGHER TEMPERATURE

For operating temperature higher than 120 °C specially stabilized single row cylindrical roller bearings with stabilized dimensions for operating temperature from 150 °C to 400 °C (S0, S1, S2, S3, S4, S5) are produced. Delivery of stabilized bearings should be discussed in advance.

MISALIGNMENT

The inner construction of area of rolling contact allows the operation of cylindrical bearings with a certain misalignment of both rings

The standard values are:

4' - for bearing series 2, 3

3' - for bearing series 22, 23

CAGE

Cylindrical bearings are generally produced with cages running over the rolling components in following versions:

- E** - pressed steel cage, consisting of 2 ribs and cross pieces, joined by unriveting of pins
- M** - Massive brass cage, which rib is joined to the shell by steel pins
- EM** - similar cage as M, but in construction with higher load
- EDM** - Massive brass cage, where rib is to the cage body joined by unriveting of cross pieces

Delivery of cages in different construction should be discussed in advance.



E



M, EM



EDM



ETNG

EQUIVALENT DYNAMIC LOAD

If cylindrical bearings are used to convey only the radial load rating without the axial load, dynamic load is calculated as follows:

$$P_r = F_r$$

If the cylindrical bearing is subject to simultaneous radial and axial load, the dynamic load is calculated as follows:

$$P = F_r \quad \text{for } F_a/F_r \leq e$$

$$P = 0,92F_r + YF_a \quad \text{for } F_a/F_r > e$$

where

e	= calculation coefficient
e	= 0,2 for bearing series 2, 3, 4
e	= 0,3 for bearing series 22, 23
Y	= axial load coefficient
Y	= 0,6 for bearing series 2, 3, 4
Y	= 0,4 for bearing series 22, 23

For trouble free operation of cylindrical bearings, which convey the axial load, there is important to achieve radial load, where ratio F_a/F_r should not exceed the value 0,5.

EQUIVALENT STATIC LOAD

For static loaded cylindrical bearings is valid:

$$P_p = F_r$$

LIMITING SPEED

The limiting speed specified in the tables section of the catalogue is the maximum number of revolutions acceptable for the bearing to operate trouble-free at a certain level of safety.

DESIGNATION

The designation of basic designs of the bearings is specified in the dimension tables. Modification of the basic design is designated with additional symbols according to STN 02 4608. The meaning of the most used symbols for cylindrical roller bearings is in the table.:

SYMBOL	EXAMPLE	MEANING
M	NU210M	Massive brass cage, with steel pins
E,	NU210E	Bearing with higher basic load ratio and steel cage
EM	NU310EM	Bearing with higher basic load ratio and with steel pins joined brass cage
EDM	NU210EDM	Bearing with higher basic load ratio and brass pin less cage
K	NU210EK	Tapered bore
P6	NU210E P6	Higher tolerance class
C2	NU210E C2	Radial clearance smaller than normal (normal radial clearance is not indicated)
C3	NU210E C3	Radial clearance greater than normal
S1	NU210E S1	Stabilisation of both rings for higher operating temperature

COMBINATION OF SYMBOLS

SYMBOL	EXAMPLE	MEANING
NJ+HJ	NH210E	Bearing NJ with angle ring HJ
P6+C3	NU210E P6C3	Bearing with higher tolerance class than standard and radial clearance greater than normal



SINGLE ROW CYLINDRICAL ROLLER BEARINGS ZVL SLOVAKIA, a. s.

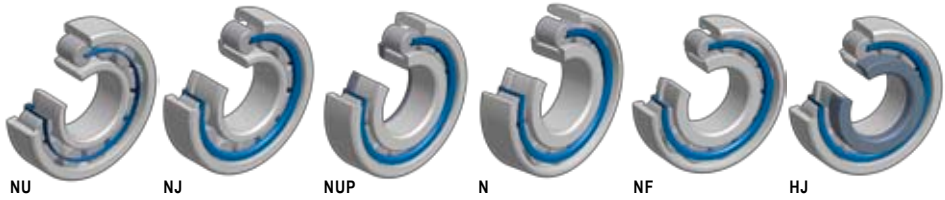

DIMENSIONS mm		BASIC LOAD RATING kN		LIMITING SPEED FOR LUBRICATION min ⁻¹		BEARING DESIGNATION	WEIGHT kg	ANGLE RING		ABUTMENT AND FILLET DIMENSIONS											
d	D	B	rs min.	r1s min.	C		Fw	Ew	da min	da max	Da max	Da min	ra max	rb max	b						
					C ₁₀	C ₀															
17	40	12	0,6	0,3	15,1	11,9	15000	18000	NU203M	0,08	HJ203E	0,008	22,1	-	19	21	36	-	0,6	0,3	3
	40	12	0,6	0,3	15,1	11,9	15000	18000	NJ203M	0,08	HJ203E	0,008	22,1	-	19	21	36	-	0,6	0,3	3
	40	12	0,6	0,3	15,1	11,9	15000	18000	NUP203M	0,08	HJ203E	0,008	22,1	-	19	-	36	-	0,6	0,3	3
	40	12	0,6	0,3	15,1	11,9	15000	18000	N203M	0,08	-	-	-	35,1	19	21	38	37	0,6	0,3	-
	40	12	0,6	0,3	15,1	11,9	15000	18000	NF203M	0,08	-	-	-	35,1	19	21	33	38	0,6	0,3	-
	40	12	0,6	0,3	16,4	13,3	15000	18000	NU203EDM	0,08	HJ203E	0,008	22,1	-	19	21	36	-	0,6	0,3	3
	40	12	0,6	0,3	16,4	13,3	15000	18000	NJ203EDM	0,08	HJ203E	0,008	22,1	-	19	21	36	-	0,6	0,3	3
	40	12	0,6	0,3	16,4	13,3	15000	18000	NUP203EDM	0,08	HJ203E	0,008	22,1	-	19	-	36	-	0,6	0,3	3
	40	12	0,6	0,3	16,4	13,3	15000	18000	N203EDM	0,08	-	-	-	35,1	19	21	38	37	0,6	0,3	-
	40	12	0,6	0,3	16,4	13,3	15000	18000	NF203EDM	0,08	-	-	-	35,1	19	21	33	38	0,6	0,3	-
	40	16	0,6	0,3	21,5	18,8	15000	18000	NJ2203EDM	0,1	HJ2203E	0,008	22,1	-	19	21	36	-	0,6	0,3	3
	40	16	0,6	0,3	21,5	18,8	15000	18000	NUP2203EDM	0,1	HJ2203E	0,008	22,1	-	19	21	36	-	0,6	0,3	3
	40	16	0,6	0,3	21,5	18,8	15000	18000	N2203EDM	0,1	-	-	-	35,1	19	21	38	37	0,6	0,3	-
	40	16	0,6	0,3	21,5	18,8	15000	18000	NF2203EDM	0,1	-	-	-	35,1	19	21	33	38	0,6	0,3	-
	47	14	1	0,6	22,3	17,9	14000	17000	NU303EDM	0,11	HJ303E	0,011	24,2	-	21	23	42	-	1	0,6	3
	47	14	1	0,6	22,3	17,9	14000	17000	NJ303EDM	0,11	HJ303E	0,011	24,2	-	21	23	42	-	1	0,6	3
	47	14	1	0,6	22,3	17,9	14000	17000	NUP303EDM	0,11	-	-	-	40,2	22	38	43	42	1	0,6	-
	47	14	1	0,6	22,3	17,9	14000	17000	NF303EDM	0,11	-	-	-	40,2	22	-	43	42	1	0,6	-
	47	14	1,1	0,6	23,1	19,7	14000	17000	NU204M	0,13	HJ204E	0,011	26,5	-	24	25	42	-	1	0,6	3
	47	14	1,1	0,6	23,1	19,7	14000	17000	NJ204M	0,13	HJ204E	0,011	26,5	-	24	25	42	-	1	0,6	3
	47	14	1,1	0,6	23,1	19,7	14000	17000	NUP204M	0,14	HJ204E	0,011	26,5	-	24	-	42	-	1	0,6	3
	47	14	1,1	0,6	23,1	19,7	14000	17000	N204M	0,13	-	-	-	41,5	25	40	43	43	1	0,6	-
	47	14	1,1	0,6	23,1	19,7	14000	17000	NF204M	0,13	-	-	-	41,5	25	40	43	43	1	0,6	-
	47	14	1,1	0,6	26,9	24,1	14000	17000	NU204EDM	0,13	HJ204E	0,011	26,5	-	24	25	42	-	1	0,6	3
47	14	1,1	0,6	26,9	24,1	14000	17000	NJ204EDM	0,13	HJ204E	0,011	26,5	-	24	25	42	-	1	0,6	3	
47	14	1,1	0,6	26,9	24,1	14000	17000	NUP204EDM	0,14	HJ204E	0,011	26,5	-	24	-	42	-	1	0,6	3	
47	14	1,1	0,6	26,9	24,1	14000	17000	N204EDM	0,13	-	-	-	41,5	25	40	43	43	1	0,6	-	
47	14	1,1	0,6	26,9	24,1	14000	17000	NF204EDM	0,13	-	-	-	41,5	25	40	43	43	1	0,6	-	
47	18	1,1	0,6	30,6	28,3	14000	17000	NU2204EDM	0,13	HJ2204E	0,012	26,5	-	24	25	42	-	1	0,6	3	
47	18	1,1	0,6	30,6	28,3	14000	17000	NJ2204EDM	0,13	HJ2204E	0,012	26,5	-	24	25	42	-	1	0,6	3	
47	18	1,1	0,6	30,6	28,3	14000	17000	NUP2204EDM	0,13	HJ2204E	0,012	26,5	-	24	-	42	-	1	0,6	3	
47	18	1,1	0,6	30,6	28,3	14000	17000	N2204EDM	0,13	-	-	-	41,5	25	40	43	43	1	0,6	-	
47	18	1,1	0,6	30,6	28,3	14000	17000	NF2204EDM	0,13	-	-	-	41,5	25	40	43	43	1	0,6	-	
52	15	1,1	0,6	32,9	28,3	13000	16000	NU304E	0,15	HJ304E	0,017	27,5	-	24	26	45,5	-	1	0,6	4	
52	15	1,1	0,6	32,9	28,3	13000	16000	NJ304E	0,15	HJ304E	0,017	27,5	-	24	29	46,5	-	1	0,6	4	
52	15	1,1	0,6	32,9	28,3	13000	16000	NUP304E	0,15	HJ304E	0,017	27,5	-	24	-	47,5	-	1	0,6	4	
52	15	1,1	0,6	32,9	28,3	13000	16000	N304E	0,15	-	-	-	45,5	26,5	44	48	47	1	0,6	-	
52	15	1,1	0,6	32,9	28,3	13000	16000	NF304E	0,15	-	-	-	45,5	26,5	44	48	47	1	0,6	-	
52	15	1,1	0,6	32,9	28,3	13000	16000	NU204EDM	0,15	HJ304E	0,017	27,5	-	24	26	45,5	-	1	0,6	4	
52	15	1,1	0,6	32,9	28,3	13000	16000	NJ304EDM	0,15	HJ304E	0,017	27,5	-	24	29	46,5	-	1	0,6	4	
52	15	1,1	0,6	32,9	28,3	13000	16000	NUP304EDM	0,15	HJ304E	0,017	27,5	-	24	-	47,5	-	1	0,6	4	
52	15	1,1	0,6	32,9	28,3	13000	16000	N304EDM	0,15	-	-	-	45,5	26,5	44	48	47	1	0,6	-	
52	15	1,1	0,6	32,9	28,3	13000	16000	NF304EDM	0,15	-	-	-	45,5	26,5	44	48	47	1	0,6	-	
52	21	1,1	0,6	43,2	40,3	13000	16000	NU2304E	0,21	HJ2304E	0,018	27,5	-	24	26	45,5	-	1	0,6	4	
52	21	1,1	0,6	43,2	40,3	13000	16000	NJ2304E	0,22	HJ2304E	0,018	27,5	-	24	29	46,5	-	1	0,6	4	
52	21	1,1	0,6	43,2	40,3	13000	16000	NUP2304E	0,22	HJ2304E	0,018	27,5	-	24	-	47,5	-	1	0,6	4	
52	21	1,1	0,6	43,2	40,3	13000	16000	N2304E	0,21	-	-	-	45,5	26,5	44	48	47	1	0,6	-	
52	21	1,1	0,6	43,2	40,3	13000	16000	NF2304E	0,22	-	-	-	45,5	26,5	44	48	47	1	0,6	-	
52	21	1,1	0,6	43,2	40,3	13000	16000	NU2304EDM	0,22	HJ2304E	0,018	27,5	-	24	26	45,5	-	1	0,6	4	
52	21	1,1	0,6	43,2	40,3	13000	16000	NJ2304EDM	0,22	HJ2304E	0,018	27,5	-	24	29	46,5	-	1	0,6	4	
52	21	1,1	0,6	43,2	40,3	13000	16000	NUP2304EDM	0,23	HJ2304E	0,018	27,5	-	24	-	47,5	-	1	0,6	4	
52	21	1,1	0,6	43,2	40,3	13000	16000	N2304EDM	0,22	-	-	-	45,5	26,5	44	48	47	1	0,6	-	
52	21	1,1	0,6	43,2	40,3	13000	16000	NF2304EDM	0,22	-	-	-	45,5	26,5	44	48	47	1	0,6	-	



SINGLE ROW CYLINDRICAL ROLLER BEARINGS ZVL SLOVAKIA, a. s.

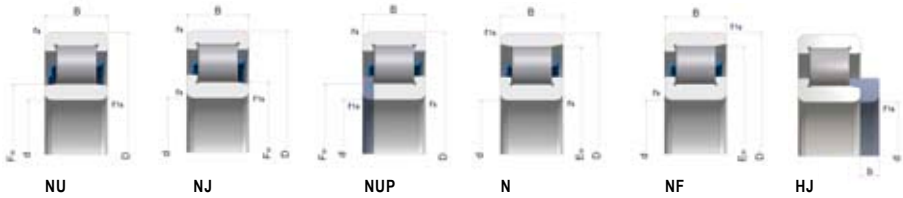

DIMENSIONS mm				BASIC LOAD RATING kN		LIMITING SPEED FOR LUBRICATION min ⁻¹		BEARING DESIGNATION	WEIGHT kg	ANGLE RING		ABUTMENT AND FILLET DIMENSIONS										
d	D	B	rs min.	r1s min.	C		Co						Fw	Ew	da	da	Da	Da	ra	rb	b	
					min	max	min	max							min	max	min	max	min	max		
25	52	15	1,1	0,6	28,9	27,2	12500	15000	NU205E	0,15	HJ205E	0,014	31,5	-	29	30	47	-	1	0,6	3	
	52	15	1,1	0,6	28,9	27,2	12500	15000	NJ205E	0,15	HJ205E	0,014	31,5	-	29	30	47	-	1	0,6	3	
	52	15	1,1	0,6	28,9	27,2	12500	15000	NUP205E	0,16	HJ205E	0,014	31,5	-	29	-	47	-	1	0,6	3	
	52	15	1,1	0,6	28,9	27,2	12500	15000	N205E	0,15	-	-	-	46,5	30	45	48	48	1	0,6	-	
	52	15	1,1	0,6	28,9	27,2	12500	15000	NF205E	0,15	-	-	-	46,5	30	45	48	48	1	0,6	-	
	52	15	1,1	0,6	28,9	27,2	12500	15000	NU205EDM	0,15	HJ205E	0,014	31,5	-	29	30	47	-	1	0,6	3	
	52	15	1,1	0,6	28,9	27,2	12500	15000	NJ205EDM	0,15	HJ205E	0,014	31,5	-	29	30	47	-	1	0,6	3	
	52	15	1,1	0,6	28,9	27,2	12500	15000	NUP205EDM	0,16	HJ205E	0,014	31,5	-	29	-	47	-	1	0,6	3	
	52	15	1,1	0,6	28,9	27,2	12500	15000	N205EDM	0,15	-	-	-	46,5	30	45	48	48	1	0,6	-	
	52	15	1,1	0,6	28,9	27,2	12500	15000	NF205EDM	0,15	-	-	-	46,5	30	45	48	48	1	0,6	-	
	52	18	1,1	0,6	32,6	32	12500	15000	NU2205E	0,21	HJ2205E	0,014	31,5	-	29	30	47	-	1	0,6	3	
	52	18	1,1	0,6	32,6	32	12500	15000	NJ2205E	0,21	HJ2205E	0,014	31,5	-	29	30	47	-	1	0,6	3	
	52	18	1,1	0,6	32,6	32	12500	15000	NUP2205E	0,22	HJ2205E	0,014	31,5	-	29	-	47	-	1	0,6	3	
	52	18	1,1	0,6	32,6	32	12500	15000	N2205E	0,2	-	-	-	46,5	30	45	48	48	1	0,6	-	
	52	18	1,1	0,6	32,6	32	12500	15000	NF2205E	0,21	-	-	-	46,5	30	45	48	48	1	0,6	-	
	52	18	1,1	0,6	32,6	32	12500	15000	NU2205EDM	0,22	HJ2205E	0,014	31,5	-	29	30	47	-	1	0,6	3	
	52	18	1,1	0,6	32,6	32	12500	15000	NJ2205EDM	0,23	HJ2205E	0,014	31,5	-	29	30	47	-	1	0,6	3	
	52	18	1,1	0,6	32,6	32	12500	15000	NUP2205EDM	0,25	HJ2205E	0,014	31,5	-	29	-	47	-	1	0,6	3	
	52	18	1,1	0,6	32,6	32	12500	15000	N2205EDM	0,22	-	-	-	46,5	30	45	48	48	1	0,6	-	
	52	18	1,1	0,6	32,6	32	12500	15000	NF2205EDM	0,23	-	-	-	46,5	30	45	48	48	1	0,6	-	
	62	17	1,1	1,1	41,6	37,4	10000	12000	HJ305E	0,24	HJ305E	0,023	34	-	31,5	32	55,5	-	1	1	4	
	62	17	1,1	1,1	41,6	37,4	10000	12000	NJ305E	0,24	HJ305E	0,023	34	-	31,5	32	55,5	-	1	1	4	
	62	17	1,1	1,1	41,6	37,4	10000	12000	NUP305E	0,26	HJ305E	0,023	34	-	31,5	-	55,5	-	1	1	4	
	62	17	1,1	1,1	41,6	37,4	10000	12000	N305E	0,24	-	-	-	54	31,5	52	56	56	1	1	-	
	62	17	1,1	1,1	41,6	37,4	10000	12000	NF305E	0,24	-	-	-	54	31,5	52	56	56	1	1	-	
	62	17	1,1	1,1	41,6	37,4	10000	12000	NU305EDM	0,25	HJ305E	0,023	34	-	31,5	32	55,5	-	1	1	4	
	62	17	1,1	1,1	41,6	37,4	10000	12000	NJ305EDM	0,25	HJ305E	0,023	34	-	31,5	32	55,5	-	1	1	4	
	62	17	1,1	1,1	41,6	37,4	10000	12000	NUP305EDM	0,27	HJ305E	0,023	34	-	31,5	-	55,5	-	1	1	4	
	62	17	1,1	1,1	41,6	37,4	10000	12000	N305EDM	0,25	HJ305E	-	-	54	31,5	52	56	56	1	1	-	
	62	17	1,1	1,1	41,6	37,4	10000	12000	NF305EDM	0,25	-	-	-	54	31,5	52	56	56	1	1	-	
	62	24	1,1	1,1	57	56,1	10000	12000	NU2305E	0,3	HJ2305E	0,025	34	-	31,5	32	55,5	-	1	1	4	
	62	24	1,1	1,1	57	56,1	10000	12000	NJ2305E	0,3	HJ2305E	0,025	34	-	31,5	32	55,5	-	1	1	4	
	62	24	1,1	1,1	57	56,1	10000	12000	NUP2305E	0,32	HJ2305E	0,025	34	-	31,5	-	55,5	-	1	1	4	
	62	24	1,1	1,1	57	56,1	10000	12000	N2305E	0,3	-	-	-	54	31,5	52	56	56	1	1	-	
	62	24	1,1	1,1	57	56,1	10000	12000	NF2305E	0,3	-	-	-	54	31,5	52	56	56	1	1	-	
	62	24	1,1	1,1	57	56,1	10000	12000	NU2305EDM	0,34	HJ2305E	0,025	34	-	31,5	32	55,5	-	1	1	4	
	62	24	1,1	1,1	57	56,1	10000	12000	NJ2305EDM	0,34	HJ2305E	0,025	34	-	31,5	32	55,5	-	1	1	4	
	62	24	1,1	1,1	57	56,1	10000	12000	NUP2305EDM	0,36	HJ2305E	0,025	34	-	31,5	-	55,5	-	1	1	4	
	62	24	1,1	1,1	57	56,1	10000	12000	N2305EDM	0,34	-	-	-	54	31,5	52	56	56	1	1	-	
	62	24	1,1	1,1	57	56,1	10000	12000	NF2305EDM	0,34	-	-	-	54	31,5	52	56	56	1	1	-	
	80	21	1,5	1,5	54,1	46,5	8500	10000	NU405M	0,56	HJ405	0,63	39,5	-	36	38	67	-	1	1	6	
	80	21	1,5	1,5	54,1	46,5	8500	10000	NJ405M	0,56	HJ405	0,63	39,5	-	36	38	67	-	1	1	6	
	80	21	1,5	1,5	54,1	46,5	8500	10000	NUP405M	0,58	HJ405	0,63	39,5	-	36	-	67	-	1	1	6	
	80	21	1,5	1,5	54,1	46,5	8500	10000	N405M	0,56	-	-	-	65,5	36	63	68	68	1	1	-	
	80	21	1,5	1,5	54,1	46,5	8500	10000	NF405M	0,56	-	-	-	65,5	36	63	68	68	1	1	-	
	30	62	16	1,1	0,6	40,8	39,4	10000	12000	NU206E	0,2	HJ206E	0,025	37,5	-	34	36	57	-	1	0,6	4
		62	16	1,1	0,6	40,8	39,4	10000	12000	NJ206E	0,21	HJ206E	0,025	37,5	-	34	36	57	-	1	0,6	4
		62	16	1,1	0,6	40,8	39,4	10000	12000	NUP206E	0,22	HJ206E	0,025	37,5	-	34	-	57	-	1	0,6	4
62		16	1,1	0,6	40,8	39,4	10000	12000	N206E	0,2	-	-	-	55,5	35	54	58	57	1	0,6	-	
62		16	1,1	0,6	40,8	39,4	10000	12000	NF206E	0,2	-	-	-	55,5	35	54	58	57	1	0,6	-	
62		16	1,1	0,6	40,8	39,4	10000	12000	NU206EDM	0,23	HJ206E	0,025	37,5	-	34	36	57	-	1	0,6	4	
62	16	1,1	0,6	40,8	39,4	10000	12000	NJ206EDM	0,24	HJ206E	0,025	37,5	-	34	36	57	-	1	0,6	4		
62	16	1,1	0,6	40,8	39,4	10000	12000	NUP206EDM	0,25	HJ206E	0,025	37,5	-	34	-	57	-	1	0,6	4		

SINGLE ROW CYLINDRICAL ROLLER BEARINGS ZVL SLOVAKIA, a. s.

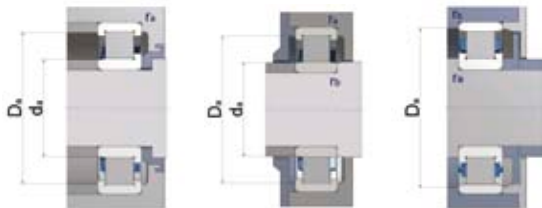

DIMENSIONS mm					BASIC LOAD RATING kN		LIMITING SPEED FOR LUBRICATION min ⁻¹		BEARING DESIGNATION	WEIGHT kg	ANGLE RING			ABUTMENT AND FILLET DIMENSIONS							
d	D	B	rs min.	r1s min.	C	Co					Fw	Ew	da	da	Da	Da	ra	rb	b		
													min	max	max	min	max	max			
30	62	16	1,1	0,6	40,8	39,4	10000	12000	N206EDM	0,23	-	-	55,5	35	54	58	57	1	0,6	-	
	62	16	1,1	0,6	40,8	39,4	10000	12000	NF206EDM	0,24	-	-	55,5	35	54	58	57	1	0,6	-	
	62	20	1,1	0,6	48,9	49,8	10000	12000	NU2206E	0,26	HJ2206E	0,028	37,5	-	34	36	57	-	1	0,6	4
	62	20	1,1	0,6	48,9	49,8	10000	12000	NJ2206E	0,26	HJ2206E	0,028	37,5	-	34	36	57	-	1	0,6	4
	62	20	1,1	0,6	48,9	49,8	10000	12000	NUP2206E	0,27	HJ2206E	0,028	37,5	-	34	-	57	-	1	0,6	4
	62	20	1,1	0,6	48,9	49,8	10000	12000	N2206E	0,26	-	-	55,5	35	54	58	57	1	0,6	-	
	62	20	1,1	0,6	48,9	49,8	10000	12000	NF2206E	0,26	-	-	55,5	35	54	58	57	1	0,6	-	
	62	20	1,1	0,6	46,1	46	10000	12000	NU2206EDM	0,27	HJ2206E	0,028	37,5	-	34	36	57	-	1	0,6	4
	62	20	1,1	0,6	46,1	46	10000	12000	NJ2206EDM	0,027	HJ2206E	0,028	37,5	-	34	36	57	-	1	0,6	4
	62	20	1,1	0,6	46,1	46	10000	12000	NUP2206EDM	0,28	HJ2206E	0,028	37,5	-	34	-	57	-	1	0,6	4
	62	20	1,1	0,6	46,1	46	10000	12000	N2206EDM	0,27	-	-	55,5	35	54	58	57	1	0,6	-	
	62	20	1,1	0,6	46,1	46	10000	12000	NF2206EDM	0,27	-	-	55,5	35	54	58	57	1	0,6	-	
	72	19	1,1	1,1	53,2	50,2	8400	10000	NJ306E	0,36	HJ306E	0,04	40,5	-	36,5	39	65,5	-	1	1	5
	72	19	1,1	1,1	53,2	50,2	8400	10000	NJ306E	0,36	HJ306E	0,04	40,5	-	36,5	39	65,5	-	1	1	5
	72	19	1,1	1,1	53,2	50,2	8400	10000	NUP306E	0,38	HJ306E	0,04	40,5	-	36,5	-	65,5	-	1	1	5
	72	19	1,1	1,1	53,2	50,2	8400	10000	N306E	0,36	-	-	62,5	36,5	60	65,5	64	1	1	-	
	72	19	1,1	1,1	53,2	50,2	8400	10000	NF306E	0,36	-	-	62,5	36,5	60	65,5	64	1	1	-	
	72	19	1,1	1,1	53,2	50,2	8400	10000	NU306EDM	0,37	HJ306E	0,04	40,5	-	36,5	39	65,5	-	1	1	5
	72	19	1,1	1,1	53,2	50,2	8400	10000	NJ306EDM	0,37	HJ306E	0,04	40,5	-	36,5	39	65,5	-	1	1	5
	72	19	1,1	1,1	53,2	50,2	8400	10000	NUP306EDM	0,39	HJ306E	0,04	40,5	-	36,5	-	65,5	-	1	1	5
	72	19	1,1	1,1	53,2	50,2	8400	10000	N306EDM	0,37	-	-	62,5	36,5	60	65,5	64	1	1	-	
	72	19	1,1	1,1	53,2	50,2	8400	10000	NF306EDM	0,37	-	-	62,5	36,5	60	65,5	64	1	1	-	
	72	27	1,1	1,1	65,1	64,7	9000	10500	HJ2306M	0,53	HJ2306E	0,042	40,5	-	36,5	39	65,5	-	1	1	5
	72	27	1,1	1,1	65,1	64,7	9000	10500	NJ2306M	0,54	HJ2306E	0,042	40,5	-	36,5	39	65,5	-	1	1	5
	72	27	1,1	1,1	65,1	64,7	9000	10500	NUP2306M	0,55	HJ2306E	0,042	40,5	-	36,5	-	65,5	-	1	1	5
	72	27	1,1	1,1	65,1	64,7	9000	10500	N2306M	0,53	-	-	62,5	36,5	60	65,5	64	1	1	-	
	72	27	1,1	1,1	65,1	64,7	9000	10500	NF2306M	0,54	-	-	62,5	36,5	60	65,5	64	1	1	-	
	72	27	1,1	1,1	72,9	75,3	9000	10500	HJ2306E	0,53	HJ2306E	0,042	40,5	-	36,5	39	65,5	-	1	1	5
	72	27	1,1	1,1	72,9	75,3	9000	10500	NJ2306E	0,54	HJ2306E	0,042	40,5	-	36,5	39	65,5	-	1	1	5
	72	27	1,1	1,1	72,9	75,3	9000	10500	NUP2306E	0,55	HJ2306E	0,042	40,5	-	36,5	-	65,5	-	1	1	5
	72	27	1,1	1,1	72,9	75,3	9000	10500	N2306E	0,53	-	-	62,5	36,5	60	65,5	64	1	1	-	
	72	27	1,1	1,1	72,9	75,3	9000	10500	NF2306E	0,54	-	-	62,5	36,5	60	65,5	64	1	1	-	
	72	27	1,1	1,1	72,9	75,3	9000	10500	NU2306EDM	0,53	HJ2306E	0,042	40,5	-	36,5	39	65,5	-	1	1	5
	72	27	1,1	1,1	72,9	75,3	9000	10500	NJ2306EDM	0,54	HJ2306E	0,042	40,5	-	36,5	39	65,5	-	1	1	5
	72	27	1,1	1,1	72,9	75,3	9000	10500	NUP2306EDM	0,55	HJ2306E	0,042	40,5	-	36,5	-	65,5	-	1	1	5
	72	27	1,1	1,1	72,9	75,3	9000	10500	N2306EDM	0,53	-	-	62,5	36,5	60	65,5	64	1	1	-	
	72	27	1,1	1,1	72,9	75,3	9000	10500	NF2306EDM	0,54	-	-	62,5	36,5	60	65,5	64	1	1	-	
	90	23	1,5	1,5	66,4	59,2	7100	8400	NU406M	0,8	HJ406	0,081	45	-	38	47	82	-	1,5	1,5	7
	90	23	1,5	1,5	66,4	59,2	7100	8400	NJ406M	0,81	HJ406	0,081	45	-	38	47	82	-	1,5	1,5	7
	90	23	1,5	1,5	66,4	59,2	7100	8400	NUP406M	0,83	HJ406	0,081	45	-	38	47	82	-	1,5	1,5	7
90	23	1,5	1,5	66,4	59,2	7100	8400	N406M	0,8	-	-	73	38	-	77	75	1,5	1,5	-		
90	23	1,5	1,5	66,4	59,2	7100	8400	NF406M	0,81	-	-	73	38	71	77	75	1,5	1,5	-		
35	72	17	1,1	0,6	47,5	46,6	8600	10000	NU207E	0,3	HJ207E	0,033	44	-	39	42	65,5	-	1	0,6	4
	72	17	1,1	0,6	47,5	46,6	8600	10000	NJ207E	0,3	HJ207E	0,033	44	-	39	42	65,5	-	1	0,6	4
	72	17	1,1	0,6	47,5	46,6	8600	10000	NUP207E	0,31	HJ207E	0,033	44	-	39	-	65,5	-	1	0,6	4
	72	17	1,1	0,6	47,5	46,6	8600	10000	N207E	0,3	-	-	64	41,5	62	68	66	1	0,6	-	
	72	17	1,1	0,6	47,5	46,6	8600	10000	NF207E	0,3	-	-	64	41,5	62	68	66	1	0,6	-	
	72	17	1,1	0,6	47,5	46,6	8600	10000	NU207EDM	0,3	HJ207E	0,033	44	-	39	42	65,5	-	1	0,6	4
	72	17	1,1	0,6	47,5	46,6	8600	10000	NJ207EDM	0,3	HJ207E	0,033	44	-	39	42	65,5	-	1	0,6	4
	72	17	1,1	0,6	47,5	46,6	8600	10000	NUP207EDM	0,31	HJ207E	0,033	44	-	39	42	65,5	-	1	0,6	4
	72	17	1,1	0,6	47,5	46,6	8600	10000	N207EDM	0,3	-	-	64	41,5	-	68	66	1	0,6	-	
	72	17	1,1	0,6	47,5	46,6	8600	10000	NF207EDM	0,3	-	-	64	41,5	-	68	66	1	0,6	-	
	72	23	1,1	0,6	61,6	65,3	8600	10000	NU2207E	0,4	HJ2207E	0,036	44	-	39	42	65,5	-	1	0,6	4
	72	23	1,1	0,6	61,6	65,3	8600	10000	NJ2207E	0,4	HJ2207E	0,036	44	-	39	42	65,5	-	1	0,6	4

SINGLE ROW CYLINDRICAL ROLLER BEARINGS ZVL SLOVAKIA, a. s.

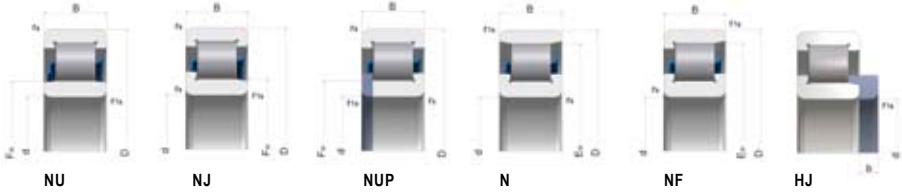

d	DIMENSIONS mm					BASIC LOAD RATING kN		LIMITING SPEED FOR LUBRICATION min ⁻¹	BEARING DESIGNATION	WEIGHT kg	ANGLE RING		ABUTMENT AND FILLET DIMENSIONS								
	D	B	rs min.	r1s min.	C	Co	Fw				Ew	da min	da max	Da min	Da max	ra min	ra max	rb	b		
35	72	23	1,1	0,6	61,6	65,3	8600	10000	NUP2207E	0,41	HJ2207E	0,036	44	-	39	42	65,5	-	1	0,6	4
	72	23	1,1	0,6	61,6	65,3	8600	10000	N2207E	0,4	-	-	-	64	41,5	-	68	66	1	0,6	-
	72	23	1,1	0,6	61,6	65,3	8600	10000	NF2207E	0,4	-	-	-	64	41,5	62	68	66	1	0,6	-
	72	23	1,1	0,6	58,3	60,1	8600	10000	NU2207EDM	0,42	HJ2207E	0,036	44	-	39	42	65,5	-	1	0,6	4
	72	23	1,1	0,6	58,3	60,1	8600	10000	NJ2207EDM	0,42	HJ2207E	0,036	44	-	39	42	65,5	-	1	0,6	4
	72	23	1,1	0,6	58,3	60,1	8600	10000	NUP2207EDM	0,45	HJ2207E	0,036	44	-	39	42	65,5	-	1	0,6	4
	72	23	1,1	0,6	58,3	60,1	8600	10000	N2207EDM	0,42	-	-	-	64	41,5	-	68	66	1	0,6	-
	72	23	1,1	0,6	58,3	60,1	8600	10000	NF2207EDM	0,42	-	-	-	64	41,5	62	68	66	1	0,6	-
	80	21	1,5	1,1	66,6	65,4	7900	9400	NU307E	0,49	HJ307E	0,058	46,2	-	41,5	44	72	-	1,5	1	6
	80	21	1,5	1,1	66,6	65,4	7900	9400	NJ307E	0,49	HJ307E	0,058	46,2	-	41,5	44	72	-	1,5	1	6
	80	21	1,5	1,1	66,6	65,4	7900	9400	NUP307E	0,51	HJ307E	0,058	46,2	-	41,5	44	72	-	1,5	1	6
	80	21	1,5	1,1	66,6	65,4	7900	9400	N307E	0,49	-	-	-	70,2	43	-	73,5	72	1,5	1	-
	80	21	1,5	1,1	66,6	65,4	7900	9400	NF307E	0,49	-	-	-	70,2	43	68	73,5	72	1,5	1	-
	80	21	1,5	1,1	62,4	60	7900	9400	NU307EM	0,52	HJ307E	0,058	46,2	-	41,5	44	72	-	1,5	1	6
	80	21	1,5	1,1	62,4	60	7900	9400	NJ307EM	0,52	HJ307E	0,058	46,2	-	41,5	44	72	-	1,5	1	6
	80	21	1,5	1,1	62,4	60	7900	9400	NUP307EM	0,54	HJ307E	0,058	46,2	-	41,5	44	72	-	1,5	1	6
	80	21	1,5	1,1	62,4	60	7900	9400	N307EM	0,52	-	-	-	70,2	43	-	73,5	72	1,5	1	-
	80	21	1,5	1,1	62,4	60	7900	9400	NF307EM	0,52	-	-	-	70,2	43	68	73,5	72	1,5	1	-
	80	21	1,5	1,1	66,6	65,4	7900	9400	NU307EDM	0,52	HJ307E	0,058	46,2	-	41,5	44	72	-	1,5	1	6
	80	21	1,5	1,1	66,6	65,4	7900	9400	NJ307EDM	0,52	HJ307E	0,058	46,2	-	41,5	44	72	-	1,5	1	6
	80	21	1,5	1,1	66,6	65,4	7900	9400	NUP307EDM	0,54	HJ307E	0,058	46,2	-	41,5	44	72	-	1,5	1	6
	80	21	1,5	1,1	66,6	65,4	7900	9400	N307EDM	0,52	-	-	-	70,2	43	-	73,5	72	1,5	1	-
	80	21	1,5	1,1	66,6	65,4	7900	9400	NF307EDM	0,52	-	-	-	70,2	43	68	73,5	72	1,5	1	-
	80	31	1,5	1,1	83,9	87,6	7900	9400	NU2307M	0,73	HJ2307E	0,062	46,2	-	41,5	44	72	-	1,5	1	6
	80	31	1,5	1,1	83,9	87,6	7900	9400	NJ2307M	0,73	HJ2307E	0,062	46,2	-	41,5	44	72	-	1,5	1	6
	80	31	1,5	1,1	83,9	87,6	7900	9400	NUP2307M	0,75	HJ2307E	0,062	46,2	-	41,5	44	72	-	1,5	1	6
	80	31	1,5	1,1	83,9	87,6	7900	9400	N2307M	0,73	-	-	-	70,2	43	-	73,5	72	1,5	1	-
	80	31	1,5	1,1	83,9	87,6	7900	9400	NF2307M	0,73	-	-	-	70,2	43	68	73,5	72	1,5	1	-
	80	31	1,5	1,1	91	98	7100	8400	NU2307E	0,71	HJ2307E	0,062	46,2	-	41,5	44	72	-	1,5	1	6
	80	31	1,5	1,1	91	98	7100	8400	NJ2307E	0,71	HJ2307E	0,062	46,2	-	41,5	44	72	-	1,5	1	6
	80	31	1,5	1,1	91	98	7100	8400	NUP2307E	0,73	HJ2307E	0,062	46,2	-	41,5	44	72	-	1,5	1	6
	80	31	1,5	1,1	91	98	7100	8400	N2307E	0,71	-	-	-	70,2	43	-	73,5	72	1,5	1	-
	80	31	1,5	1,1	91	98	7100	8400	NF2307E	0,71	-	-	-	70,2	43	68	73,5	72	1,5	1	-
	80	31	1,5	1,1	91	98	7100	8400	NU2307EDM	0,73	HJ2307E	0,062	46,2	-	41,5	44	72	-	1,5	1	6
	80	31	1,5	1,1	91	98	7100	8400	NJ2307EDM	0,73	HJ2307E	0,062	46,2	-	41,5	44	72	-	1,5	1	6
	80	31	1,5	1,1	91	98	7100	8400	NUP2307EDM	0,75	HJ2307E	0,062	46,2	-	41,5	44	72	-	1,5	1	6
	80	31	1,5	1,1	91	98	7100	8400	N2307EDM	0,73	-	-	-	70,2	43	-	73,5	72	1,5	1	-
	80	31	1,5	1,1	91	98	7100	8400	NF2307EDM	0,73	-	-	-	70,2	43	68	73,5	72	1,5	1	-
	100	25	1,5	1,5	77,6	72	6400	7500	NU407M	1,1	HJ407	0,13	53	-	43	50	92	-	1,5	1,5	8
	100	25	1,5	1,5	77,6	72	6400	7500	NJ407M	1,1	HJ407	0,13	53	-	43	50	92	-	1,5	1,5	8
100	25	1,5	1,5	77,6	72	6400	7500	NUP407M	1,3	HJ407	0,13	53	-	43	50	92	-	1,5	1,5	8	
100	25	1,5	1,5	77,6	72	6400	7500	N407M	1,1	-	-	-	83	49	-	86	85	1,5	1,5	-	
100	25	1,5	1,5	77,6	72	6400	7500	NF407M	1,1	-	-	-	83	49	79	86	85	1,5	1,5	-	
40	80	18	1,1	1,1	55,7	55,4	7500	9200	NU208E	0,38	HJ208E	0,047	49,5	-	46,5	48	73,5	-	1	1	5
	80	18	1,1	1,1	55,7	55,4	7500	9200	NJ208E	0,38	HJ208E	0,047	49,5	-	46,5	48	73,5	-	1	1	5
	80	18	1,1	1,1	55,7	55,4	7500	9200	NUP208E	0,39	HJ208E	0,047	49,5	-	46,5	48	73,5	-	1	1	5
	80	18	1,1	1,1	55,7	55,4	7500	9200	N208E	0,38	-	-	-	71,5	46,5	-	73,5	73	1	1	-
	80	18	1,1	1,1	55,7	55,4	7500	9200	NF208E	0,38	-	-	-	71,5	46,5	69	73,5	73	1	1	-
	80	18	1,1	1,1	55,7	55,4	7500	9200	NU208EDM	0,39	HJ208E	0,047	49,5	-	46,5	48	73,5	-	1	1	5
	80	18	1,1	1,1	55,7	55,4	7500	9200	NJ208EDM	0,39	HJ208E	0,047	49,5	-	46,5	48	73,5	-	1	1	5
	80	18	1,1	1,1	55,7	55,4	7500	9200	NUP208EDM	0,41	HJ208E	0,047	49,5	-	46,5	48	73,5	-	1	1	5
	80	18	1,1	1,1	55,7	55,4	7500	9200	N208EDM	0,39	-	-	-	71,5	46,5	-	73,5	73	1	1	-
	80	18	1,1	1,1	55,7	55,4	7500	9200	NF208EDM	0,39	-	-	-	71,5	46,5	69	73,5	73	1	1	-
	80	23	1,1	1,1	64,4	66,5	7400	9100	NU2208M	0,51	HJ2208E	0,048	49,5	-	46,5	48	73,5	-	1	1	5

SINGLE ROW CYLINDRICAL ROLLER BEARINGS ZVL SLOVAKIA, a. s.

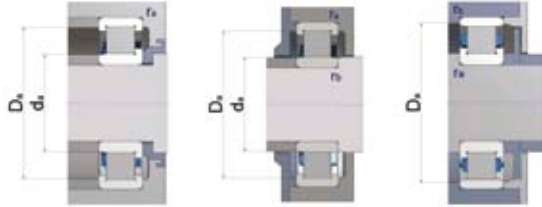

DIMENSIONS mm					BASIC LOAD RATING kN		LIMITING SPEED FOR LUBRICATION min ⁻¹		BEARING DESIGNATION	WEIGHT kg	ANGLE RING		ABUTMENT AND FILLET DIMENSIONS								
d	D	B	rs min.	r1s min.	C		Co		Fw	Ew	da min	da max	Da max	Da min	ra max	rb max	b				
					min.	max.	min.	max.													
40	80	23	1,1	1,1	64,4	66,5	7400	9100	NJ2208M	0,51	HJ2208E	0,048	49,5	-	46,5	48	73,5	-	1	1	5
	80	23	1,1	1,1	64,4	66,5	7400	9100	NUP2208M	0,53	HJ2208E	0,048	49,5	-	46,5	48	73,5	-	1	1	5
	80	23	1,1	1,1	64,4	66,5	7400	9100	N2208M	0,51	-	-	71,5	46,5	-	73,5	73	1	1	-	-
	80	23	1,1	1,1	64,4	66,5	7400	9100	NF2208M	0,51	-	-	71,5	46,5	69	73,5	73	1	1	-	-
	80	23	1,1	1,1	72,3	77,6	7400	9100	NJ2208E	0,5	HJ2208E	0,048	49,5	-	46,5	48	73,5	-	1	1	5
	80	23	1,1	1,1	72,3	77,6	7400	9100	NJ2208E	0,5	HJ2208E	0,048	49,5	-	46,5	48	73,5	-	1	1	5
	80	23	1,1	1,1	72,3	77,6	7400	9100	NUP2208E	0,51	HJ2208E	0,048	49,5	-	46,5	48	73,5	-	1	1	5
	80	23	1,1	1,1	72,3	77,6	7400	9100	N2208E	0,5	-	-	71,5	46,5	-	73,5	73	1	1	-	-
	80	23	1,1	1,1	72,3	77,6	7400	9100	NF2208E	0,5	-	-	71,5	46,5	69	73,5	73	1	1	-	-
	80	23	1,1	1,1	72,3	77,6	7400	9100	NJ2208EDM	0,51	HJ2208E	0,048	49,5	-	46,5	48	73,5	-	1	1	5
	80	23	1,1	1,1	72,3	77,6	7400	9100	NJ2208EDM	0,51	HJ2208E	0,048	49,5	-	46,5	48	73,5	-	1	1	5
	80	23	1,1	1,1	72,3	77,6	7400	9100	NUP2208EDM	0,53	HJ2208E	0,048	49,5	-	46,5	48	73,5	-	1	1	5
	80	23	1,1	1,1	72,3	77,6	7400	9100	N2208EDM	0,51	-	-	71,5	46,5	-	73,5	73	1	1	-	-
	80	23	1,1	1,1	72,3	77,6	7400	9100	NF2208EDM	0,51	-	-	71,5	46,5	69	73,5	73	1	1	-	-
	90	23	1,5	1,5	81,5	83,2	6700	8000	NJ308E	0,69	HJ308E	0,084	52	-	48	50	82	-	1,5	1,5	7
	90	23	1,5	1,5	81,5	83,2	6700	8000	NJ308E	0,7	HJ308E	0,084	52	-	48	50	82	-	1,5	1,5	7
	90	23	1,5	1,5	81,5	83,2	6700	8000	NUP308E	0,72	HJ308E	0,084	52	-	48	50	82	-	1,5	1,5	7
	90	23	1,5	1,5	81,5	83,2	6700	8000	N308E	0,69	-	-	80	48	-	82	82	1,5	1,5	-	-
	90	23	1,5	1,5	81,5	83,2	6700	8000	NF308E	0,7	-	-	80	48	78	82	82	1,5	1,5	-	-
	90	23	1,5	1,5	77,9	74,7	6700	8000	NJ308EM	0,7	HJ308E	0,084	52	-	48	50	82	-	1,5	1,5	7
	90	23	1,5	1,5	77,9	74,7	6700	8000	NJ308EM	0,71	HJ308E	0,084	52	-	48	50	82	-	1,5	1,5	7
	90	23	1,5	1,5	77,9	74,7	6700	8000	NUP308EM	0,73	HJ308E	0,084	52	-	48	50	82	-	1,5	1,5	7
	90	23	1,5	1,5	77,9	74,7	6700	8000	N308EM	0,7	-	-	80	48	-	82	82	1,5	1,5	-	-
	90	23	1,5	1,5	77,9	74,7	6700	8000	NF308EM	0,71	-	-	80	48	78	82	82	1,5	1,5	-	-
	90	23	1,5	1,5	81,5	83,2	6700	8000	NJ308EDM	0,7	HJ308E	0,084	52	-	48	50	82	-	1,5	1,5	7
	90	23	1,5	1,5	81,5	83,2	6700	8000	NJ308EDM	0,71	HJ308E	0,084	52	-	48	50	82	-	1,5	1,5	7
	90	23	1,5	1,5	81,5	83,2	6700	8000	NUP308EDM	0,73	HJ308E	0,084	52	-	48	50	82	-	1,5	1,5	7
	90	23	1,5	1,5	81,5	83,2	6700	8000	N308EDM	0,7	-	-	80	48	-	82	82	1,5	1,5	-	-
	90	23	1,5	1,5	81,5	83,2	6700	8000	NF308EDM	0,71	-	-	80	48	78	82	82	1,5	1,5	-	-
	90	33	1,5	1,5	111,6	119,4	6300	7400	NJ2308E	0,95	HJ2308E	0,088	52	-	48	50	82	-	1,5	1,5	7
	90	33	1,5	1,5	111,6	119,4	6300	7400	NJ2308E	0,95	HJ2308E	0,088	52	-	48	50	82	-	1,5	1,5	7
	90	33	1,5	1,5	111,6	119,4	6300	7400	NUP2308E	0,98	HJ2308E	0,088	52	-	48	50	82	-	1,5	1,5	7
	90	33	1,5	1,5	111,6	119,4	6300	7400	N2308E	0,95	-	-	80	48	-	82	82	1,5	1,5	-	-
	90	33	1,5	1,5	111,6	119,4	6300	7400	NF2308E	0,95	-	-	80	48	78	82	82	1,5	1,5	-	-
	90	33	1,5	1,5	111,6	119,4	6300	7400	NJ2308EDM	1	HJ2308E	0,088	52	-	48	50	82	-	1,5	1,5	7
	90	33	1,5	1,5	111,6	119,4	6300	7400	NJ2308EDM	1,1	HJ2308E	0,088	52	-	48	50	82	-	1,5	1,5	7
	90	33	1,5	1,5	111,6	119,4	6300	7400	NUP2308EDM	1,3	HJ2308E	0,088	52	-	48	50	82	-	1,5	1,5	7
	90	33	1,5	1,5	111,6	119,4	6300	7400	N2308EDM	1	-	-	80	48	-	82	82	1,5	1,5	-	-
	90	33	1,5	1,5	111,6	119,4	6300	7400	NF2308EDM	1,1	-	-	80	48	78	82	82	1,5	1,5	-	-
	110	27	2,1	2,1	106	101,8	5600	6700	NJ408M	1,41	HJ408	0,14	58	-	49	56	101	-	2	2	8
110	27	2,1	2,1	106	101,8	5600	6700	NJ408M	1,42	HJ408	0,14	58	-	49	56	101	-	2	2	8	
110	27	2,1	2,1	106	101,8	5600	6700	NUP408M	1,43	HJ408	0,14	58	-	49	56	101	-	2	2	8	
110	27	2,1	2,1	106	101,8	5600	6700	N408M	1,41	-	-	92	49	-	94	94	2	2	-	-	
110	27	2,1	2,1	106	101,8	5600	6700	NF408M	1,42	-	-	92	49	90	94	94	2	2	-	-	
45	85	19	1,1	1,1	56,6	57,6	7500	8800	NU209M	0,46	HJ209E	0,052	54,5	-	51,5	53	78,5	-	1	1	5
	85	19	1,1	1,1	56,6	57,6	7500	8800	NJ209M	0,46	HJ209E	0,052	54,5	-	51,5	53	78,5	-	1	1	5
	85	19	1,1	1,1	56,6	57,6	7500	8800	NUP209M	0,48	HJ209E	0,052	54,5	-	51,5	53	78,5	-	1	1	5
	85	19	1,1	1,1	56,6	57,6	7500	8800	N209M	0,46	-	-	76,5	51,5	-	78,5	78	1	1	-	-
	85	19	1,1	1,1	56,6	57,6	7500	8800	NF209M	0,46	-	-	76,5	51,5	74	78,5	78	1	1	-	-
	85	19	1,1	1,1	63,1	66,5	7500	8800	NJ209E	0,44	HJ209E	0,052	54,5	-	51,5	53	78,5	-	1	1	5
	85	19	1,1	1,1	63,1	66,5	7500	8800	NJ209E	0,44	HJ209E	0,052	54,5	-	51,5	53	78,5	-	1	1	5
	85	19	1,1	1,1	63,1	66,5	7500	8800	NUP209E	0,46	HJ209E	0,052	54,5	-	51,5	53	78,5	-	1	1	5
	85	19	1,1	1,1	63,1	66,5	7500	8800	N209E	0,44	-	-	76,5	51,5	-	78,5	78	1	1	-	-
	85	19	1,1	1,1	63,1	66,5	7500	8800	NF209E	0,44	-	-	76,5	51,5	74	78,5	78	1	1	-	-

SINGLE ROW CYLINDRICAL ROLLER BEARINGS ZVL SLOVAKIA, a. s.

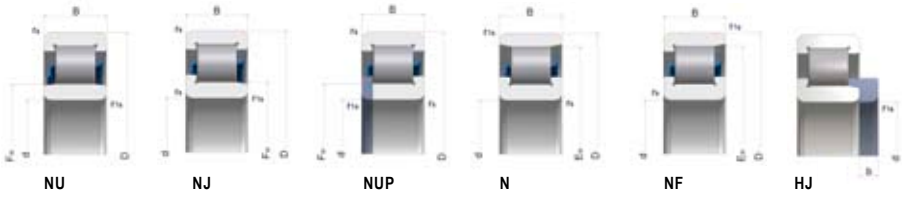

DIMENSIONS mm					BASIC LOAD RATING kN		LIMITING SPEED FOR LUBRICATION min ⁻¹		BEARING DESIGNATION	WEIGHT kg	ANGLE RING		ABUTMENT AND FILLET DIMENSIONS								
d	D	B	rs min.	r1s min.	C		Co		C	Co	Fw	Ew	da min	da max	Da max	Da min	ra max	rb max	b		
					C	Co	C	Co													
45	85	19	1,1	1,1	63,1	66,5	7500	8800	NJ209EDM	0,46	HJ209E	0,052	54,5	-	51,5	53	78,5	-	1	1	5
	85	19	1,1	1,1	63,1	66,5	7500	8800	NJ209EDM	0,46	HJ209E	0,052	54,5	-	51,5	53	78,5	-	1	1	5
	85	19	1,1	1,1	63,1	66,5	7500	8800	NUP209EDM	0,48	HJ209E	0,052	54,5	-	51,5	53	78,5	-	1	1	5
	85	19	1,1	1,1	63,1	66,5	7500	8800	N209EDM	0,46	-	-	-	76,5	51,5	-	78,5	78	1	1	-
	85	19	1,1	1,1	63,1	66,5	7500	8800	NF209EDM	0,46	-	-	-	76,5	51,5	74	78,5	78	1	1	-
	85	23	1,1	1,1	76	84,6	7200	8400	NJ2209E	0,54	HJ2209E	0,053	54,5	-	51,5	53	78,5	-	1	1	5
	85	23	1,1	1,1	76	84,6	7200	8400	NJ2209E	0,54	HJ2209E	0,053	54,5	-	51,5	53	78,5	-	1	1	5
	85	23	1,1	1,1	76	84,6	7200	8400	NUP2209E	0,56	HJ2209E	0,053	54,5	-	51,5	53	78,5	-	1	1	5
	85	23	1,1	1,1	76	84,6	7200	8400	N2209E	0,54	-	-	-	76,5	51,5	-	78,5	78	1	1	-
	85	23	1,1	1,1	76	84,6	7200	8400	NJ2209E	0,54	-	-	-	76,5	51,5	74	78,5	78	1	1	-
	85	23	1,1	1,1	76	84,6	7200	8400	NJ2209EDM	0,56	HJ2209E	0,053	54,5	-	51,5	53	78,5	-	1	1	5
	85	23	1,1	1,1	76	84,6	7200	8400	NJ2209EDM	0,56	HJ2209E	0,053	54,5	-	51,5	53	78,5	-	1	1	5
	85	23	1,1	1,1	76	84,6	7200	8400	NUP2209EDM	0,58	HJ2209E	0,053	54,5	-	51,5	53	78,5	-	1	1	5
	85	23	1,1	1,1	76	84,6	7200	8400	N2209EDM	0,56	-	-	-	76,5	51,5	-	78,5	78	1	1	-
	85	23	1,1	1,1	76	84,6	7200	8400	NF2209EDM	0,56	-	-	-	76,5	51,5	74	78,5	78	1	1	-
	100	25	1,5	1,5	88,7	86,7	6400	7500	NJ309M	0,97	HJ309E	0,11	58,5	-	53	56	92	-	1,5	1,5	7
	100	25	1,5	1,5	88,7	86,7	6400	7500	NJ309M	0,97	HJ309E	0,11	58,5	-	53	56	92	-	1,5	1,5	7
	100	25	1,5	1,5	88,7	86,7	6400	7500	NUP309M	1	HJ309E	0,11	58,5	-	53	56	92	-	1,5	1,5	7
	100	25	1,5	1,5	88,7	86,7	6400	7500	N309M	0,97	-	-	-	88,5	53	-	92	91	1,5	1,5	-
	100	25	1,5	1,5	88,7	86,7	6400	7500	NF309M	0,97	-	-	-	88,5	53	86	92	91	1,5	1,5	-
	100	25	1,5	1,5	94,7	94,6	6400	7500	NJ309E	0,95	HJ309E	0,11	58,5	-	53	56	92	-	1,5	1,5	7
	100	25	1,5	1,5	94,7	94,6	6400	7500	NJ309E	0,95	HJ309E	0,11	58,5	-	53	56	92	-	1,5	1,5	7
	100	25	1,5	1,5	94,7	94,6	6400	7500	NUP309E	0,98	HJ309E	0,11	58,5	-	53	56	92	-	1,5	1,5	7
	100	25	1,5	1,5	94,7	94,6	6400	7500	N309E	0,95	-	-	-	88,5	53	-	92	91	1,5	1,5	-
	100	25	1,5	1,5	94,7	94,6	6400	7500	NF309E	0,95	-	-	-	88,5	53	86	92	91	1,5	1,5	-
	100	25	1,5	1,5	94,7	94,6	6400	7500	NJ309EDM	0,97	HJ309E	0,11	58,5	-	53	56	92	-	1,5	1,5	7
	100	25	1,5	1,5	94,7	94,6	6400	7500	NJ309EDM	0,97	HJ309E	0,11	58,5	-	53	56	92	-	1,5	1,5	7
	100	25	1,5	1,5	94,7	94,6	6400	7500	NUP309EDM	1	HJ309E	0,11	58,5	-	53	56	92	-	1,5	1,5	7
	100	25	1,5	1,5	94,7	94,6	6400	7500	N309EDM	0,97	-	-	-	88,5	53	-	92	91	1,5	1,5	-
	100	25	1,5	1,5	94,7	94,6	6400	7500	NF309EDM	0,97	-	-	-	88,5	53	86	92	91	1,5	1,5	-
	100	36	1,5	1,5	119,5	127	5600	6700	NJ2309M	1,3	HJ2309E	0,11	58,5	-	53	56	92	-	1,5	1,5	7
	100	36	1,5	1,5	119,5	127	5600	6700	NJ2309M	1,3	HJ2309E	0,11	58,5	-	53	56	92	-	1,5	1,5	7
	100	36	1,5	1,5	119,5	127	5600	6700	NUP2309M	1,5	HJ2309E	0,11	58,5	-	53	56	92	-	1,5	1,5	7
	100	36	1,5	1,5	119,5	127	5600	6700	N2309M	1,3	-	-	-	88,5	53	-	92	91	1,5	1,5	-
	100	36	1,5	1,5	119,5	127	5600	6700	NF2309M	1,3	-	-	-	88,5	53	86	92	91	1,5	1,5	-
	100	36	1,5	1,5	137,2	153	5600	6700	NJ2309E	1,1	HJ2309E	0,11	58,5	-	53	56	92	-	1,5	1,5	7
	100	36	1,5	1,5	137,2	153	5600	6700	NJ2309E	1,1	HJ2309E	0,11	58,5	-	53	56	92	-	1,5	1,5	7
	100	36	1,5	1,5	137,2	153	5600	6700	NUP2309E	1,3	HJ2309E	0,11	58,5	-	53	56	92	-	1,5	1,5	7
	100	36	1,5	1,5	137,2	153	5600	6700	N2309E	1,1	-	-	-	88,5	53	-	92	91	1,5	1,5	-
	100	36	1,5	1,5	137,2	153	5600	6700	NF2309E	1,1	-	-	-	88,5	53	86	92	91	1,5	1,5	-
100	36	1,5	1,5	137,2	153	5600	6700	NJ2309EDM	1,3	HJ2309E	0,11	58,5	-	53	56	92	-	1,5	1,5	7	
100	36	1,5	1,5	137,2	153	5600	6700	NJ2309EDM	1,3	HJ2309E	0,11	58,5	-	53	56	92	-	1,5	1,5	7	
100	36	1,5	1,5	137,2	153	5600	6700	NUP2309EDM	1,5	HJ2309E	0,11	58,5	-	53	56	92	-	1,5	1,5	7	
100	36	1,5	1,5	137,2	153	5600	6700	N2309EDM	1,3	-	-	-	88,5	53	-	92	91	1,5	1,5	-	
100	36	1,5	1,5	137,2	153	5600	6700	NF2309EDM	1,3	-	-	-	88,5	53	86	92	91	1,5	1,5	-	
120	29	2,1	2,1	118,4	115,7	5400	6500	NJ409M	1,65	HJ409	0,18	64,5	-	54	62	111	-	2	2	8	
120	29	2,1	2,1	118,4	115,7	5400	6500	NJ409M	1,65	HJ409	0,18	64,5	-	54	62	111	-	2	2	8	
120	29	2,1	2,1	118,4	115,7	5400	6500	NUP409M	1,7	HJ409	0,18	64,5	-	54	62	111	-	2	2	8	
120	29	2,1	2,1	118,4	115,7	5400	6500	N409M	1,65	-	-	-	100,5	54	-	104	104	2	2	-	
120	29	2,1	2,1	118,4	115,7	5400	6500	NF409M	1,65	-	-	-	100,5	54	98	104	104	2	2	-	
50	90	20	1,1	1,1	59,7	62,9	6400	7600	NJ210M	0,52	HJ210	0,058	59,5	-	56,5	57	83,5	-	1	1	5
	90	20	1,1	1,1	59,7	62,9	6400	7600	NJ210M	0,52	HJ210	0,058	59,5	-	56,5	57	83,5	-	1	1	5
	90	20	1,1	1,1	59,7	62,9	6400	7600	NUP210M	0,54	HJ210	0,058	59,5	-	56,5	57	83,5	-	1	1	5
	90	20	1,1	1,1	59,7	62,9	6400	7600	N210M	0,52	-	-	-	81,5	56,5	-	83,5	84	1	1	-

SINGLE ROW CYLINDRICAL ROLLER BEARINGS ZVL SLOVAKIA, a. s.

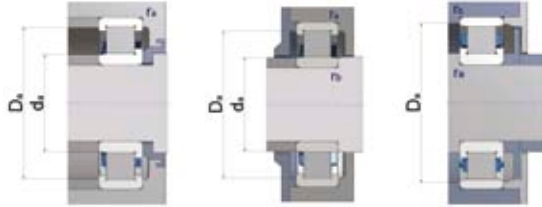

DIMENSIONS mm					BASIC LOAD RATING kN		LIMITING SPEED FOR LUBRICATION min ⁻¹		BEARING DESIGNATION	WEIGHT kg	ANGLE RING		ABUTMENT AND FILLET DIMENSIONS								
d	D	B	rs min.	r1s min.	C		Co		Fw	Ew	da min	da max	Da max	Da min	ra max	rb max	b				
					C	Co	C	Co													
50	90	20	1,1	1,1	59,7	62,9	6400	7600	NF210M	0,52	-	-	-	81,5	56,5	79	83,5	84	1	1	-
	90	20	1,1	1,1	66	71,9	6400	7600	HJ210E	0,058	59,5	-	56,5	57	83,5	-	1	1	5	-	
	90	20	1,1	1,1	66	71,9	6400	7600	NJ210E	0,49	59,5	-	56,5	57	83,5	-	1	1	5	-	
	90	20	1,1	1,1	66	71,9	6400	7600	NUP210E	0,51	HJ210E	0,058	59,5	-	56,5	57	83,5	-	1	1	5
	90	20	1,1	1,1	66	71,9	6400	7600	N210E	0,49	-	-	-	81,5	56,5	-	83,5	84	1	1	-
	90	20	1,1	1,1	66	71,9	6400	7600	NF210E	0,49	-	-	-	81,5	56,5	79	83,5	84	1	1	-
	90	20	1,1	1,1	66	71,9	6400	7600	HJ210E	0,058	59,5	-	56,5	57	83,5	-	1	1	5	-	
	90	20	1,1	1,1	66	71,9	6400	7600	NJ210EDM	0,52	HJ210E	0,058	59,5	-	56,5	57	83,5	-	1	1	5
	90	20	1,1	1,1	66	71,9	6400	7600	NUP210EDM	0,54	HJ210E	0,058	59,5	-	56,5	57	83,5	-	1	1	5
	90	20	1,1	1,1	66	71,9	6400	7600	N210EDM	0,52	-	-	-	81,5	56,5	-	83,5	84	1	1	-
	90	20	1,1	1,1	66	71,9	6400	7600	NF210EDM	0,52	-	-	-	81,5	56,5	79	83,5	84	1	1	-
	90	23	1,1	1,1	79,5	91,5	6300	7500	HJ2210E	0,058	59,5	-	56,5	57	83,5	-	1	1	5	-	
	90	23	1,1	1,1	79,5	91,5	6300	7500	NJ2210E	0,58	HJ2210E	0,058	59,5	-	56,5	57	83,5	-	1	1	5
	90	23	1,1	1,1	79,5	91,5	6300	7500	NUP2210E	0,6	HJ2210E	0,058	59,5	-	56,5	57	83,5	-	1	1	5
	90	23	1,1	1,1	79,5	91,5	6300	7500	N2210E	0,58	-	-	-	81,5	56,5	-	83,5	84	1	1	-
	90	23	1,1	1,1	79,5	91,5	6300	7500	NF2210E	0,58	-	-	-	81,5	56,5	79	83,5	84	1	1	-
	90	23	1,1	1,1	79,5	91,5	6300	7500	NJ2210EDM	0,59	HJ2210E	0,058	59,5	-	56,5	57	83,5	-	1	1	5
	90	23	1,1	1,1	79,5	91,5	6300	7500	NUP2210EDM	0,059	HJ2210E	0,058	59,5	-	56,5	57	83,5	-	1	1	5
	90	23	1,1	1,1	79,5	91,5	6300	7500	N2210EDM	0,61	HJ2210E	0,058	59,5	-	56,5	57	83,5	-	1	1	5
	90	23	1,1	1,1	79,5	91,5	6300	7500	NF2210EDM	0,59	-	-	-	81,5	56,5	-	83,5	84	1	1	-
	90	23	1,1	1,1	79,5	91,5	6300	7500	NJ2210EDM	0,59	-	-	-	81,5	56,5	79	83,5	84	1	1	-
	110	27	2,1	2,1	119	124,9	5200	6100	HJ310E	1,2	HJ310E	0,14	65	-	59	63	101	-	2	2	8
	110	27	2,1	2,1	119	124,9	5200	6100	NJ310E	1,21	HJ310E	0,14	65	-	59	63	101	-	2	2	8
	110	27	2,1	2,1	119	124,9	5200	6100	NUP310E	1,23	HJ310E	0,14	65	-	59	63	101	-	2	2	8
	110	27	2,1	2,1	119	124,9	5200	6100	N310E	1,2	-	-	-	97	59	-	101	99	2	2	-
	110	27	2,1	2,1	119	124,9	5200	6100	NF310E	1,21	-	-	-	97	59	95	101	99	2	2	-
	110	27	2,1	2,1	112	115	5200	6100	NJ310EM	1,25	HJ310E	0,14	65	-	59	63	101	-	2	2	8
	110	27	2,1	2,1	112	115	5200	6100	NUP310EM	1,26	HJ310E	0,14	65	-	59	63	101	-	2	2	8
	110	27	2,1	2,1	112	115	5200	6100	N310EM	1,28	HJ310E	0,14	65	-	59	63	101	-	2	2	8
	110	27	2,1	2,1	112	115	5200	6100	NF310EM	1,25	-	-	-	97	59	-	101	99	2	2	-
	110	27	2,1	2,1	112	115	5200	6100	NJ310EM	1,25	-	-	-	97	59	95	101	99	2	2	-
	110	27	2,1	2,1	119	124,9	5200	6100	NUS310EDM	1,25	HJ310E	0,14	65	-	59	63	101	-	2	2	8
	110	27	2,1	2,1	119	124,9	5200	6100	NJ310EDM	1,26	HJ310E	0,14	65	-	59	63	101	-	2	2	8
	110	27	2,1	2,1	119	124,9	5200	6100	NUP310EDM	1,28	HJ310E	0,14	65	-	59	63	101	-	2	2	8
	110	27	2,1	2,1	119	124,9	5200	6100	N310EDM	1,25	-	-	-	97	59	-	101	99	2	2	-
	110	27	2,1	2,1	119	124,9	5200	6100	NF310EDM	1,25	-	-	-	97	59	95	101	99	2	2	-
	110	40	2,1	2,1	151,1	169,5	5100	6100	HJ2310	1,82	HJ2310	0,15	65	-	59	63	101	-	2	2	8
	110	40	2,1	2,1	151,1	169,5	5100	6100	NJ2310	1,83	HJ2310	0,15	65	-	59	63	101	-	2	2	8
	110	40	2,1	2,1	151,1	169,5	5100	6100	NUP2310M	1,85	HJ2310	0,15	65	-	59	63	101	-	2	2	8
	110	40	2,1	2,1	151,1	169,5	5100	6100	N2310M	1,82	-	-	-	97	59	-	101	99	2	2	-
	110	40	2,1	2,1	151,1	169,5	5100	6100	NF2310M	1,83	-	-	-	97	59	95	101	99	2	2	-
	110	40	2,1	2,1	161	184	5100	6100	HJ2310E	1,77	HJ2310E	0,15	65	-	59	63	101	-	2	2	8
	110	40	2,1	2,1	161	184	5100	6100	NJ2310E	1,78	HJ2310E	0,15	65	-	59	63	101	-	2	2	8
	110	40	2,1	2,1	161	184	5100	6100	NUP2310E	1,8	HJ2310E	0,15	65	-	59	63	101	-	2	2	8
	110	40	2,1	2,1	161	184	5100	6100	N2310E	1,77	-	-	-	97	59	-	101	99	2	2	-
	110	40	2,1	2,1	161	184	5100	6100	NF2310E	1,78	-	-	-	97	59	95	101	99	2	2	-
	110	40	2,1	2,1	161	184	5100	6100	HJ2310EDM	1,82	HJ2310E	0,15	65	-	59	63	101	-	2	2	8
	110	40	2,1	2,1	161	184	5100	6100	NJ2310EDM	1,83	HJ2310E	0,15	65	-	59	63	101	-	2	2	8
110	40	2,1	2,1	161	184	5100	6100	NUP2310EDM	1,85	HJ2310E	0,15	65	-	59	63	101	-	2	2	8	
110	40	2,1	2,1	161	184	5100	6100	N2310EDM	1,82	-	-	-	97	59	-	101	99	2	2	-	
110	40	2,1	2,1	161	184	5100	6100	NF2310EDM	1,83	-	-	-	97	59	95	101	99	2	2	-	
130	31	2,1	2,1	138,6	135,9	4800	5600	NJ410M	2	HJ410	0,23	70,8	-	61	68	119	-	2	2	9	
130	31	2,1	2,1	138,6	135,9	4800	5600	NJ410M	2	HJ410	0,23	70,8	-	61	68	119	-	2	2	9	
130	31	2,1	2,1	138,6	135,9	4800	5600	NUP410M	2,05	HJ410	0,23	70,8	-	61	68	119	-	2	2	9	



SINGLE ROW CYLINDRICAL ROLLER BEARINGS ZVL SLOVAKIA, a. s.

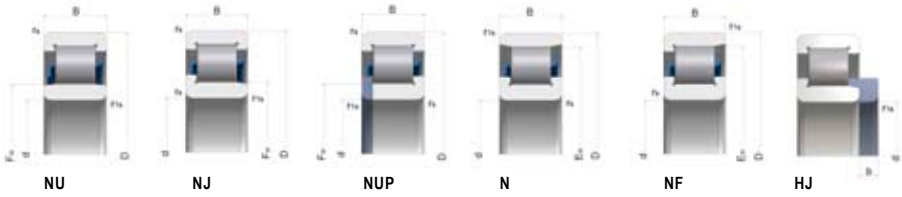

DIMENSIONS mm					BASIC LOAD RATING kN		LIMITING SPEED FOR LUBRICATION min ⁻¹		BEARING DESIGNATION	WEIGHT kg	ANGLE RING			ABUTMENT AND FILLET DIMENSIONS							
d	D	B	rs min.	r1s min.	C	Co	5600	7200	N410M	2	-	-	Fw	Ew	da	da	Da	ra	rb	b	
															min	max	min	max	max		min
50	130	31	2,1	2,1	138,6	135,9	4800	5600	N410M	2	-	-	-	140,5	61	-	119	117	2	2	-
	130	31	2,1	2,1	138,6	135,9	4800	5600	NF410M	2	-	-	-	140,5	61	137	119	117	-	-	-
55	100	21	1,5	1,1	82,5	92,9	6300	7200	NU211E	0,66	HJ211E	0,083	66	-	61,5	64	92	-	1,5	1	6
	100	21	1,5	1,1	82,5	92,9	6300	7200	NJ211E	0,67	HJ211E	0,083	66	-	61,5	64	92	-	1,5	1	6
	100	21	1,5	1,1	82,5	92,9	6300	7200	NUP211E	0,69	HJ211E	0,083	66	-	61,5	64	92	-	1,5	1	6
	100	21	1,5	1,1	82,5	92,9	6300	7200	N211E	0,66	-	-	90	63	-	93,5	92	1,5	1	-	
	100	21	1,5	1,1	82,5	92,9	6300	7200	NF211E	0,67	-	-	90	63	88	93,5	92	1,5	1	-	
	100	21	1,5	1,1	82,5	92,9	6300	7200	NU211EDM	0,69	HJ211E	0,083	66	-	61,5	64	92	-	1,5	1	6
	100	21	1,5	1,1	82,5	92,9	6300	7200	NJ211EDM	0,7	HJ211E	0,083	66	-	61,5	64	92	-	1,5	1	6
	100	21	1,5	1,1	82,5	92,9	6300	7200	NUP211EDM	0,72	HJ211E	0,083	66	-	61,5	64	92	-	1,5	1	6
	100	21	1,5	1,1	82,5	92,9	6300	7200	N211EDM	0,69	-	-	90	63	-	93,5	92	1,5	1	-	
	100	21	1,5	1,1	82,5	92,9	6300	7200	NF211EDM	0,7	-	-	90	63	88	93,5	92	1,5	1	-	
	100	25	1,5	1,1	101,4	121,5	6300	7200	NU2211E	0,79	HJ2211E	0,085	66	-	61,5	64	92	-	1,5	1	6
	100	25	1,5	1,1	101,4	121,5	6300	7200	NJ2211E	0,8	HJ2211E	0,085	66	-	61,5	64	92	-	1,5	1	6
	100	25	1,5	1,1	101,4	121,5	6300	7200	NUP2211E	0,82	HJ2211E	0,085	66	-	61,5	64	92	-	1,5	1	6
	100	25	1,5	1,1	101,4	121,5	6300	7200	N2211E	0,79	-	-	90	63	-	93,5	92	1,5	1	-	
	100	25	1,5	1,1	101,4	121,5	6300	7200	NF2211E	0,8	-	-	90	63	88	93,5	92	1,5	1	-	
	100	25	1,5	1,1	96,9	114,4	6300	7200	NU2211EDM	0,82	HJ2211E	0,085	66	-	61,5	64	92	-	1,5	1	6
	100	25	1,5	1,1	96,9	114,4	6300	7200	NJ2211EDM	0,83	HJ2211E	0,085	66	-	61,5	64	92	-	1,5	1	6
	100	25	1,5	1,1	96,9	114,4	6300	7200	NUP2211EDM	0,85	HJ2211E	0,085	66	-	61,5	64	92	-	1,5	1	6
	100	25	1,5	1,1	96,9	114,4	6300	7200	N2211EDM	0,82	-	-	90	63	-	93,5	92	1,5	1	-	
	100	25	1,5	1,1	96,9	114,4	6300	7200	NF2211EDM	0,83	-	-	90	63	88	93,5	92	1,5	1	-	
	120	29	2,1	2,1	141	147,6	5200	6300	NU311E	1,45	HJ311E	0,19	70,5	-	64	68	111	-	2	2	9
	120	29	2,1	2,1	141	147,6	5200	6300	NJ311E	1,5	HJ311E	0,19	70,5	-	64	68	111	-	2	2	9
	120	29	2,1	2,1	141	147,6	5200	6300	NUP311E	1,55	HJ311E	0,19	70,5	-	64	68	111	-	2	2	9
	120	29	2,1	2,1	141	147,6	5200	6300	N311E	1,45	-	-	106,5	64	-	111	109	2	2	-	
	120	29	2,1	2,1	141	147,6	5200	6300	NF311E	1,15	-	-	106,5	64	104	111	109	2	2	-	
	120	29	2,1	2,1	132,7	136,3	5200	6300	NU311EM	1,5	HJ311E	0,19	70,5	-	64	68	111	-	2	2	9
	120	29	2,1	2,1	132,7	136,3	5200	6300	NJ311EM	1,55	HJ311E	0,19	70,5	-	64	68	111	-	2	2	9
	120	29	2,1	2,1	132,7	136,3	5200	6300	NUP311EM	1,6	HJ311E	0,19	70,5	-	64	68	111	-	2	2	9
	120	29	2,1	2,1	132,7	136,3	5200	6300	N311EM	1,5	-	-	106,5	64	-	111	109	2	2	-	
	120	29	2,1	2,1	132,7	136,3	5200	6300	NF311EM	1,55	-	-	106,5	64	104	111	109	2	2	-	
	120	29	2,1	2,1	141	147,6	5200	6300	NU311EDM	1,5	HJ311E	0,19	70,5	-	64	68	111	-	2	2	9
	120	29	2,1	2,1	141	147,6	5200	6300	NJ311EDM	1,55	HJ311E	0,19	70,5	-	64	68	111	-	2	2	9
	120	29	2,1	2,1	141	147,6	5200	6300	NUP311EDM	1,6	HJ311E	0,19	70,5	-	64	68	111	-	2	2	9
	120	29	2,1	2,1	141	147,6	5200	6300	N311EDM	1,5	-	-	106,5	64	-	111	109	2	2	-	
	120	29	2,1	2,1	141	147,6	5200	6300	NF311EDM	1,55	-	-	106,5	64	104	111	109	2	2	-	
	120	43	2,1	2,1	187	212	5000	6100	NU2311M	2,35	HJ2311E	0,19	70,5	-	64	68	111	-	2	2	9
	120	43	2,1	2,1	187	212	5000	6100	NJ2311M	2,4	HJ2311E	0,19	70,5	-	64	68	111	-	2	2	9
	120	43	2,1	2,1	187	212	5000	6100	NUP2311M	2,45	HJ2311E	0,19	70,5	-	64	68	111	-	2	2	9
	120	43	2,1	2,1	187	212	5000	6100	N2311M	2,35	-	-	106,5	64	-	111	109	2	2	-	
	120	43	2,1	2,1	187	212	5000	6100	NF2311M	0,24	-	-	106,5	64	104	111	109	2	2	-	
	120	43	2,1	2,1	199	229,7	5000	6100	NU2311E	2,2	HJ2311E	0,19	70,5	-	64	68	111	-	2	2	9
	120	43	2,1	2,1	199	229,7	5000	6100	NJ2311E	2,25	HJ2311E	0,19	70,5	-	64	68	111	-	2	2	9
	120	43	2,1	2,1	199	229,7	5000	6100	NUP2311E	2,3	HJ2311E	0,19	70,5	-	64	68	111	-	2	2	9
	120	43	2,1	2,1	199	229,7	5000	6100	N2311E	2,2	-	-	106,5	64	-	111	109	2	2	-	
	120	43	2,1	2,1	199	229,7	5000	6100	NF2311E	2,25	-	-	106,5	64	104	111	109	2	2	-	
	120	43	2,1	2,1	199	229,7	5000	6100	NU2311EDM	2,35	HJ2311E	0,19	70,5	-	64	68	111	-	2	2	9
	120	43	2,1	2,1	199	229,7	5000	6100	NJ2311EDM	2,4	HJ2311E	0,19	70,5	-	64	68	111	-	2	2	9
	120	43	2,1	2,1	199	229,7	5000	6100	NUP2311EDM	2,45	HJ2311E	0,19	70,5	-	64	68	111	-	2	2	9
120	43	2,1	2,1	199	229,7	5000	6100	N2311EDM	2,35	-	-	106,5	64	-	111	109	2	2	-		
120	43	2,1	2,1	199	229,7	5000	6100	NF2311EDM	0,24	-	-	106,5	64	104	111	109	2	2	-		
140	33	2,1	2,1	148,5	151	4500	5400	NU411M	2,5	HJ411	0,3	77,2	-	66	74	129	-	2	2	10	
140	33	2,1	2,1	148,5	151	4500	5400	NJ411M	2,55	HJ411	0,3	77,2	-	66	74	129	-	2	2	10	

SINGLE ROW CYLINDRICAL ROLLER BEARINGS ZVL SLOVAKIA, a. s.

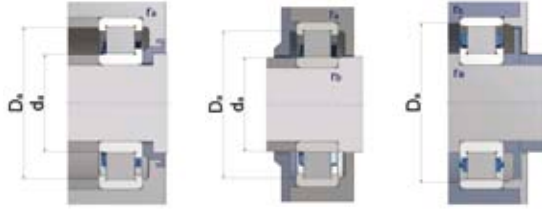

DIMENSIONS mm					BASIC LOAD RATING kN		LIMITING SPEED FOR LUBRICATION min ⁻¹		BEARING DESIGNATION	WEIGHT kg	ANGLE RING		ABUTMENT AND FILLET DIMENSIONS								
d	D	B	rs min.	r1s min.	C	Co	n	N	Fw	Ew	α	β	da min	da max	Da max	Da min	ra max	rb max	b		
																				da min	da max
55	140	33	2.1	2.1	148,5	151	4500	5400	NUP411M	2,6	HJ411	0,3	77,2	-	66	74	129	-	2	2	10
	140	33	2.1	2.1	148,5	151	4500	5400	N411M	2,5	-	-	-	117,2	66	-	129	127	2	2	-
	140	33	2.1	2.1	148,5	151	4500	5400	NF411M	2,55	-	-	-	117,2	66	115	129	127	2	2	-
60	110	22	1.5	1.5	97,5	107,3	5500	6600	NU212E	0,78	HJ212E	0,1	72	-	68	70	102	-	1,5	1,5	6
	110	22	1.5	1.5	97,5	107,3	5500	6600	NJ212E	0,8	HJ212E	0,1	72	-	68	70	102	-	1,5	1,5	6
	110	22	1.5	1.5	97,5	107,3	5500	6600	NUP212E	0,83	HJ212E	0,1	72	-	68	70	102	-	1,5	1,5	6
	110	22	1.5	1.5	97,5	107,3	5500	6600	N212E	0,78	-	-	-	100	68	-	102	102	1,5	1,5	-
	110	22	1.5	1.5	97,5	107,3	5500	6600	NF212E	0,8	-	-	-	100	68	98	102	102	1,5	1,5	-
	110	22	1.5	1.5	97,5	107,3	5500	6600	NU212EDM	0,81	HJ212E	0,1	72	-	68	70	102	-	1,5	1,5	6
	110	22	1.5	1.5	97,5	107,3	5500	6600	NJ212EDM	0,83	HJ212E	0,1	72	-	68	70	102	-	1,5	1,5	6
	110	22	1.5	1.5	97,5	107,3	5500	6600	NUP212EDM	0,86	HJ212E	0,1	72	-	68	70	102	-	1,5	1,5	6
	110	22	1.5	1.5	97,5	107,3	5500	6600	N212EDM	0,81	-	-	-	100	68	-	102	102	1,5	1,5	-
	110	22	1.5	1.5	97,5	107,3	5500	6600	NF212EDM	0,083	-	-	-	100	68	98	102	102	1,5	1,5	-
	110	28	1.5	1.5	131	156,8	5500	6600	NU2212E	1,1	HJ2212E	0,1	72	-	68	70	102	-	1,5	1,5	6
	110	28	1.5	1.5	131	156,8	5500	6600	NJ2212E	1,12	HJ2212E	0,1	72	-	68	70	102	-	1,5	1,5	6
	110	28	1.5	1.5	131	156,8	5500	6600	NUP2212E	1,15	HJ2212E	0,1	72	-	68	70	102	-	1,5	1,5	6
	110	28	1.5	1.5	131	156,8	5500	6600	N2212E	1,1	-	-	-	100	68	-	102	102	1,5	1,5	-
	110	28	1.5	1.5	131	156,8	5500	6600	NF2212E	1,12	-	-	-	100	68	98	102	102	1,5	1,5	-
	110	28	1.5	1.5	118,5	137,2	5500	6600	NU2212EM	1,15	HJ2212E	0,1	72	-	68	70	102	-	1,5	1,5	6
	110	28	1.5	1.5	118,5	137,2	5500	6600	NJ2212EM	1,17	HJ2212E	0,1	72	-	68	70	102	-	1,5	1,5	6
	110	28	1.5	1.5	118,5	137,2	5500	6600	NUP2212EM	1,2	HJ2212E	0,1	72	-	68	70	102	-	1,5	1,5	6
	110	28	1.5	1.5	118,5	137,2	5500	6600	N2212EM	1,5	-	-	-	100	68	-	102	102	1,5	1,5	-
	110	28	1.5	1.5	118,5	137,2	5500	6600	NF2212EM	1,17	-	-	-	100	68	98	102	102	1,5	1,5	-
	110	28	1.5	1.5	131	156,8	5500	6600	NU2212EDM	1,15	HJ2212E	0,1	72	-	68	70	102	-	1,5	1,5	6
	110	28	1.5	1.5	131	156,8	5500	6600	NJ2212EDM	1,17	HJ2212E	0,1	72	-	68	70	102	-	1,5	1,5	6
	110	28	1.5	1.5	131	156,8	5500	6600	NUP2212EDM	1,2	HJ2212E	0,1	72	-	68	70	102	-	1,5	1,5	6
	110	28	1.5	1.5	131	156,8	5500	6600	N2212EDM	1,5	-	-	-	100	68	-	102	102	1,5	1,5	-
	110	28	1.5	1.5	131	156,8	5500	6600	NF2212EDM	1,17	-	-	-	100	68	98	102	102	1,5	1,5	-
	130	31	2.1	2.1	155,9	165,6	4600	5200	NU312E	1,8	HJ312E	0,22	77	-	71	74	119	-	2	2	9
	130	31	2.1	2.1	155,9	165,6	4600	5200	NJ312E	1,9	HJ312E	0,22	77	-	71	74	119	-	2	2	9
	130	31	2.1	2.1	155,9	165,6	4600	5200	NUP312E	1,95	HJ312E	0,22	77	-	71	74	119	-	2	2	9
	130	31	2.1	2.1	155,9	165,6	4600	5200	N312E	1,8	-	-	-	115	71	-	119	118	2	2	-
	130	31	2.1	2.1	155,9	165,6	4600	5200	NF312E	1,9	-	-	-	115	71	112	119	118	2	2	-
	130	31	2.1	2.1	146,8	152,9	4600	5200	NU312EM	1,95	HJ312E	0,22	77	-	71	74	119	-	2	2	9
	130	31	2.1	2.1	146,8	152,9	4600	5200	NJ312EM	2,05	HJ312E	0,22	77	-	71	74	119	-	2	2	9
	130	31	2.1	2.1	146,8	152,9	4600	5200	NUP312EM	2,1	HJ312E	0,22	77	-	71	74	119	-	2	2	9
	130	31	2.1	2.1	146,8	152,9	4600	5200	N312EM	1,95	-	-	-	115	71	-	119	118	2	2	-
	130	31	2.1	2.1	146,8	152,9	4600	5200	NF312EM	2,05	-	-	-	115	71	112	119	118	2	2	-
	130	31	2.1	2.1	155,9	165,6	4600	5200	NU312EDM	1,95	HJ312E	0,22	77	-	71	74	119	-	2	2	9
	130	31	2.1	2.1	155,9	165,6	4600	5200	NJ312EDM	2,05	HJ312E	0,22	77	-	71	74	119	-	2	2	9
	130	31	2.1	2.1	155,9	165,6	4600	5200	NUP312EDM	2,1	HJ312E	0,22	77	-	71	74	119	-	2	2	9
	130	31	2.1	2.1	155,9	165,6	4600	5200	N312EDM	1,95	-	-	-	115	71	-	119	118	2	2	-
	130	31	2.1	2.1	155,9	165,6	4600	5200	NF312EDM	2,05	-	-	-	115	71	112	119	118	2	2	-
	130	46	2.1	2.1	216,7	252,8	4600	5200	NU2312E	2,75	HJ2312E	0,23	77	-	71	74	119	-	2	2	9
	130	46	2.1	2.1	216,7	252,8	4600	5200	NJ2312E	2,8	HJ2312E	0,23	77	-	71	74	119	-	2	2	9
	130	46	2.1	2.1	216,7	252,8	4600	5200	NUP2312E	2,85	HJ2312E	0,23	77	-	71	74	119	-	2	2	9
	130	46	2.1	2.1	216,7	252,8	4600	5200	N2312E	2,75	-	-	-	115	71	-	119	118	2	2	-
	130	46	2.1	2.1	216,7	252,8	4600	5200	NF2312E	2,8	-	-	-	115	71	112	119	118	2	2	-
	130	46	2.1	2.1	216,7	252,8	4600	5200	NU2312EDM	2,8	HJ2312E	0,23	77	-	71	74	119	-	2	2	9
	130	46	2.1	2.1	216,7	252,8	4600	5200	NJ2312EDM	2,85	HJ2312E	0,23	77	-	71	74	119	-	2	2	9
	130	46	2.1	2.1	216,7	252,8	4600	5200	NUP2312EDM	2,9	HJ2312E	0,23	77	-	71	74	119	-	2	2	9
130	46	2.1	2.1	216,7	252,8	4600	5200	N2312EDM	2,8	-	-	-	115	71	-	119	118	2	2	-	
130	46	2.1	2.1	216,7	252,8	4600	5200	NF2312EDM	2,85	-	-	-	115	71	112	119	118	2	2	-	
150	35	2.1	2.1	178,5	183,6	4300	5000	NU412M	3	HJ412	0,34	83	-	71	80	139	-	2	2	10	



SINGLE ROW CYLINDRICAL ROLLER BEARINGS ZVL SLOVAKIA, a. s.

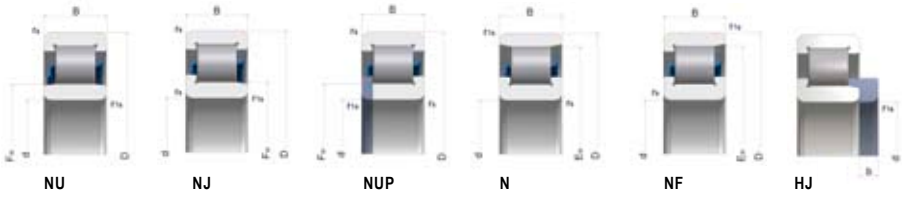

DIMENSIONS mm				BASIC LOAD RATING kN		LIMITING SPEED FOR LUBRICATION min ⁻¹		BEARING DESIGNATION	WEIGHT kg	ANGLE RING		ABUTMENT AND FILLET DIMENSIONS										
d	D	B	rs	r1s	C	Co	C	Co	Fw	Ew	da	da	Da	Da	ra	rb	b					
			min.	min.							min	max	max	min	max	max						
60	150	35	2,1	2,1	178,5	183,6	4300	5000	NJ412M	3,1	HJ412	0,34	83	-	71	80	139	-	2	2	10	
	150	35	2,1	2,1	178,5	183,6	4300	5000	NUP412M	3,15	HJ412	0,34	83	-	71	80	139	-	2	2	10	
	150	35	2,1	2,1	178,5	183,6	4300	5000	N412M	3	-	-	-	-	127	71	-	139	137	2	2	-
	150	35	2,1	2,1	178,5	183,6	4300	5000	NF412M	3,1	-	-	-	-	127	71	124	139	137	2	2	-
65	120	23	1,5	1,5	111,2	124	5200	6100	NU213E	1,05	HJ213E	0,12	78,5	-	73	76	112	-	1,5	1,5	6	
	120	23	1,5	1,5	111,2	124	5200	6100	NJ213E	1,05	HJ213E	0,12	78,5	-	73	76	112	-	1,5	1,5	6	
	120	23	1,5	1,5	111,2	124	5200	6100	NUP213E	1,1	HJ213E	0,12	78,5	-	73	76	112	-	1,5	1,5	6	
	120	23	1,5	1,5	111,2	124	5200	6100	N213E	1,05	-	-	-	108,5	73	-	112	111	1,5	1,5	-	
	120	23	1,5	1,5	111,2	124	5200	6100	NF213E	1,05	-	-	-	108,5	73	106	112	111	1,5	1,5	-	
	120	23	1,5	1,5	111,2	124	5200	6100	NU213EDM	1,15	HJ213E	0,12	78,5	-	73	76	112	-	1,5	1,5	6	
	120	23	1,5	1,5	111,2	124	5200	6100	NJ213EDM	1,15	HJ213E	0,12	78,5	-	73	76	112	-	1,5	1,5	6	
	120	23	1,5	1,5	111,2	124	5200	6100	NUP213EDM	1,2	HJ213E	0,12	78,5	-	73	76	112	-	1,5	1,5	6	
	120	23	1,5	1,5	111,2	124	5200	6100	N213EDM	1,15	-	-	-	108,5	73	-	112	111	1,5	1,5	-	
	120	23	1,5	1,5	111,2	124	5200	6100	NF213EDM	1,15	-	-	-	108,5	73	106	112	111	1,5	1,5	-	
	120	31	1,5	1,5	146,7	177,3	5200	6100	NU2213E	1,4	HJ2213E	0,12	78,5	-	73	76	112	-	1,5	1,5	6	
	120	31	1,5	1,5	146,7	177,3	5200	6100	NJ2213E	1,45	HJ2213E	0,12	78,5	-	73	76	112	-	1,5	1,5	6	
	120	31	1,5	1,5	146,7	177,3	5200	6100	NUP2213E	1,5	HJ2213E	0,12	78,5	-	73	76	112	-	1,5	1,5	6	
	120	31	1,5	1,5	146,7	177,3	5200	6100	N2213E	1,4	-	-	-	108,5	73	-	112	111	1,5	1,5	-	
	120	31	1,5	1,5	146,7	177,3	5200	6100	NF2213E	1,45	-	-	-	108,5	73	106	112	111	1,5	1,5	-	
	120	31	1,5	1,5	146,7	177,3	5200	6100	NU2213EDM	1,5	HJ2213E	0,12	78,5	-	73	76	112	-	1,5	1,5	6	
	120	31	1,5	1,5	146,7	177,3	5200	6100	NJ2213EDM	1,55	HJ2213E	0,12	78,5	-	73	76	112	-	1,5	1,5	6	
	120	31	1,5	1,5	146,7	177,3	5200	6100	NUP2213EDM	1,6	HJ2213E	0,12	78,5	-	73	76	112	-	1,5	1,5	6	
	120	31	1,5	1,5	146,7	177,3	5200	6100	N2213EDM	1,5	-	-	-	108,5	73	-	112	111	1,5	1,5	-	
	120	31	1,5	1,5	146,7	177,3	5200	6100	NF2213EDM	1,55	-	-	-	108,5	73	106	112	111	1,5	1,5	-	
	140	33	2,1	2,1	170	176,8	4200	5000	NU313M	2,4	HJ313	0,27	82,5	-	76	80	129	-	2	2	10	
	140	33	2,1	2,1	170	176,8	4200	5000	NJ313M	2,45	HJ313	0,27	82,5	-	76	80	129	-	2	2	10	
	140	33	2,1	2,1	170	176,8	4200	5000	NUP313M	2,5	HJ313	0,27	82,5	-	76	80	129	-	2	2	10	
	140	33	2,1	2,1	170	176,8	4200	5000	N313M	2,4	-	-	-	124,5	76	-	129	127	2	2	-	
	140	33	2,1	2,1	170	176,8	4200	5000	NF313M	2,45	-	-	-	124,5	76	122	129	127	2	2	-	
	140	33	2,1	2,1	180,5	191,5	4200	5000	NU313E	2,25	HJ313E	0,27	82,5	-	76	80	129	-	2	2	10	
	140	33	2,1	2,1	180,5	191,5	4200	5000	NJ313E	2,3	HJ313E	0,27	82,5	-	76	80	129	-	2	2	10	
	140	33	2,1	2,1	180,5	191,5	4200	5000	NUP313E	2,35	HJ313E	0,27	82,5	-	76	80	129	-	2	2	10	
	140	33	2,1	2,1	180,5	191,5	4200	5000	N313E	2,25	-	-	-	124,5	76	-	129	127	2	2	-	
	140	33	2,1	2,1	180,5	191,5	4200	5000	NF313E	2,3	-	-	-	124,5	76	122	129	127	2	2	-	
	140	33	2,1	2,1	180,5	191,5	4200	5000	NU313EDM	2,4	HJ313E	0,27	82,5	-	76	80	129	-	2	2	10	
	140	33	2,1	2,1	180,5	191,5	4200	5000	NJ313EDM	2,45	HJ313E	0,27	82,5	-	76	80	129	-	2	2	10	
	140	33	2,1	2,1	180,5	191,5	4200	5000	NUP313EDM	2,5	HJ313E	0,27	82,5	-	76	80	129	-	2	2	10	
	140	33	2,1	2,1	180,5	191,5	4200	5000	N313EDM	2,4	-	-	-	124,5	76	-	129	127	2	2	-	
	140	33	2,1	2,1	180,5	191,5	4200	5000	NF313EDM	2,45	-	-	-	124,5	76	122	129	127	2	2	-	
	140	48	2,1	2,1	233	265	4200	5000	NU2313M	3,35	HJ2313	0,29	82,5	-	76	80	129	-	2	2	10	
140	48	2,1	2,1	233	265	4200	5000	NJ2313M	3,4	HJ2313	0,29	82,5	-	76	80	129	-	2	2	10		
140	48	2,1	2,1	233	265	4200	5000	NUP2313M	3,5	HJ2313	0,29	82,5	-	76	80	129	-	2	2	10		
140	48	2,1	2,1	233	265	4200	5000	N2313M	3,35	-	-	-	124,5	76	-	129	127	2	2	-		
140	48	2,1	2,1	233	265	4200	5000	NF2313M	3,4	-	-	-	124,5	76	122	129	127	2	2	-		
140	48	2,1	2,1	247,5	287,2	4200	5000	NU2313E	3,3	HJ2313E	0,29	82,5	-	76	80	129	-	2	2	10		
140	48	2,1	2,1	247,5	287,2	4200	5000	NJ2313E	3,35	HJ2313E	0,29	82,5	-	76	80	129	-	2	2	10		
140	48	2,1	2,1	247,5	287,2	4200	5000	NUP2313E	3,45	HJ2313E	0,29	82,5	-	76	80	129	-	2	2	10		
140	48	2,1	2,1	247,5	287,2	4200	5000	N2313E	3,3	-	-	-	124,5	76	-	129	127	2	2	-		
140	48	2,1	2,1	247,5	287,2	4200	5000	NF2313E	3,35	-	-	-	124,5	76	122	129	127	2	2	-		
140	48	2,1	2,1	247,5	287,2	4200	5000	NJ2313EDM	3,35	HJ2313E	0,29	82,5	-	76	80	129	-	2	2	10		
140	48	2,1	2,1	247,5	287,2	4200	5000	NUP2313EDM	3,4	HJ2313E	0,29	82,5	-	76	80	129	-	2	2	10		
140	48	2,1	2,1	247,5	287,2	4200	5000	N2313EDM	3,5	HJ2313E	0,29	82,5	-	76	80	129	-	2	2	10		
140	48	2,1	2,1	247,5	287,2	4200	5000	NF2313EDM	3,35	-	-	-	124,5	76	-	129	127	2	2	-		
140	48	2,1	2,1	247,5	287,2	4200	5000	NF2313EDM	3,4	-	-	-	124,5	76	122	129	127	2	2	-		

SINGLE ROW CYLINDRICAL ROLLER BEARINGS ZVL SLOVAKIA, a. s.

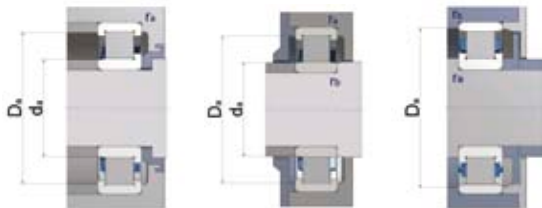

DIMENSIONS mm					BASIC LOAD RATING kN		LIMITING SPEED FOR LUBRICATION min ⁻¹		BEARING DESIGNATION	WEIGHT kg	ANGLE RING		ABUTMENT AND FILLET DIMENSIONS								
d	D	B	rs min.	r1s min.	C	Co	C	Co	C	Co	Fw	Ew	da	da	Da	Da	ra	rb	b		
													min	max	max	min	max	max			
65	160	37	2,1	2,1	201,8	212,5	4000	4700	NU413M	3,8	HJ413	0,43	89,5	-	76	86	149	-	2	2	11
	160	37	2,1	2,1	201,8	212,5	4000	4700	NJ413M	3,9	HJ413	0,43	89,5	-	76	86	149	-	2	2	11
	160	37	2,1	2,1	201,8	212,5	4000	4700	NUP413M	4,1	HJ413	0,43	89,5	-	76	86	149	-	2	2	11
	160	37	2,1	2,1	201,8	212,5	4000	4700	N413M	3,8	-	-	-	135,5	76	-	149	147	2	2	-
	160	37	2,1	2,1	201,8	212,5	4000	4700	NF413M	3,9	-	-	-	135,5	76	134	149	147	2	2	-
70	125	24	1,5	1,5	111,5	125,9	4900	6000	NU214M	1,45	HJ214	0,15	83,5	-	78	81	117	-	1,5	1,5	7
	125	24	1,5	1,5	111,5	125,9	4900	6000	NJ214M	1,45	HJ214	0,15	83,5	-	78	81	117	-	1,5	1,5	7
	125	24	1,5	1,5	111,5	125,9	4900	6000	NUP214M	1,5	HJ214	0,15	83,5	-	78	81	117	-	1,5	1,5	7
	125	24	1,5	1,5	111,5	125,9	4900	6000	N214M	1,45	-	-	-	113,5	78	-	117	116	1,5	1,5	-
	125	24	1,5	1,5	111,5	125,9	4900	6000	NF214M	1,45	-	-	-	113,5	78	111	117	116	1,5	1,5	-
	125	24	1,5	1,5	122,5	142,3	4900	6000	NU214E	1,15	HJ214E	0,15	83,5	-	78	81	117	-	1,5	1,5	7
	125	24	1,5	1,5	122,5	142,3	4900	6000	NJ214E	1,15	HJ214E	0,15	83,5	-	78	81	117	-	1,5	1,5	7
	125	24	1,5	1,5	122,5	142,3	4900	6000	NUP214E	1,2	HJ214E	0,15	83,5	-	78	81	117	-	1,5	1,5	7
	125	24	1,5	1,5	122,5	142,3	4900	6000	N214E	1,15	-	-	-	113,5	78	-	117	116	1,5	1,5	-
	125	24	1,5	1,5	122,5	142,3	4900	6000	NF214E	1,15	-	-	-	113,5	78	111	117	116	1,5	1,5	-
	125	24	1,5	1,5	122,5	142,3	4900	6000	NU214EDM	1,35	HJ214E	0,15	83,5	-	78	81	117	-	1,5	1,5	7
	125	24	1,5	1,5	122,5	142,3	4900	6000	NJ214EDM	1,35	HJ214E	0,15	83,5	-	78	81	117	-	1,5	1,5	7
	125	24	1,5	1,5	122,5	142,3	4900	6000	NUP214EDM	1,4	HJ214E	0,15	83,5	-	78	81	117	-	1,5	1,5	7
	125	24	1,5	1,5	122,5	142,3	4900	6000	N214EDM	1,35	-	-	-	113,5	78	-	117	116	1,5	1,5	-
	125	24	1,5	1,5	122,5	142,3	4900	6000	NF214EDM	1,35	-	-	-	113,5	78	111	117	116	1,5	1,5	-
	125	31	1,5	1,5	153,1	190,2	4800	5900	NU2214E	1,5	HJ2214E	0,15	83,5	-	78	81	117	-	1,5	1,5	7
	125	31	1,5	1,5	153,1	190,2	4800	5900	NJ2214E	1,55	HJ2214E	0,15	83,5	-	78	81	117	-	1,5	1,5	7
	125	31	1,5	1,5	153,1	190,2	4800	5900	NUP2214E	1,55	HJ2214E	0,15	83,5	-	78	81	117	-	1,5	1,5	7
	125	31	1,5	1,5	153,1	190,2	4800	5900	N2214E	1,5	-	-	-	113,5	78	-	117	116	1,5	1,5	-
	125	31	1,5	1,5	153,1	190,2	4800	5900	NF2214E	1,55	-	-	-	113,5	78	111	117	116	1,5	1,5	-
	125	31	1,5	1,5	153,1	190,2	4800	5900	NU2214EDM	1,5	HJ2214E	0,15	83,5	-	78	81	117	-	1,5	1,5	7
	125	31	1,5	1,5	153,1	190,2	4800	5900	NJ2214EDM	1,55	HJ2214E	0,15	83,5	-	78	81	117	-	1,5	1,5	7
	125	31	1,5	1,5	153,1	190,2	4800	5900	NUP2214EDM	1,6	HJ2214E	0,15	83,5	-	78	81	117	-	1,5	1,5	7
	125	31	1,5	1,5	153,1	190,2	4800	5900	N2214EDM	1,5	-	-	-	113,5	78	-	117	116	1,5	1,5	-
	125	31	1,5	1,5	153,1	190,2	4800	5900	NF2214EDM	1,55	-	-	-	113,5	78	111	117	116	1,5	1,5	-
	150	35	2,1	2,1	192,7	204,9	4100	4900	NU314M	3	HJ314	0,32	89	-	81	86	139	-	2	2	10
	150	35	2,1	2,1	192,7	204,9	4100	4900	NJ314M	3,05	HJ314	0,32	89	-	81	86	139	-	2	2	10
	150	35	2,1	2,1	192,7	204,9	4100	4900	NUP314M	3,1	HJ314	0,32	89	-	81	86	139	-	2	2	10
	150	35	2,1	2,1	192,7	204,9	4100	4900	N314M	3	-	-	-	133	81	-	139	136	2	2	-
	150	35	2,1	2,1	192,7	204,9	4100	4900	NF314M	3,05	-	-	-	133	81	130	139	136	2	2	-
	150	35	2,1	2,1	204,6	222	4100	4900	NU314E	2,7	HJ314E	0,32	89	-	81	86	139	-	2	2	10
	150	35	2,1	2,1	204,6	222	4100	4900	NJ314E	2,75	HJ314E	0,32	89	-	81	86	139	-	2	2	10
	150	35	2,1	2,1	204,6	222	4100	4900	NUP314E	2,8	HJ314E	0,32	89	-	81	86	139	-	2	2	10
	150	35	2,1	2,1	204,6	222	4100	4900	N314E	2,7	-	-	-	133	81	-	139	136	2	2	-
	150	35	2,1	2,1	204,6	222	4100	4900	NF314E	2,75	-	-	-	133	81	130	139	136	2	2	-
	150	35	2,1	2,1	204,6	222	4100	4900	NU314EDM	3	HJ314E	0,32	89	-	81	86	139	-	2	2	10
	150	35	2,1	2,1	204,6	222	4100	4900	NJ314EDM	3,05	HJ314E	0,32	89	-	81	86	139	-	2	2	10
	150	35	2,1	2,1	204,6	222	4100	4900	NUP314EDM	3,1	HJ314E	0,32	89	-	81	86	139	-	2	2	10
	150	35	2,1	2,1	204,6	222	4100	4900	N314EDM	3	-	-	-	133	81	-	139	136	2	2	-
	150	35	2,1	2,1	204,6	222	4100	4900	NF314EDM	3,05	-	-	-	133	81	130	139	136	2	2	-
	150	51	2,1	2,1	257,8	298	4100	4900	NU2314M	4,25	HJ2314	0,34	89	-	81	86	139	-	2	2	10
	150	51	2,1	2,1	257,8	298	4100	4900	NJ2314M	4,3	HJ2314	0,34	89	-	81	86	139	-	2	2	10
	150	51	2,1	2,1	257,8	298	4100	4900	NUP2314M	4,4	HJ2314	0,34	89	-	81	86	139	-	2	2	10
	150	51	2,1	2,1	257,8	298	4100	4900	N2314M	4,25	-	-	-	133	81	-	139	136	2	2	-
	150	51	2,1	2,1	257,8	298	4100	4900	NF2314M	4,3	-	-	-	133	81	130	139	136	2	2	-
150	51	2,1	2,1	273,8	322,9	4100	4900	NU2314E	4	HJ2314E	0,34	89	-	81	86	139	-	2	2	10	
150	51	2,1	2,1	273,8	322,9	4100	4900	NJ2314E	4,05	HJ2314E	0,34	89	-	81	86	139	-	2	2	10	
150	51	2,1	2,1	273,8	322,9	4100	4900	NUP2314E	4,15	HJ2314E	0,34	89	-	81	86	139	-	2	2	10	
150	51	2,1	2,1	273,8	322,9	4100	4900	N2314E	4	-	-	-	133	81	-	139	136	2	2	-	



SINGLE ROW CYLINDRICAL ROLLER BEARINGS ZVL SLOVAKIA, a. s.

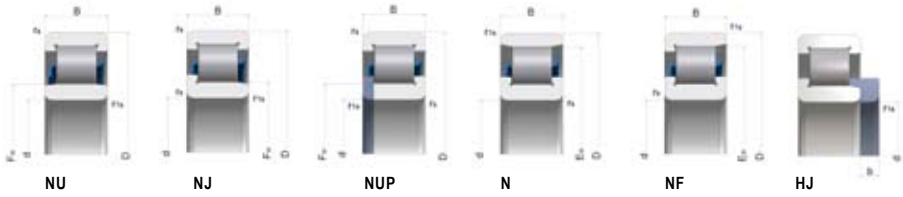

DIMENSIONS mm					BASIC LOAD RATING kN		LIMITING SPEED FOR LUBRICATION min ⁻¹		BEARING DESIGNATION	WEIGHT kg	ANGLE RING		ABUTMENT AND FILLET DIMENSIONS								
d	D	B	rs min.	r1s min.	C	Co	C ₁₀	C ₂₀	C ₃₀	C ₄₀	C ₅₀	F _w	F _e	da min	da max	Da max	Da min	ra max	ra min	rb max	b
70	150	51	2.1	2.1	273.8	322.9	4100	4900	NF2314E	4.05	-	-	-	133	81	130	139	136	2	2	-
	150	51	2.1	2.1	273.8	322.9	4100	4900	NJ2314EDM	4.25	HJ2314E	0.34	89	-	81	86	139	-	2	2	10
	150	51	2.1	2.1	273.8	322.9	4100	4900	NUP2314EDM	4.3	HJ2314E	0.34	89	-	81	86	139	-	2	2	10
	150	51	2.1	2.1	273.8	322.9	4100	4900	NUP2314EDM	4.4	HJ2314E	0.34	89	-	81	86	139	-	2	2	10
	150	51	2.1	2.1	273.8	322.9	4100	4900	N2314EDM	4.25	-	-	-	133	81	-	139	136	2	2	-
	150	51	2.1	2.1	273.8	322.9	4100	4900	NF2314EDM	4.3	-	-	-	133	81	130	139	136	2	2	-
	180	42	3	3	262.1	283.3	3400	4200	NU414M	5.5	HJ414	0.32	100	-	83	97	167	-	2.5	2.5	12
	180	42	3	3	262.1	283.3	3400	4200	NJ414M	5.6	HJ414	0.32	100	-	83	97	167	-	2.5	2.5	12
	180	42	3	3	262.1	283.3	3400	4200	NUP414M	5.8	HJ414	0.32	100	-	83	97	167	-	2.5	2.5	12
	180	42	3	3	262.1	283.3	3400	4200	N414M	5.5	-	-	-	152	83	-	167	164	2.5	2.5	-
	180	42	3	3	262.1	283.3	3400	4200	NF414M	5.6	-	-	-	152	83	149	167	164	2.5	2.5	-
	75	130	25	1.5	1.5	122.6	144.5	4500	5200	NU215M	1.45	HJ215	0.16	88.5	-	83	86	122	-	1.5	1.5
130		25	1.5	1.5	122.6	144.5	4500	5200	NJ215M	1.45	HJ215	0.16	88.5	-	83	86	122	-	1.5	1.5	7
130		25	1.5	1.5	122.6	144.5	4500	5200	N215M	1.45	-	-	-	118.5	83	-	122	121	1.5	1.5	-
130		25	1.5	1.5	122.6	144.5	4500	5200	NF215M	1.45	-	-	-	118.5	83	116	122	121	1.5	1.5	-
130		25	1.5	1.5	133.9	162.5	4500	5200	NU215E	1.25	HJ215E	0.16	88.5	-	83	86	122	-	1.5	1.5	7
130		25	1.5	1.5	133.9	162.5	4500	5200	NJ215E	1.25	HJ215E	0.16	88.5	-	83	86	122	-	1.5	1.5	7
130		25	1.5	1.5	133.9	162.5	4500	5200	NUP215E	1.3	HJ215E	0.16	88.5	-	83	86	122	-	1.5	1.5	7
130		25	1.5	1.5	133.9	162.5	4500	5200	N215E	1.25	-	-	-	118.5	83	-	122	121	1.5	1.5	-
130		25	1.5	1.5	133.9	162.5	4500	5200	NF215E	1.25	-	-	-	118.5	83	116	122	121	1.5	1.5	-
130		25	1.5	1.5	133.9	162.5	4500	5200	NU215EDM	1.45	HJ215E	0.16	88.5	-	83	86	122	-	1.5	1.5	7
130		25	1.5	1.5	133.9	162.5	4500	5200	NJ215EDM	1.45	HJ215E	0.16	88.5	-	83	86	122	-	1.5	1.5	7
130		25	1.5	1.5	133.9	162.5	4500	5200	NUP215EDM	1.5	HJ215E	0.16	88.5	-	83	86	122	-	1.5	1.5	7
130		25	1.5	1.5	133.9	162.5	4500	5200	N215EDM	1.45	-	-	-	118.5	83	-	122	121	1.5	1.5	-
130		25	1.5	1.5	133.9	162.5	4500	5200	NF215EDM	1.45	-	-	-	118.5	83	116	122	121	1.5	1.5	-
130		31	1.5	1.5	145.8	180.6	4500	5200	NU2215M	1.65	HJ2215	0.16	88.5	-	83	86	122	-	1.5	1.5	7
130		31	1.5	1.5	145.8	180.6	4500	5200	NJ2215M	1.65	HJ2215	0.16	88.5	-	83	86	122	-	1.5	1.5	7
130		31	1.5	1.5	145.8	180.6	4500	5200	NUP2215M	1.7	HJ2215	0.16	88.5	-	83	86	122	-	1.5	1.5	7
130		31	1.5	1.5	145.8	180.6	4500	5200	N2215M	1.65	-	-	-	118.5	83	-	122	121	1.5	1.5	-
130		31	1.5	1.5	145.8	180.6	4500	5200	NF2215M	1.65	-	-	-	118.5	83	116	122	121	1.5	1.5	-
130		31	1.5	1.5	159.3	203.2	4500	5200	NU2215E	1.55	HJ2215E	0.16	88.5	-	83	86	122	-	1.5	1.5	7
130		31	1.5	1.5	159.3	203.2	4500	5200	NJ2215E	1.55	HJ2215E	0.16	88.5	-	83	86	122	-	1.5	1.5	7
130		31	1.5	1.5	159.3	203.2	4500	5200	NUP2215E	1.6	HJ2215E	0.16	88.5	-	83	86	122	-	1.5	1.5	7
130		31	1.5	1.5	159.3	203.2	4500	5200	N2215E	1.55	-	-	-	118.5	83	-	122	121	1.5	1.5	-
130		31	1.5	1.5	159.3	203.2	4500	5200	NF2215E	1.55	-	-	-	118.5	83	116	122	121	1.5	1.5	-
130		31	1.5	1.5	159.3	203.2	4500	5200	NU2215EDM	1.65	HJ2215E	0.16	88.5	-	83	86	122	-	1.5	1.5	7
130		31	1.5	1.5	159.3	203.2	4500	5200	NJ2215EDM	1.65	HJ2215E	0.16	88.5	-	83	86	122	-	1.5	1.5	7
130		31	1.5	1.5	159.3	203.2	4500	5200	NUP2215EDM	1.7	HJ2215E	0.16	88.5	-	83	86	122	-	1.5	1.5	7
130		31	1.5	1.5	159.3	203.2	4500	5200	N2215EDM	1.65	-	-	-	118.5	83	-	122	121	1.5	1.5	-
130		31	1.5	1.5	159.3	203.2	4500	5200	NF2215EDM	1.65	-	-	-	118.5	83	116	122	121	1.5	1.5	-
160		37	2.1	2.1	226.2	242.8	3800	4500	NU315M	3.45	HJ315	0.39	95	-	86	92	149	-	2	2	11
160		37	2.1	2.1	226.2	242.8	3800	4500	NJ315M	3.5	HJ315	0.39	95	-	86	92	149	-	2	2	11
160		37	2.1	2.1	226.2	242.8	3800	4500	NUP315M	3.6	HJ315	0.39	95	-	86	92	149	-	2	2	11
160		37	2.1	2.1	226.2	242.8	3800	4500	N315M	3.45	-	-	-	143	86	-	149	146	2	2	-
160		37	2.1	2.1	226.2	242.8	3800	4500	NF315M	3.5	-	-	-	143	86	140	149	146	2	2	-
160		37	2.1	2.1	240.2	263	3800	4500	NJ315E	3.3	HJ315E	0.39	95	-	86	92	149	-	2	2	11
160		37	2.1	2.1	240.2	263	3800	4500	NJ315E	3.35	HJ315E	0.39	95	-	86	92	149	-	2	2	11
160		37	2.1	2.1	240.2	263	3800	4500	NUP315E	3.45	HJ315E	0.39	95	-	86	92	149	-	2	2	11
160		37	2.1	2.1	240.2	263	3800	4500	N315E	3.3	-	-	-	143	86	-	149	146	2	2	-
160		37	2.1	2.1	240.2	263	3800	4500	NF315E	3.35	-	-	-	143	86	140	149	146	2	2	-
160		37	2.1	2.1	240.2	263	3800	4500	NJ315EDM	3.55	HJ315E	0.39	95	-	86	92	149	-	2	2	11
160		37	2.1	2.1	240.2	263	3800	4500	NJ315EDM	3.6	HJ315E	0.39	95	-	86	92	149	-	2	2	11
160		37	2.1	2.1	240.2	263	3800	4500	NUP315EDM	3.7	HJ315E	0.39	95	-	86	92	149	-	2	2	11

SINGLE ROW CYLINDRICAL ROLLER BEARINGS ZVL SLOVAKIA, a. s.

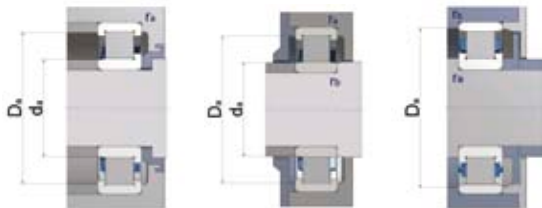

d	DIMENSIONS mm					BASIC LOAD RATING kN		LIMITING SPEED FOR LUBRICATION min ⁻¹		BEARING DESIGNATION	WEIGHT kg	ANGLE RING			ABUTMENT AND FILLET DIMENSIONS							
	D	B	rs min.	r1s min.	Co	C	3000	4500	Fw			Ew	da min	da max	Da max	Da min	ra max	rb max	b			
75	160	37	2.1	2.1	240.2	263	3800	4500	N315EDM	3,55	-	-	-	143	86	-	149	146	2	2	-	
	160	37	2.1	2.1	240.2	263	3800	4500	NF315EDM	3,6	-	-	-	143	86	140	149	146	2	2	-	
	160	55	2.1	2.1	303.3	354	3800	4500	NU2315M	5	HJ2315	0,42	95	-	86	92	149	-	2	2	11	
	160	55	2.1	2.1	303.3	354	3800	4500	NJ2315M	5,1	HJ2315	0,42	95	-	86	92	149	-	2	2	11	
	160	55	2.1	2.1	303.3	354	3800	4500	NUP2315M	5,2	HJ2315	0,42	95	-	86	92	149	-	2	2	11	
	160	55	2.1	2.1	303.3	354	3800	4500	N2315M	5	-	-	-	143	86	-	149	146	2	2	-	
	160	55	2.1	2.1	303.3	354	3800	4500	NF2315M	5,1	-	-	-	143	86	140	149	146	2	2	-	
	160	55	2.1	2.1	322.1	383.6	3800	4500	NU2315E	4,9	HJ2315E	0,42	95	-	86	92	149	-	2	2	11	
	160	55	2.1	2.1	322.1	383.6	3800	4500	NJ2315E	5	HJ2315E	0,42	95	-	86	92	149	-	2	2	11	
	160	55	2.1	2.1	322.1	383.6	3800	4500	NUP2315E	5,1	HJ2315E	0,42	95	-	86	92	149	-	2	2	11	
	160	55	2.1	2.1	322.1	383.6	3800	4500	N2315E	4,9	-	-	-	143	86	-	149	146	2	2	-	
	160	55	2.1	2.1	322.1	383.6	3800	4500	NF2315E	5	-	-	-	143	86	140	149	146	2	2	-	
	160	55	2.1	2.1	322.1	383.6	3800	4500	NU2315EDM	5	HJ2315E	0,42	95	-	86	92	149	-	2	2	11	
	160	55	2.1	2.1	322.1	383.6	3800	4500	NJ2315EDM	5,1	HJ2315E	0,42	95	-	86	92	149	-	2	2	11	
	160	55	2.1	2.1	322.1	383.6	3800	4500	NUP2315EDM	5,2	HJ2315E	0,42	95	-	86	92	149	-	2	2	11	
	160	55	2.1	2.1	322.1	383.6	3800	4500	N2315EDM	5	-	-	-	143	86	-	149	146	2	2	-	
	160	55	2.1	2.1	322.1	383.6	3800	4500	NF2315EDM	5,1	-	-	-	143	86	140	149	146	2	2	-	
	190	45	3	3	300.4	326.5	3200	3900	NU415M	6,85	HJ415	0,8	104.5	-	88	101	177	-	2.5	2.5	13	
	190	45	3	3	300.4	326.5	3200	3900	NJ415M	6,9	HJ415	0,8	104.5	-	88	101	177	-	2.5	2.5	13	
	190	45	3	3	300.4	326.5	3200	3900	NUP415M	7	HJ415	0,8	104.5	-	88	101	177	-	2.5	2.5	13	
190	45	3	3	300.4	326.5	3200	3900	N415M	6,85	-	-	-	160.5	88	-	177	174	2.5	2.5	-		
190	45	3	3	300.4	326.5	3200	3900	NF415M	6,9	-	-	-	160.5	88	157	177	174	2.5	2.5	-		
80	140	26	2.1	2.1	143.4	173.6	4400	5300	NU216E	1,5	HJ216E	0,21	95.3	-	89	93	131	-	2	2	8	
	140	26	2.1	2.1	143.4	173.6	4400	5300	NJ216E	1,55	HJ216E	0,21	95.3	-	89	93	131	-	2	2	8	
	140	26	2.1	2.1	143.4	173.6	4400	5300	NUP216E	1,6	HJ216E	0,21	95.3	-	89	93	131	-	2	2	8	
	140	26	2.1	2.1	143.4	173.6	4400	5300	N216E	1,5	-	-	-	127.3	89	-	131	130	2	2	-	
	140	26	2.1	2.1	143.4	173.6	4400	5300	NF216E	1,55	-	-	-	127.3	89	125	131	130	2	2	-	
	140	26	2.1	2.1	143.4	173.6	4400	5300	NU216EDM	1,7	HJ216E	0,21	95.3	-	89	93	131	-	2	2	8	
	140	26	2.1	2.1	143.4	173.6	4400	5300	NJ216EDM	1,75	HJ216E	0,21	95.3	-	89	93	131	-	2	2	8	
	140	26	2.1	2.1	143.4	173.6	4400	5300	NUP216EDM	1,8	HJ216E	0,21	95.3	-	89	93	131	-	2	2	8	
	140	26	2.1	2.1	143.4	173.6	4400	5300	N216EDM	1,7	-	-	-	127.3	89	-	131	130	2	2	-	
	140	26	2.1	2.1	143.4	173.6	4400	5300	NF216EDM	1,75	-	-	-	127.3	89	125	131	130	2	2	-	
	140	33	2.1	2.1	168.2	212.2	4400	5300	NU2216M	2,1	HJ2216E	0,21	95.3	-	89	93	131	-	2	2	8	
	140	33	2.1	2.1	168.2	212.2	4400	5300	NJ2216M	2,15	HJ2216E	0,21	95.3	-	89	93	131	-	2	2	8	
	140	33	2.1	2.1	168.2	212.2	4400	5300	NUP2216M	2,2	HJ2216E	0,21	95.3	-	89	93	131	-	2	2	8	
	140	33	2.1	2.1	168.2	212.2	4400	5300	N2216M	2,1	-	-	-	127.3	89	-	131	130	2	2	-	
	140	33	2.1	2.1	168.2	212.2	4400	5300	NF2216M	2,15	-	-	-	127.3	89	125	131	130	2	2	-	
	140	33	2.1	2.1	183.8	238.7	4400	5300	NU2216E	1,95	HJ2216E	0,21	95.3	-	89	93	131	-	2	2	8	
	140	33	2.1	2.1	183.8	238.7	4400	5300	NJ2216E	2	HJ2216E	0,21	95.3	-	89	93	131	-	2	2	8	
	140	33	2.1	2.1	183.8	238.7	4400	5300	NUP2216E	2,05	HJ2216E	0,21	95.3	-	89	93	131	-	2	2	8	
	140	33	2.1	2.1	183.8	238.7	4400	5300	N2216E	1,95	-	-	-	127.3	89	-	131	130	2	2	-	
	140	33	2.1	2.1	183.8	238.7	4400	5300	NF2216E	2	-	-	-	127.3	89	125	131	130	2	2	-	
140	33	2.1	2.1	183.8	238.7	4400	5300	NU2216EDM	2,1	HJ2216E	0,21	95.3	-	89	93	131	-	2	2	8		
140	33	2.1	2.1	183.8	238.7	4400	5300	NJ2216EDM	2,15	HJ2216E	0,21	95.3	-	89	93	131	-	2	2	8		
140	33	2.1	2.1	183.8	238.7	4400	5300	NUP2216EDM	2,2	HJ2216E	0,21	95.3	-	89	93	131	-	2	2	8		
140	33	2.1	2.1	183.8	238.7	4400	5300	N2216EDM	2,1	-	-	-	127.3	89	-	131	130	2	2	-		
140	33	2.1	2.1	183.8	238.7	4400	5300	NF2216EDM	2,15	-	-	-	127.3	89	125	131	130	2	2	-		
170	39	2.1	2.1	259.2	286.6	3500	4100	NU316E	3,9	HJ316E	0,44	101	-	91	98	159	-	2	2	11		
170	39	2.1	2.1	259.2	286.6	3500	4100	NJ316E	4	HJ316E	0,44	101	-	91	98	159	-	2	2	11		
170	39	2.1	2.1	259.2	286.6	3500	4100	NUP316E	4,1	HJ316E	0,44	101	-	91	98	159	-	2	2	11		
170	39	2.1	2.1	259.2	286.6	3500	4100	N316E	3,9	-	-	-	151	91	-	159	154	2	2	-		
170	39	2.1	2.1	259.2	286.6	3500	4100	NF316E	4	-	-	-	151	91	148	159	154	2	2	-		
170	39	2.1	2.1	244.1	264.5	3500	4100	NJ316EM	4,3	HJ316E	0,44	101	-	91	98	159	-	2	2	11		
170	39	2.1	2.1	244.1	264.5	3500	4100	NJ316EM	4,4	HJ316E	0,44	101	-	91	98	159	-	2	2	11		



SINGLE ROW CYLINDRICAL ROLLER BEARINGS ZVL SLOVAKIA, a. s.

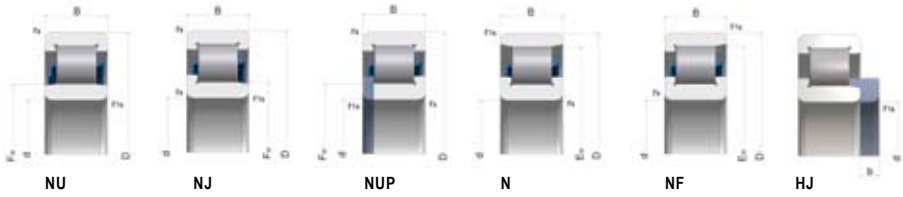

DIMENSIONS mm					BASIC LOAD RATING kN		LIMITING SPEED FOR LUBRICATION min ⁻¹		BEARING DESIGNATION	WEIGHT kg	ANGLE RING			ABUTMENT AND FILLET DIMENSIONS									
d	D	B	rs min.	r1s min.	C	Co	3500	4100	NUP316EM	4.5	HJ316E	0.44	101	Fw	Ew	da min	da max	Da max	Da min	ra max	rb max	b	
																							170
170	39	2.1	2.1	244.1	264.5	3500	4100	N316EM	4.3	-	-	-	-	151	91	-	159	154	2	2	-	-	
170	39	2.1	2.1	244.1	264.5	3500	4100	NF316EM	4.4	-	-	-	-	151	91	148	159	154	2	2	-	-	
170	39	2.1	2.1	259.2	286.6	3500	4100	NUP316EDM	4.4	HJ316E	0.44	101	-	151	91	148	159	154	2	2	11	-	
170	39	2.1	2.1	259.2	286.6	3500	4100	NJ316EDM	4.5	HJ316E	0.44	101	-	151	91	148	159	154	2	2	11	-	
170	39	2.1	2.1	259.2	286.6	3500	4100	NUP316EDM	4.6	HJ316E	0.44	101	-	151	91	148	159	154	2	2	11	-	
170	39	2.1	2.1	259.2	286.6	3500	4100	N316EDM	4.4	-	-	-	-	151	91	-	159	154	2	2	-	-	
170	39	2.1	2.1	259.2	286.6	3500	4100	NF316EDM	4.5	-	-	-	-	151	91	148	159	154	2	2	-	-	
170	58	2.1	2.1	331.1	391.5	3500	4100	NUP2316M	6.35	HJ2316	0.48	101	-	151	91	148	159	154	2	2	11	-	
170	58	2.1	2.1	331.1	391.5	3500	4100	NJ2316M	6.35	HJ2316	0.48	101	-	151	91	148	159	154	2	2	11	-	
170	58	2.1	2.1	331.1	391.5	3500	4100	NUP2316M	6.4	HJ2316	0.48	101	-	151	91	148	159	154	2	2	11	-	
170	58	2.1	2.1	331.1	391.5	3500	4100	N2316M	6.35	-	-	-	-	151	91	-	159	154	2	2	-	-	
170	58	2.1	2.1	331.1	391.5	3500	4100	NF2316M	6.35	-	-	-	-	151	91	148	159	154	2	2	-	-	
170	58	2.1	2.1	359	424.1	3500	4100	NUP2316E	5.95	HJ2316E	0.48	101	-	151	91	148	159	154	2	2	11	-	
170	58	2.1	2.1	359	424.1	3500	4100	NJ2316E	5.95	HJ2316E	0.48	101	-	151	91	148	159	154	2	2	11	-	
170	58	2.1	2.1	359	424.1	3500	4100	NUP2316E	6.1	HJ2316E	0.48	101	-	151	91	148	159	154	2	2	11	-	
170	58	2.1	2.1	359	424.1	3500	4100	N2316E	5.95	-	-	-	-	151	91	-	159	154	2	2	-	-	
170	58	2.1	2.1	359	424.1	3500	4100	NF2316E	5.95	-	-	-	-	151	91	148	159	154	2	2	-	-	
170	58	2.1	2.1	359	424.1	3500	4100	NJ2316EDM	6.35	HJ2316E	0.48	101	-	151	91	148	159	154	2	2	11	-	
170	58	2.1	2.1	359	424.1	3500	4100	NUP2316EDM	6.4	HJ2316E	0.48	101	-	151	91	148	159	154	2	2	11	-	
170	58	2.1	2.1	359	424.1	3500	4100	N2316EDM	6.35	-	-	-	-	151	91	-	159	154	2	2	-	-	
170	58	2.1	2.1	359	424.1	3500	4100	NF2316EDM	6.35	-	-	-	-	151	91	148	159	154	2	2	-	-	
200	48	3	3	323	348.5	3500	4100	NU416M	8	HJ416	0.8	110	-	170	93	-	187	184	2.5	2.5	13	-	
200	48	3	3	323	348.5	3500	4100	NJ416M	8.15	HJ416	0.8	110	-	170	93	-	187	184	2.5	2.5	13	-	
200	48	3	3	323	348.5	3500	4100	NUP416M	8.3	HJ416	0.8	110	-	170	93	-	187	184	2.5	2.5	13	-	
200	48	3	3	323	348.5	3500	4100	N416M	8	-	-	-	-	170	93	-	187	184	2.5	2.5	-	-	
200	48	3	3	323	348.5	3500	4100	NF416M	8.15	-	-	-	-	170	93	167	187	184	2.5	2.5	-	-	
150	28	2.1	2.1	171.3	205.5	4200	5000	NU217E	1.9	HJ217E	0.24	100.5	-	94	98	141	-	139	141	2	2	8	-
150	28	2.1	2.1	171.3	205.5	4200	5000	NJ217E	1.95	HJ217E	0.24	100.5	-	94	98	141	-	139	141	2	2	8	-
150	28	2.1	2.1	171.3	205.5	4200	5000	NUP217E	1.9	HJ217E	0.24	100.5	-	94	98	141	-	139	141	2	2	8	-
150	28	2.1	2.1	171.3	205.5	4200	5000	N217E	1.95	-	-	-	-	136.5	94	-	141	139	2	2	-	-	
150	28	2.1	2.1	171.3	205.5	4200	5000	NF217E	-	-	-	-	-	136.5	94	134	141	139	2	2	-	-	
150	28	2.1	2.1	164	193.5	4200	5000	NU217EM	2.1	HJ217E	0.24	100.5	-	94	98	141	-	139	141	2	2	8	-
150	28	2.1	2.1	164	193.5	4200	5000	NJ217EM	2.15	HJ217E	0.24	100.5	-	94	98	141	-	139	141	2	2	8	-
150	28	2.1	2.1	164	193.5	4200	5000	NUP217EM	2.2	HJ217E	0.24	100.5	-	94	98	141	-	139	141	2	2	8	-
150	28	2.1	2.1	164	193.5	4200	5000	N217EM	2.1	-	-	-	-	136.5	94	-	141	139	2	2	-	-	
150	28	2.1	2.1	164	193.5	4200	5000	NF217EM	2.15	-	-	-	-	136.5	94	134	141	139	2	2	-	-	
150	28	2.1	2.1	171.3	205.5	4200	5000	NU217EDM	2.1	HJ217E	0.24	100.5	-	94	98	141	-	139	141	2	2	8	-
150	28	2.1	2.1	171.3	205.5	4200	5000	NJ217EDM	2.15	HJ217E	0.24	100.5	-	94	98	141	-	139	141	2	2	8	-
150	28	2.1	2.1	171.3	205.5	4200	5000	NUP217EDM	2.2	HJ217E	0.24	100.5	-	94	98	141	-	139	141	2	2	8	-
150	28	2.1	2.1	171.3	205.5	4200	5000	N217EDM	2.1	-	-	-	-	136.5	94	-	141	139	2	2	-	-	
150	28	2.1	2.1	171.3	205.5	4200	5000	NF217EDM	2.15	-	-	-	-	136.5	94	134	141	139	2	2	-	-	
150	36	2.1	2.1	224.1	290.2	3900	4600	NU2217E	2.45	HJ2217E	0.24	100.5	-	94	98	141	-	139	141	2	2	8	-
150	36	2.1	2.1	224.1	290.2	3900	4600	NJ2217E	2.5	HJ2217E	0.24	100.5	-	94	98	141	-	139	141	2	2	8	-
150	36	2.1	2.1	224.1	290.2	3900	4600	NUP2217E	2.55	HJ2217E	0.24	100.5	-	94	98	141	-	139	141	2	2	8	-
150	36	2.1	2.1	224.1	290.2	3900	4600	N2217E	2.45	-	-	-	-	136.5	94	-	141	139	2	2	-	-	
150	36	2.1	2.1	224.1	290.2	3900	4600	NF2217E	2.5	-	-	-	-	136.5	94	134	141	139	2	2	-	-	
150	36	2.1	2.1	214.7	274.1	3900	4600	NU2217EDM	2.5	HJ2217E	0.24	100.5	-	94	98	141	-	139	141	2	2	8	-
150	36	2.1	2.1	214.7	274.1	3900	4600	NJ2217EDM	2.55	HJ2217E	0.24	100.5	-	94	98	141	-	139	141	2	2	8	-
150	36	2.1	2.1	214.7	274.1	3900	4600	NUP2217EDM	2.6	HJ2217E	0.24	100.5	-	94	98	141	-	139	141	2	2	8	-
150	36	2.1	2.1	214.7	274.1	3900	4600	N2217EDM	2.5	-	-	-	-	136.5	94	-	141	139	2	2	-	-	
150	36	2.1	2.1	214.7	274.1	3900	4600	NF2217EDM	2.55	-	-	-	-	136.5	94	134	141	139	2	2	-	-	
180	41	3	3	294.8	335.6	3200	3900	NU317E	4.7	HJ317E	0.58	108	-	98	105	167	-	175	175	2.5	2.5	12	-

SINGLE ROW CYLINDRICAL ROLLER BEARINGS ZVL SLOVAKIA, a. s.

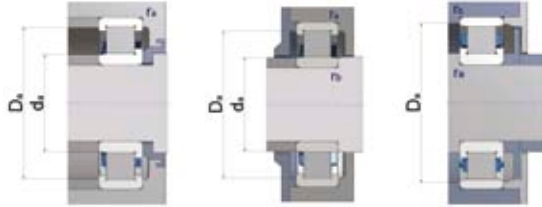

DIMENSIONS mm					BASIC LOAD RATING kN		LIMITING SPEED FOR LUBRICATION min ⁻¹		BEARING DESIGNATION	WEIGHT kg	ANGLE RING		ABUTMENT AND FILLET DIMENSIONS								
d	D	B	rs min.	r1s min.	C	Co	C	Co	C	Co	C	Co	Fw	Ew	da	da	Da	Da	ra	rb	b
															min	max	max	min	max	max	
85	180	41	3	3	294,8	335,6	3200	3900	NJ317E	4,8	HJ317E	0,58	108	-	98	105	167	-	2,5	2,5	12
	180	41	3	3	294,8	335,6	3200	3900	NUP317E	4,9	HJ317E	0,58	108	-	98	105	167	-	2,5	2,5	12
	180	41	3	3	294,8	335,6	3200	3900	N317E	4,7	-	-	-	160	98	-	167	163	2,5	2,5	-
	180	41	3	3	294,8	335,6	3200	3900	NF317E	4,8	-	-	-	160	98	157	167	163	2,5	2,5	-
	180	41	3	3	278,9	311,7	3200	3900	NJ317EM	5,1	HJ317E	0,58	108	-	98	105	167	-	2,5	2,5	12
	180	41	3	3	278,9	311,7	3200	3900	NJ317EM	5,2	HJ317E	0,58	108	-	98	105	167	-	2,5	2,5	12
	180	41	3	3	278,9	311,7	3200	3900	NUP317EM	5,3	HJ317E	0,58	108	-	98	105	167	-	2,5	2,5	12
	180	41	3	3	278,9	311,7	3200	3900	N317EM	5,1	-	-	-	160	98	-	167	163	2,5	2,5	-
	180	41	3	3	278,9	311,7	3200	3900	NF317EM	5,2	-	-	-	160	98	157	167	163	2,5	2,5	-
	180	41	3	3	366,9	443,5	3200	3900	NJ2317M	6,9	HJ2317	0,59	108	-	98	105	167	-	2,5	2,5	12
	180	41	3	3	366,9	443,5	3200	3900	NJ2317M	7,05	HJ2317	0,59	108	-	98	105	167	-	2,5	2,5	12
	180	41	3	3	366,9	443,5	3200	3900	NUP2317M	7,2	HJ2317	0,59	108	-	98	105	167	-	2,5	2,5	12
	180	41	3	3	366,9	443,5	3200	3900	N2317M	6,9	-	-	-	160	98	-	167	163	2,5	2,5	-
	180	41	3	3	366,9	443,5	3200	3900	NF2317M	7,05	-	-	-	160	98	157	167	163	2,5	2,5	-
	180	41	3	3	387,9	477,6	3200	3900	NJ2317E	6,85	HJ2317E	0,59	108	-	98	105	167	-	2,5	2,5	12
	180	41	3	3	387,9	477,6	3200	3900	NJ2317E	7	HJ2317E	0,59	108	-	98	105	167	-	2,5	2,5	12
	180	41	3	3	387,9	477,6	3200	3900	NUP2317E	7,15	HJ2317E	0,59	108	-	98	105	167	-	2,5	2,5	12
	180	41	3	3	387,9	477,6	3200	3900	N2317E	6,85	-	-	-	160	98	-	167	163	2,5	2,5	-
	180	41	3	3	387,9	477,6	3200	3900	NF2317E	7	-	-	-	160	98	157	167	163	2,5	2,5	-
	210	52	4	4	355,5	383,7	3000	3500	NJ417M	9,2	HJ417	0,8	115,5	-	101	109	194	-	3	3	14
210	52	4	4	355,5	383,7	3000	3500	NJ417M	9,4	HJ417	0,8	115,5	-	101	109	194	-	3	3	14	
210	52	4	4	355,5	383,7	3000	3500	NUP417M	9,6	HJ417	0,8	115,5	-	101	109	194	-	3	3	14	
210	52	4	4	355,5	383,7	3000	3500	N417M	9,2	-	-	-	179,5	101	-	194	191	3	3	-	
210	52	4	4	355,5	383,7	3000	3500	NF417M	9,4	-	-	-	179,5	101	176	194	191	3	3	-	
90	160	30	2,1	2,1	181,2	215,8	3900	4600	NJ218M	2,6	HJ218	0,31	107	-	99	104	151	-	2	2	9
	160	30	2,1	2,1	181,2	215,8	3900	4600	NJ218M	2,65	HJ218	0,31	107	-	99	104	151	-	2	2	9
	160	30	2,1	2,1	181,2	215,8	3900	4600	NUP218M	2,7	HJ218	0,31	107	-	99	104	151	-	2	2	9
	160	30	2,1	2,1	181,2	215,8	3900	4600	N218M	2,6	-	-	-	145	99	-	151	148	2	2	-
	160	30	2,1	2,1	181,2	215,8	3900	4600	NF218M	2,65	-	-	-	145	99	142	151	148	2	2	-
	160	30	2,1	2,1	189,6	229,3	3900	4600	NJ218E	2,35	HJ218E	0,31	107	-	99	104	151	-	2	2	9
	160	30	2,1	2,1	189,6	229,3	3900	4600	NJ218E	2,4	HJ218E	0,31	107	-	99	104	151	-	2	2	9
	160	30	2,1	2,1	189,6	229,3	3900	4600	NUP218E	2,45	HJ218E	0,31	107	-	99	104	151	-	2	2	9
	160	30	2,1	2,1	189,6	229,3	3900	4600	N218E	2,35	-	-	-	145	99	-	151	148	2	2	-
	160	30	2,1	2,1	189,6	229,3	3900	4600	NF218E	2,4	-	-	-	145	99	142	151	148	2	2	-
	160	30	2,1	2,1	189,6	229,3	3900	4600	NJ218EDM	2,6	HJ218E	0,31	107	-	99	104	151	-	2	2	9
	160	30	2,1	2,1	189,6	229,3	3900	4600	NJ218EDM	2,65	HJ218E	0,31	107	-	99	104	151	-	2	2	9
	160	30	2,1	2,1	189,6	229,3	3900	4600	NUP218EDM	2,7	HJ218E	0,31	107	-	99	104	151	-	2	2	9
	160	30	2,1	2,1	189,6	229,3	3900	4600	N218EDM	2,6	-	-	-	145	99	-	151	148	2	2	-
	160	30	2,1	2,1	189,6	229,3	3900	4600	NF218EDM	2,65	-	-	-	145	99	142	151	148	2	2	-
	160	40	2,1	2,1	231,3	295,3	3800	4400	NJ2218M	3,3	HJ2218	0,31	107	-	99	104	151	-	2	2	9
	160	40	2,1	2,1	231,3	295,3	3800	4400	NJ2218M	3,4	HJ2218	0,31	107	-	99	104	151	-	2	2	9
	160	40	2,1	2,1	231,3	295,3	3800	4400	NUP2218M	3,5	HJ2218	0,31	107	-	99	104	151	-	2	2	9
	160	40	2,1	2,1	231,3	295,3	3800	4400	N2218M	3,3	-	-	-	145	99	-	151	148	2	2	-
	160	40	2,1	2,1	231,3	295,3	3800	4400	NF2218M	3,4	-	-	-	145	99	142	151	148	2	2	-
	160	40	2,1	2,1	242	313,8	3800	4400	NJ2218E	3,1	HJ2218E	0,31	107	-	99	104	151	-	2	2	9
	160	40	2,1	2,1	242	313,8	3800	4400	NJ2218E	3,2	HJ2218E	0,31	107	-	99	104	151	-	2	2	9
	160	40	2,1	2,1	242	313,8	3800	4400	NUP2218E	3,3	HJ2218E	0,31	107	-	99	104	151	-	2	2	9
	160	40	2,1	2,1	242	313,8	3800	4400	N2218E	3,1	-	-	-	145	99	-	151	148	2	2	-
160	40	2,1	2,1	242	313,8	3800	4400	NF2218E	3,2	-	-	-	145	99	142	151	148	2	2	-	
160	40	2,1	2,1	242	313,8	3800	4400	NJ2218EDM	3,3	HJ2218E	0,31	107	-	99	104	151	-	2	2	9	
160	40	2,1	2,1	242	313,8	3800	4400	NJ2218EDM	3,4	HJ2218E	0,31	107	-	99	104	151	-	2	2	9	
160	40	2,1	2,1	242	313,8	3800	4400	NUP2218EDM	3,5	HJ2218E	0,31	107	-	99	104	151	-	2	2	9	
160	40	2,1	2,1	242	313,8	3800	4400	N2218EDM	3,3	-	-	-	145	99	-	151	148	2	2	-	
160	40	2,1	2,1	242	313,8	3800	4400	NF2218EDM	3,4	-	-	-	145	99	142	151	148	2	2	-	



SINGLE ROW CYLINDRICAL ROLLER BEARINGS ZVL SLOVAKIA, a. s.

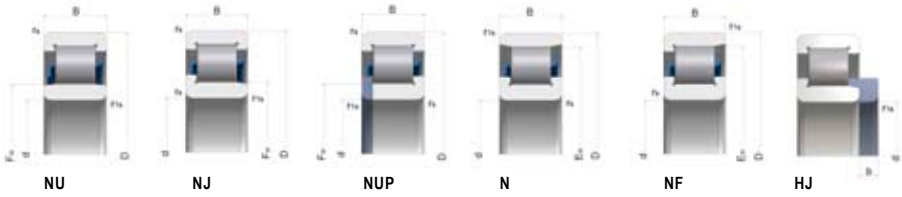

DIMENSIONS mm				BASIC LOAD RATING kN		LIMITING SPEED FOR LUBRICATION min ⁻¹		BEARING DESIGNATION	WEIGHT kg	ANGLE RING			ABUTMENT AND FILLET DIMENSIONS								
d	D	B	rs min.	r1s min.	C	Co	n	N	W	α	β	Fw	Ew	da	da	Da	Da	ra	rb	b	
														min	max	max	min	max	max		
90	190	43	3	3	319,7	359,7	3000	3600	NU318E	5,45	HJ318E	0,6	113,5	-	103	110	177	-	2,5	2,5	12
	190	43	3	3	319,7	359,7	3000	3600	NJ318E	5,55	HJ318E	0,6	113,5	-	103	110	177	-	2,5	2,5	12
	190	43	3	3	319,7	359,7	3000	3600	NUP318E	5,65	HJ318E	0,6	113,5	-	103	110	177	-	2,5	2,5	12
	190	43	3	3	319,7	359,7	3000	3600	N318E	5,45	-	-	-	169,5	103	-	177	173	2,5	2,5	-
	190	43	3	3	319,7	359,7	3000	3600	NF318E	5,55	-	-	-	169,5	103	166	177	173	2,5	2,5	-
	190	43	3	3	319,7	359,7	3000	3600	NU318EM	5,7	HJ318E	0,6	113,5	-	103	110	177	-	2,5	2,5	12
	190	43	3	3	319,7	359,7	3000	3600	NJ318EM	5,8	HJ318E	0,6	113,5	-	103	110	177	-	2,5	2,5	12
	190	43	3	3	319,7	359,7	3000	3600	NUP318EM	5,9	HJ318E	0,6	113,5	-	103	110	177	-	2,5	2,5	12
	190	43	3	3	319,7	359,7	3000	3600	N318EM	5,7	-	-	-	169,5	103	-	177	173	2,5	2,5	-
	190	43	3	3	319,7	359,7	3000	3600	NF318EM	5,8	-	-	-	169,5	103	166	177	173	2,5	2,5	-
	190	64	3	3	422	513,9	2900	3500	NU2318E	8	HJ2318E	0,65	113,5	-	103	110	177	-	2,5	2,5	12
	190	64	3	3	422	513,9	2900	3500	NJ2318E	8,15	HJ2318E	0,65	113,5	-	103	110	177	-	2,5	2,5	12
	190	64	3	3	422	513,9	2900	3500	NUP2318E	8,3	HJ2318E	0,65	113,5	-	103	110	177	-	2,5	2,5	12
	190	64	3	3	422	513,9	2900	3500	N2318E	8	-	-	-	169,5	103	-	177	173	2,5	2,5	-
	190	64	3	3	422	513,9	2900	3500	NF2318E	8,15	-	-	-	169,5	103	166	177	173	2,5	2,5	-
	190	64	3	3	422	513,9	2900	3500	NU2318EM	8,8	HJ2318E	0,65	113,5	-	103	110	177	-	2,5	2,5	12
	190	64	3	3	422	513,9	2900	3500	NJ2318EM	8,95	HJ2318E	0,65	113,5	-	103	110	177	-	2,5	2,5	12
	190	64	3	3	422	513,9	2900	3500	NUP2318EM	9,1	HJ2318E	0,65	113,5	-	103	110	177	-	2,5	2,5	12
	190	64	3	3	422	513,9	2900	3500	N2318EM	8,8	-	-	-	169,5	103	-	177	173	2,5	2,5	-
	190	64	3	3	422	513,9	2900	3500	NF2318EM	8,95	-	-	-	169,5	103	166	177	173	2,5	2,5	-
	225	54	4	4	399,7	436,4	2700	3200	NU418M	11,3	HJ418	1,05	123,5	-	106	120	209	-	3	3	14
	225	54	4	4	399,7	436,4	2700	3200	NJ418M	11,3	HJ418	1,05	123,5	-	106	120	209	-	3	3	14
	225	54	4	4	399,7	436,4	2700	3200	N418M	11,3	-	-	-	191,5	106	-	209	206	3	3	-
	225	54	4	4	399,7	436,4	2700	3200	NF418M	11,3	-	-	-	191,5	106	188	209	206	3	3	-
95	170	32	2,1	2,1	220,2	264,7	3600	4400	NU219E	2,85	HJ219E	0,33	112,5	-	106	110	159	-	2	2	9
	170	32	2,1	2,1	220,2	264,7	3600	4400	NJ219E	2,9	HJ219E	0,33	112,5	-	106	110	159	-	2	2	9
	170	32	2,1	2,1	220,2	264,7	3600	4400	NUP219E	3	HJ219E	0,33	112,5	-	106	110	159	-	2	2	9
	170	32	2,1	2,1	220,2	264,7	3600	4400	N219E	2,85	-	-	-	154,5	106	-	159	157	2	2	-
	170	32	2,1	2,1	220,2	264,7	3600	4400	NF219E	2,9	-	-	-	154,5	106	152	159	157	2	2	-
	170	32	2,1	2,1	210,4	249,2	3600	4400	NU219EM	3	HJ219E	0,33	112,5	-	106	110	159	-	2	2	9
	170	32	2,1	2,1	210,4	249,2	3600	4400	NJ219EM	3,05	HJ219E	0,33	112,5	-	106	110	159	-	2	2	9
	170	32	2,1	2,1	210,4	249,2	3600	4400	NUP219EM	3,15	HJ219E	0,33	112,5	-	106	110	159	-	2	2	9
	170	32	2,1	2,1	210,4	249,2	3600	4400	N219EM	3	-	-	-	154,5	106	-	159	157	2	2	-
	170	32	2,1	2,1	210,4	249,2	3600	4400	NF219EM	3,05	-	-	-	154,5	106	152	159	157	2	2	-
	170	43	2,1	2,1	286,1	370,6	3600	4400	NU2219E	3,85	HJ2219E	0,35	112,5	-	106	110	159	-	2	2	9
	170	43	2,1	2,1	286,1	370,6	3600	4400	NJ2219E	3,95	HJ2219E	0,35	112,5	-	106	110	159	-	2	2	9
	170	43	2,1	2,1	286,1	370,6	3600	4400	NUP2219E	4	HJ2219E	0,35	112,5	-	106	110	159	-	2	2	9
	170	43	2,1	2,1	286,1	370,6	3600	4400	N2219E	3,85	-	-	-	154,5	106	-	159	157	2	2	-
	170	43	2,1	2,1	286,1	370,6	3600	4400	NF2219E	3,95	-	-	-	154,5	106	152	159	157	2	2	-
	170	43	2,1	2,1	273,3	348,8	3600	4400	NU2219EM	3,95	HJ2219E	0,35	112,5	-	106	110	159	-	2	2	9
	170	43	2,1	2,1	273,3	348,8	3600	4400	NJ2219EM	4,05	HJ2219E	0,35	112,5	-	106	110	159	-	2	2	9
	170	43	2,1	2,1	273,3	348,8	3600	4400	NUP2219EM	4,1	HJ2219E	0,35	112,5	-	106	110	159	-	2	2	9
	170	43	2,1	2,1	273,3	348,8	3600	4400	N2219EM	3,95	-	-	-	154,5	106	-	159	157	2	2	-
	170	43	2,1	2,1	273,3	348,8	3600	4400	NF2219EM	4,05	-	-	-	154,5	106	152	159	157	2	2	-
	200	45	3	3	338,3	392,5	3000	3700	NU319E	6,25	HJ319E	0,76	121,5	-	108	118	187	-	2,5	2,5	13
	200	45	3	3	338,3	392,5	3000	3700	NJ319E	6,4	HJ319E	0,76	121,5	-	108	118	187	-	2,5	2,5	13
	200	45	3	3	338,3	392,5	3000	3700	NUP319E	6,5	HJ319E	0,76	121,5	-	108	118	187	-	2,5	2,5	13
	200	45	3	3	338,3	392,5	3000	3700	N319E	6,25	-	-	-	177,5	108	-	187	181	2,5	2,5	-
200	45	3	3	338,3	392,5	3000	3700	NF319E	6,4	-	-	-	177,5	108	174	187	181	2,5	2,5	-	
200	45	3	3	320	364,5	3000	3700	NU319EM	6,5	HJ319E	0,76	121,5	-	108	118	187	-	2,5	2,5	13	
200	45	3	3	320	364,5	3000	3700	NJ319EM	6,65	HJ319E	0,76	121,5	-	108	118	187	-	2,5	2,5	13	
200	45	3	3	320	364,5	3000	3700	NUP319EM	6,75	HJ319E	0,76	121,5	-	108	118	187	-	2,5	2,5	13	
200	45	3	3	320	364,5	3000	3700	N319EM	6,5	-	-	-	177,5	108	-	187	181	2,5	2,5	-	

SINGLE ROW CYLINDRICAL ROLLER BEARINGS ZVL SLOVAKIA, a. s.

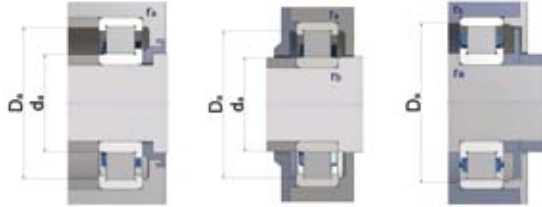

DIMENSIONS mm					BASIC LOAD RATING kN		LIMITING SPEED FOR LUBRICATION min ⁻¹		BEARING DESIGNATION	WEIGHT kg	ANGLE RING				ABUTMENT AND FILLET DIMENSIONS						
d	D	B	rs min.	r1s min.	C		Co		Fw	Ew	da min	da max	Da max	Da min	ra max	rb max	b				
					C	Co	C	Co													
95	200	45	3	3	320	364,5	3000	3700	NF319EM	6,65	-	-	-	177,5	108	174	187	181	2,5	2,5	-
	200	67	3	3	422,3	520,7	2800	3500	NU2319M	9,4	HJ2319	0,81	121,5	-	108	118	187	-	2,5	2,5	13
	200	67	3	3	422,3	520,7	2800	3500	NJ2319M	9,6	HJ2319	0,81	121,5	-	108	118	187	-	2,5	2,5	13
	200	67	3	3	422,3	520,7	2800	3500	NUP2319M	9,8	HJ2319	0,81	121,5	-	108	118	187	-	2,5	2,5	13
	200	67	3	3	422,3	520,7	2800	3500	N2319M	9,4	-	-	-	177,5	108	-	187	181	2,5	2,5	-
	200	67	3	3	422,3	520,7	2800	3500	NF2319M	9,6	-	-	-	177,5	108	174	187	181	2,5	2,5	-
	200	67	3	3	446,5	560,7	2800	3500	NU2319E	9,35	HJ2319E	0,81	121,5	-	108	118	187	-	2,5	2,5	13
	200	67	3	3	446,5	560,7	2800	3500	NJ2319E	9,55	HJ2319E	0,81	121,5	-	108	118	187	-	2,5	2,5	13
	200	67	3	3	446,5	560,7	2800	3500	NUP2319E	9,75	HJ2319E	0,81	121,5	-	108	118	187	-	2,5	2,5	13
	200	67	3	3	446,5	560,7	2800	3500	N2319E	9,35	-	-	-	177,5	108	-	187	181	2,5	2,5	-
	200	67	3	3	446,5	560,7	2800	3500	NF2319E	9,55	-	-	-	177,5	108	174	187	181	2,5	2,5	-
	240	55	4	4	401,1	443,6	2500	3000	NU419M	13,1	HJ419	1,35	133,5	-	111	130	224	-	3	3	15
	240	55	4	4	401,1	443,6	2500	3000	NJ419M	13,3	HJ419	1,35	133,5	-	111	130	224	-	3	3	15
	240	55	4	4	401,1	443,6	2500	3000	NUP419M	13,6	HJ419	1,35	133,5	-	111	130	224	-	3	3	15
	240	55	4	4	401,1	443,6	2500	3000	N419M	13,1	-	-	-	201,5	111	-	224	221	3	3	-
	240	55	4	4	401,1	443,6	2500	3000	NF419M	13,3	-	-	-	201,5	111	198	224	221	3	3	-
100	180	34	2,1	2,1	249,2	305,5	3400	4100	NU220E	3,45	HJ220E	0,42	119	-	111	116	169	-	2	2	10
	180	34	2,1	2,1	249,2	305,5	3400	4100	NJ220E	3,5	HJ220E	0,42	119	-	111	116	169	-	2	2	10
	180	34	2,1	2,1	249,2	305,5	3400	4100	NUP220E	3,6	HJ220E	0,42	119	-	111	116	169	-	2	2	10
	180	34	2,1	2,1	249,2	305,5	3400	4100	N220E	3,45	-	-	-	163	111	-	169	166	2	2	-
	180	34	2,1	2,1	249,2	305,5	3400	4100	NF220E	3,5	-	-	-	163	111	160	169	166	2	2	-
	180	34	2,1	2,1	238,1	287,6	3400	4100	NU220EM	3,75	HJ220E	0,42	119	-	111	116	169	-	2	2	10
	180	34	2,1	2,1	238,1	287,6	3400	4100	NJ220EM	3,8	HJ220E	0,42	119	-	111	116	169	-	2	2	10
	180	34	2,1	2,1	238,1	287,6	3400	4100	NUP220EM	3,9	HJ220E	0,42	119	-	111	116	169	-	2	2	10
	180	34	2,1	2,1	238,1	287,6	3400	4100	N220EM	3,75	-	-	-	163	111	-	169	166	2	2	-
	180	34	2,1	2,1	238,1	287,6	3400	4100	NF220EM	3,8	-	-	-	163	111	160	169	166	2	2	-
	180	34	2,1	2,1	249,2	305,5	3400	4100	NU220EDM	3,75	HJ220E	0,42	119	-	111	116	169	-	2	2	10
	180	34	2,1	2,1	249,2	305,5	3400	4100	NJ220EDM	3,8	HJ220E	0,42	119	-	111	116	169	-	2	2	10
	180	34	2,1	2,1	249,2	305,5	3400	4100	NUP220EDM	3,9	HJ220E	0,42	119	-	111	116	169	-	2	2	10
	180	34	2,1	2,1	249,2	305,5	3400	4100	N220EDM	3,75	-	-	-	163	111	-	169	166	2	2	-
	180	34	2,1	2,1	249,2	305,5	3400	4100	NF220EDM	3,8	-	-	-	163	111	160	169	166	2	2	-
	180	46	2,1	2,1	333,5	444,4	3400	4100	NU2220E	4,7	HJ2220E	0,43	119	-	111	116	169	-	2	2	10
	180	46	2,1	2,1	333,5	444,4	3400	4100	NJ2220E	4,8	HJ2220E	0,43	119	-	111	116	169	-	2	2	10
	180	46	2,1	2,1	333,5	444,4	3400	4100	NUP2220E	4,9	HJ2220E	0,43	119	-	111	116	169	-	2	2	10
	180	46	2,1	2,1	333,5	444,4	3400	4100	N2220E	4,7	-	-	-	163	111	-	169	166	2	2	-
	180	46	2,1	2,1	333,5	444,4	3400	4100	NF2220E	4,8	-	-	-	163	111	160	169	166	2	2	-
	180	46	2,1	2,1	333,5	444,4	3400	4100	NU2220EDM	4,7	HJ2220E	0,43	119	-	111	116	169	-	2	2	10
	180	46	2,1	2,1	333,5	444,4	3400	4100	NJ2220EDM	4,8	HJ2220E	0,43	119	-	111	116	169	-	2	2	10
	180	46	2,1	2,1	333,5	444,4	3400	4100	NUP2220EDM	4,9	HJ2220E	0,43	119	-	111	116	169	-	2	2	10
	180	46	2,1	2,1	333,5	444,4	3400	4100	N2220EDM	4,7	-	-	-	163	111	-	169	166	2	2	-
	180	46	2,1	2,1	333,5	444,4	3400	4100	NF2220EDM	4,7	-	-	-	163	111	160	169	166	2	2	-
	215	47	3	3	379,1	424,3	2600	3200	NU320E	7,6	HJ320E	0,87	127,5	-	113	124	202	-	2,5	2,5	13
	215	47	3	3	379,1	424,3	2600	3200	NJ320E	7,8	HJ320E	0,87	127,5	-	113	124	202	-	2,5	2,5	13
	215	47	3	3	379,1	424,3	2600	3200	NUP320E	7,95	HJ320E	0,87	127,5	-	113	124	202	-	2,5	2,5	13
	215	47	3	3	379,1	424,3	2600	3200	N320E	7,6	-	-	-	191,5	113	-	202	195	2,5	2,5	-
	215	47	3	3	379,1	424,3	2600	3200	NF320E	7,8	-	-	-	191,5	113	188	202	195	2,5	2,5	-
	215	47	3	3	379,1	424,3	2600	3200	NU320EM	8,45	HJ320E	0,87	127,5	-	113	124	202	-	2,5	2,5	13
	215	47	3	3	379,1	424,3	2600	3200	NJ320EM	8,65	HJ320E	0,87	127,5	-	113	124	202	-	2,5	2,5	13
215	47	3	3	379,1	424,3	2600	3200	NUP320EM	8,7	HJ320E	0,87	127,5	-	113	124	202	-	2,5	2,5	13	
215	47	3	3	379,1	424,3	2600	3200	N320EM	8,45	-	-	-	191,5	113	-	202	195	2,5	2,5	-	
215	47	3	3	379,1	424,3	2600	3200	NF320EM	8,65	-	-	-	191,5	113	188	202	195	2,5	2,5	-	
215	73	3	3	561	702,3	2600	3200	NU2320E	12	HJ2320E	0,93	127,5	-	113	124	202	-	2,5	2,5	13	
215	73	3	3	561	702,3	2600	3200	NJ2320E	12	HJ2320E	0,93	127,5	-	113	124	202	-	2,5	2,5	13	
215	73	3	3	561	702,3	2600	3200	NUP2320E	12,5	HJ2320E	0,93	127,5	-	113	124	202	-	2,5	2,5	13	



SINGLE ROW CYLINDRICAL ROLLER BEARINGS ZVL SLOVAKIA, a. s.

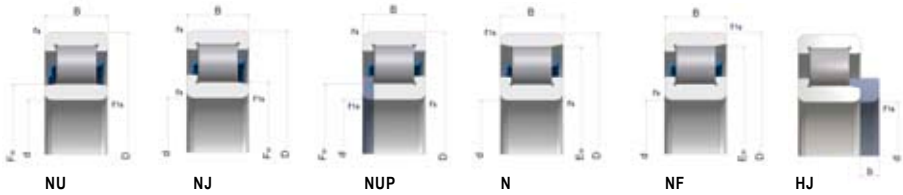

DIMENSIONS mm				BASIC LOAD RATING kN		LIMITING SPEED FOR LUBRICATION min ⁻¹		BEARING DESIGNATION	WEIGHT kg	ANGLE RING		ABUTMENT AND FILLET DIMENSIONS									
d	D	B	rs min.	r1s min.	C	Co	C ₁₀	C ₂₀	F _w	F _e	da	da	Da	Da	ra	rb	b				
																		min	max	min	max
100	215	73	3	3	561	702,3	2600	3200	N2320E	12	-	-	-	191,5	113	-	202	195	2,5	2,5	-
	215	73	3	3	561	702,3	2600	3200	NF2320E	12	-	-	-	191,5	113	188	202	195	2,5	2,5	-
	215	73	3	3	561	702,3	2600	3200	NU2320EM	12	HJ2320E	0,93	127,5	-	113	124	202	-	2,5	2,5	13
	215	73	3	3	561	702,3	2600	3200	NJ2320EM	12	HJ2320E	0,93	127,5	-	113	124	202	-	2,5	2,5	13
	215	73	3	3	561	702,3	2600	3200	NUP2320EM	12,5	HJ2320E	0,93	127,5	-	113	124	202	-	2,5	2,5	13
	215	73	3	3	561	702,3	2600	3200	N2320EM	12	-	-	-	191,5	113	-	202	195	2,5	2,5	-
	215	73	3	3	561	702,3	2600	3200	NF2320EM	12	-	-	-	191,5	113	188	202	195	2,5	2,5	-
	250	58	4	4	447,5	498,2	2200	2700	HJ420	14,3	HJ420	1,55	139	-	116	135	234	-	3	3	16
	250	58	4	4	447,5	498,2	2200	2700	NJ420M	14,3	HJ420	1,55	139	-	116	135	234	-	3	3	16
	250	58	4	4	447,5	498,2	2200	2700	NUP420M	14,5	HJ420	1,55	139	-	116	135	234	-	3	3	16
	250	58	4	4	447,5	498,2	2200	2700	N420M	14,3	-	-	-	211	116	-	234	231	3	3	-
	250	58	4	4	447,5	498,2	2200	2700	NF420M	14,3	-	-	-	211	116	208	234	231	3	3	-
105	225	49	3	3	425,9	480,2	2100	2800	NU321EM	8,8	HJ321E	1	133	-	118	130	212	-	2,5	2,5	13
	225	49	3	3	425,9	480,2	2100	2800	NJ321EM	8,9	HJ321E	1	133	-	118	130	212	-	2,5	2,5	13
	225	49	3	3	425,9	480,2	2100	2800	NUP321EM	9,3	HJ321E	1	133	-	118	130	212	-	2,5	2,5	13
	225	49	3	3	425,9	480,2	2100	2800	N321EM	8,8	-	-	-	201	118	-	212	203	2,5	2,5	-
	225	49	3	3	425,9	480,2	2100	2800	NF321EM	8,9	-	-	-	201	118	198	212	203	2,5	2,5	-
110	200	38	2,1	2,1	292,5	364,8	3000	3600	NU222E	4,8	HJ222E	0,6	132,5	-	121	130	189	-	2	2	11
	200	38	2,1	2,1	292,5	364,8	3000	3600	NJ222E	4,9	HJ222E	0,6	132,5	-	121	130	189	-	2	2	11
	200	38	2,1	2,1	292,5	364,8	3000	3600	NUP222E	5	HJ222E	0,6	132,5	-	121	130	189	-	2	2	11
	200	38	2,1	2,1	292,5	364,8	3000	3600	N222E	4,8	-	-	-	180,5	121	-	189	183	2	2	-
	200	38	2,1	2,1	292,5	364,8	3000	3600	NF222E	4,9	-	-	-	180,5	121	177	189	183	2	2	-
	200	38	2,1	2,1	279,5	343,3	3000	3600	NU222EM	5,3	HJ222E	0,6	132,5	-	121	130	189	-	2	2	11
	200	38	2,1	2,1	279,5	343,3	3000	3600	NJ222EM	5,4	HJ222E	0,6	132,5	-	121	130	189	-	2	2	11
	200	38	2,1	2,1	279,5	343,3	3000	3600	NUP222EM	5,5	HJ222E	0,6	132,5	-	121	130	189	-	2	2	11
	200	38	2,1	2,1	279,5	343,3	3000	3600	N222EM	5,3	-	-	-	180,5	121	-	189	183	2	2	-
	200	38	2,1	2,1	279,5	343,3	3000	3600	NF222EM	5,4	-	-	-	180,5	121	177	189	183	2	2	-
	200	38	2,1	2,1	292,5	364,8	3000	3600	NU222EDM	5,3	HJ222E	0,6	132,5	-	121	130	189	-	2	2	11
	200	38	2,1	2,1	292,5	364,8	3000	3600	NJ222EDM	5,4	HJ222E	0,6	132,5	-	121	130	189	-	2	2	11
	200	38	2,1	2,1	292,5	364,8	3000	3600	NUP222EDM	5,5	HJ222E	0,6	132,5	-	121	130	189	-	2	2	11
	200	38	2,1	2,1	292,5	364,8	3000	3600	N222EDM	5,3	-	-	-	180,5	121	-	189	183	2	2	-
	200	38	2,1	2,1	292,5	364,8	3000	3600	NF222EDM	5,4	-	-	-	180,5	121	177	189	183	2	2	-
	200	53	2,1	2,1	358	472	3000	3600	NU222EM	6,7	HJ222E	0,63	132,5	-	121	130	189	-	2	2	11
	200	53	2,1	2,1	358	472	3000	3600	NJ222EM	6,85	HJ222E	0,63	132,5	-	121	130	189	-	2	2	11
	200	53	2,1	2,1	358	472	3000	3600	NUP222EM	7	HJ222E	0,63	132,5	-	121	130	189	-	2	2	11
	200	53	2,1	2,1	358	472	3000	3600	N222EM	6,7	-	-	-	180,5	121	-	189	183	2	2	-
	200	53	2,1	2,1	358	472	3000	3600	NF222EM	6,85	-	-	-	180,5	121	177	189	183	2	2	-
	200	53	2,1	2,1	374,7	501,6	3000	3600	NU222EDM	6,7	HJ222E	0,63	132,5	-	121	130	189	-	2	2	11
	200	53	2,1	2,1	374,7	501,6	3000	3600	NJ222EDM	6,85	HJ222E	0,63	132,5	-	121	130	189	-	2	2	11
	200	53	2,1	2,1	374,7	501,6	3000	3600	NUP222EDM	7	HJ222E	0,63	132,5	-	121	130	189	-	2	2	11
	200	53	2,1	2,1	374,7	501,6	3000	3600	N222EDM	6,7	-	-	-	180,5	121	-	189	183	2	2	-
	200	53	2,1	2,1	374,7	501,6	3000	3600	NF222EDM	6,85	-	-	-	180,5	121	177	189	183	2	2	-
	240	50	3	3	451	524,5	2400	2800	NU322E	10,5	HJ322E	1,2	143	-	123	139	227	-	2,5	2,5	14
	240	50	3	3	451	524,5	2400	2800	NJ322E	10,5	HJ322E	1,2	143	-	123	139	227	-	2,5	2,5	14
	240	50	3	3	451	524,5	2400	2800	NUP322E	11	HJ322E	1,2	143	-	123	139	227	-	2,5	2,5	14
	240	50	3	3	451	524,5	2400	2800	N322E	10,5	-	-	-	211	123	-	227	215	2,5	2,5	-
	240	50	3	3	451	524,5	2400	2800	NF322E	10,5	-	-	-	211	123	208	227	215	2,5	2,5	-
	240	50	3	3	451	524,5	2400	2800	NU322EM	11,3	HJ322E	1,2	143	-	123	139	227	-	2,5	2,5	14
	240	50	3	3	451	524,5	2400	2800	NJ322EM	11,3	HJ322E	1,2	143	-	123	139	227	-	2,5	2,5	14
240	50	3	3	451	524,5	2400	2800	NUP322EM	11,8	HJ322E	1,2	143	-	123	139	227	-	2,5	2,5	14	
240	50	3	3	451	524,5	2400	2800	N322EM	11,3	-	-	-	211	123	-	227	215	2,5	2,5	-	
240	50	3	3	451	524,5	2400	2800	NF322EM	11,3	-	-	-	211	123	208	227	215	2,5	2,5	-	
240	80	3	3	618,7	785,6	2400	2800	NU2322M	17	HJ2322E	1,25	143	-	123	139	227	-	2,5	2,5	14	

SINGLE ROW CYLINDRICAL ROLLER BEARINGS ZVL SLOVAKIA, a. s.

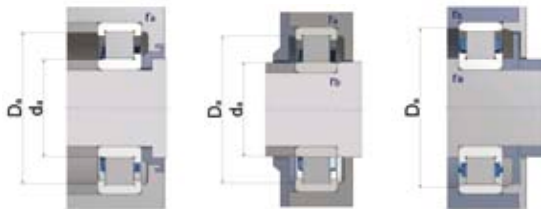

DIMENSIONS mm					BASIC LOAD RATING kN	LIMITING SPEED FOR LUBRICATION min ⁻¹		BEARING DESIGNATION	WEIGHT kg	ANGLE RING		ABUTMENT AND FILLET DIMENSIONS									
d	D	B	rs min.	r1s min.		C	Co			Fw	Ew	da min	da max	Da max	Da min	ra max	rb max	b			
110	240	80	3	3	618,7	785,6	2400	2800	NJ2322M	17	HJ2322E	1,25	143	-	123	139	227	-	2,5	2,5	14
	240	80	3	3	618,7	785,6	2400	2800	NUP2322M	17,5	HJ2322E	1,25	143	-	123	139	227	-	2,5	2,5	14
	240	80	3	3	618,7	785,6	2400	2800	N2322M	17	-	-	-	211	123	-	227	215	2,5	2,5	-
	240	80	3	3	618,7	785,6	2400	2800	NF2322M	17	-	-	-	211	123	208	227	215	2,5	2,5	-
	240	80	3	3	618,7	785,6	2400	2800	NU2322E	16,8	HJ2322E	1,25	143	-	123	139	227	-	2,5	2,5	14
	240	80	3	3	618,7	785,6	2400	2800	NJ2322E	16,8	HJ2322E	1,25	143	-	123	139	227	-	2,5	2,5	14
	240	80	3	3	618,7	785,6	2400	2800	NUP2322E	17,3	HJ2322E	1,25	143	-	123	139	227	-	2,5	2,5	14
	240	80	3	3	618,7	785,6	2400	2800	N2322E	16,8	-	-	-	211	123	-	227	215	2,5	2,5	-
	240	80	3	3	618,7	785,6	2400	2800	NF2322E	16,8	-	-	-	211	123	208	227	215	2,5	2,5	-
	280	65	4	4	547,8	621,1	2100	2500	HJ422	19,8	HJ422	2,15	155	-	126	150	264	-	3	3	17
	280	65	4	4	547,8	621,1	2100	2500	NU422M	21	HJ422	2,15	155	-	126	150	264	-	3	3	17
	280	65	4	4	547,8	621,1	2100	2500	NJ422M	21,9	HJ422	2,15	155	-	126	150	264	-	3	3	17
	280	65	4	4	547,8	621,1	2100	2500	N422M	19,8	-	-	-	235	126	-	264	261	3	3	-
	280	65	4	4	547,8	621,1	2100	2500	NF422M	21	-	-	-	235	126	232	264	261	3	3	-
120	215	40	2,1	2,1	339,2	428,1	2800	3400	NU224E	5,75	HJ224E	0,69	143,5	-	131	140	204	-	2	2	11
	215	40	2,1	2,1	339,2	428,1	2800	3400	NJ224E	5,85	HJ224E	0,69	143,5	-	131	140	204	-	2	2	11
	215	40	2,1	2,1	339,2	428,1	2800	3400	NUP224E	6	HJ224E	0,69	143,5	-	131	140	204	-	2	2	11
	215	40	2,1	2,1	339,2	428,1	2800	3400	N224E	5,75	-	-	-	195,5	131	-	204	199	2	2	-
	215	40	2,1	2,1	339,2	428,1	2800	3400	NF224E	5,85	-	-	-	195,5	131	192	204	199	2	2	-
	215	40	2,1	2,1	339,2	428,1	2800	3400	NU224EDM	6,25	HJ224E	0,69	143,5	-	131	140	204	-	2	2	11
	215	40	2,1	2,1	339,2	428,1	2800	3400	NJ224EDM	6,35	HJ224E	0,69	143,5	-	131	140	204	-	2	2	11
	215	40	2,1	2,1	339,2	428,1	2800	3400	NUP224EDM	6,5	HJ224E	0,69	143,5	-	131	140	204	-	2	2	11
	215	40	2,1	2,1	339,2	428,1	2800	3400	N224EDM	6,25	-	-	-	195,5	131	-	204	199	2	2	-
	215	40	2,1	2,1	339,2	428,1	2800	3400	NF224EDM	6,35	-	-	-	195,5	131	192	204	199	2	2	-
	215	58	2,1	2,1	426,5	573,4	2800	3400	NU224AM	8,3	HJ224	0,74	143,5	-	131	140	204	-	2	2	11
	215	58	2,1	2,1	426,5	573,4	2800	3400	NJ224AM	8,5	HJ224	0,74	143,5	-	131	140	204	-	2	2	11
	215	58	2,1	2,1	426,5	573,4	2800	3400	NUP224AM	8,65	HJ224	0,74	143,5	-	131	140	204	-	2	2	11
	215	58	2,1	2,1	426,5	573,4	2800	3400	N2224M	8,3	-	-	-	195,5	131	-	204	199	2	2	-
	215	58	2,1	2,1	426,5	573,4	2800	3400	NF2224M	8,5	-	-	-	195,5	131	192	204	199	2	2	-
	215	58	2,1	2,1	446,3	609,2	2800	3400	NU224EDM	8,3	HJ224E	0,74	143,5	-	131	140	204	-	2	2	11
	215	58	2,1	2,1	446,3	609,2	2800	3400	NJ224EDM	8,5	HJ224E	0,74	143,5	-	131	140	204	-	2	2	11
	215	58	2,1	2,1	446,3	609,2	2800	3400	NUP224EDM	8,65	HJ224E	0,74	143,5	-	131	140	204	-	2	2	11
	215	58	2,1	2,1	446,3	609,2	2800	3400	N224EDM	8,3	-	-	-	195,5	131	-	204	199	2	2	-
	215	58	2,1	2,1	446,3	609,2	2800	3400	NF224EDM	8,5	-	-	-	195,5	131	192	204	199	2	2	-
	260	55	3	3	528	610,2	2200	2600	NU324EM	14,7	HJ324E	1,4	154	-	133	150	247	-	2,5	2,5	14
	260	55	3	3	528	610,2	2200	2600	NJ324EM	14,7	HJ324E	1,4	154	-	133	150	247	-	2,5	2,5	14
	260	55	3	3	528	610,2	2200	2600	NUP324EM	15,2	HJ324E	1,4	154	-	133	150	247	-	2,5	2,5	14
	260	55	3	3	528	610,2	2200	2600	N234EM	14,7	-	-	-	230	133	-	247	234	2,5	2,5	-
	260	55	3	3	528	610,2	2200	2600	NF324EM	14,7	-	-	-	230	133	226	247	234	2,5	2,5	-
	260	86	3	3	771,5	993,7	2100	2500	NU2324EM	24	HJ324E	1,4	154	-	133	150	247	-	2,5	2,5	14
	260	86	3	3	771,5	993,7	2100	2500	NJ2324EM	24,5	HJ324E	1,4	154	-	133	150	247	-	2,5	2,5	14
	260	86	3	3	771,5	993,7	2100	2500	NUP2324EM	25	HJ324E	1,4	154	-	133	150	247	-	2,5	2,5	14
	260	86	3	3	771,5	993,7	2100	2500	N2324EM	24	-	-	-	230	133	-	247	234	2,5	2,5	-
260	86	3	3	771,5	993,7	2100	2500	NF2324EM	24,5	-	-	-	230	133	226	247	234	2,5	2,5	-	
310	72	5	5	714,4	834,5	1900	2200	NU424M	28	HJ424	2,6	170	-	140	165	290	-	4	4	17	
310	72	5	5	714,4	834,5	1900	2200	NJ424M	28,5	HJ424	2,6	170	-	140	165	290	-	4	4	17	
310	72	5	5	714,4	834,5	1900	2200	NUP424M	30	HJ424	2,6	170	-	140	165	290	-	4	4	17	
310	72	5	5	714,4	834,5	1900	2200	N424M	28	-	-	-	260	140	-	290	287	4	4	-	
310	72	5	5	714,4	834,5	1900	2200	NF424M	28,5	-	-	-	260	140	256	290	287	4	4	-	
130	230	40	3	3	367,4	460,5	2500	3000	NU226E	6,45	HJ226E	0,75	153,5	-	143	150	217	-	2,5	2,5	11
	230	40	3	3	367,4	460,5	2500	3000	NJ226E	6,6	HJ226E	0,75	153,5	-	143	150	217	-	2,5	2,5	11
	230	40	3	3	367,4	460,5	2500	3000	NUP226E	6,7	HJ226E	0,75	153,5	-	143	150	217	-	2,5	2,5	11
	230	40	3	3	367,4	460,5	2500	3000	N226E	6,45	-	-	-	209,5	143	-	217	213	2,5	2,5	-



SINGLE ROW CYLINDRICAL ROLLER BEARINGS ZVL SLOVAKIA, a. s.

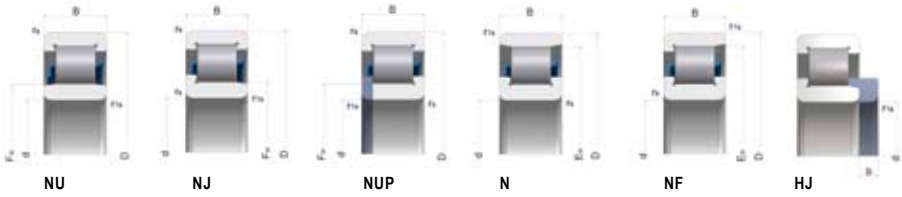

DIMENSIONS mm					BASIC LOAD RATING kN		LIMITING SPEED FOR LUBRICATION min ⁻¹		BEARING DESIGNATION	WEIGHT kg	ANGLE RING		ABUTMENT AND FILLET DIMENSIONS								
d	D	B	rs min.	r1s min.	C	Co	n	N	W	α	β	Fw	Ew	da	da	Da	Da	ra	rb	b	
														min	max	max	min	max	max		
130	230	40	3	3	367,4	460,5	2500	3000	NF228E	6,6	-	-	-	209,5	143	206	217	213	2,5	2,5	-
	230	40	3	3	351,1	433,5	2500	3000	NU228EM	7,05	HJ228E	0,75	153,5	-	143	150	217	-	2,5	2,5	11
	230	40	3	3	351,1	433,5	2500	3000	NJ228EM	7,2	HJ228E	0,75	153,5	-	143	150	217	-	2,5	2,5	11
	230	40	3	3	351,1	433,5	2500	3000	NUP228EM	7,3	HJ228E	0,75	153,5	-	143	150	217	-	2,5	2,5	11
	230	40	3	3	351,1	433,5	2500	3000	N228EM	7,05	-	-	-	209,5	143	-	217	213	2,5	2,5	-
	230	40	3	3	351,1	433,5	2500	3000	NF228EM	7,2	-	-	-	209,5	143	206	217	213	2,5	2,5	-
	230	64	3	3	490,8	666,8	2500	3000	NU2226M	7,05	HJ2226	0,83	153,5	-	143	150	217	-	2,5	2,5	11
	230	64	3	3	490,8	666,8	2500	3000	NJ2226M	7,2	HJ2226	0,83	153,5	-	143	150	217	-	2,5	2,5	11
	230	64	3	3	490,8	666,8	2500	3000	NUP2226M	7,3	HJ2226	0,83	153,5	-	143	150	217	-	2,5	2,5	11
	230	64	3	3	490,8	666,8	2500	3000	N2226M	7,05	-	-	-	209,5	143	-	217	213	2,5	2,5	-
	230	64	3	3	490,8	666,8	2500	3000	NF2226M	7,2	-	-	-	209,5	143	206	217	213	2,5	2,5	-
	280	58	4	4	582,8	683	1900	2400	NU328EM	18,5	HJ328E	1,6	167	-	146	163	264	-	3	3	14
	280	58	4	4	582,8	683	1900	2400	NJ328EM	19	HJ328E	1,6	167	-	146	163	264	-	3	3	14
	280	58	4	4	582,8	683	1900	2400	NUP328EM	19,5	HJ328E	1,6	167	-	146	163	264	-	3	3	14
	280	58	4	4	582,8	683	1900	2400	N328EM	18,5	-	-	-	247	146	-	264	251	3	3	-
	280	58	4	4	582,8	683	1900	2400	NF328EM	19	-	-	-	247	146	243	264	251	3	3	-
	280	93	4	4	848,9	1107,5	1900	2400	NU328M	30	HJ328E	1,7	167	-	146	163	264	-	3	3	14
	280	93	4	4	848,9	1107,5	1900	2400	NJ328M	30,5	HJ328E	1,7	167	-	146	163	264	-	3	3	14
280	93	4	4	848,9	1107,5	1900	2400	NUP328M	31	HJ328E	1,7	167	-	146	163	264	-	3	3	14	
280	93	4	4	848,9	1107,5	1900	2400	N328M	30	-	-	-	247	146	-	264	251	3	3	-	
280	93	4	4	848,9	1107,5	1900	2400	NF328M	30,5	-	-	-	247	146	243	264	251	3	3	-	
140	250	42	3	3	387,4	503,1	2400	2900	NU228E	8,3	HJ228E	0,96	169	-	153	166	237	-	2,5	2,5	11
	250	42	3	3	387,4	503,1	2400	2900	NJ228E	8,5	HJ228E	0,96	169	-	153	166	237	-	2,5	2,5	11
	250	42	3	3	387,4	503,1	2400	2900	NUP228E	8,65	HJ228E	0,96	169	-	153	166	237	-	2,5	2,5	11
	250	42	3	3	387,4	503,1	2400	2900	N228E	8,3	-	-	-	225	153	-	237	229	2,5	2,5	-
	250	42	3	3	387,4	503,1	2400	2900	NF228E	8,5	-	-	-	225	153	222	237	229	2,5	2,5	-
	250	42	3	3	387,4	503,1	2400	2900	NU228EM	9	HJ228E	0,96	169	-	153	166	237	-	2,5	2,5	11
	250	42	3	3	387,4	503,1	2400	2900	NJ228EM	9,15	HJ228E	0,96	169	-	153	166	237	-	2,5	2,5	11
	250	42	3	3	387,4	503,1	2400	2900	NUP228EM	9,3	HJ228E	0,96	169	-	153	166	237	-	2,5	2,5	11
	250	42	3	3	387,4	503,1	2400	2900	N228EM	9	-	-	-	225	153	-	237	229	2,5	2,5	-
	250	42	3	3	387,4	503,1	2400	2900	NF228EM	9,15	-	-	-	225	153	222	237	229	2,5	2,5	-
	250	68	3	3	510,7	718,7	2400	2900	NU2228M	13	HJ2228	1,05	169	-	153	166	237	-	2,5	2,5	11
	250	68	3	3	510,7	718,7	2400	2900	NJ2228M	13,5	HJ2228	1,05	169	-	153	166	237	-	2,5	2,5	11
	250	68	3	3	510,7	718,7	2400	2900	NUP2228M	14	HJ2228	1,05	169	-	153	166	237	-	2,5	2,5	11
	250	68	3	3	510,7	718,7	2400	2900	N2228M	13	-	-	-	225	153	-	237	229	2,5	2,5	-
	250	68	3	3	510,7	718,7	2400	2900	NF2228M	13,5	-	-	-	225	153	222	237	229	2,5	2,5	-
	300	62	4	4	629,3	766,1	1800	2300	NU328M	22,5	HJ328	2	180	-	156	176	284	-	3	3	15
	300	62	4	4	629,3	766,1	1800	2300	NJ328M	23	HJ328	2	180	-	156	176	284	-	3	3	15
	300	62	4	4	629,3	766,1	1800	2300	NUP328M	23,5	HJ328	2	180	-	156	176	284	-	3	3	15
300	62	4	4	629,3	766,1	1800	2300	N328M	22,5	-	-	-	260	156	-	284	264	3	3	-	
300	62	4	4	629,3	766,1	1800	2300	NF328M	23	-	-	-	260	156	256	284	264	3	3	-	
150	270	45	3	3	435	571	2200	2700	NU230EM	11,2	HJ230E	1,25	182	-	163	178	257	-	2,5	2,5	12
	270	45	3	3	435	571	2200	2700	NJ230EM	11,5	HJ230E	1,25	182	-	163	178	257	-	2,5	2,5	12
	270	45	3	3	435	571	2200	2700	NUP230EM	11,8	HJ230E	1,25	182	-	163	178	257	-	2,5	2,5	12
	270	45	3	3	435	571	2200	2700	N230EM	11,2	-	-	-	242	163	-	257	246	2,5	2,5	-
	270	45	3	3	435	571	2200	2700	NF230EM	11,5	-	-	-	242	163	238	257	246	2,5	2,5	-
	270	73	3	3	618,2	897,5	2200	2700	NU2230EDM	18,5	HJ2230E	1,35	182	-	163	178	257	-	2,5	2,5	12
	270	73	3	3	618,2	897,5	2200	2700	NJ2230EDM	19	HJ2230E	1,35	182	-	163	178	257	-	2,5	2,5	12
	270	73	3	3	618,2	897,5	2200	2700	NUP2230EDM	19,5	HJ2230E	1,35	182	-	163	178	257	-	2,5	2,5	12
	270	73	3	3	618,2	897,5	2200	2700	N2230EDM	18,5	-	-	-	242	163	-	257	246	2,5	2,5	-
	270	73	3	3	618,2	897,5	2200	2700	NF2230EDM	19	-	-	-	242	163	238	257	246	2,5	2,5	-
	320	65	4	4	757,6	921,6	1700	2100	NU330EM	28	HJ330E	2,3	193	-	166	189	304	-	3	3	15
	320	65	4	4	757,6	921,6	1700	2100	NJ330EM	28,5	HJ330E	2,3	193	-	166	189	304	-	3	3	15

SINGLE ROW CYLINDRICAL ROLLER BEARINGS ZVL SLOVAKIA, a. s.

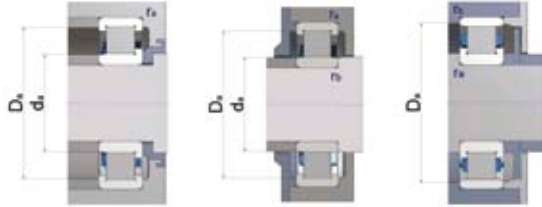

DIMENSIONS mm				BASIC LOAD RATING kN		LIMITING SPEED FOR LUBRICATION min ⁻¹		BEARING DESIGNATION	WEIGHT kg	ANGLE RING		ABUTMENT AND FILLET DIMENSIONS									
d	D	B	rs min.	r1s min.	C	Co					Fw	Ew	da	da	Da	Da	ra	rb	b		
													min	max	min	max	min	max			
150	320	65	4	4	757,6	921,6	1700	2100	NUP330EM	29	HJ330E	2,3	193	-	166	189	304	-	3	3	15
	320	65	4	4	757,6	921,6	1700	2100	N330EM	28	-	-	-	283	166	-	304	287	3	3	-
	320	65	4	4	757,6	921,6	1700	2100	NF330EM	28,5	-	-	-	283	166	279	304	287	3	3	-
	320	108	4	4	1123	1528,6	1700	2100	NUP2330M	45	HJ2330	2,5	193	-	166	189	304	-	3	3	15
	320	108	4	4	1123	1528,6	1700	2100	NUP2330M	46	HJ2330M	2,5	193	-	166	189	304	-	3	3	15
	320	108	4	4	1123	1528,6	1700	2100	NUP2330M	46,5	HJ2330	2,5	193	-	166	189	304	-	3	3	15
	320	108	4	4	1123	1528,6	1700	2100	N2330M	45	-	-	-	283	166	-	304	287	3	3	-
	320	108	4	4	1123	1528,6	1700	2100	NF2330M	46	-	-	-	283	166	279	304	287	3	3	-
160	290	48	3	3	478,8	631,4	2000	2400	NU232EM	14,5	HJ232E	1,45	195	-	173	191	277	-	2,5	2,5	12
	290	48	3	3	478,8	631,4	2000	2400	NJ232EM	15	HJ232E	1,45	195	-	173	191	277	-	2,5	2,5	12
	290	48	3	3	478,8	631,4	2000	2400	NUP232EM	15,5	HJ232E	1,45	195	-	173	191	277	-	2,5	2,5	12
	290	48	3	3	478,8	631,4	2000	2400	N232EM	14,5	-	-	-	259	173	-	277	263	2,5	2,5	-
	290	48	3	3	478,8	631,4	2000	2400	NF232EM	15	-	-	-	259	173	255	277	263	2,5	2,5	-
	290	80	3	3	751,7	1081,1	2000	2400	NU2232M	24	HJ2232	1,55	195	-	173	191	277	-	2,5	2,5	12
	290	80	3	3	751,7	1081,1	2000	2400	NJ2232M	24,5	HJ2232	1,55	195	-	173	191	277	-	2,5	2,5	12
	290	80	3	3	751,7	1081,1	2000	2400	NUP2232M	25	HJ2232	1,55	195	-	173	191	277	-	2,5	2,5	12
	290	80	3	3	751,7	1081,1	2000	2400	N2232M	24	-	-	-	259	173	-	277	263	2,5	2,5	-
	290	80	3	3	751,7	1081,1	2000	2400	NF2232M	24,5	-	-	-	259	173	255	277	263	2,5	2,5	-
	340	68	4	4	811,5	978	1500	1800	NJ332M	32,5	HJ322	2,55	204	-	176	200	324	-	3	3	15
	340	68	4	4	811,5	978	1500	1800	NJ332M	33	HJ322	2,55	204	-	176	200	324	-	3	3	15
	340	68	4	4	811,5	978	1500	1800	NUP332M	33,5	HJ322	2,55	204	-	176	200	324	-	3	3	15
	340	68	4	4	811,5	978	1500	1800	N332M	32,5	-	-	-	300	176	-	324	305	3	3	-
340	68	4	4	811,5	978	1500	1800	NF332M	33	-	-	-	300	176	295	324	305	3	3	-	
170	310	52	4	4	577,9	757	1800	2200	NU234EM	19	HJ234E	1,65	207	-	186	203	294	-	3	3	12
	310	52	4	4	577,9	757	1800	2200	NJ234EM	19,5	HJ234E	1,65	207	-	186	203	294	-	3	3	12
	310	52	4	4	577,9	757	1800	2200	NUP234EM	20	HJ234E	1,65	207	-	186	203	294	-	3	3	12
	310	52	4	4	577,9	757	1800	2200	N234EM	19	-	-	-	279	186	-	294	283	3	3	-
	310	52	4	4	577,9	757	1800	2200	NF234EM	19,5	-	-	-	279	186	275	294	283	3	3	-
	360	72	4	4	927,9	1152,5	1400	1700	NJ334EM	38	HJ334E	3,3	218	-	186	214	344	-	3	3	16
	360	72	4	4	927,9	1152,5	1400	1700	NJ334EM	38,5	HJ334E	3,3	218	-	186	214	344	-	3	3	16
	360	72	4	4	927,9	1152,5	1400	1700	NUP334EM	39	HJ334E	3,3	218	-	186	214	344	-	3	3	16
	360	72	4	4	927,9	1152,5	1400	1700	N334EM	38	-	-	-	318	186	-	344	323	3	3	-
	360	72	4	4	927,9	1152,5	1400	1700	NF334EM	38,5	-	-	-	318	186	314	344	323	3	3	-
	360	120	4	4	1366	1846	1400	1700	NU2334M	63	HJ2334	3,85	218	-	186	214	344	-	3	3	16
	360	120	4	4	1366	1846	1400	1700	NJ2334M	63,5	HJ2334	3,85	218	-	186	214	344	-	3	3	16
	360	120	4	4	1366	1846	1400	1700	NUP2334M	64	HJ2334	3,85	218	-	186	214	344	-	3	3	16
	360	120	4	4	1366	1846	1400	1700	N2334M	63	-	-	-	318	186	-	344	323	3	3	-
360	120	4	4	1366	1846	1400	1700	NF2334M	63,5	-	-	-	318	186	314	344	323	3	3	-	
180	320	52	4	4	601,2	807	1700	2000	NU236EM	19,5	HJ236E	1,7	217	-	196	213	304	-	3	3	12
	320	52	4	4	601,2	807	1700	2000	NJ236EM	20	HJ236E	1,7	217	-	196	213	304	-	3	3	12
	320	52	4	4	601,2	807	1700	2000	NUP236EM	21	HJ236E	1,7	217	-	196	213	304	-	3	3	12
	320	52	4	4	601,2	807	1700	2000	N236EM	19,5	-	-	-	289	196	-	304	294	3	3	-
	320	52	4	4	601,2	807	1700	2000	NF236EM	20	-	-	-	289	196	284	304	294	3	3	-
	380	75	4	4	984,1	1228,9	1300	1600	NU336M	40,5	HJ336	3,95	231	-	195	225	364	-	3	3	17
	380	75	4	4	984,1	1228,9	1300	1600	NJ336M	41,5	HJ336	3,95	231	-	195	225	364	-	3	3	17
	380	75	4	4	984,1	1228,9	1300	1600	NUP336M	42,5	HJ336	3,95	231	-	195	225	364	-	3	3	17
380	75	4	4	984,1	1228,9	1300	1600	N336M	40,5	-	-	-	335	195	-	364	340	3	3	-	
380	75	4	4	984,1	1228,9	1300	1600	NF336M	41,5	-	-	-	335	195	330	364	340	3	3	-	
220	400	65	4	4	905,5	1251,2	1500	1800	NU244EM	37,5	HJ244E	3,65	268	-	234	261	384	-	3	3	15
	400	65	4	4	905,5	1251,2	1500	1800	NJ244EM	38,5	HJ244E	3,65	268	-	234	261	384	-	3	3	15
	400	65	4	4	905,5	1251,2	1500	1800	NUP244EM	39,5	HJ244E	3,65	268	-	234	261	384	-	3	3	15
	400	65	4	4	905,5	1251,2	1500	1800	N244EM	37,5	-	-	-	358	234	-	384	364	3	3	-
	400	65	4	4	905,5	1251,2	1500	1800	NF244EM	38,5	-	-	-	358	234	353	384	364	3	3	-





FULL COMPLEMENT CYLINDRICAL ROLLER BEARINGS

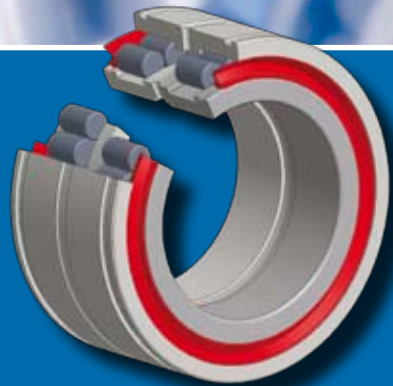

FULL COMPLEMENT CYLINDRICAL ROLLER BEARINGS

Due to their design with small construction height compared to the width, full complement cylindrical roller bearings are able to carry high loads while having small housing dimensions.

Using maximum cylindrical rollers instead of the cage creates different kinematic conditions when transferring the load and thus the bearing cannot achieve the high speeds that are possible when using cylindrical roller bearings with cage. The range of single row, double row and sealed double row full complement cylindrical roller bearings is found in this catalogue. Full complement cylindrical roller bearings are suitable for arrangements, where are the high requirements for load transfer in connection with low rotation speed.



DESIGN SPECIFICATION

MAIN DIMENSIONS

Main dimensions of full complement cylindrical roller bearings are specified in the dimension tables and they are in accordance with the international standards ISO 15 with the exception of the NNF 50 range, where the width of the outer ring is 1 mm smaller. All other dimensions are the same.

STRUCTURE

Full complement cylindrical roller bearings have three main parts – the inner ring equipped with flanges, cylindrical rollers and the outer ring. According to the arrangement, snap rings, angle ring or seals are added.



THE FOLLOWING CONSTRUCTIONS ARE MOST COMMON

NCF

These are the most common full complement cylindrical roller bearings. The inner ring has two flanges, the outer ring has one flange on one side and a snap ring, which keeps the bearing assembled on the other side. NCF bearings are able to carry axial load from one side as they are able to accommodate certain minor axial displacement of the shaft. The permissible values for this displacement are in the dimension tables.

DOUBLE ROW BEARINGS

Double row full complement cylindrical roller bearings are all supplied with a lubrication groove with holes in the outer ring, which enables full lubrication access into the rolling space of each row of cylindrical rollers.

The inner ring of the NNC, NNCL and NNCF design has three guiding flanges to ensure guiding accuracy of cylindrical rollers. They differentiate by the number of guiding flanges and snap rings in the outer ring. These components stop the rolling elements from falling out.

NNCL

NNCL bearings have the flangeless outer ring therefore certain axial bearing rings displacement against each other is accommodated.

NNCF

The outer ring has one flange and one snap ring. These components accommodate axial load transfer in one direction and also certain shaft displacement of the housing.

NNC

One side of outer ring is equipped with guiding flange, the other side has snap ring to keep the cylindrical rollers in place. These bearings can carry the axial load in both directions.

NNF

NNF bearings are produced with guiding flanges in the two-piece inner ring, which is held together by a retaining ring. The outer ring has a guiding flange. These bearings can also carry the axial load in both directions and as per bigger distance between individual rows of cylindrical rollers, they can transfer a tilting moments. The outer ring of an NNF bearing is 1 mm narrower than the inner ring and has two snap ring grooves. These bearings are supplied as standard with seals on both sides and the inner space is filled with grease to enable the bearing operation in standard working conditions up to 110°C.

TOLERANCE

Full complement cylindrical roller bearings are produced as standard in tolerance class P0. Production of bearings with higher tolerance should be discussed in advance. Dimension tolerances are in accordance with the international standards and are stated in ISO 492 standard.

NNC design is the exception to above as it comes in various outer ring widths. They can vary up to double of the tolerance.

RADIAL CLEARANCE

Full complement cylindrical roller bearings are produced and supplied as standard in standard radial clearance or alternatively in C3 clearance. The radial clearance C2 (smaller than standard clearance), alternatively C4, C5 (greater than standard and C3 clearance). Radial clearance values are in accordance with the ISO 5753 standard. These values are applicable for manufactured and unassembled bearing.

STABILISATION FOR OPERATION AT HIGHER TEMPERATURE

For operating temperature higher than 120°C specially stabilized bearings with individually heat-treated components to ensure dimension and shape stability under long-term exposure to temperatures ranging from 150°C to 400°C (S0, S1, S2, S3 and S4) are supplied. Delivery of stabilized bearings should be discussed in advance.



MISALIGNMENT

The inner construction of rolling contact area allows the operation of cylindrical bearings with certain misalignment of both rings.

The standard values are:

3' - bearing series 18

2' - bearing series 22, 23, 29 and 30

EQUIVALENT DYNAMIC BEARING LOAD

If radial load is applied to the cylindrical bearing with no axial forces present, dynamic load is calculated as follows:

$$P = F_r$$

If both radial and axial load is applied on cylindrical bearing, dynamic load is calculated as follows:

$$P = F_r \quad \text{for } F_a/F_r \leq e$$

$$P = 0,92F_r + YF_a \quad \text{for } F_a/F_r > e$$

e = calculation coefficient

$e = 0,15$ for double row bearings

$e = 0,2$ for bearing series 18

$e = 0,3$ for other bearings

Y = axial load coefficient

$Y = 0,6$ for bearing series 18

$Y = 0,4$ for other bearings

Simultaneous radial load needs to be applied for trouble free operation of cylindrical bearings carrying axial load, where F_a/F_r ratio should not exceed the value 0,5.

EQUIVALENT STATIC BEARING LOAD

If static load is applied to the cylindrical bearing, then:

$$P_p = F_r$$

MINIMUM BEARING LOAD

Certain load should be applied on the bearings when in operation to allow their safe running. The required load is calculated as follows:

$$F_m = k_r \left(6 + \frac{4n}{n_r} \right) \left(\frac{d_m}{100} \right)^2$$

where

F_m	= minimum load
k_r	= minimum load coefficient
k_r	= 100 for bearing series 18
	= 200 for bearing series 29 and 48
	= 250 for bearing series 49
	= 300 for bearing series 22 and 30
	= 350 for bearing series 23
	= 400 for bearing series NNF 50
n	- operating speed
n_r	- permissible speed for oil lubrication
D_m	- bearing mean diameter

If the minimum load imposed by bearing seating components weight is not sufficient, a subsequent load needs to be applied in an appropriate fashion – by tensioning the V-belt, etc.

LIMITING SPEED

The limiting speed specified in this catalogue represents the maximum number of revolutions acceptable for bearing to be able to operate trouble-free at certain safety level.

AXIAL DYNAMIC LOAD RATING

The bearings are able to transfer also axial forces. The axial dynamic load rating is in this case determined by the load rating of the contact areas of the rolling element and the guiding flange. It can be calculated with sufficient accuracy as follows:

$$F_{ap} = \frac{k_1 C_0 10^4}{n (d + D)} - k_2 F_r$$

where

F_{ap}	= maximum permissible axial load
C_0	= static load rating
F_r	= effective radial load
N	= operating speed
d	= bore diameter
D	= outer diameter
K_1	= 1 for single row oil-lubricated bearings
K_1	= 0,5 for single row grease-lubricated bearings
K_2	= 0,3 for single row oil-lubricated bearings
K_2	= 0,15 for single row grease-lubricated bearings
K_1	= 0,35 for double row oil-lubricated bearings
K_1	= 0,2 for double row grease-lubricated bearings
K_2	= 0,1 for double row oil-lubricated bearings
K_2	= 0,06 for double row grease-lubricated bearings

The above calculation is applicable if the permanent axial force is applied.

The load rating figure can double if the force is applied for a short period of time and triple if the load is applied at once. The maximum force should not exceed following values:

1,2 D2 for permanent load
3,0 D2 for intermittent load

FULL COMPLEMENT CYLINDRICAL ROLLER BEARINGS ZVL SLOVAKIA, a. s.

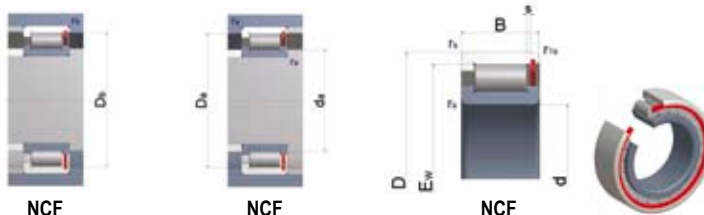

NCF

NCF

NCF

DIMENSIONS mm					BASIC LOAD RATING kN		LIMITING SPEED FOR LUBRICATION min ⁻¹		BEARING DESIGNATION	WEIGHT kg	ABUTMENT AND FILLET DIMENSIONS						
d	D	B	r _s min.	r _s min.	C	C ₀				E _w	s	da min	Da max	Db max	ra max	rb max	
20	37	11	0,3	0,3	16	17	3 500	8 500	NCF2904V	0,05	32,2	0,5	23	34	35	0,3	0,3
	42	16	0,6	0,3	28	28	3 500	8 500	NCF3004V	0,11	37,8	1,5	24	38	40	0,5	0,3
	47	18	1,1	0,6	30	39	3 300	8 600	NCF2204V	0,16	31,5	1,0	26	41	43	0,5	0,5
25	42	11	0,3	0,3	17	21	3 800	7 000	NCF2905V	0,06	37,3	0,5	27	40	41	0,3	0,3
	47	16	0,6	0,3	31	33	3 800	7 000	NCF3005V	0,12	31,95	1,5	29	43	45	0,5	0,3
	52	18	1,1	0,6	35	37	3 600	6 600	NCF2205V	0,18	36,6	1,0	30	47	48	0,5	0,5
30	47	11	0,3	0,3	19	25	3 200	6 000	NCF2906V	0,07	32,4	0,5	32	45	46	0,3	0,3
	55	19	1,1	0,6	30	35	3 200	6 000	NCF3006V	0,2	39,6	2,0	35	50	51	0,5	0,5
	62	20	1,1	0,6	61	66	3 000	5 500	NCF2206V	0,30	55,2	1,0	35	57	58	0,5	0,5
35	55	13	0,6	0,3	30	39	2 800	5 300	NCF2907V	0,12	39,8	0,5	39	51	53	0,5	0,3
	62	20	1,1	0,6	39	57	2 800	5 300	NCF3007V	0,26	55,55	2,0	40	57	58	0,5	0,5
	72	23	1,1	0,6	76	81	2 300	3 800	NCF2207V	0,33	63,0	1,0	40	67	68	0,5	0,5
40	62	13	0,6	0,3	33	35	2 300	3 800	NCF2908V	0,15	56,5	0,5	44	58	60	0,5	0,3
	68	21	1,1	0,6	58	70	2 300	3 800	NCF3008V	0,31	61,8	2,0	45	63	64	0,5	0,5
	80	23	1,1	0,6	83	93	2 000	3 500	NCF2208V	0,55	71,0	1,0	45	75	76	0,5	0,5
45	68	13	0,6	0,3	36	50	2 000	3 300	NCF2909V	0,18	61,8	0,5	49	64	66	0,5	0,3
	75	23	1,1	0,6	72	92	2 000	3 300	NCF3009V	0,3	68,35	2,0	50	70	71	0,5	0,5
	85	23	1,1	0,6	87	101	1 900	3 000	NCF2209V	0,59	73,5	1,0	50	80	81	0,5	0,5
50	72	13	0,6	0,3	38	56	1 900	3 000	NCF2910V	0,19	67,0	0,5	54	68	70	0,5	0,3
	80	23	1,1	0,6	76	102	1 900	3 000	NCF3010V	0,33	73,85	2,0	55	75	76	0,5	0,5
	90	23	1,1	0,6	93	113	1 700	3 600	NCF2210V	0,63	81,5	1,0	55	85	86	0,5	0,5
55	80	16	1,1	0,6	50	77	1 600	3 300	NCF2911V	0,27	73,1	0,5	60	75	76	0,5	0,5
	90	26	1,1	0,6	98	131	1 600	3 300	NCF3011V	0,63	83,7	2,0	60	85	86	0,5	0,5
	100	25	1,5	1,1	119	150	1 300	3 100	NCF2211V	0,87	89,0	1,0	63	92	95	1,1	0,5
60	85	16	1,1	0,6	55	83	1 600	3 300	NCF2912V	0,29	79,2	1,0	65	80	81	0,5	0,5
	95	26	1,1	0,6	101	138	1 600	3 300	NCF3012V	0,69	86,9	2,0	65	90	91	0,5	0,5
	110	28	1,5	1,1	138	183	1 300	3 100	NCF2212V	1,2	99,3	1,5	68	102	105	1,1	0,5
65	90	16	1,1	0,6	57	89	1 300	3 000	NCF2913V	0,31	83,3	1,0	70	85	86	0,5	0,5
	100	26	1,1	0,6	107	151	1 300	3 000	NCF3013V	0,73	93,3	2,0	70	95	96	0,5	0,5
	120	31	1,5	1,1	172	218	1 200	2 700	NCF2213V	1,6	106,6	1,5	73	112	115	1,1	0,5
70	100	19	1,1	0,6	77	118	1 300	3 000	NCF2913V	0,39	92,4	1,0	75	95	96	0,5	0,5
	110	30	1,1	0,6	133	179	1 300	3 000	NCF3013V	1,02	102,15	3,0	75	105	106	0,5	0,5
	125	31	1,5	1,1	179	232	1 100	2 600	NCF2213V	1,7	111,4	1,5	78	117	120	1,1	0,5
75	105	19	1,1	0,6	80	126	1 200	2 600	NCF2915V	0,52	97,4	1,0	80	100	101	0,5	0,5
	115	30	1,1	0,6	137	188	1 200	2 600	NCF3015V	1,06	106,05	3,0	80	110	111	0,5	0,5
	130	31	1,5	1,1	185	236	900	2 200	NCF2215V	1,8	116,2	1,5	83	122	125	1,1	0,5
80	110	19	1,1	0,6	83	133	1 200	2 600	NCF2916V	0,55	102,6	1,0	85	105	106	0,5	0,5
	125	33	1,1	0,6	168	230	1 100	2 300	NCF3016V	1,33	117,2	3,0	85	120	121	0,5	0,5
	130	33	2,1	1,5	218	286	900	2 200	NCF2216V	2,1	126,3	1,5	91	119	122	1,5	1,1
85	120	22	1,1	0,6	103	169	1 100	2 300	NCF2917V	0,81	112,5	1,0	90	115	116	0,5	0,5
	130	33	1,1	0,6	173	232	1 100	2 300	NCF3017V	1,51	121,6	3,0	90	125	126	0,5	0,5
	150	36	2,1	1,5	237	329	900	2 200	NCF2217V	2,7	133,7	1,5	96	139	142	1,5	1,1

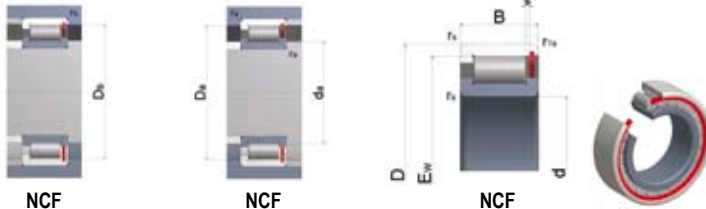

DIMENSIONS mm					BASIC LOAD RATING kN		LIMITING SPEED FOR LUBRICATION min ⁻¹		BEARING DESIGNATION	WEIGHT kg	ABUTMENT AND FILLET DIMENSIONS						
d	D	B	rs min.	r1s min.	C	Co				Ew	s	da min	Da max	Db max	ra max	rb max	
90	125	22	1,1	0,6	105	173	1 100	2 300	NCF2918V	0,83	115,4	1,0	95	120	121	0,5	0,5
	140	37	1,5	1,1	202	287	1 000	2 200	NCF3018V	1,97	130,3	3,0	98	132	135	1,1	0,5
	160	30	2,1	1,5	279	376	900	2 200	NCF2218V	3,5	131,2	2,5	101	149	152	1,5	1,1
100	130	23	1,1	0,6	125	209	1 000	2 200	NCF2920V	1,13	128,2	1,5	105	125	126	0,5	0,5
	150	37	1,5	0,6	212	313	950	2 000	NCF3020V	2,15	139,9	3,0	108	142	146	1,1	0,5
	180	36	2,1	1,5	380	530	850	1 800	NCF2220V	5,1	163,3	2,5	111	169	172	1,5	1,1
110	150	23	1,1	0,6	132	233	900	1 900	NCF2922V	1,23	130,9	1,5	115	145	146	0,5	0,5
	170	35	2,1	1,5	280	307	850	1 800	NCF3022V	3,5	156,3	5,5	121	159	162	1,5	1,1
	200	53	2,1	1,5	337	613	700	1 500	NCF2222V	7,2	178,2	3,0	121	189	192	1,5	1,1
120	165	27	1,1	0,6	177	303	850	1 800	NCF2923V	1,73	153,8	1,5	125	160	161	0,5	0,5
	180	36	2,1	1,5	293	336	800	1 700	NCF3023V	3,8	167,9	5,5	131	169	172	1,5	1,1
	215	58	2,1	1,5	519	732	700	1 500	NCF2223V	9,0	192,9	3,0	131	204	207	1,5	1,1
130	180	30	1,5	1,1	208	363	750	1 600	NCF2926V	2,33	166,6	2,0	138	172	175	1,1	0,5
	200	52	2,1	1,5	318	623	700	1 500	NCF3026V	5,8	183,2	5,5	141	189	192	1,5	1,1
	230	63	3	2,1	603	873	650	1 300	NCF2226V	11,2	207,8	5,0	143	217	219	2,1	1,5
140	190	30	1,5	1,1	225	392	700	1 500	NCF2928V	2,32	179,4	2,0	148	182	185	1,1	0,5
	210	53	2,1	1,5	331	686	670	1 300	NCF3028V	6,1	198,2	5,5	151	199	202	1,5	1,1
	250	68	3	2,1	697	1020	550	1 200	NCF2228V	13,3	222,6	5,0	153	237	239	2,1	1,5
150	190	20	1,1	0,6	108	197	700	1 500	NCF1830V	1,3	179,5	1,5	155	185	186	0,5	0,5
	210	36	2,1	1,5	293	512	670	1 300	NCF2930V	3,77	193,9	2,5	161	199	202	1,5	1,1
	225	56	2,1	1,5	363	717	630	1 300	NCF3030V	7,5	207,2	7,0	161	214	217	1,5	1,1
	270	73	3	2,1	797	1180	550	1 200	NCF2230V	18,3	237,3	6,0	163	257	269	2,1	1,5
160	200	20	1,1	0,6	112	209	670	1 300	NCF1832V	1,3	189,0	1,5	165	195	196	0,5	0,5
	220	36	2,1	1,5	302	533	630	1 300	NCF2932V	3	205,1	2,5	171	209	212	1,5	1,1
	230	60	2,1	1,5	530	628	600	1 200	NCF3032V	9,1	225,2	7,0	171	219	222	1,5	1,1
	290	80	3	2,1	988	1390	550	1 200	NCF2232V	23,0	267,1	6,0	173	277	279	2,1	1,5
170	215	22	1,1	0,6	139	272	630	1 300	NCF1833V	1,8	203,8	1,5	175	210	211	0,5	0,5
	230	36	2,1	1,5	311	576	600	1 200	NCF2933V	3,3	215,3	2,5	181	219	222	1,5	1,1
	260	67	2,1	1,5	681	1080	560	1 100	NCF3033V	12,5	233,3	7,0	181	249	252	1,5	1,1
	310	86	4	4	1090	1680	500	1 000	NCF2233V	28,7	281,9	7,0	176	294	194	3	3
180	225	22	1,1	0,6	153	290	600	1 200	NCF1836V	1,9	215,2	1,5	185	220	221	0,5	0,5
	250	32	2,1	1,5	397	709	560	1 100	NCF2936V	6,2	231,3	2,5	191	239	242	1,5	1,1
	280	73	2,1	1,5	788	1270	560	1 100	NCF3036V	16,5	260,7	7,0	191	269	269	1,5	1,5
	320	86	4	4	1130	1780	500	1 000	NCF2236V	29,8	293,0	7,0	196	304	304	3	3
190	230	23	1,5	1,1	176	330	560	1 100	NCF1838V	2,3	229,0	1,8	198	222	225	1,1	0,5
	260	32	2,1	1,5	310	753	560	1 100	NCF2938V	6,5	233,5	2,5	201	249	252	1,5	1,1
	290	75	2,1	2,1	809	1330	530	1 000	NCF3038V	17	270,2	9,0	201	279	279	1,5	1,5
	340	92	4	4	1230	1970	370	950	NCF2238V	35,7	309,5	7,0	206	324	324	3	3
200	250	23	1,5	1,1	179	333	560	1 100	NCF1840V	2,6	237,5	1,8	208	242	245	1,1	0,5
	280	38	2,1	1,5	398	923	530	1 000	NCF2940V	9,1	262,4	3,0	211	269	272	1,5	1,1
	310	82	2,1	2,1	925	1530	500	950	NCF3040V	22,5	288,2	9,0	211	299	299	1,5	1,5
	360	98	4	4	1390	2230	370	900	NCF2240V	33,1	325,0	7,0	216	344	344	3	3
220	270	23	1,5	1,1	188	377	530	1 000	NCF1844V	2,8	258,0	1,8	228	262	265	1,1	0,5
	300	38	2,1	1,5	522	1010	380	900	NCF2944V	9,9	282,5	3,0	231	289	292	1,5	1,1
	330	90	3	3	1110	1830	350	850	NCF3044V	29,5	312,7	9,0	233	317	317	2,1	2,1
	400	108	4	4	1720	2730	300	800	NCF2244V	58,0	356,2	8,0	236	384	384	3	3

FULL COMPLEMENT CYLINDRICAL ROLLER BEARINGS ZVL SLOVAKIA, a. s.

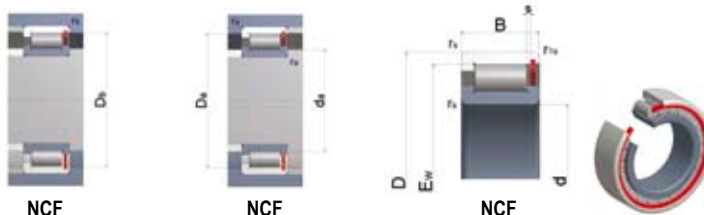

DIMENSIONS mm					BASIC LOAD RATING kN		LIMITING SPEED FOR LUBRICATION min ⁻¹		BEARING DESIGNATION	WEIGHT kg	ABUTMENT AND FILLET DIMENSIONS						
d	D	B	rs min.	r1s min.	C	Co				Ew	s	da min	Da max	Db max	ra max	rb max	
240	300	28	2,1	1,5	263	520	380	900	NCF1848V	3,3	287,0	1,8	241	289	292	1,5	1,1
	320	38	2,1	1,5	533	1090	350	850	NCF2948V	10,6	302,6	3,0	241	309	312	1,5	1,1
	360	92	3	3	1170	2010	330	800	NCF3048V	32	335,6	11,0	243	347	347	2,1	2,1
260	320	28	2,1	1,5	275	561	330	800	NCF1852V	3,7	307,2	1,8	271	309	312	1,5	1,1
	360	60	2,1	1,5	763	1390	300	750	NCF2952V	18,5	333,2	3,5	271	349	352	1,5	1,1
	400	103	3	3	1590	2630	380	700	NCF3052V	36,5	376,3	11,0	273	387	387	2,1	2,1
280	350	33	2,1	1,5	335	682	300	750	NCF1856V	7,1	333,0	2,5	291	339	342	1,5	1,1
	380	60	2,1	1,5	887	1750	380	700	NCF2956V	19,7	358,9	3,5	291	369	372	1,5	1,1
	420	106	3	3	1630	2770	360	670	NCF3056V	50	390,75	11,0	293	407	407	2,1	2,1
300	380	38	2,1	1,5	328	658	360	670	NCF1860V	10,0	363,0	3,0	311	369	372	1,5	1,1
	420	72	3	3	1130	2230	330	630	NCF2960V	31,2	389,7	5,0	313	407	407	2,1	2,1
	460	118	3	3	2000	3660	320	600	NCF3060V	69	332	13,0	313	447	447	2,1	2,1
320	400	38	2,1	1,5	332	912	330	630	NCF1864V	10,5	383,0	3,0	331	389	392	1,5	1,1
	440	72	3	3	1170	2380	320	600	NCF2964V	32,9	310,1	5,0	333	427	427	2,1	2,1
	480	121	3	3	2050	3720	300	560	NCF3064V	73,5	337,3	13,0	333	457	457	2,1	2,1
330	420	38	2,1	1,5	355	966	320	600	NCF1868V	11,0	303,0	3,0	341	409	412	1,5	1,1
	460	72	3	3	1210	2520	300	560	NCF2968V	35	330,4	5,0	343	447	447	2,1	2,1
	520	133	5	5	2310	3570	280	530	NCF3068V	100	381,8	13,0	350	500	500	4	4
360	440	38	2,1	1,5	368	1010	300	560	NCF1872V	11,5	323,0	3,5	371	429	432	1,5	1,1
	480	72	3	3	1230	2660	280	530	NCF2972V	36,5	350,9	5,0	373	467	467	2,1	2,1
	530	133	5	5	2330	3360	260	500	NCF3072V	105	503,2	13,0	380	460	460	4	4
380	480	46	2,1	1,5	650	1360	280	530	NCF1876V	19,5	357,5	3,5	391	469	472	1,5	1,1
	520	82	4	4	1390	3160	260	500	NCF2976V	52,5	383,3	5,0	396	504	504	2,1	2,1
	560	135	5	5	2500	3650	230	380	NCF3076V	110	520,3	13,0	400	540	540	4	4
400	500	46	2,1	1,5	663	1320	260	500	NCF1880V	20,5	373,0	3,5	411	489	492	1,5	1,1
	530	82	4	4	1530	3330	230	380	NCF2980V	53,5	507,2	5,0	416	524	524	3	3
	600	138	5	5	2980	5520	220	350	NCF3080V	135	559	13,0	420	580	580	4	4
420	520	46	2,1	1,5	683	1500	230	380	NCF1883V	21,0	399,0	3,5	431	509	512	1,5	1,1
	560	82	4	4	1570	3510	220	350	NCF2983V	57	530,2	5,0	436	544	544	3	3
	620	150	5	5	3050	5760	200	320	NCF3083V	150	578,1	15,0	440	600	600	4	4
440	540	46	2,1	1,5	697	1560	220	350	NCF1888V	22,0	515,6	3,5	451	529	532	1,5	1,1
	600	95	4	4	2030	3380	200	330	NCF2988V	80,5	565,0	6,0	456	584	584	2,1	2,1
	650	157	6	6	3300	6380	180	380	NCF3088V	175	616,6	16,0	466	624	624	5	5
460	580	56	3	2,1	935	2020	200	330	NCF1892V	33,0	553,0	5,0	473	567	569	2,1	1,5
	620	95	4	4	2070	3600	190	300	NCF2992V	83,5	578,4	6,0	476	604	604	3	3
	680	163	6	6	3680	6910	180	380	NCF3092V	195	633,5	16,0	486	654	654	5	5
480	600	56	3	2,1	965	2100	190	300	NCF1896V	35,5	573,5	5,0	493	587	589	2,1	1,5
	650	100	5	5	2310	5110	180	380	NCF2996V	98	605,4	7,0	500	630	630	4	4
	700	165	6	6	3770	7210	170	360	NCF3096V	205	655,2	16,0	496	674	674	5	5
500	620	56	3	2,1	985	2190	180	380	NCF18500V	36,5	593,0	5,0	513	607	609	2,1	1,5
	670	100	5	5	2380	5300	170	360	NCF29500V	100	633,0	7,0	520	650	650	4	4
	720	167	6	6	3850	7510	160	330	NCF30500V	215	676,8	16,0	526	694	694	5	5

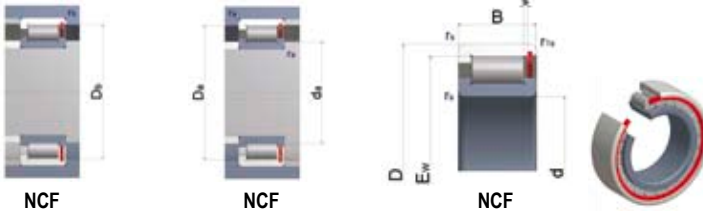

DIMENSIONS mm					BASIC LOAD RATING kN		LIMITING SPEED FOR LUBRICATION min ⁻¹		BEARING DESIGNATION	WEIGHT kg	ABUTMENT AND FILLET DIMENSIONS						
d	D	B	rs min.	r1s min.	C	Co					Ew	s	da min	Da max	Db max	ra max	rb max
530	650	56	3	2,1	1010	2310	170	360	NCF18/530V	38,5	623,5	5,0	543	637	639	2,1	1,5
	710	106	5	5	2730	6080	160	330	NCF29/530V	120	672,6	7,0	550	690	690	4	4
560	680	56	3	2,1	1030	2330	160	330	NCF18/560V	30,5	655,0	5,0	573	667	669	2,1	1,5
	750	112	5	5	3070	6790	150	320	NCF29/560V	130	709,2	7,0	580	730	730	4	4
600	730	60	3	2,1	1070	2610	150	320	NCF18/600V	51,5	696,0	7,0	613	717	719	2,1	1,5
	800	118	5	5	3390	7690	130	300	NCF29/600V	170	753,3	7,0	620	780	780	4	4
630	780	69	3	3	1290	3080	130	300	NCF18/630V	72,5	737,0	8,0	643	767	767	2,1	2,1
	850	128	6	6	3790	8650	120	280	NCF29/630V	205	807,1	8,0	656	824	824	5	5
670	820	69	3	3	1330	3290	130	280	NCF18/670V	76,5	783,0	8,0	683	807	807	2,1	2,1
	900	136	6	6	3150	9690	110	260	NCF29/670V	235	853,8	10,0	696	874	874	5	5
710	870	73	3	3	1590	3890	120	260	NCF18/710V	92,5	831,5	8,0	723	857	857	2,1	2,1
750	920	78	5	5	1790	3370	110	230	NCF18/750V	110,0	880,0	8,0	770	900	900	4	4
800	980	82	5	5	1970	3890	100	220	NCF18/800V	130,0	935,5	9,0	820	960	960	4	4
850	1030	82	5	5	2090	5290	90	210	NCF18/850V	135,0	985,7	9,0	870	1010	1010	4	4
900	1090	85	5	5	2280	5880	80	200	NCF18/900V	160,0	1033,0	9,0	920	1070	1070	4	4
950	1150	90	5	5	2390	6500	70	190	NCF18/950V	185,0	1103,5	10,0	970	1130	1130	4	4
1000	1220	100	6	6	2980	7680	60	180	NCF18/1000V	230,0	1165,0	12,0	1026	1094	1094	5	5



FULL COMPLEMENT CYLINDRICAL ROLLER BEARINGS ZVL SLOVAKIA, a. s.

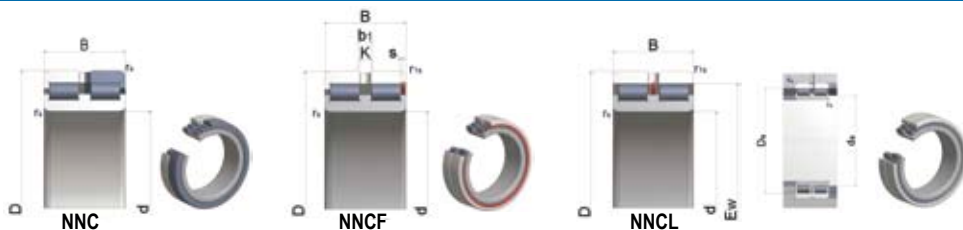

DIMENSIONS mm					BASIC LOAD RATING kN		LIMITING SPEED FOR LUBRICATION min ⁻¹		BEARING DESIGNATION	WEIGHT kg	ABUTMENT AND FILLET DIMENSIONS						
d	D	B	rs min.	r1s min.	C	Co					Ew	s	K	b1	da min	Da max	ra max
20	42	30	0,6	0,6	49	56	5 300	7 000	NNCF5004V	0,2	37,9	1,0	3,0	4,5	24	38	0,5
25	47	30	0,6	0,6	54	65	4 600	6 300	NNCF5005V	0,23	42,0	1,0	3,0	4,5	29	43	0,5
30	55	34	1	1	69	90	4 100	5 800	NNCF5006V	0,35	49,7	1,5	3,0	4,5	35	50	0,9
35	62	36	1	1	84	114	3 600	5 300	NNCF5007V	0,46	55,6	1,5	3,0	4,5	40	57	0,9
40	68	38	1	1	98	138	3 100	4 800	NNCF5008V	0,56	61,8	1,5	3,0	4,5	45	63	0,9
45	75	40	1	1	123	184	2 800	4 500	NNCF5009V	0,71	68,4	1,5	3,0	4,5	50	70	0,9
50	80	40	1	1	130	203	2 300	4 000	NNCF5010V	0,76	73,8	1,5	3,0	4,5	55	75	0,9
55	90	46	1,1	1,1	169	262	1 800	3 600	NNCF5011V	1,16	83,6	1,5	3,5	4,5	60	85	1
60	85	25	1	1	75	133	1 600	3 400	NNCF4912V	0,49	79	3,5	4,5	1,0	65	80	0,9
	85	25	1	1	75	133	1 600	3 400	NNCF4912V	0,49	79	3,5	4,5	-	65	80	0,9
	85	25	1	1	75	133	1 600	3 400	NNCL4912V	0,49	79	3,5	4,5	1,0	65	80	0,9
	95	46	1,1	1,1	174	276	1 600	3 400	NNCF5012V	1,24	86,8	1,5	3,5	4,5	65	90	1
65	100	46	1,1	1,1	183	302	1 300	3 000	NNCF5013V	1,32	93,2	1,5	3,5	4,5	71,5	93,5	1
70	100	30	1	1	107	198	1 300	3 000	NNCF4914V	0,78	92,2	3,5	4,5	1,0	75	95	0,9
	100	30	1	1	107	198	1 300	3 000	NNCF4914V	0,78	92,2	3,5	4,5	-	75	95	0,9
	100	30	1	1	107	198	1 300	3 000	NNCL4914V	0,78	92,2	3,5	4,5	1,0	75	95	0,9
	110	54	1,1	1,1	226	357	1 200	2 800	NNCF5014V	1,85	100,4	3,0	3,5	5,0	76,5	103,5	1
75	115	54	1,1	1,1	239	393	1 150	2 600	NNCF5015V	1,93	108,0	3,0	3,5	5,0	81,5	108,5	1
80	110	30	1	1	113	220	1 150	2 600	NNCF4916V	0,88	101,1	3,5	5,0	1,0	85	105	0,9
	110	30	1	1	113	220	1 150	2 600	NNCF4916V	0,88	101,1	3,5	5,0	-	85	105	0,9
	110	30	1	1	113	220	1 150	2 600	NNCL4916V	0,88	101,1	3,5	5,0	1,0	85	105	0,9
	125	60	1,1	1,1	289	460	1 150	2 500	NNCF5016V	2,59	117,1	3,5	3,5	5,0	86,5	118,5	1
85	130	60	1,1	1,1	297	484	1 100	2 400	NNCF5017V	2,72	121,5	3,5	3,5	5,0	91,5	123,5	1
90	125	35	1,1	1,1	152	307	1 100	2 400	NNCF4918V	1,4	115,5	3,5	5,0	1,5	96,5	118,5	1
	125	35	1,1	1,1	152	307	1 100	2 400	NNCF4918V	1,4	115,5	3,5	5,0	-	96,5	118,5	1
	125	35	1,1	1,1	152	307	1 100	2 400	NNCL4918V	1,4	115,5	3,5	5,0	1,5	96,5	118,5	1
	140	67	1,5	1,5	346	573	1 000	2 100	NNCF5018V	3,62	130,2	4,0	3,5	5,0	98	132	1,4
100	140	40	1,1	1,1	194	400	950	2 000	NNCF4920V	2	130	3,5	5,0	2,0	106,5	133,5	1
	140	40	1,1	1,1	194	400	950	2 000	NNCF4920V	2	130	3,5	5,0	-	106,5	133,5	1
	140	40	1,1	1,1	194	400	950	2 000	NNCL4920V	2	130	3,5	5,0	2,0	106,5	133,5	1
	150	67	1,5	1,5	364	628	950	2 000	NNCF5020V	3,94	139,7	4,0	3,5	6,0	108	142	1,4
110	150	40	1,1	1,1	202	431	950	2 000	NNCF4922V	2,2	138,6	3,5	6,0	2,0	116,5	143,5	1
	150	40	1,1	1,1	202	431	950	2 000	NNCF4922V	2,2	138,6	3,5	6,0	-	116,5	143,5	1
	150	40	1,1	1,1	202	431	950	2 000	NNCL4922V	2,2	138,6	3,5	6,0	2,0	116,5	143,5	1
	170	80	2	2	479	814	950	2 000	NNCF5022V	6,32	156,2	5,0	3,5	6,0	119	161	1,5
120	165	45	1,1	1,1	226	479	800	1 700	NNCF4924V	3	154	3,5	6,0	3,0	126,5	158,5	1
	165	45	1,1	1,1	226	479	800	1 700	NNCF4924V	3	154	3,5	6,0	-	126,5	158,5	1
	165	45	1,1	1,1	226	479	800	1 700	NNCL4924V	3	154	3,5	6,0	3,0	126,5	158,5	1
	180	80	2	2	505	891	800	1 700	NNCF5024V	6,77	167,7	5,0	3,5	6,0	129	171	1,5

FULL COMPLEMENT CYLINDRICAL ROLLER BEARINGS ZVL SLOVAKIA, a. s.

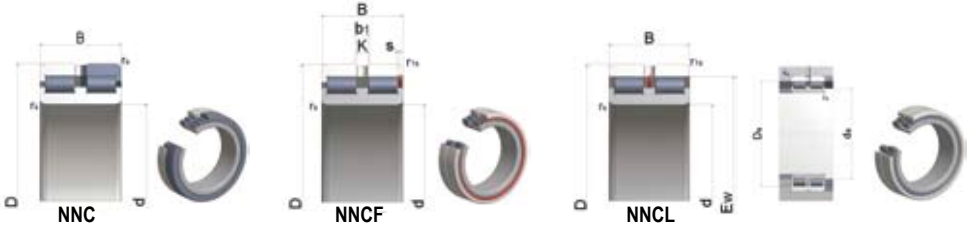

DIMENSIONS mm					BASIC LOAD RATING kN		LIMITING SPEED FOR LUBRICATION min ⁻¹		BEARING DESIGNATION	WEIGHT kg	ABUTMENT AND FILLET DIMENSIONS						
d	D	B	rs min.	rfs min.	C	Co					Ew	s	K	b ₁	d _a min	D _a max	r _a max
130	180	50	1,5	1,5	262	554	750	1 600	NNCF4926V	4	165,9	3,5	6,0	4,0	138	172	1,4
	180	50	1,5	1,5	262	554	750	1 600	NNCF4926V	4	165,9	3,5	6,0	-	138	172	1,4
	180	50	1,5	1,5	262	554	750	1 600	NNCL4926V	4	165,9	3,5	6,0	4,0	138	172	1,4
	200	95	2	2	717	1250	750	1 600	NNCF5026V	10,2	184,0	5,0	4,0	7,0	139	191	1,5
140	190	50	1,5	1,5	272	595	700	1 500	NNCF4928V	4,2	176,4	3,5	6,0	4,0	148	182	1,4
	190	50	1,5	1,5	272	595	700	1 500	NNCF4928V	4,2	176,4	3,5	6,0	-	148	182	1,4
	190	50	1,5	1,5	272	595	700	1 500	NNCL4928V	4,2	176,4	3,5	6,0	4,0	148	182	1,4
	210	95	2	2	756	1370	700	1 500	NNCF5028V	11,1	197,9	5,0	4,0	7,0	149	201	1,5
150	190	40	1,1	1,1	234	575	700	1 500	NNCF4830V	2,9	178,6	4,0	7,0	2,0	156,5	183,5	1
	190	40	1,1	1,1	234	575	700	1 500	NNCF4830V	2,9	178,6	4,0	7,0	-	156,5	183,5	1
	190	40	1,1	1,1	234	575	700	1 500	NNCL4830V	2,9	178,6	4,0	7,0	2,0	156,5	183,5	1
	210	60	2	2	389	858	670	1 400	NNCF4930V	6,7	191,9	4,0	7,0	4,0	159	201	1,5
	210	60	2	2	389	858	670	1 400	NNCF4930V	6,7	191,9	4,0	7,0	-	159	201	1,5
	210	60	2	2	389	858	670	1 400	NNCL4930V	6,7	191,9	4,0	7,0	4,0	159	201	1,5
160	225	100	2	2	793	1430	670	1 400	NNCF5030V	13,3	206,9	6,0	4,0	7,0	159	216	1,5
	200	40	1,1	1,1	243	616	670	1 400	NNCF4832V	3,1	190,1	4,0	7,0	2,0	166,5	193,5	1
	200	40	1,1	1,1	243	616	670	1 400	NNCF4832V	3,1	190,1	4,0	7,0	-	166,5	193,5	1
	200	40	1,1	1,1	243	616	670	1 400	NNCL4832V	3,1	190,1	4,0	7,0	2,0	166,5	193,5	1
	220	60	2	2	404	922	630	1 300	NNCF4932V	7	204,3	4,0	7,0	4,0	169	211	1,5
	220	60	2	2	404	922	630	1 300	NNCF4932V	7	204,3	4,0	7,0	-	169	211	1,5
170	210	60	2	2	404	922	630	1 300	NNCL4932V	7	204,3	4,0	7,0	4,0	169	211	1,5
	240	109	2,1	2,1	909	1660	630	1 300	NNCF5032V	16,2	224,9	6,0	4,0	7,0	171	229	1,5
	215	45	1,1	1,1	265	651	630	1 300	NNCF4834V	4,1	201,7	4,0	7,0	3,0	176,5	208,5	1
	215	45	1,1	1,1	265	651	630	1 300	NNCF4834V	4,1	201,7	4,0	7,0	-	176,5	208,5	1
	215	45	1,1	1,1	265	651	630	1 300	NNCL4834V	4,1	201,7	4,0	7,0	3,0	176,5	208,5	1
	230	60	2	2	414	965	600	1 150	NNCF4934V	7,4	212,6	4,0	7,0	4,0	179	221	1,5
180	230	60	2	2	414	965	600	1 150	NNCF4934V	7,4	212,6	4,0	7,0	-	179	221	1,5
	230	60	2	2	414	965	600	1 150	NNCL4934V	7,4	212,6	4,0	7,0	4,0	179	221	1,5
	260	122	2,1	2,1	1170	2160	600	1 150	NNCF5034V	23	243,0	6,0	4,0	7,0	181	249	1,5
	225	45	1,1	1,1	272	685	600	1 150	NNCF4836V	4,3	211,3	4,0	7,0	3,0	186,5	218,5	1
190	225	45	1,1	1,1	272	685	600	1 150	NNCF4836V	4,3	211,3	4,0	7,0	-	186,5	218,5	1
	225	45	1,1	1,1	272	685	600	1 150	NNCL4836V	4,3	211,3	4,0	7,0	3,0	186,5	218,5	1
	250	69	2	2	557	1240	550	1 100	NNCF4936V	10,8	231	4,0	7,0	4,0	189	241	1,5
	250	69	2	2	557	1240	550	1 100	NNCF4936V	10,8	231	4,0	7,0	-	189	241	1,5
	250	69	2	2	557	1240	550	1 100	NNCL4936V	10,8	231	4,0	7,0	4,0	189	241	1,5
	280	136	2,1	2,1	1350	2540	550	1 100	NNCF5036V	30,5	260,4	8,0	4,0	8,0	191	269	1,5
200	240	50	1,5	1,5	314	784	550	1 100	NNCF4838V	5,7	225,4	4,0	7,0	4,0	198	232	1,4
	240	50	1,5	1,5	314	784	550	1 100	NNCF4838V	5,7	225,4	4,0	7,0	-	198	232	1,4
	240	50	1,5	1,5	314	784	550	1 100	NNCL4838V	5,7	225,4	4,0	7,0	4,0	198	232	1,4
	260	69	2	2	572	1310	550	1 100	NNCF4938V	11,2	241,2	4,0	7,0	4,0	199	251	1,5
	260	69	2	2	572	1310	550	1 100	NNCF4938V	11,2	241,2	4,0	7,0	-	199	251	1,5
	260	69	2	2	572	1310	550	1 100	NNCL4938V	11,2	241,2	4,0	7,0	4,0	199	251	1,5
210	290	136	2,1	2,1	1390	2660	550	1 100	NNCF5038V	31,5	269,9	8,0	4,0	8,0	201	279	1,5
	250	50	1,5	1,5	322	825	550	1 100	NNCF4840V	5,9	236	4,0	7,0	4,0	208	242	1,4
	250	50	1,5	1,5	322	825	550	1 100	NNCF4840V	5,9	236	4,0	7,0	-	208	242	1,4
	250	50	1,5	1,5	322	825	550	1 100	NNCL4840V	5,9	236	4,0	7,0	4,0	208	242	1,4
	280	80	2,1	2,1	671	1510	530	1 000	NNCF4940V	15,8	259,9	4,0	8,0	5,0	211	269	2
	280	80	2,1	2,1	671	1510	530	1 000	NNCF4940V	15,8	259,9	4,0	8,0	-	211	269	2
220	280	80	2,1	2,1	671	1510	530	1 000	NNCL4940V	15,8	259,9	4,0	8,0	5,0	211	269	2
	310	150	2,1	2,1	1590	3080	530	1 000	NNCF5040V	41	287,9	9,0	4,0	8,0	211	299	2

FULL COMPLEMENT CYLINDRICAL ROLLER BEARINGS ZVL SLOVAKIA, a. s.

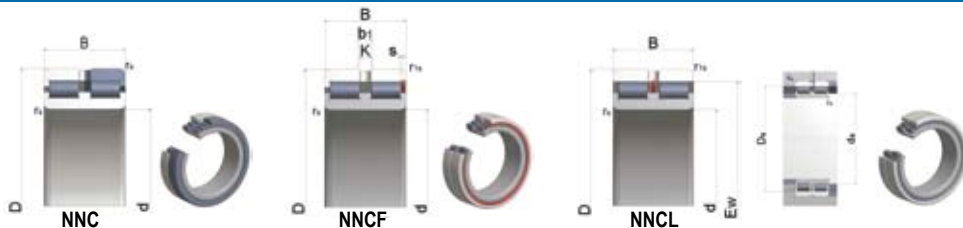

DIMENSIONS mm					BASIC LOAD RATING kN	LIMITING SPEED FOR LUBRICATION min ⁻¹		BEARING DESIGNATION	WEIGHT kg	ABUTMENT AND FILLET DIMENSIONS							
d	D	B	rs min.	rs max.	C	Co				Ew	s	K	b ₁	d _a min	D _a max	r _a max	
220	270	50	1,5	1,5	338	906	530	1 000	NNCF4844V	6,4	257	4,0	7,0	4,0	228	262	1,4
	270	50	1,5	1,5	338	906	530	1 000	NNCF4844V	6,4	257	4,0	7,0	-	228	262	1,4
	270	50	1,5	1,5	338	906	530	1 000	NNCL4844V	6,4	257	4,0	7,0	4,0	228	262	1,4
	300	80	2,1	2,1	697	1630	500	950	NNCF4944V	17,2	277,1	4,0	8,0	5,0	231	289	2
	300	80	2,1	2,1	697	1630	500	950	NNCF4944V	17,2	277,1	4,0	8,0	-	231	289	2
	300	80	2,1	2,1	697	1630	500	950	NNCL4944V	17,2	277,1	4,0	8,0	5,0	231	289	2
240	340	160	3	3	1900	3680	500	950	NNCF5044V	52,5	312,4	9,0	4,0	8,0	233	327	2,5
	300	60	2	2	506	1310	500	950	NNCF4848V	10	282,4	4,0	8,0	4,0	249	291	1,5
	300	60	2	2	506	1310	500	950	NNCF4848V	10	282,4	4,0	8,0	-	249	291	1,5
	300	60	2	2	506	1310	500	950	NNCL4848V	10	282,4	4,0	8,0	4,0	249	291	1,5
	320	80	2,1	2,1	731	1780	450	850	NNCF4948V	18,5	300	4,0	8,0	5,0	251	309	2
	320	80	2,1	2,1	731	1780	450	850	NNCF4948V	18,5	300	4,0	8,0	-	251	309	2
260	320	80	2,1	2,1	731	1780	450	850	NNCF4948V	18,5	300	4,0	8,0	-	251	309	2
	320	80	2,1	2,1	731	1780	450	850	NNCF4948V	18,5	300	4,0	8,0	5,0	251	309	2
	360	100	2,1	2,1	1080	2540	400	750	NNCF4952V	32	331,9	5,0	9,4	6,0	271	349	2
	360	100	2,1	2,1	1080	2540	400	750	NNCF4952V	32	331,9	5,0	9,4	-	271	349	2
	360	100	2,1	2,1	1080	2540	400	750	NNCL4952V	32	331,9	5,0	9,4	6,0	271	349	2
	400	190	4	4	2720	5270	400	750	NNCF5052V	85,5	376,2	9,0	5,0	9,4	276	384	3,5
280	350	69	2	2	691	1890	400	750	NNCF4856V	16	332,9	4,0	8,0	4,0	289	341	1,5
	350	69	2	2	691	1890	400	750	NNCF4856V	16	332,9	4,0	8,0	-	289	341	1,5
	350	69	2	2	691	1890	400	750	NNCL4856V	16	332,9	4,0	8,0	4,0	289	341	1,5
	380	100	2,1	2,1	1120	2740	380	700	NNCF4956V	34	353,9	5,0	9,4	6,0	291	369	2
	380	100	2,1	2,1	1120	2740	380	700	NNCF4956V	34	353,9	5,0	9,4	-	291	369	2
	380	100	2,1	2,1	1120	2740	380	700	NNCL4956V	34	353,9	5,0	9,4	6,0	291	369	2
300	420	190	4	4	2800	5540	370	690	NNCF5056V	90,5	390,5	9,0	5,0	9,4	296	404	3,5
	380	80	2,1	2,1	810	2170	380	700	NNCF4860V	23	357,3	5,0	9,4	6,0	311	369	2
	380	80	2,1	2,1	810	2170	380	700	NNCF4860V	23	357,3	5,0	9,4	-	311	369	2
	380	80	2,1	2,1	810	2170	380	700	NNCL4860V	23	357,3	5,0	9,4	6,0	311	369	2
	420	118	3	3	1560	3660	340	630	NNCF4960V	53	390,6	5,0	9,4	6,0	313	407	2,5
	420	118	3	3	1560	3660	340	630	NNCF4960V	53	390,6	5,0	9,4	-	313	407	2,5
320	420	118	3	3	1560	3660	340	630	NNCF4960V	53	390,6	5,0	9,4	-	313	407	2,5
	420	118	3	3	1560	3660	340	630	NNCF4960V	53	390,6	5,0	9,4	6,0	313	407	2,5
	460	218	4	4	3430	7110	340	630	NNCF5060V	130	431,8	9,0	5,0	9,4	316	444	3,5
	400	80	2,1	2,1	840	2330	340	630	NNCF4864V	24	380,2	5,0	9,4	6,0	331	389	2
	400	80	2,1	2,1	840	2330	340	630	NNCF4864V	24	380,2	5,0	9,4	-	331	389	2
	400	80	2,1	2,1	840	2330	340	630	NNCL4864V	24	380,2	5,0	9,4	6,0	331	389	2
340	440	118	3	3	1610	3860	320	600	NNCF4964V	56	409,1	5,0	9,4	6,0	333	427	2,5
	440	118	3	3	1610	3860	320	600	NNCF4964V	56	409,1	5,0	9,4	-	333	427	2,5
	440	118	3	3	1610	3860	320	600	NNCF4964V	56	409,1	5,0	9,4	6,0	333	427	2,5
	480	218	4	4	3510	7440	320	600	NNCF5064V	135	447,1	9,0	5,0	9,4	336	464	3,5
	420	80	2,1	2,1	861	2450	320	600	NNCF4868V	25,5	397,4	5,0	9,4	6,0	351	409	2
	420	80	2,1	2,1	861	2450	320	600	NNCF4868V	25,5	397,4	5,0	9,4	-	351	409	2
360	420	80	2,1	2,1	861	2450	320	600	NNCF4868V	25,5	397,4	5,0	9,4	6,0	351	409	2
	460	118	3	3	1650	4070	300	560	NNCF4968V	59	427,6	5,0	9,4	6,0	353	447	2,5
	460	118	3	3	1650	4070	300	560	NNCF4968V	59	427,6	5,0	9,4	-	353	447	2,5
	460	118	3	3	1650	4070	300	560	NNCF4968V	59	427,6	5,0	9,4	6,0	353	447	2,5
	460	118	3	3	1650	4070	300	560	NNCF4968V	59	427,6	5,0	9,4	-	353	447	2,5
	520	243	5	5	4140	9140	300	560	NNCF5068V	185	481,6	11,0	5,0	9,4	360	500	4,5



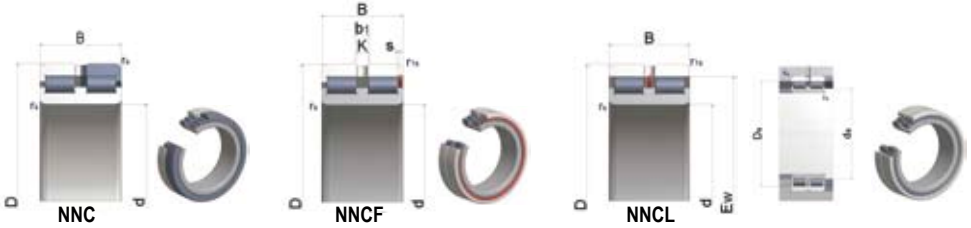



FULL COMPLEMENT CYLINDRICAL ROLLER BEARINGS ZVL SLOVAKIA, a. s.

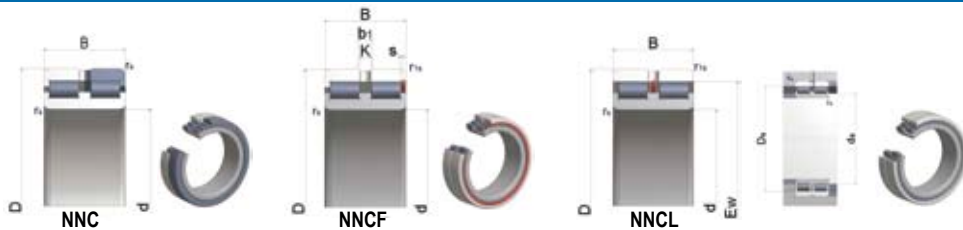

DIMENSIONS mm					BASIC LOAD RATING kN		LIMITING SPEED FOR LUBRICATION min ⁻¹		BEARING DESIGNATION	WEIGHT kg	ABUTMENT AND FILLET DIMENSIONS						
d	D	B	rs min.	rfs min.	C	Co					Ew	s	K	b ₁	d _a min	D _a max	r _a max
360	440	80	2,1	2,1	889	2600	300	560	NNCF4872V	27	420,4	5,0	9,4	6,0	371	429	2
	440	80	2,1	2,1	889	2600	300	560	NNCF4872V	27	420,4	5,0	9,4	-	371	429	2
	440	80	2,1	2,1	889	2600	300	560	NNCL4872V	27	420,4	5,0	9,4	6,0	371	429	2
	480	118	3	3	1700	4270	300	560	NNCF4972V	62	446,1	5,0	9,4	6,0	373	467	2,5
	480	118	3	3	1700	4270	300	560	NNCF4972V	62	446,1	5,0	9,4	-	373	467	2,5
	480	118	3	3	1700	4270	300	560	NNCL4972V	62	446,1	5,0	9,4	6,0	373	467	2,5
540	243	5	5	4390	9460	300	560	NNCF5072V	195	503,0	11,0	5,0	9,4	380	520	4,5	
380	480	100	2,1	2,1	1300	3660	280	530	NNCF4876V	46	456,4	5,0	9,4	6,0	391	469	2
	480	100	2,1	2,1	1300	3660	280	530	NNCF4876V	46	456,4	5,0	9,4	-	391	469	2
	480	100	2,1	2,1	1300	3660	280	530	NNCL4876V	46	456,4	5,0	9,4	6,0	391	469	2
	520	140	4	4	2210	5750	260	500	NNCF4976V	92,5	482	5,0	9,4	7,0	396	504	3,5
	520	140	4	4	2210	5750	260	500	NNCF4976V	92,5	482	5,0	9,4	-	396	504	3,5
	520	140	4	4	2210	5750	260	500	NNCL4976V	92,5	482	5,0	9,4	7,0	396	504	3,5
560	243	5	5	4490	9870	260	500	NNCF5076V	200	520,2	11,0	5,0	9,4	400	540	4,5	
400	500	100	2,1	2,1	1330	3790	260	500	NNCF4880V	48	471,1	5,0	9,4	6,0	411	489	2
	500	100	2,1	2,1	1330	3790	260	500	NNCF4880V	48	471,1	5,0	9,4	-	411	489	2
	500	100	2,1	2,1	1330	3790	260	500	NNCL4880V	48	471,1	5,0	9,4	6,0	411	489	2
	540	140	4	4	2270	6030	240	480	NNCF4980V	96,5	502,4	5,0	9,4	7,0	416	524	3,5
	540	140	4	4	2270	6030	240	480	NNCF4980V	96,5	502,4	5,0	9,4	-	416	524	3,5
	540	140	4	4	2270	6030	240	480	NNCL4980V	96,5	502,4	5,0	9,4	7,0	416	524	3,5
600	272	5	5	5320	11640	240	480	NNCF5080V	270	558,9	11,0	5,0	9,4	420	580	4,5	
420	520	100	2,1	2,1	1360	3990	240	480	NNCF4884V	50	493,1	5,0	9,4	6,0	431	509	2
	520	100	2,1	2,1	1360	3990	240	480	NNCF4884V	50	493,1	5,0	9,4	-	431	509	2
	520	100	2,1	2,1	1360	3990	240	480	NNCL4884V	50	493,1	5,0	9,4	6,0	431	509	2
	560	140	4	4	2330	6310	220	450	NNCF4984V	99,5	522,8	5,0	9,4	7,0	436	544	3,5
	560	140	4	4	2330	6310	220	450	NNCF4984V	99,5	522,8	5,0	9,4	-	436	544	3,5
	560	140	4	4	2330	6310	220	450	NNCL4984V	99,5	522,8	5,0	9,4	7,0	436	544	3,5
440	540	100	2,1	2,1	1400	4180	220	450	NNCF4888V	52	515,1	5,0	9,4	6,0	451	529	2
	540	100	2,1	2,1	1400	4180	220	450	NNCF4888V	52	515,1	5,0	9,4	-	451	529	2
	540	100	2,1	2,1	1400	4180	220	450	NNCL4888V	52	515,1	5,0	9,4	6,0	451	529	2
	600	160	4	4	2980	7540	200	430	NNCF4988V	137	564,1	5,0	9,4	7,0	456	584	3,5
	600	160	4	4	2980	7540	200	430	NNCF4988V	137	564,1	5,0	9,4	-	456	584	3,5
	600	160	4	4	2980	7540	200	430	NNCL4988V	137	564,1	5,0	9,4	7,0	456	584	3,5
460	580	118	3	3	1570	4680	200	430	NNCF4892V	76	543,9	5,0	9,4	7,0	473	567	2,5
	580	118	3	3	1570	4680	200	430	NNCF4892V	76	543,9	5,0	9,4	-	473	567	2,5
	580	118	3	3	1570	4680	200	430	NNCL4892V	76	543,9	5,0	9,4	7,0	473	567	2,5
	620	160	4	4	3020	7740	190	400	NNCF4992V	140	576,9	5,0	9,4	7,0	476	604	3,5
	620	160	4	4	3020	7740	190	400	NNCF4992V	140	576,9	5,0	9,4	-	476	604	3,5
	620	160	4	4	3020	7740	190	400	NNCL4992V	140	576,9	5,0	9,4	7,0	476	604	3,5
480	600	118	3	3	1610	4900	190	400	NNCF4896V	79	567,8	5,0	9,4	7,0	493	587	2,5
	600	118	3	3	1610	4900	190	400	NNCF4896V	79	567,8	5,0	9,4	-	493	587	2,5
	600	118	3	3	1610	4900	190	400	NNCL4896V	79	567,8	5,0	9,4	7,0	493	587	2,5
	650	170	5	5	3310	8560	180	380	NNCF4996V	165	605,8	5,0	9,4	8,0	500	630	4,5
	650	170	5	5	3310	8560	180	380	NNCF4996V	165	605,8	5,0	9,4	-	500	630	4,5
	650	170	5	5	3310	8560	180	380	NNCL4996V	165	605,8	5,0	9,4	8,0	500	630	4,5
500	620	118	3	3	1640	5060	180	380	NNCF48500V	82	583,8	5,0	9,4	7,0	513	607	2,5
	620	118	3	3	1640	5060	180	380	NNCF48500V	82	583,8	5,0	9,4	-	513	607	2,5
	620	118	3	3	1640	5060	180	380	NNCL48500V	82	583,8	5,0	9,4	7,0	513	607	2,5
	670	170	5	5	3400	9000	170	360	NNCF49500V	175	632,6	5,0	9,4	8,0	520	650	4,5
	670	170	5	5	3400	9000	170	360	NNCF49500V	175	632,6	5,0	9,4	-	520	650	4,5
	670	170	5	5	3400	9000	170	360	NNCL49500V	175	632,6	5,0	9,4	8,0	520	650	4,5

FULL COMPLEMENT CYLINDRICAL ROLLER BEARINGS ZVL SLOVAKIA, a. s.



DIMENSIONS mm					BASIC LOAD RATING kN		LIMITING SPEED FOR LUBRICATION min ⁻¹		BEARING DESIGNATION	WEIGHT kg	ABUTMENT AND FILLET DIMENSIONS						
d	D	B	rs min.	r1s min.							Ew	s	K	b ₁	d _a min	D _a max	r _a max
530	650	118	3	3	1690	5360	170	360	NNCF48/530V	86	615,7	5,0	9,4	7,0	543	637	2,5
	650	118	3	3	1690	5360	170	360	NNC48/530V	86	615,7	5,0	9,4	-	543	637	2,5
	650	118	3	3	1690	5360	170	360	NNCL48/530V	86	615,7	5,0	9,4	7,0	543	637	2,5
	710	180	5	5	3820	9910	160	350	NNCF49/530V	200	663,5	5,0	9,4	8,0	550	630	4,5
	710	180	5	5	3820	9910	160	350	NNC49/530V	200	663,5	5,0	9,4	-	550	630	4,5
	710	180	5	5	3820	9910	160	350	NNCL49/530V	200	663,5	5,0	9,4	8,0	550	630	4,9



DOUBLE ROW FULL COMPLEMENT CYLINDRICAL ROLLER BEARINGS ZVL SLOVAKIA, a. s.

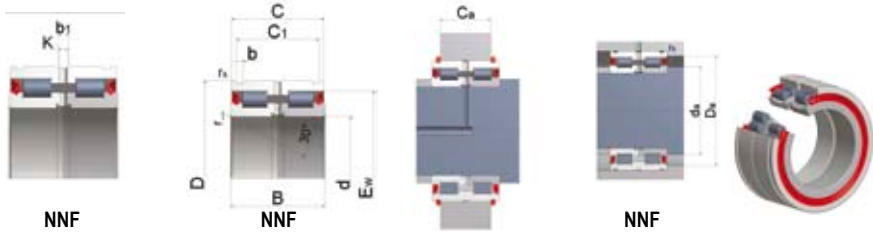

DIMENSIONS mm					BASIC LOAD RATING kN		LIMITING SPEED FOR LUBRICATION min ⁻¹	BEARING DESIGNATION	WEIGHT kg	ADDITIONAL DIMENSIONS													CORROSION-RESISTANT RING
d	D	B	C	rs min	C	C ₀				E _w	b	C1 +0,2	Ca -0,2	K	b1	r	da min	Da max	ra max	rb max	DESIGNATION ACCORDING TO DIN 471		
20	42	30	29	0,3	40	50	3600	NNF5004-PP	0,21	35,5	1,8	24,7	21,0	3,0	4,5	0,5	24,0	38,0	0,3	0,3	42x1,75		
25	47	30	29	0,3	44	60	3000	NNF5005-PP	0,23	40,2	1,8	24,7	21,0	3,0	4,5	0,5	29,0	45,0	0,3	0,3	47x1,75		
30	55	34	33	0,3	52	73	2600	NNF5006-PP	0,35	47,8	2,1	28,2	24,0	3,0	4,5	0,5	34,0	53,0	0,3	0,3	55x2		
35	62	36	35	0,6	66	93	2200	NNF5007-PP	0,45	54,4	2,1	30,2	26,0	3,0	4,5	0,5	39,0	60,0	0,3	0,3	62x2		
40	68	38	37	0,6	81	118	2000	NNF5008-PP	0,53	60,8	2,7	32,2	27,0	3,0	4,5	0,8	44,0	63,0	0,4	0,6	68x2,5		
45	75	40	39	0,6	97	147	1800	NNF5009-PP	0,68	67,5	2,7	34,2	29,0	3,0	4,5	0,8	49,0	70,0	0,4	0,6	75x2,5		
50	80	40	39	0,6	102	161	1700	NNF5010-PP	0,73	72,3	2,7	34,2	29,0	3,0	4,5	0,8	54,0	75,0	0,4	0,6	80x2,5		
55	90	46	45	0,6	120	196	1500	NNF5011-PP	1,1	79,6	3,2	40,2	34,0	3,5	4,5	1,0	60,0	85,0	0,6	0,6	90x3		
60	95	46	45	0,6	125	212	1400	NNF5012-PP	1,2	84,7	3,2	40,2	34,0	3,5	4,5	1,0	65,0	90,0	0,6	0,6	95x3		
65	100	46	45	0,6	130	228	1300	NNF5013-PP	1,3	89,8	3,2	40,2	34,0	3,5	4,5	1,0	70,0	95,0	0,6	0,6	100x3		
70	110	54	53	0,6	171	285	1200	NNF5014-PP	1,9	99,5	4,2	48,2	40,0	3,5	5,0	1,0	75,0	105,0	0,6	0,6	110x4		
75	115	54	53	0,6	178	308	1100	NNF5015-PP	2	105,9	4,2	48,2	40,0	3,5	5,0	1,0	80,0	110,0	0,6	0,6	115x4		
80	125	60	59	0,6	239	426	1000	NNF5016-PP	2,7	113,0	4,2	54,2	46,0	3,5	5,0	1,5	86,0	120,0	1	0,6	125x4		
85	130	60	59	0,6	256	447	1000	NNF5017-PP	2,8	119,4	4,2	54,2	46,0	3,5	5,0	1,5	91,0	125,0	1	0,6	130x4		
90	140	67	66	0,6	292	539	900	NNF5018-PP	3,8	127,1	4,2	59,2	51,0	3,5	5,0	1,5	96,0	135,0	1	0,6	140x4		
95	145	67	66	0,6	297	559	900	NNF5019-PP	4	130,9	4,2	59,2	51,0	3,5	6,0	1,5	101,0	140,0	1	0,6	145x4		
100	150	67	66	0,6	315	578	850	NNF5020-PP	4,1	137,7	4,2	59,2	51,0	3,5	6,0	1,5	106,0	145,0	1	0,6	150x4		
110	170	80	79	0,6	389	711	750	NNF5022-PP	6,5	154,1	4,2	70,2	62,0	3,5	6,0	1,8	117,0	168,0	1	0,6	170x4		
120	180	80	79	0,6	406	765	700	NNF5024-PP	6,9	163,6	4,2	71,2	62,0	3,5	6,0	1,8	127,0	175,0	1	0,6	180x4		
130	190	80	79	0,6	421	820	670	NNF130-PP	7,5	173,202	1,8	71,2	63,0	3,5	6,0	1,8	137	185	1	0,6	190x4		
200	95	94	0,6	582	1062	630	NNF5026-PP	10,5	183,0	4,2	83,2	75,0	4,0	7,0	1,8	157,0	195,0	1	0,6	200x4			
140	200	80	79	0,6	436	875	630	NNF140-PP	8	182,752	1,8	71,2	63,0	4,0	7,0	1,8	147	195	1	0,6	200x4		
210	95	94	0,6	608	1150	600	NNF5028-PP	11	195,1	5,2	83,2	73,0	4,0	7,0	1,8	147,0	205,0	1	0,6	210x5			
150	210	80	79	0,6	457	957	600	NNF150-PP	8,4	197,088	2,1	71,2	61,0	4,0	7,0	1,8	157	205	1	0,6	210x5		
225	100	99	0,6	697	1300	560	NNF5030-PP	13,5	209,0	5,2	83,2	77,0	4,0	7,0	2,0	157,0	220,0	1	0,6	225x5			
160	220	80	79	0,6	471	1010	530	NNF160-PP	8,8	206,641	2,1	71,2	61,0	4,0	7,0	1,8	167	215	1	0,6	220x5		
240	109	108	0,6	727	1410	500	NNF5032-PP	16,5	222,4	5,2	95,2	85,0	4,0	7,0	2,0	167,0	235,0	1	0,6	240x5			
170	230	80	79	0,6	484	1060	500	NNF170-PP	9,3	216,202	2,7	71,2	61,0	4,0	7,0	1,8	177	225	1	0,6	230x5		
260	122	121	0,6	934	1800	480	NNF5034-PP	22,5	238,8	5,2	107,2	97,0	4,0	7,0	2,0	177,0	255,0	1	0,6	260x5			
180	240	80	79	0,6	497	1120	480	NNF180-PP	9,8	225,757	2,7	71,2	61,0	4,0	7,0	1,8	187	235	1	0,6	240x5		
280	136	135	0,6	1110	2180	450	NNF5036-PP	30	258,7	5,2	118,2	108,0	4,0	8,0	2,0	187,0	275,0	1	0,6	280x5			

DOUBLE ROW FULL COMPLEMENT CYLINDRICAL ROLLER BEARINGS ZVL SLOVAKIA, a. s.

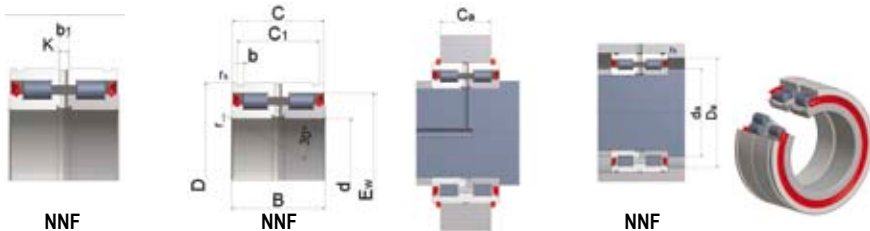

NNF

NNF

NNF

DIMENSIONS mm					BASIC LOAD RATING kN	LIMITING SPEED FOR LUBRICATION min ⁻¹	BEARING DESIGNATION	WEIGHT kg	ADDITIONAL DIMENSIONS											CORRESPONDING SNAP RING
d	D	B	C	rs min					C	Co	Ew	b	C1 +0,2	Ca -0,2	K	b1	r	da min	Da max	
190	260	80	79	0,6	516	1200	450	12,7	240,099	2,7	73,2	63,0	4,0	7,0	1,8	197	255	1	0,6	260x5
	290	136	135	0,6	1130	2270	430	31,5	267,0	5,2	118,2	108,0	4,0	8,0	2,0	197,0	285,0	1	0,6	290x5
200	270	80	79	0,6	528	1260	430	13,2	249,656	3,2	73,2	63,0	4,0	7,0	1,8	207	265	1	0,6	270x5
	310	150	149	0,6	1290	2740	400	42	283,6	6,3	128,2	116,0	4,0	8,0	2,0	207,0	305,0	1	0,6	310x6
220	300	95	94	1	698	1630	400	19,5	276,635	3,2	83,2	73,0	6,0	8,0	2,0	227	294	1	0,6	300x5
	340	160	159	1	1520	3140	360	53,5	308,1	6,3	138,2	126,0	6,0	8,0	2,0	227,0	334,0	1	1	340x6
240	320	95	94	1	732	1780	400	21	299,572	3,2	83,2	71,0	6,0	8,0	2,0	247	314	1	0,6	320x6
	360	160	159	1	1580	3380	340	57,5	327,2	6,3	138,2	126,0	6,0	9,4	2,0	247,0	354,0	1	1	360x6
260	340	95	94	1	833	1080	360	22,5	322,271	4,2	83,2	71,0	6,0	8,0	3,0	289	334	1	0,6	340x6
	400	190	189	1,1	2200	4720	300	84,5	369,7	6,3	162,2	150,0	6,0	9,4	3,0	269,0	393,0	2	2	400x6
280	420	190	189	1,1	2290	5080	270	90	392,6	7,3	163,2	149,0	6,0	9,4	3,0	289,0	413,0	2	2	420x7
300	380	95	94	1	887	2350	320	25,5	358,596	4,2	83,2	71,0	6,0	8,0	3,0	309	374	1	0,6	380x6
	460	218	216	1,1	2880	6210	240	126	417,9	7,3	185,2	171,0	6,0	9,4	3,0	309,0	453,0	2	2	460x7

Note 1) The values in Ca column are valid for assembly with rings according to DIN 417 only

2) Snap rings are not included





DOUBLE ROW SPHERICAL
ROLLER BEARINGS
WITH CYLINDRICAL AND TAPERED BORE

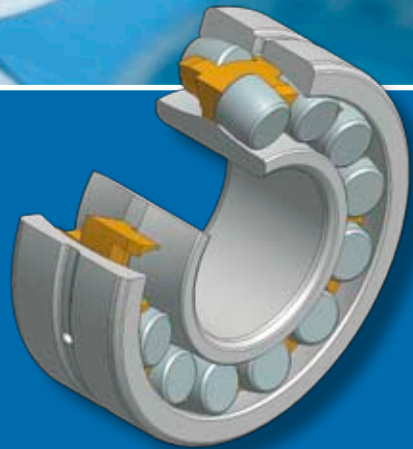

DOUBLE ROW SPHERICAL ROLLER BEARINGS WITH CYLINDRICAL AND TAPERED BORE

The spherical shape of the raceway in the outer ring enables the misalignment of the rings and ensures balanced distribution of load over the rolling elements even under the slightest shaft deflection, or even when the alignment of the bearing beds is not kept.

These unique parameters enable spherical bearings to:

- reach lower operating temperature and higher rotation speed,
- accommodate higher axial load,
- accommodate higher combined load,
- longer operating life.



DESIGN SPECIFICATION

MAIN DIMENSIONS

The main dimensions of double row spherical roller bearings specified in the dimension tables are in accordance with the international standards ISO 15 (STN 02 4629).

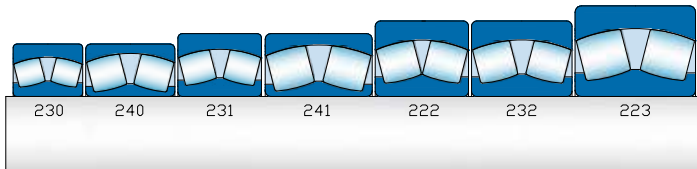

STRUCTURE

The internal structure of the double row spherical roller bearings utilizes symmetric cylindrical rollers and in dependence on the cage design it has a number of modifications. The design with two-part pressed steel cage, with a floating central collar of the inner ring is marked "E...J". The bearing with a one-part brass cage running on the inner ring is marked "M" and two part brass cage is marked "MB".



EW33J

W33M

MB

TOLERANCE

Double-row spherical roller and spherical roller thrust bearings are commonly produced in the basic P0 tolerance class. Production of bearings with a higher tolerance class should be discussed in advance with the manufacturer. The limit values of deviations in tolerances and the operation are specified in ISO 492.

RADIAL CLEARANCE

Commonly produced double-row spherical roller bearings have normal radial clearance which is not indicated. In specific cases bearings with radial clearance C2 (smaller than normal clearance) or with the radial clearance C3, C4, C5 (greater than normal clearance) can be produced.

LUBRICATION GROOVE AND HOLES IN THE OUTER RING

In order to ensure better lubrication and higher reliability of the operation double-row spherical roller bearings have a groove and three lubrication holes (W33) in the outer ring.

BORE OF THE INNER RING

Double row spherical bearings are produced with a cylindrical or a tapered bore (K), taper 1:12 or 1:30. Bearings with tapered bore are mounted directly to a tapered pivot or to a cylindrical pivot using adapter or withdrawal sleeves in accordance with ISO 2982-1,2.

STABILISATION FOR OPERATION AT HIGHER TEMPERATURE

For arrangements with operating temperature higher than 120 °C specially stabilised double row spherical roller bearings with stabilised shape for operating temperature from 150 °C to 400 °C (S0, S1, S2, S3, S4 and S5) that are in accordance with ISO 2982-1,2 are produced. Delivery of stabilised bearings should be discussed in advance with the manufacturer.

MISALIGNMENT

Double-row spherical roller bearings can misalign from the central position without affecting their correct function.

PERMITTED MISALIGNMENT	BEARING TYPE
1°30'	222XX, 230XX, 231XX, 233XX, 239XX
2°	223XX, 240XX
2°30'	232XX, 241XX

AXIAL LOAD RATIO OF BEARINGS MOUNTED WITH ADAPTER SLEEVES

When mounting double row spherical roller bearings to a shaft using adapter sleeves the axial load rating depends on the friction between the shaft and the adapter sleeve. For the properly installed bearings the acceptable axial load can be calculated as follows:

$$F_{ap} = 3Bd$$

F_{ap} - maximum acceptable axial load (N)
 B - width of the bearing
 D - diameter of the bearing bore

RADIAL EQUIVALENT DYNAMIC LOAD

If the bearing is subject to simultaneous radial and axial load, the radial dynamic load is calculated as follows:

$$P_r = F_r + Y_1 F_a \quad \text{for } F_a/F_r \leq e$$

$$P_r = 0,67F_r + Y_2 F_a \quad \text{for } F_a/F_r > e$$

P_r - radial dynamic equivalent load [N]
 F_r - radial load [N]
 F_a - axial load [N]
 e, Y_1, Y_2 - see the table section.

RADIAL EQUIVALENT STATIC LOAD

Radial equivalent static load is calculated as follows:

$$P_{or} = F_r + Y_3 F_a$$

P_{or} - radial static equivalent load [N]
 F_r - radial load of the bearing [N]
 F_a - axial load of the bearing [N]
 Y_3 - see the table section

LIMITING SPEED

The limiting speed specified in the tables section of the catalogue is the maximum number of revolutions acceptable for the bearing to operate trouble-free at a certain level of safety. Following conditions must be fulfilled:

- bearing load corresponds to the service life $L_{10} \approx 100.000$ hours,
- axial forces F_a affecting a radial spherical roller bearing reach max. 25% of the radial force F_r ,
- bearings have been produced at the normal level of tolerance class with normal radial clearance
- limiting speed value for oil lubrication applies to oil-bath lubrication.

DESIGNATION

The designation of basic designs of the bearings is specified in the dimension tables. Modification of the basic design is designated with additional symbols according to STN 02 4608. The meaning of the most used symbols for double-row spherical roller is in the table.

SYMBOL	EXAMPLE	MEANING
K	22208EKW33J	Tapered bore, taper 1:12
W33	22311EW33J	Lubrication groove and holes in the outer ring
J	22215EW33J	Pressed steel cage, rolling element centred
M	22218W33M	Massive brass cage, rolling elements centred
E	22319EW33J	Bearing with higher basic load rating
P6	22214EW33J P6	Higher tolerance class
C2	22309EW33J C2	Radial clearance smaller than normal (normal radial clearance is not indicated)
C4	22326KW33M C4	Radial clearance greater than C3
S2	22308W33M C5S2	Stabilisation of both rings for operating temperature to 250 °C



DOUBLE ROW SPHERICAL ROLLER BEARINGS ZVL SLOVAKIA, a. s.

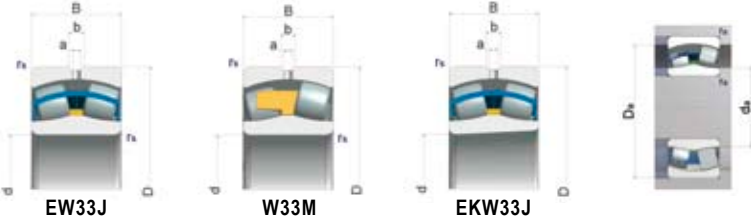

DIMENSIONS mm				BASIC LOAD RATING kN		LIMITING SPEED FOR LUBRICATION min ⁻¹		BEARING DESIGNATION		WEIGHT kg		ACCESSORIES			ABUTMENT AND FILLET DIMENSIONS			COEFFICIENTS			
d	D	B	rs min	Co	Co			CYLINDRICAL BORE	TAPERED BORE (1 : 12)	K	ADAPTER SLEEVE	WITH DRAWAL SLEEVE	WITH DRAWAL NUT	da min	Da max	ra max	e	Y ₁	Y ₂	Y ₃	
25	52	18	1	56,9	61,8	6000	7500	22205EW33J	22205EKW33J	0,18	0,18	H305	AH305	KM6	31	46	1	0,34	1,8	2,9	1,8
40	80	23	1,1	93,1	105	6000	7500	22208EW33J	22208EKW33J	0,51	0,5	H308	AH308	KM9	47	73	1	0,27	2,5	3,7	2,4
	80	23	1,1	82,8	93,1	6000	7500	22208W33M	22208KW33MB	0,51	0,5	H308	AH308	KM9	47	73	1	0,26	2,8	3,6	2,3
	80	23	1,1	82,8	93,1	6000	7500	22208W33MB	22208KW33MB	0,51	0,5	H308	AH308	KM9	47	73	1	0,26	2,8	3,6	2,3
	90	33	1,5	133	149	4100	5100	22308EW33J	22308EKW33J	1,07	1,05	H2308	AH2308	KM9	49	81	1	0,42	1,6	2,4	1,6
45	85	23	1,1	97,3	112,8	5300	6700	22209EW33J	22209EKW33J	0,55	0,53	H309	AH309	KM10	52	78	1	0,26	2,6	3,9	2,6
	85	23	1,1	86,6	100,8	5300	6700	22209W33M	22209W33M	0,55	0,53	H309	AH309	KM10	52	78	1	0,25	2,7	3,8	2,5
	85	23	1,1	86,6	100,8	5300	6700	22209W33MB	22209W33MB	0,55	0,53	H309	AH309	KM10	52	78	1	0,25	2,7	3,8	2,5
	100	36	1,5	159	182	3700	4600	22309EW33J	22309EKW33J	1,43	1,4	H2309	AH2309	KM10	54	91	1	0,42	1,6	2,4	1,6
50	100	36	1,5	153,4	178,5	3700	4600	22309W33M	22309KW33M	1,43	1,4	H2309	AH2309	KM10	54	91	1	0,41	1,5	2,4	1,5
	100	36	1,5	153,4	178,5	3700	4600	22309W33MB	22309KW33MB	1,43	1,4	H2309	AH2309	KM10	54	91	1	0,41	1,5	2,4	1,5
	110	40	2	190	226	3300	4000	22210EW33J	22210EKW33J	1,92	1,88	H2310	AH2310X	KM11	60	100	1,5	0,36	1,9	2,7	1,6
	110	40	2	186,4	220	3300	4000	22210W33M	22210KW33M	1,92	1,88	H2310	AH2310X	KM11	60	100	1,5	0,35	2,1	3	1,9
55	110	40	2	186,4	220	3300	4000	22210W33MB	22210KW33MB	1,92	1,88	H2310	AH2310X	KM11	60	100	1,5	0,35	2,1	3	1,9
	100	25	1,5	124	148	4500	5600	22211EW33J	22211EKW33J	0,78	0,76	H311	AH311X	KM12	64	91	1	0,23	2,9	4,4	2,9
	100	25	1,5	114,6	138,5	4500	5600	22211W33M	22211KW33M	1,78	0,77	H311	AH311X	KM12	64	91	1	0,21	3	4,4	2,9
	100	25	1,5	114,6	138,5	4500	5600	22211W33MB	22211KW33MB	1,78	0,77	H311	AH311X	KM12	64	91	1	0,21	3	4,4	2,9
60	120	43	2,1	230	279	3000	3800	22211EW33J	22211EKW33J	2,4	2,3	H2311	AH2311X	KM12	65	110	2	0,42	1,6	2,4	1,6
	120	43	2,1	222,4	265,8	3000	3800	22211W33M	22211KW33M	2,4	2,3	H2311	AH2311X	KM12	65	110	2	0,41	1,7	2,5	1,6
	110	28	1,5	143	175	40000	5000	22212EW33J	22212EKW33J	1,07	1,05	H312	AH312X	KM13	69	101	1	0,24	2,8	4,2	2,8
	110	28	1,5	130,2	158,2	40000	5000	22212W33M	22212KW33M	1,07	1,05	H312	AH312X	KM13	69	101	1	0,23	2,8	4,2	2,8
65	110	28	1,5	130,2	158,2	40000	5000	22212W33MB	22212KW33MB	1,07	1,05	H312	AH312X	KM13	69	101	1	0,23	2,8	4,2	2,8
	130	46	2,1/4,5	273	315	2800	3600	22312EW33J	22312EKW33J	2,9	2,8	H2312	AH2312X	KM13	72	118	1,5	0,39	1,8	2,8	1,7
	130	46	2,1	212	284	2800	3300	22312W33M	22312KW33M	3	2,9	H2312	AH2312X	KM13	72	118	1,5	0,41	1,6	2,4	1,6
	120	31	1,5	177	216	2600	3400	22213EW33J	22213EKW33J	1,45	1,42	H313	AH313	KM15	74	111	1	0,24	2,89	4,2	2,8
70	120	31	1,5	158,8	199,2	2600	3400	22213W33M	22213KW33M	1,45	1,42	H313	AH313	KM15	74	111	1	0,23	2,7	4,3	2,8
	120	31	1,5	158,8	199,2	2600	3400	22213W33MB	22213KW33MB	1,45	1,42	H313	AH313	KM15	74	111	1	0,23	2,7	4,3	2,8
	140	48	2,1	304	351	2600	3400	22313EW33J	22313EKW33J	3,5	3,4	H2313	AH2313	KM15	77	128	1,5	0,24	2,8	4,1	2,7
	140	48	2,1	253	300	2700	3200	22313W33M	22313KW33M	3,6	3,5	H2313	AH2313	KM15	77	128	1,5	0,38	1,8	2,5	1,7
75	125	31	1,5	189	239	3600	4500	22214EW33J	22214EKW33J	1,61	1,57	H314	AH314	KM16	79	116	1	0,24	2,8	4,2	2,8
	125	31	1,5	158,1	201	3600	4500	22214W33M	22214KW33M	1,61	1,57	H314	AH314	KM16	79	116	1	0,22	2,9	4,1	2,7
	125	31	1,5	158,1	201	3600	4500	22214W33MB	22214KW33MB	1,61	1,57	H314	AH314	KM16	79	116	1	0,22	2,9	4,1	2,7
	150	51	2,1	344	402	2400	3100	22314EW33J	22314EKW33J	4,2	4,1	H2314	AH2314X	KM16	82	138	1,5	0,31	2,5	3,2	2,4
75	150	51	2,1	319,8	391,4	2400	3100	22314W33M	22314KW33M	4,2	4,1	H2314	AH2314X	KM16	82	138	1,5	0,37	1,8	2,7	1,8
	150	51	2,1	319,8	391,4	2400	3100	22314W33MB	22314KW33MB	4,2	4,1	H2314	AH2314X	KM16	82	138	1,5	0,37	1,8	2,7	1,8
	130	31	1,5	196	255	3400	4300	22215EW33J	22215EKW33J	1,7	1,66	H315	AH315	KM17	84	121	1	0,24	2,8	4,2	2,8
	130	31	1,5	164,2	208,8	3400	4300	22215W33M	22215KW33M	1,7	1,66	H315	AH315	KM17	84	121	1	0,23	3	4,4	2,9
75	130	31	1,5	164,2	208,8	3400	4300	22215W33MB	22215KW33MB	1,7	1,66	H315	AH315	KM17	84	121	1	0,23	3	4,4	2,9
	160	55	2,1	396	489	2300	3000	22315EW33J	22315EKW33J	5,3	5,2	H2315	AH2315X	KM17	87	148	1,5	0,31	2,5	3,2	2,4
	160	55	2,1	365,4	451,8	2300	3000	22315W33M	22315KW33M	5,3	5,2	H2315	AH2315X	KM17	87	148	1,5	0,38	1,8	2,6	1,7
	160	55	2,1	365,4	451,8	2300	3000	22315W33MB	22315KW33MB	5,3	5,2	H2315	AH2315X	KM17	87	148	1,5	0,38	1,8	2,6	1,7

DOUBLE ROW SPHERICAL ROLLER BEARINGS ZVL SLOVAKIA, a. s.

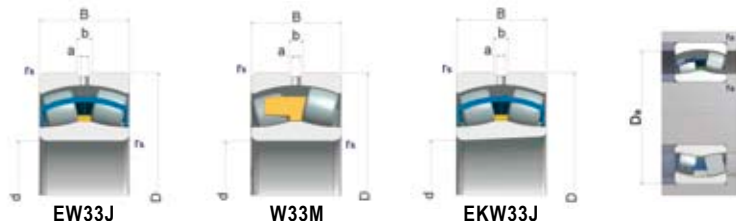

DIMENSIONS mm	BASIC LOAD RATING kN	LIMITING SPEED FOR LUBRICATION min ⁻¹	BEARING DESIGNATION		WEIGHT kg	ACCESSORIES			ABUTMENT AND FILLET DIMENSIONS			COEFFICIENTS		
			CYLINDRICAL BORE	TAPERED BORE (1 : 12)		K	ADAPTER SLEEVE	WITH DRAWAL SLEEVE	WITH DRAWAL NUT	da min	Da max	ra max	e	Y ₁
80	140 33 2	224 295 3200	4000	22216EW33J	22216EKW33J	2,11 2,07	H316	AH316	KM18	90 130 1,5 0,26 2,6 3,9 2,6				
	140 33 2	189,5 250,4 3200	4000	22216W33M	22216KW33M	2,11 2,07	H316	AH316	KM18	90 130 1,5 0,24 3,1 4 2,9				
	170 58 2,1	397,3 496,8 2200	2800	22316EW33J	22316EKW33J	6,3 6,1	H2316	AH2316X	KM18	92 158 1,5 0,31 2,5 3,2 2,4				
	170 58 2,1	397,3 496,8 2200	2800	22316W33M	22316KW33M	6,3 6,1	H2316	AH2316X	KM18	92 158 1,5 0,37 1,8 2,7 1,8				
	170 58 2,1	397,3 496,8 2200	2800	22316W33MB	22316KW33MB	6,3 6,1	H2316	AH2316X	KM18	92 158 1,5 0,37 1,8 2,7 1,8				
85	150 36 2	260 337 3000	3800	22217EW33J	22217EKW33J	2,61 2,6	H317	AH317X	KM19	95 140 1,5 0,26 2,6 3,9 2,6				
	150 36 2	252,1 343,7 3000	3800	22217W33M	22217KW33M	2,61 2,6	H317	AH317X	KM19	95 140 1,5 0,24 2,8 4 2,7				
	150 36 2	252,1 343,7 3000	3800	22217W33MB	22217KW33MB	2,61 2,6	H317	AH317X	KM19	95 140 1,5 0,24 2,8 4 2,7				
	180 60 3	482 603 2000	2600	22317EW33J	22317EKW33J	7,2 7	H2317	AH2317X	KM19	99 166 2,5 0,31 2,5 3,2 2,4				
	180 60 3	430,5 543,8 2000	2600	22317W33M	22317KW33M	7,2 7	H2317	AH2317X	KM19	99 166 2,5 0,37 1,9 2,8 1,8				
90	160 40 2	308 406 2600	3400	22218EW33J	22218EKW33J	3,4 3,4	H318	AH318X	KM20	100 150 1,5 0,26 2,6 3,8 2,5				
	160 40 2	215 289 2000	2500	22218W33M	22218KW33M	3,6 3,4	H318	AH318X	KM20	100 150 1,5 0,24 2,8 3,9 2,5				
	160 40 2	215 289 2000	2500	22218W33MB	22218KW33MB	3,6 3,4	H318	AH318X	KM20	100 150 1,5 0,24 2,8 3,9 2,5				
	160 52,4 2	316 453 1900	2400	23218W33M	23218KW33M	4,7 4,6	H2318	AH3218X	KM20	100 150 1,5 0,33 2 3 1,9				
	190 64 3	536 673 1900	2400	22318EW33J	22318EKW33J	8,5 8,3	H2318	AH3218X	KM20	104 176 2,5 0,31 2,5 3,2 2,4				
95	170 43 2,1	346 464 2400	3200	22219EW33J	22219EKW33J	4,17 4,1	H319	AH319X	KM21	107 158 1,5 0,27 2,5 3,7 2,5				
	170 43 2,1	319,2 431,8 2400	3200	22219W33M	22219KW33M	4,17 4,1	H319	AH319X	KM21	107 158 1,5 0,25 2,8 3,9 2,7				
	170 43 2,1	319,2 431,8 2400	3200	22219W33MB	22219KW33MB	4,17 4,1	H319	AH319X	KM21	107 158 1,5 0,25 2,8 3,9 2,7				
	200 67 3	587 744 1800	2300	22319EW33J	22319EKW33J	9,8 9,6	H2319	AH2319	KM21	109 186 2,5 0,31 2,5 3,2 2,4				
	200 67 3	531,2 695,6 1800	2300	22319W33M	22319KW33M	9,8 9,6	H2320	AH2320	KM22	109 186 2,5 0,37 1,8 2,7 1,8				
100	180 46 2,1	379 510 2200	3000	22220EW33J	22220EKW33J	5 4,9	H320	AH320X	KM22	112 168 1,5 0,27 2,5 3,7 2,4				
	180 46 2,1	311 415 1900	2400	22220W33M	22220KW33M	5,3 5,2	H320	AH320X	KM22	112 168 1,5 0,26 2,7 3,9 2,7				
	180 46 2,1	311 415 1900	2400	22220W33MB	22220KW33MB	5,3 5,2	H320	AH320X	KM22	112 168 1,5 0,26 2,7 3,9 2,7				
	180 60,3 2,1	443,2 648,2 1700	2400	23220EW33J	23220EKW33J	6,9 6,7	H2320	AH3220X	KM22	112 168 1,5 0,27 2,1 3 2				
	180 60,3 2,1	400 570 1700	2000	23220W33M	23220KW33M	6,9 6,7	H2320	AH3220X	KM22	112 168 1,5 0,34 2 2,8 1,9				
110	215 73 3	682 842 1700	2200	22320EW33J	22320EKW33J	12,3 12,1	H2320	AH3220X	KM22	114 201 2,5 0,31 2,5 3,2 2,4				
	215 73 3	546 815 1700	2000	22320W33M	22320KW33M	13 12,7	H2320	AH3220X	KM22	114 201 2,5 0,37 1,8 2,6 1,7				
	215 73 3	546 815 1700	2000	22320W33MB	22320KW33MB	13 12,7	H2320	AH3220X	KM22	114 201 2,5 0,37 1,8 2,6 1,7				
	170 45 2	308,4 496,5 2200	3000	23022EW33J	23022EKW33J	3,75 3,72	H3022	AH3022	KM24	120 160 1,5 0,23 2,9 4,3 2,8				
	170 60 2	387,5 666,9 1800	2200	24022EW33J	24022EKW33J	5,05 4,96	-	-	-	120 160 1,5 0,32 2,1 3,2 2,1				
	180 56 3	374 588 1900	2800	23122EW33J	23122EKW33J	6 5,3	H3122	AH122X	KM24	120 170 2 0,28 2,1 3,3 2				
	180 56 3	407 644,1 1900	2600	23122W33M	23122KW33M	6 5,3	H3122	AH122X	KM24	120 170 2 0,3 2,3 3,4 2,2				
	180 69 2	469,5 769,2 1000	1400	24122EW33J	24122EKW33J	6,94 6,83	-	AH24122	KM23	120 170 2 0,35 1,9 2,8 1,9				
	200 53 2,1	488 652 2000	2800	22222EW33J	22222EKW33J	7,2 6,94	H322	AH3122X	KM24	122 188 2 28 2,4 3,6 2,4				
	200 53 2,1	426,5 593,1 2000	2800	22222W33M	22222KW33M	7,2 6,94	H322	AH3122X	KM24	122 188 2 28 2,4 3,6 2,4				
	200 53 2,1	426,5 593,1 2000	2800	22222W33MB	22222KW33MB	7,2 6,94	H322	AH3122X	KM24	122 188 2 28 2,4 3,6 2,4				
200 69,8 2,1	551 830,7 1500	1800	23222EW33J	23222EKW33J	9,65 9,4	H2322	AH3222X	KM25	122 188 2 0,27 2,1 3 2					
200 69,8 2,1	528 786 1500	1800	23222W33M	23222KW33M	9,9 9,6	H2322	AH3222X	KM25	122 188 2 0,36 1,9 2,7 1,8					
200 69,8 2,1	528 786 1500	1800	23222W33MB	23222KW33MB	9,9 9,6	H2322	AH3222X	KM25	122 188 2 0,36 1,9 2,7 1,8					
240 80 3	805 1000 1500	1900	22322EW33J	22322EKW33J	17,2 16,8	H2322	AH3222X	KM25	124 226 2,5 0,37 1,8 2,7 1,8					
240 80 3	653 955 1500	1800	22322W33M	22322KW33M	18,2 17,9	H2322	AH3222X	KM25	124 226 2,5 0,36 1,8 2,6 1,7					
240 80 3	653 955 1500	1800	22322W33MB	22322KW33MB	18,2 17,9	H2322	AH3222X	KM25	124 226 2,5 0,36 1,8 2,6 1,7					



DOUBLE ROW SPHERICAL ROLLER BEARINGS ZVL SLOVAKIA, a. s.

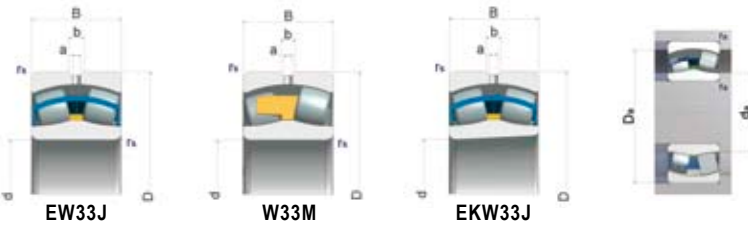

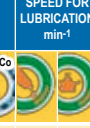
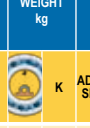
DIMENSIONS mm			BASIC LOAD RATING kN		LIMITING SPEED FOR LUBRICATION min ⁻¹		BEARING DESIGNATION		WEIGHT kg		ACCESSORIES			ABUTMENT AND FILLET DIMENSIONS			COEFFICIENTS				
d	D	B	rs min	C	Co					K	ADAPTER SLEEVE	WITH DRAWAL SLEEVE	WITH DRAWAL NUT	da min	Da max	ra max	e	Y ₁	Y ₂	Y ₃	
120	180	46	2	301	500	1600	1900	23024EW33J	23024EKW33J	3,9	3,8	H3024	AH3024X	KM26	130	170	2	0,24	2,7	3,9	2,6
	180	46	2	320,1	532,7	1600	1900	23024W33M	23024KW33M	4	3,9	H3024	AH3024X	KM26	130	170	2	0,25	2,8	4	2,6
	180	60	2	395,4	700,1	1600	2000	24024EW33J	24024EKW33J	5,35	5,26	-	AH24024	KM25	130	170	2	0,3	2,3	3,4	2,2
	200	62	2	487,7	762,8	1800	2400	23124EW33J	23124EKW33J	7,89	7,8	H3124	AH3124X	KM26	130	190	2	0,28	2,8	3,3	2,5
	200	62	2	431	646	1500	1800	23124W33M	23124KW33M	8,2	8	H3124	AH3124X	KM26	130	190	2	0,31	2,1	3,1	2
	200	80	2	604,2	1008,1	1950	1300	24124EW33J	24124EKW33J	10,1	9,9	-	AH24124	KM26	130	190	2	0,37	1,8	2,7	1,8
	215	58	2,1	525	749	1900	2600	22224EW33J	22224EKW33J	9	8,8	H3124	AH3124X	KM26	132	203	2	0,25	2,7	3,9	2,5
	215	58	2,1	516,2	733	1900	2600	22224W33M	22224KW33M	9,4	9,2	H3124	AH3124X	KM26	132	203	2	0,25	2,7	3,9	2,5
	215	58	2,1	516,2	733	1900	2600	22224W33MB	22224KW33MB	9,4	9,2	H3124	AH3124X	KM26	132	203	2	0,25	2,7	3,9	2,5
	215	76	2,1	641,1	987,8	1500	1900	23224EW33J	23224EKW33J	11,7	11,4	H2324	AH3224X	KM27	132	203	2	0,33	2	3	2
	215	76	2,1	621,2	958,9	1500	1900	23224W33M	23224KW33M	12,1	11,9	H2324	AH3224X	KM27	132	203	2	0,27	2,1	3	2
	215	76	2,1	621,2	958,9	1500	1900	23224W33MB	23224KW33MB	12,1	11,9	H2324	AH3224X	KM27	132	203	2	0,27	2,1	3	2
	260	86	3	922	1165	1400	1800	22324EW33J	22324EKW33J	21,5	21,1	H2324	AH2324X	KM27	134	246	2,5	0,33	2,1	3,1	2
	260	86	3	766	1100	1400	1700	22324W33M	22324KW33M	22,1	21,6	H2324	AH2324X	KM27	134	246	2,5	0,36	1,9	2,7	1,8
260	86	3	766	1100	1400	1700	22324W33MB	22324KW33MB	22,1	21,6	H2324	AH2324X	KM27	134	246	2,5	0,36	1,9	2,7	1,8	
130	200	52	2	361	571	1500	1800	23026EW33J	23026EKW33J	5,7	5,6	H3026	AH3026X	KM28	140	190	2	0,26	2,6	3,8	2,5
	200	52	2	412,4	682,3	1500	1800	23026W33M	23026KW33M	5,7	5,6	H3027	AH3026X	KM29	140	190	2	0,24	2,8	3,9	2,7
	200	52	2	412,4	682,3	1500	1800	23026W33MB	23026KW33MB	5,7	5,6	H3027	AH3026X	KM29	140	190	2	0,24	2,8	3,9	2,7
	200	69	2	488,9	850,3	1500	1900	24026EW33J	24026EKW33J	7,95	7,81	-	AH24026	KM27	140	190	2	0,31	2,2	3,2	2,1
	210	64	2	517	839,3	1700	2200	23126EW33J	23126EKW33J	9,1	8,8	H3126	AH24026	KM27	140	200	2	0,28	2,6	3,3	2,5
	210	64	2	474	752	1400	1700	23126W33M	23126KW33M	8	7,9	H3126	AH24026	KM27	140	200	2	0,31	2,2	3,1	2
	210	64	2	474	752	1400	1700	23126W33MB	23126KW33MB	8	7,9	H3126	AH24026	KM27	140	200	2	0,31	2,2	3,1	2
	210	80	2	649,6	1130,5	1900	1200	24126EW33J	24126EKW33J	10,8	10,6	H3126	AH24026	KM27	140	200	2	0,31	2,2	3,1	2
	230	64	3	709	1040	1800	2400	22226EW33J	22226EKW33J	11,2	11	H3126	AH3126X	KM28	144	216	2,5	0,26	2,6	3,8	2,5
	230	64	3	546	800	1500	1800	22226W33M	22226KW33M	11,8	11,7	H3126	AH3126X	KM28	144	216	2,5	0,29	2,3	3,3	2,2
	230	64	3	546	800	1500	1800	22226W33MB	22226KW33MB	11,8	11,7	H3126	AH3126X	KM28	144	216	2,5	0,29	2,3	3,3	2,2
	280	93	4	1091	1379	1300	1700	23226EW33J	23226EKW33J	13,95	13,6	H3226	AH3236X	KM29	144	216	2,5	0,33	2,1	3,1	2
	280	93	4	648,9	982,4	1300	1700	23226W33M	23226KW33M	15,2	14,9	H2326	AH2326X	KM29	144	216	2,5	0,27	2,1	3	2
	280	93	4	648,9	982,4	1300	1700	23226W33MB	23226KW33MB	15,2	14,9	H2326	AH2326X	KM29	144	216	2,5	0,27	2,1	3	2
280	93	4	1124	1518	1300	1700	23232EW33J	23232EKW33J	26,8	26,2	H3226	AH3236X	KM29	148	262	3	0,33	2,1	3,1	2	
280	93	4	978	1320	1300	1600	23232W33M	23232KW33M	28,6	28	H2326	AH2326X	KM29	148	262	3	0,36	1,8	2,7	1,8	
280	93	4	978	1320	1300	1600	23232W33MB	23232KW33MB	28,6	28	H2326	AH2326X	KM29	148	262	3	0,36	1,8	2,7	1,8	
140	210	53	2	380	634	1400	1700	23028EW33J	23028EKW33J	6,9	6,7	H3028	AH3028X	KM30	150	200	2	0,24	2,7	3,9	2,6
	210	53	2	421	714,3	1400	1700	23028W33M	23028KW33M	6,9	6,7	H3028	AH3028X	KM30	150	200	2	0,26	2,9	3,9	2,8
	210	53	2	421	714,3	1400	1700	23028W33MB	23028KW33MB	6,9	6,7	H3028	AH3028X	KM30	150	200	2	0,26	2,9	3,9	2,8
	210	69	2	534,2	973,3	1400	1800	24028EW33J	24028EKW33J	8,52	8,4	-	AH24028	KM29	150	200	2	0,29	2,3	3,4	2,3
	210	69	2	458,2	847,9	1400	1800	24028W33M	24028KW33M	8,7	8,6	-	AH24028	KM29	150	200	2	0,29	2,3	3,4	2,3
	225	68	2,1	592,6	957,1	1300	1600	23128EW33J	23128EKW33J	10,6	10,4	H3128	AH3128X	KM30	152	213	2	0,3	2,2	3,2	2,1
	225	68	2,1	540	866	1300	1600	23128W33M	23128KW33M	10,8	10,5	H3128	AH3128X	KM30	152	213	2	0,32	2,1	2,9	2,1
	225	68	2,1	540	866	1300	1600	23128W33MB	23128KW33MB	10,8	10,5	H3128	AH3128X	KM30	152	213	2	0,32	2,1	2,9	2,1
	225	85	2,1	706	1240,2	850	1100	24128EW33J	24128EKW33J	13,1	12,9	-	AH24128	KM30	152	213	2	0,35	1,9	2,9	1,9
	225	85	2,1	619,7	1087,8	850	1100	24128W33M	24128KW33M	13,4	13,2	-	AH24128	KM30	152	213	2	0,35	1,9	2,9	1,9
	250	68	3	793	1170	1700	2200	22228EW33J	22228EKW33J	14,1	13,8	H3128	AH3128X	KM30	154	236	2,5	0,25	2,7	3,9	2,5
	250	68	3	610	900	1400	1700	22228W33M	22228KW33M	15	14,6	H3128	AH3128X	KM30	154	236	2,5	0,28	2,4	3,4	2,2
	250	68	3	610	900	1400	1700	22228W33MB	22228KW33MB	15	14,6	H3128	AH3128X	KM30	154	236	2,5	0,28	2,4	3,4	2,2
	250	88	3	856,3	1347,5	1200	1500	23228EW33J	23228EKW33J	18,9	18,3	H2328	AH3228X	KM31	154	236	2,5	0,36	1,9	2,7	1,8
250	88	3	910	1365	1200	1500	23228W33M	23228KW33M	19,2	18,6	H2328	AH3228X	KM31	154	236	2,5	0,27	2,1	3	2	
250	88	3	910	1365	1200	1500	23228W33MB	23228KW33MB	19,2	18,6	H2328	AH3228X	KM31	154	236	2,5	0,27	2,1	3	2	

DOUBLE ROW SPHERICAL ROLLER BEARINGS ZVL SLOVAKIA, a. s.

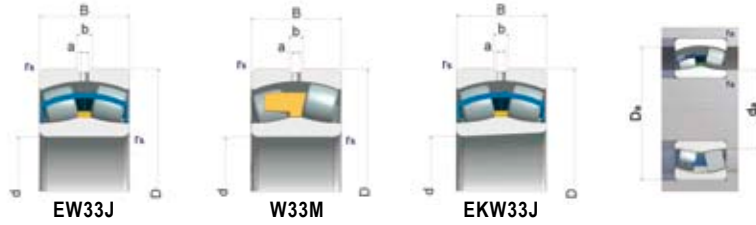

DIMENSIONS mm	BASIC LOAD RATING kN			LIMITING SPEED FOR LUBRICATION min ⁻¹	BEARING DESIGNATION		WEIGHT kg	ACCESSORIES			ABUTMENT AND FILLET DIMENSIONS			COEFFICIENTS							
	d	D	B		CYLINDRICAL BORE	TAPERED BORE (1 : 12)		K	ADAPTER SLEEVE	WITH DRAWAL SLEEVE	WITH DRAWAL NUT	da min	Da max	ra max	e	Y ₁	Y ₂	Y ₃			
140	300	102	4	1127,9	1571,3	1200	1500	22328EW33J	22328EKW33J	33,4	32,7	H2328	AH2328X	KM31	158	282	3	0,33	2,1	3,1	2
	300	102	4	1210	1950	1200	1500	22328W33M	22328KW33M	35,6	34,8	H2328	AH2328X	KM31	158	282	3	0,38	1,8	2,5	1,7
	300	102	4	1210	1950	1200	1500	22328W33MB	22328KW33MB	35,6	34,8	H2328	AH2328X	KM31	158	282	3	0,38	1,8	2,5	1,7
150	225	56	2,1	463,4	794,1	1300	1600	23030EW33J	23030EKW33J	7,8	7,55	H3030	AH3030X	KM32	162	213	2	0,24	2,7	3,9	2,6
	225	56	2,1	435	855	1300	1600	23030W33M	23030KW33M	8,3	8	H3030	AH3030X	KM32	162	213	2	0,28	2,6	4	2,6
	225	56	2,1	435	855	1300	1600	23030W33MB	23030KW33MB	8,3	8	H3030	AH3030X	KM32	162	213	2	0,28	2,6	4	2,6
	225	75	2,1	605,7	1124,1	1300	1700	24030EW33J	24030EKW33J	10,7	10,5	-	AH24030	KM31	162	213	2	0,3	2,3	3,4	2,2
	225	75	2,1	597,8	1105,4	1300	1700	24030W33M	24030KW33M	11,2	10,9	-	AH24030	KM31	162	213	2	0,3	2,3	3,4	2,2
	225	75	2,1	597,8	1105,4	1300	1700	24030W33MB	24030KW33MB	11,2	10,9	-	AH24030	KM31	162	213	2	0,3	2,3	3,4	2,2
	250	80	2,1	764,6	1285,8	1200	1500	23130EW33J	23130EKW33J	16,75	16,2	H3130	AH3130X	KM33	162	238	2	0,3	2,3	3,1	2,1
	250	80	2,1	711	1129	1200	1500	23130W33M	23130KW33M	16,6	16,1	H3130	AH3130X	KM33	162	238	2	0,32	2,1	3	2
	250	80	2,1	711	1129	1200	1500	23130W33MB	23130KW33MB	16,6	16,1	H3130	AH3130X	KM33	162	238	2	0,32	2,1	3	2
	250	100	2,1	975	1670	800	1000	24130EW33J	24130EKW33J	19,9	19,6	-	AH24130	KM32	162	238	2	0,37	1,8	2,7	1,8
	250	100	2,1	767,8	1260,2	800	1000	24130W33M	24130KW33M	20,2	19,9	-	AH24130	KM32	162	238	2	0,37	1,8	2,7	1,8
	250	100	2,1	767,8	1260,2	800	1000	24130W33MB	24130KW33MB	20,2	19,9	-	AH24130	KM32	162	238	2	0,37	1,8	2,7	1,8
	270	73	3	956	1404	1600	2000	22230EW33J	22230EKW33J	17,9	17,5	H3130	AH3130X	KM33	164	256	2,5	0,25	2,7	3,9	2,5
	270	73	3	736	1080	1300	1600	22230W33M	22230KW33M	18,6	18,2	H3130	AH3130X	KM33	164	256	2,5	0,28	2,3	3,4	2,2
	270	73	3	736	1080	1300	1600	22230W33MB	22230KW33MB	18,6	18,2	H3130	AH3130X	KM33	164	256	2,5	0,28	2,3	3,4	2,2
	270	96	3	973,6	1528,7	1100	1400	23230EW33J	23230EKW33J	23,3	22,6	H2330	AH2320X	KM33	164	256	2,5	0,36	1,8	2,7	1,8
	270	96	3	993,7	1591	1100	1400	23230W33M	23230KW33M	24,6	24	H2330	AH2320X	KM33	164	256	2,5	0,36	1,8	2,7	1,8
270	96	3	993,7	1591	1100	1400	23230W33MB	23230KW33MB	24,6	24	H2330	AH2320X	KM33	164	256	2,5	0,36	1,8	2,7	1,8	
320	109	4	1867,1	1320,4	1100	1400	22330EW33J	22330EKW33J	41,2	40,7	H2330	AH2330X	KM33	168	302	3	0,33	2,1	3,1	2	
320	108	4	1150	1850	1100	1400	22330W33M	22330KW33M	42,5	41,7	H2330	AH2330X	KM33	168	302	3	0,38	1,8	2,6	1,7	
320	108	4	1150	1850	1100	1400	22330W33MB	22330KW33MB	42,5	41,7	H2330	AH2330X	KM33	168	302	3	0,38	1,8	2,6	1,7	
160	240	60	2,1	541,7	938,8	1200	1500	23032EW33J	23032EKW33J	9,5	9,2	H3032	AH3032	KM34	172	228	2	0,24	2,8	4	2,6
	240	60	2,1	486	940	1200	1500	23032W33M	23032KW33M	10,3	10	H3032	AH3032	KM34	172	228	2	0,33	2,3	3,8	2,3
	240	60	2,1	486	940	1200	1500	23032W33MB	23032KW33MB	10,3	10	H3032	AH3032	KM34	172	228	2	0,33	2,3	3,8	2,3
	240	80	2,1	683,6	1270,1	1100	1500	24032EW33J	24032EKW33J	12,9	12,7	-	AH24032	KM34	172	228	2	0,3	2,3	3,4	2,2
	240	80	2,1	683,6	1270,1	1100	1500	24032W33M	24032KW33M	13,1	12,9	-	AH24032	KM34	172	228	2	0,3	2,3	3,4	2,2
	240	80	2,1	683,6	1270,1	1100	1500	24032W33MB	24032KW33MB	13,1	12,9	-	AH24032	KM34	172	228	2	0,3	2,3	3,4	2,2
	270	86	2,1	893	1482,4	1100	1400	23132EW33J	23132EKW33J	20,8	20,2	H3132	AH3132	KM36	172	258	2	0,28	2,8	3,2	2,5
	270	86	2,1	785	1241	1100	1400	23132W33M	23132KW33M	21,3	20,7	H3132	AH3132	KM36	172	258	2	0,32	2,1	3	2
	270	86	2,1	785	1241	1100	1400	23132W33MB	23132KW33MB	21,3	20,7	H3132	AH3132	KM36	172	258	2	0,32	2,1	3	2
	270	109	2,1	1098,6	1865,6	1600	1900	24132EW33J	24132EKW33J	25,7	25,3	-	AH24132	KM34	172	258	2	0,38	1,8	2,7	1,8
	270	109	2,1	998,5	1670,5	1600	1900	24132W33M	24132KW33M	16,3	15,9	-	AH24132	KM34	172	258	2	0,38	1,8	2,7	1,8
	270	109	2,1	998,5	1670,5	1600	1900	24132W33MB	24132KW33MB	16,3	15,9	-	AH24132	KM34	172	258	2	0,38	1,8	2,7	1,8
	290	80	3	1000	1365	1500	1900	22232EW33J	22232EKW33J	22,7	22,2	H3132	AH3132	KM36	174	276	2,5	0,26	2,6	3,8	2,5
	290	80	3	863	1290	1200	1500	22232W33M	22232KW33M	24,4	23,9	H3132	AH3132	KM36	174	276	2,5	0,29	2,3	3,3	2,2
	290	80	3	863	1290	1200	1500	22232W33MB	22232KW33MB	24,4	23,9	H3132	AH3132	KM36	174	276	2,5	0,29	2,3	3,3	2,2
	290	104	3	1163,6	1905,4	1000	1400	23232EW33J	23232EKW33J	30,3	29,4	H2332	AH2322	KM36	174	276	2,5	0,36	1,9	2,8	1,8
	290	104	3	1151,2	1856,7	1000	1400	23232W33M	23232KW33M	31,5	30,6	H2332	AH2322	KM36	174	276	2,5	0,36	1,9	2,8	1,8
290	104	3	1151,2	1856,7	1000	1400	23232W33MB	23232KW33MB	31,5	30,6	H2332	AH2322	KM36	174	276	2,5	0,36	1,9	2,8	1,8	
340	114	4	1476,1	2090,3	1000	1300	22332EW33J	22332EKW33J	49,5	48,5	H2332	AH2332	KM36	178	322	3	0,33	2,1	3,1	2	
340	114	4	1250	1680	1000	1300	22332W33M	22332KW33M	51,9	50,7	H2332	AH2332	KM36	178	322	3	0,37	1,8	2,6	1,7	
340	114	4	1250	1680	1000	1300	22332W33MB	22332KW33MB	51,9	50,7	H2332	AH2332	KM36	178	322	3	0,37	1,8	2,6	1,7	



DOUBLE ROW SPHERICAL ROLLER BEARINGS ZVL SLOVAKIA, a. s.

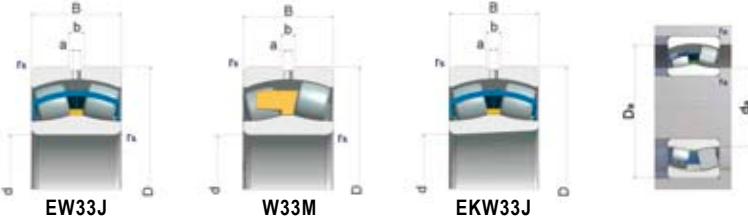

DIMENSIONS mm			BASIC LOAD RATING kN	LIMITING SPEED FOR LUBRICATION min ⁻¹	BEARING DESIGNATION		WEIGHT kg	ACCESSORIES			ABUTMENT AND FILLER DIMENSIONS			COEFFICIENTS							
d	D	B	rs min	Co	CYLINDRICAL BORE	TAPERED BORE (1 : 12)	K	ADAPTER SLEEVE	WITH DRAWAL SLEEVE	WITH DRAWAL NUT	da min	Da max	ra max	e	Y ₁	Y ₂	Y ₃				
170	260	67	2,1	707,9	1229,7	1100	1400	23034EW33J	23034EKW33J	12,6	12,3	H3034	AH3034	KM36	182	248	2	0,25	2,7	3,9	2,6
	260	67	2,1	621	1060	1100	1400	23034W33M	23034KW33M	13,8	13,4	H3034	AH3034	KM36	182	248	2	0,28	2,5	3,7	2,4
	260	90	2,1	784,9	1451	1000	1400	24034EW33J	24034EKW33J	17,3	17,1	-	AH24034	KM36	182	248	2	0,31	2,2	3,2	2,1
	260	90	2,1	784,9	1451	1000	1400	24034W33M	24034KW33M	18	17,8	-	AH24034	KM36	182	248	2	0,31	2,2	3,2	2,1
	260	90	2,1	784,9	1451	1000	1400	24034W33MB	24034KW33MB	18	17,8	-	AH24034	KM36	182	248	2	0,31	2,2	3,2	2,1
	280	88	2,1	930,4	1582,1	1000	1300	23134EW33J	23134EKW33J	21,9	21,3	H3134	AH3134	KM38	182	268	2	0,28	2,7	4,1	2,6
	280	88	2,1	826	1351	1000	1300	23134W33M	23134KW33M	22,8	22,2	H3134	AH3134	KM38	182	268	2	0,31	2,1	3,1	2
	280	88	2,1	826	1351	1000	1300	23134W33MB	23134KW33MB	22,8	22,2	H3134	AH3134	KM38	182	268	2	0,31	2,1	3,1	2
	280	109	2,1	1118,1	1984,7	670	850	24134EW33J	24134EKW33J	27	26,6	-	AH24134	KM36	182	268	2	0,36	1,9	2,8	1,8
	280	109	2,1	1061,2	1881,7	670	850	24134W33M	24134KW33M	28,2	27,8	-	AH24134	KM36	182	268	2	0,36	1,9	2,8	1,8
	280	109	2,1	1061,2	1881,7	670	850	24134W33MB	24134KW33MB	28,2	27,8	-	AH24134	KM36	182	268	2	0,36	1,9	2,8	1,8
	310	86	4	1045,9	1588,1	1100	1400	22234EW33J	22234EKW33J	29,1	28,5	H3134	AH3134	KM38	188	292	3	0,29	2,3	3,3	2,1
	310	86	4	921	1311	1100	1400	22234W33M	22234KW33M	30	29,4	H3134	AH3134	KM38	188	292	3	0,29	2,3	3,3	2,1
	310	86	4	921	1311	1100	1400	22234W33MB	22234KW33MB	30	29,4	H3134	AH3134	KM38	188	292	3	0,29	2,3	3,3	2,1
	310	110	4	1262,9	2066,9	950	1300	23234EW33J	23234EKW33J	35,3	34,3	H2334	AH2334	KM38	188	292	3	0,34	2	3	2
	310	110	4	1230,9	1939,1	950	1300	23234W33M	23234KW33M	37,7	36,7	H2334	AH2334	KM38	188	292	3	0,34	2	3	2
	310	110	4	1230,9	1939,1	950	1300	23234W33MB	23234KW33MB	37,7	36,7	H2334	AH2334	KM38	188	292	3	0,34	2	3	2
360	120	4	1621,8	2298,2	940	1200	22334EW33J	22334EKW33J	57,9	57	H2334	AH2334	KM38	188	342	3	0,33	2,1	3,1	2	
360	120	4	1400	1970	940	1200	22334W33M	22334KW33M	59,2	58,2	H2334	AH2334	KM38	188	342	3	0,37	1,8	2,6	1,7	
360	120	4	1400	1970	940	1200	22334W33MB	22334KW33MB	59,2	58,2	H2334	AH2334	KM38	188	342	3	0,37	1,8	2,6	1,7	
180	280	74	2,1	763,4	1363,6	1000	1300	23036EW33J	23036EKW33J	16,8	16,3	H3036	AH3036	KM38	192	268	2	0,26	2,6	3,7	2,5
	280	74	2,1	725	1250	1000	1300	23036W33M	23036KW33M	17,6	17,1	H3036	AH3036	KM38	192	268	2	0,26	2,7	3,7	2,5
	280	74	2,1	725	1250	1000	1300	23036W33MB	23036KW33MB	17,6	17,1	H3036	AH3036	KM38	192	268	2	0,26	2,7	3,7	2,5
	280	100	2,1	1006,8	1860,8	950	1300	24036EW33J	24036EKW33J	22,9	22,6	-	AH24036	KM38	192	268	2	0,32	2,1	3,1	2
	280	100	2,1	1000,8	1849,3	950	1300	24036W33M	24036KW33M	23,4	22,8	-	AH24036	KM38	192	268	2	0,32	2,1	3,1	2
	280	100	2,1	1000,8	1849,3	950	1300	24036W33MB	24036KW33MB	23,4	22,8	-	AH24036	KM38	192	268	2	0,32	2,1	3,1	2
	300	96	3	1104,5	1895,3	940	1200	23136EW33J	23136EKW33J	27,6	26,7	H3136	AH3136	KM40	194	286	2,5	0,3	2,3	3,2	2,1
	300	96	3	957	1540	940	1200	23136W33M	23136KW33M	28,9	28	H3136	AH3136	KM40	194	286	2,5	0,32	2,1	3	2
	300	96	3	957	1540	940	1200	23136W33MB	23136KW33MB	28,9	28	H3136	AH3136	KM40	194	286	2,5	0,32	2,1	3	2
	300	118	3	1280,1	2268,3	630	800	24136EW33J	24136EKW33J	32,9	32,4	-	AH24136	KM38	194	286	2,5	0,37	1,8	2,7	1,8
	300	118	3	1214,1	2115,3	630	800	24136W33M	24136KW33M	34	33,5	-	AH24136	KM38	194	286	2,5	0,37	1,8	2,7	1,8
	300	118	3	1214,1	2115,3	630	800	24136W33MB	24136KW33MB	34	33,5	-	AH24136	KM38	194	286	2,5	0,37	1,8	2,7	1,8
	320	86	4	1094	1697	1100	1400	22236EW33J	22236EKW33J	30,4	29,7	H3136	AH2236	KM40	198	302	3	0,27	2,5	3,6	2,4
	320	86	4	938	1640	1100	1400	22236W33M	22236KW33M	31,5	30,8	H3136	AH2236	KM40	198	302	3	0,28	2,4	3,4	2,3
	320	86	4	938	1640	1100	1400	22236W33MB	22236KW33MB	31,5	30,8	H3136	AH2236	KM40	198	302	3	0,28	2,4	3,4	2,3
	320	112	4	1280,5	2106,2	900	1200	23236EW33J	23236EKW33J	37,8	36,6	H3136	AH2236	KM40	198	302	3	0,28	2,4	3,4	2,3
	320	112	4	1277,6	2060,3	900	1200	23236W33M	23236KW33M	39,8	38,6	H3136	AH2236	KM40	198	302	3	0,28	2,4	3,4	2,3
320	112	4	1277,6	2060,3	900	1200	23236W33MB	23236KW33MB	39,8	38,6	H3136	AH2236	KM40	198	302	3	0,28	2,4	3,4	2,3	
380	126	4	1709,1	2434,8	890	1100	22336EW33J	22336EKW33J	70,6	68,9	H2336	AH2336	KM40	198	362	3	0,33	2,2	3,2	2	
380	126	4	1540	2130	890	1100	22336W33M	22336KW33M	73,2	71,7	H2336	AH2336	KM40	198	362	3	0,37	1,8	2,6	1,7	
380	126	4	1540	2130	890	1100	22336W33MB	22336KW33MB	73,2	71,7	H2336	AH2336	KM40	198	362	3	0,37	1,8	2,6	1,7	
190	260	52	2	500	953,1	1700	2200	23938EW33J	23938EKW33J	8,05	7,79	H3938	-	-	200	250	2	0,17	3,9	5,8	3,8
	290	75	2,1	809,3	1446,7	1300	1700	23038EW33J	23038EKW33J	17,4	16,9	H3038	AH3038	HML41T	202	278	2	0,25	2,7	3,8	2,5
	290	75	2,1	753	1340	940	1200	23038W33M	23038KW33M	18,8	18,3	H3038	AH3038	HML41T	202	278	2	0,24	2,7	3,9	2,5
	290	75	2,1	753	1340	940	1200	23038W33MB	23038KW33MB	18,8	18,3	H3038	AH3038	HML41T	202	278	2	0,24	2,7	3,9	2,5
	290	100	2,1	1069,4	2076,4	920	1250	24038EW33J	24038EKW33J	23,7	23,3	-	AH24038	KM40	202	278	2	0,31	2,2	3,2	2,1
	320	104	3	1283,3	2215,1	890	1100	23138EW33J	23138EKW33J	35,8	34,7	H3138	AH3138	HM42T	204	306	2,5	0,25	2,7	3,9	2,6
320	104	3	1130	1840	890	1100	23138W33M	23138KW33M	36,1	35	H3138	AH3138	HM42T	204	306	2,5	0,32	2,1	3	2	

DOUBLE ROW SPHERICAL ROLLER BEARINGS ZVL SLOVAKIA, a. s.

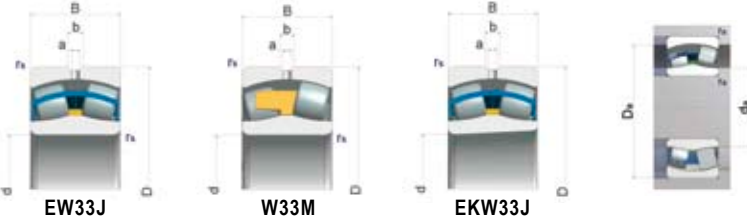

DIMENSIONS mm			BASIC LOAD RATING kN	LIMITING SPEED FOR LUBRICATION min ⁻¹	BEARING DESIGNATION		WEIGHT kg		ACCESSORIES			ABUTMENT AND FILLET DIMENSIONS			COEFFICIENTS						
d	D	B			CYLINDRICAL BORE	TAPERED BORE (1 : 12)	K	ADAPTER SLEEVE	WITH DRAWAL SLEEVE	WITH DRAWAL NUT	da min	Da max	ra max	e	Y ₁	Y ₂	Y ₃				
220	400	144	4	2016.6	3326.7	710	840	23244W33M	23244KW33M	83	79	H2344	AH2344	HM48T	238	382	3	0.36	1.9	2.8	1.8
	400	144	4	2016.6	3326.7	710	840	23244W33M	23244KW33M	83	79	H2344	AH2344	HM48T	238	382	3	0.36	1.9	2.8	1.8
	460	145	5	2417.1	3511.9	750	890	22344EKW33J	22344EKW33J	121	118	H2344	AH2344	HM48T	242	438	4	0.33	2.2	3.2	2
	460	145	5	2365.3	3532.5	750	890	22344W33M	22344KW33M	125	122	H2344	AH2344	HM48T	242	438	4	0.35	1.9	2.8	1.8
240	320	60	2.1	653.1	1340.7	1300	1700	23948EW33J	23948EKW33J	13.3	13	H3948	-	-	252	308	2	0.15	4.5	6.6	4.4
	320	60	2.1	543.4	1244.1	1300	1700	23948W33M	23948KW33M	14	13.7	H3948	-	-	252	308	2	0.15	4.5	6.6	4.4
	360	92	3	1191.5	2204.1	750	890	23048EW33J	23048EKW33J	28.9	27.8	H3048	AH3048	HML52T	254	346	2.5	0.24	3.1	4	3
	360	92	3	1050	2310	750	890	23048W33M	23048KW33M	32.4	31.4	H3048	AH3048	HML52T	254	346	2.5	0.25	2.7	4.1	2.7
	360	92	3	1050	2310	750	890	23048W33M	23048KW33M	32.4	31.4	H3048	AH3048	HML52T	254	346	2.5	0.25	2.7	4.1	2.7
	360	118	3	1469.9	2914.4	800	1000	24048EW33J	24048EKW33J	41	40.7	-	AOH24048	HM50T	254	346	2.5	0.3	2.3	3.4	2.2
	360	118	3	1332.7	2702.8	800	1000	24048W33M	24048KW33M	42.8	42.1	-	AOH24048	HM50T	254	346	2.5	0.3	2.3	3.4	2.2
	360	118	3	1332.7	2702.8	800	1000	24048W33M	24048KW33M	42.8	42.1	-	AOH24048	HM50T	254	346	2.5	0.3	2.3	3.4	2.2
	400	128	4	1911.5	3372.2	710	840	23148EW33J	23148EKW33J	67.4	65.4	H3148	AH3148	HM52T	258	382	3	0.25	2.7	3.9	2.6
	400	128	4	1845.4	3241.9	710	840	23148W33M	23148KW33M	68.7	66.7	H3148	AH3148	HM52T	258	382	3	0.31	2	3	2
	400	128	4	1845.4	3241.9	710	840	23148W33M	23148KW33M	68.7	66.7	H3148	AH3148	HM52T	258	382	3	0.31	2	3	2
	400	160	4	2230.7	4123.2	480	600	24148EW33J	24148EKW33J	80	79.2	-	AOH24148	HM50T	258	382	3	0.37	1.7	2.7	1.8
	400	160	4	2127.6	3906.5	480	600	24148W33M	24148KW33M	82.5	81.3	-	AOH24148	HM50T	258	382	3	0.37	1.7	2.7	1.8
	400	160	4	2127.6	3906.5	480	600	24148W33M	24148KW33M	82.5	81.3	-	AOH24148	HM50T	258	382	3	0.37	1.7	2.7	1.8
	440	120	4	2072.1	3295.7	900	1200	22248EW33J	22248EKW33J	80	78.2	H3148	AH2248	HM52T	258	422	3	0.26	2.6	3.9	2.6
	440	120	4	2037.7	3225.6	900	1200	22248W33M	22248KW33M	85	83.2	H3148	AH2248	HM52T	258	422	3	0.26	2.6	3.9	2.6
	440	120	4	2037.7	3225.6	900	1200	22248W33M	22248KW33M	85	83.2	H3148	AH2248	HM52T	258	422	3	0.26	2.6	3.9	2.6
	440	160	4	2477.7	4149.5	670	850	23248EW33J	23248EKW33J	105	102	H2348	AH2348	HM52T	258	422	3	0.35	1.9	2.9	1.8
	440	160	4	2477.7	4149.5	670	850	23248W33M	23248KW33M	111	108	H2348	AH2348	HM52T	258	422	3	0.35	1.9	2.9	1.8
	440	160	4	2477.7	4149.5	670	850	23248W33M	23248KW33M	111	108	H2348	AH2348	HM52T	258	422	3	0.35	1.9	2.9	1.8
	500	155	5	2734.4	4037.3	670	790	22348EW33J	22348EKW33J	154	151	H2348	AH2348	HM52T	262	478	4	0.33	2.2	3.2	2
	500	155	5	2780.5	4086.3	670	790	22348W33M	22348KW33M	159	156	H2348	AH2348	HM52T	262	478	4	0.34	2	2.9	1.9
	500	155	5	2780.5	4086.3	670	790	22348W33M	22348KW33M	159	156	H2348	AH2348	HM52T	262	478	4	0.34	2	2.9	1.9
	260	360	75	2.1	986.1	1984.3	1100	1500	23952EW33J	23952EKW33J	22.9	22.2	H3952	-	-	272	348	2	0.18	3.7	5.5
360		75	2.1	894.4	1884.4	1100	1500	23952W33M	23952KW33M	23.4	21.7	H3952	-	-	272	348	2	0.18	3.7	5.5	3.7
400		104	4	1513	2909.5	890	1200	23052EW33J	23052EKW33J	45.8	44.4	H3052	AH3052	HML56T	278	382	3	0.24	3.1	4	3
400		104	4	1395	2720	670	790	23052W33M	23052KW33M	46.8	45.3	H3052	AH3052	HML56T	278	382	3	0.25	2.7	3.9	2.6
400		104	4	1395	2720	670	790	23052W33M	23052KW33M	46.8	45.3	H3052	AH3052	HML56T	278	382	3	0.25	2.7	3.9	2.6
400		140	4	1920.4	3923.2	700	900	24052EW33J	24052EKW33J	64	62.9	-	AOH24052	HM54T	278	382	3	0.32	2.1	3.1	2.1
400		140	4	1787.6	3396.6	700	900	24052W33M	24052KW33M	65	63.9	-	AOH24052	HM54T	278	382	3	0.32	2.1	3.1	2.1
400		140	4	1787.6	3396.6	700	900	24052W33M	24052KW33M	65	63.9	-	AOH24052	HM54T	278	382	3	0.32	2.1	3.1	2.1
440		144	4	2259.9	4021.3	670	790	23152EW33J	23152EKW33J	87.3	85.6	H3152	AH3152	HM58T	278	422	3	0.32	2	3.1	2
440		144	4	2229	3982.5	670	790	23152W33M	23152KW33M	90.5	87.8	H3152	AH3152	HM58T	278	422	3	0.32	2	3.1	2
440		144	4	2229	3982.5	670	790	23152W33M	23152KW33M	90.5	87.8	H3152	AH3152	HM58T	278	422	3	0.32	2	3.1	2
440		180	4	2679.8	4976	430	530	24152EW33J	24152EKW33J	110.8	108.8	-	AOH24152	HM56T	278	422	3	0.39	1.8	2.6	1.7
440		180	4	2566.5	4707	430	530	24152W33M	24152KW33M	115	113	-	AOH24152	HM56T	278	422	3	0.39	1.8	2.6	1.7
440		180	4	2566.5	4707	430	530	24152W33M	24152KW33M	115	113	-	AOH24152	HM56T	278	422	3	0.39	1.8	2.6	1.7
480		130	5	2437.2	4007.7	670	790	22252EW33J	22252EKW33J	107.6	105.6	H3152	AH2252	HM58T	282	458	4	0.29	2.3	3.4	2.2
480		130	5	2279.4	3574.1	670	790	22252W33M	22252KW33M	111	109	H3152	AH2252	HM58T	282	458	4	0.29	2.3	3.4	2.2
480		130	5	2279.4	3574.1	670	790	22252W33M	22252KW33M	111	109	H3152	AH2252	HM58T	282	458	4	0.29	2.3	3.4	2.2
480		174	5	2919.4	4985.7	600	710	23252EW33J	23252EKW33J	140	135	H2352	AH2352	HM58T	282	458	4	0.37	1.8	2.6	1.7
480		174	5	2914.4	4917.9	600	710	23252W33M	23252KW33M	147	142	H2352	AH2352	HM58T	282	458	4	0.33	2.2	3.2	2
480		174	5	2914.4	4917.9	600	710	23252W33M	23252KW33M	147	142	H2352	AH2352	HM58T	282	458	4	0.33	2.2	3.2	2
540		165	6	3215.8	4756	600	710	22352W33M	22352KW33M	196	192	H2352	AH2352	HM58T	288	512	5	0.34	2	2.9	1.9
540		165	6	3215.8	4756	600	710	22352W33M	22352KW33M	196	192	H2352	AH2352	HM58T	288	512	5	0.34	2	2.9	1.9

DOUBLE ROW SPHERICAL ROLLER BEARINGS ZVL SLOVAKIA, a. s.

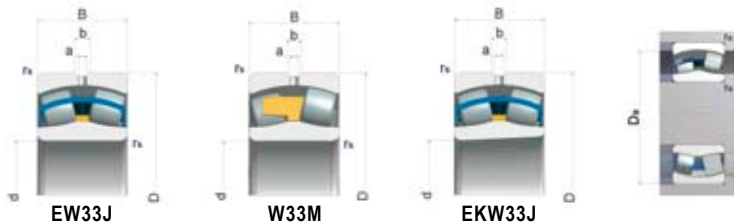

EW33J

W33M

EKW33J

DIMENSIONS mm			BASIC LOAD RATING kN	LIMITING SPEED FOR LUBRICATION min ⁻¹	BEARING DESIGNATION		WEIGHT kg	ACCESSORIES			ABUTMENT AND FILLET DIMENSIONS			COEFFICIENTS							
d	D	B	rs min			CYLINDRICAL BORE	TAPERED BORE (1 : 12)	K	ADAPTER SLEEVE	WITH DRAWAL SLEEVE	WITH DRAWAL NUT	da min	Da max	ra max	e	Y ₁	Y ₂	Y ₃			
280	380	75	2,1	879,8	1849,7	1000	1400	23956EW33J	23956EKW33J	25	24,2	H3956	-	-	292	368	2	0,16	4,1	6,3	4
	420	106	4	1635,8	3145,1	850	1100	23056EW33J	23056EKW33J	50	48,4	H3056	AH3056	HM3060	298	402	3	0,24	3,1	4	3
	420	106	4	1593,6	3041,3	850	1100	23056W33M	23056KW33M	54,5	52,9	H3056	AH3056	HM3060	298	402	3	0,24	2,7	4	2,6
	420	106	4	1593,6	3041,3	850	1100	23056W33MB	23056KW33MB	54,5	52,9	H3056	AH3056	HM3060	298	402	3	0,24	2,7	4	2,6
	420	140	4	1928,2	3893,3	670	850	24056EW33J	24056EKW33J	69	68,2	-	AOH24056	HM52T	298	402	3	0,3	2,2	3,3	2,2
	420	140	4	1940,2	3847	670	850	24056W33M	24056KW33M	69,7	68,6	-	AOH24056	HM52T	298	402	3	0,3	2,2	3,3	2,2
	420	140	4	1940,2	3847	670	850	24056W33MB	24056KW33MB	69,7	68,6	-	AOH24056	HM52T	298	402	3	0,3	2,2	3,3	2,2
	460	146	5	2325,8	4277,6	750	950	23156EW33J	23156EKW33J	99	95	H3156	AH3156	HM62T	302	438	4	0,31	2,1	3	2
	460	146	5	2388,2	4361,7	750	950	23156W33M	23156KW33M	103	99	H3156	AH3156	HM62T	302	438	4	0,3	2,2	3	2,1
	460	146	5	2388,2	4361,7	750	950	23156W33MB	23156KW33MB	103	99	H3156	AH3156	HM62T	302	438	4	0,3	2,2	3	2,1
	460	180	5	2694,2	5189,9	400	500	24156EW33J	24156EKW33J	118	116	-	AOH24156	HM63160	302	438	4	0,37	1,8	2,7	1,8
	460	180	5	2645,2	4980,4	400	500	24156W33M	24156KW33M	121	119	-	AOH24156	HM63160	302	438	4	0,37	1,8	2,7	1,8
	460	180	5	2645,2	4980,4	400	500	24156W33MB	24156KW33MB	121	119	-	AOH24156	HM63160	302	438	4	0,37	1,8	2,7	1,8
	500	130	5	2607,7	4268,9	630	750	22256EW33J	22256EKW33J	117	114	H3156	AH2256	HM62T	302	478	4	0,28	2,4	3,5	2,3
	500	130	5	2299,9	3616,1	630	750	22256W33M	22256KW33M	119	116	H3156	AH2256	HM62T	302	478	4	0,28	2,4	3,5	2,3
	500	130	5	2299,9	3616,1	630	750	22256W33MB	22256KW33MB	119	116	H3156	AH2256	HM62T	302	478	4	0,28	2,4	3,5	2,3
	500	176	5	2928,7	4961,9	560	670	23256EW33J	23256EKW33J	154,5	149,5	H2356	AH2356	HM62T	302	478	4	0,36	1,9	2,7	1,8
	500	176	5	3117,7	5436,6	560	670	23256W33M	23256KW33M	157	152	H2356	AH2356	HM62T	302	478	4	0,3	2,1	3,2	2
	500	176	5	3117,7	5436,6	560	670	23256W33MB	23256KW33MB	157	152	H2356	AH2356	HM62T	302	478	4	0,3	2,1	3,2	2
	580	175	6	3722	5705,6	600	750	22356W33M	22356KW33M	232	227	H2356	AH2356	HM62T	308	552	5	0,31	2,2	3,2	2,1
580	175	6	3722	5705,6	600	750	22356W33MB	22356KW33MB	232	227	H2356	AH2356	HM62T	308	552	5	0,31	2,2	3,2	2,1	
300	420	90	3	1264	2608,6	950	1300	23960EW33J	23960EKW33J	35,8	34,5	H3960	-	-	314	406	2,5	0,19	3,6	5,4	3,5
	420	90	3	1287,6	2609	950	1300	23960W33M	23960KW33M	38,3	37	H3960	-	-	314	406	2,5	0,2	3,5	5,2	3,4
	460	118	4	1928,9	3628,9	800	1000	23060EW33J	23060EKW33J	69,6	67,5	H3060	AH3060	HM3064	318	442	3	0,25	2,7	3,8	2,5
	460	118	4	1945	3667,9	750	1000	23060W33M	23060KW33M	75,8	73,6	H3060	AH3060	HM3064	318	442	3	0,25	2,7	3,8	2,5
	460	118	4	1945	3667,9	750	1000	23060W33MB	23060KW33MB	75,8	73,6	H3060	AH3060	HM3064	318	442	3	0,25	2,7	3,8	2,5
	460	160	4	2407,3	4976,3	600	750	24060EW33J	24060EKW33J	95	93,7	-	AOH24060	HM62T	318	442	3	0,32	2,1	3,2	2,1
	460	160	4	2319,5	4688,9	600	750	24060W33M	24060KW33M	97,7	96,2	-	AOH24060	HM62T	318	442	3	0,32	2,1	3,2	2,1
	460	160	4	2319,5	4688,9	600	750	24060W33MB	24060KW33MB	97,7	96,2	-	AOH24060	HM62T	318	442	3	0,32	2,1	3,2	2,1
	500	160	5	2760,1	5143	530	630	23160EW33J	23160EKW33J	129	125	H3160	AH3160	HM66T	322	478	4	0,32	2,1	3	2
	500	160	5	2764,1	5006	530	630	23160W33M	23160KW33M	134	130	H3160	AH3160	HM66T	322	478	4	0,32	2,1	3	2
	500	160	5	2764,1	5006	530	630	23160W33MB	23160KW33MB	134	130	H3160	AH3160	HM66T	322	478	4	0,32	2,1	3	2
	500	200	5	3268,8	6196,2	360	450	24160EW33J	24160EKW33J	158	155	-	AOH24160	HM3164	322	478	4	0,37	1,8	2,7	1,8
	500	200	5	3037,3	5670,8	360	450	24160W33M	24160KW33M	163	160	-	AOH24160	HM3164	322	478	4	0,37	1,8	2,7	1,8
	500	200	5	3037,3	5670,8	360	450	24160W33MB	24160KW33MB	163	160	-	AOH24160	HM3164	322	478	4	0,37	1,8	2,7	1,8
540	140	5	2571,3	4161,5	560	670	22260W33M	22260KW33M	150	147	H3160	AH2260	HM66T	322	518	4	0,27	2,5	3,6	2,4	
540	140	5	2571,3	4161,5	560	670	22260W33MB	22260KW33MB	150	147	H3160	AH2260	HM66T	322	518	4	0,27	2,5	3,6	2,4	
540	192	5	3570,3	6091,7	550	630	23260W33M	23260KW33M	200	195	H3260	AH3260	HM66T	322	518	4	0,36	1,8	2,7	1,8	
540	192	5	3570,3	6091,7	550	630	23260W33MB	23260KW33MB	200	195	H3260	AH3260	HM66T	322	518	4	0,36	1,8	2,7	1,8	
320	480	121	4	1972	3796	530	630	23064EW33J	23064EKW33J	79,3	76,9	H3064	AH3064	HML69T	338	462	3	0,24	2,7	3,9	2,6
	480	121	4	2021,3	3918,5	530	630	23064W33M	23064KW33M	81,2	78,8	H3064	AH3064	HML69T	338	462	3	0,24	2,7	3,9	2,6
	480	121	4	2021,3	3918,5	530	630	23064W33MB	23064KW33MB	81,2	78,8	H3064	AH3064	HML69T	338	462	3	0,24	2,7	3,9	2,6
	480	160	4	2523,7	5388,7	560	700	24064EW33J	24064EKW33J	100	98,5	-	AOH24064	HM66T	338	462	3	0,3	2,2	3,3	2,2
	480	160	4	2443	5015,8	560	700	24064W33M	24064KW33M	103	101,5	-	AOH24064	HM66T	338	462	3	0,3	2,2	3,3	2,2
	480	160	4	2443	5015,8	560	700	24064W33MB	24064KW33MB	103	101,5	-	AOH24064	HM66T	338	462	3	0,3	2,2	3,3	2,2
	540	176	5	3416,1	6077,1	630	800	23164W33M	23164KW33M	175	170	H3164	AH3164	HM70T	342	518	4	0,32	2	3	2
	540	176	5	3416,1	6077,1	630	800	23164W33MB	23164KW33MB	175	170	H3164	AH3164	HM70T	342	518	4	0,32	2	3	2
	540	218	5	3767,2	7167,8	340	430	24164W33M	24164KW33M	208	205	-	AOH24164	HM3168	342	518	4	0,38	1,8	2,6	1,7
	540	218	5	3767,2	7167,8	340	430	24164W33MB	24164KW33MB	208	205	-	AOH24164	HM3168	342	518	4	0,38	1,8	2,6	1,7



DOUBLE ROW SPHERICAL ROLLER BEARINGS ZVL SLOVAKIA, a. s.

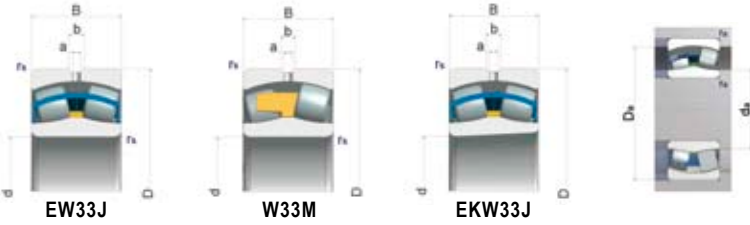

DIMENSIONS mm				BASIC LOAD RATING kN	LIMITING SPEED FOR LUBRICATION min ⁻¹	BEARING DESIGNATION		WEIGHT kg		ACCESSORIES			ABUTMENT AND FILLER DIMENSIONS			COEFFICIENTS					
d	D	B	rs min			CYLINDRICAL BORE	TAPERED BORE (1 : 12)	K	ADAPTER SLEEVE	WITH DRAWAL SLEEVE	WITH DRAWAL NUT	da min	Da max	ra max	e	Y ₁	Y ₂	Y ₃			
320	580	150	5	3214,6	6255,8	530	630	22264W33M	22264KW33M	187	181	H3164	AH2264	HM70T	342	558	4	0,27	2,5	3,6	2,3
	580	150	5	3214,6	6255,8	530	630	22264W33MB	22264KW33MB	187	181	H3164	AH2264	HM70T	342	558	4	0,27	2,5	3,6	2,3
	580	208	5	4080	7328,9	450	550	23264W33M	23264KW33M	253	246	H3264	AH3264	HM70T	342	558	4	0,37	1,8	2,6	1,7
	580	208	5	4080	7328,9	450	550	23264W33MB	23264KW33MB	253	246	H3264	AH3264	HM70T	342	558	4	0,37	1,8	2,6	1,7
340	520	133	5	2455,9	4702,1	500	600	23068EW33J	23068EKW33J	106,3	13,3	H3068	AH3068	HML73T	354	446	2,5	0,25	2,7	3,9	2,6
	520	133	5	2390,2	4650,7	500	600	23068W33M	23068KW33M	108	105	H3068	AH3068	HML73T	354	446	2,5	0,25	2,7	3,9	2,6
	520	133	5	2390,2	4650,7	500	600	23068W33MB	23068KW33MB	108	105	H3068	AH3068	HML73T	354	446	2,5	0,25	2,7	3,9	2,6
	520	180	5	3091,9	6455,5	530	670	24068EW33J	24068EKW33J	138	136	-	AOH24068	HM3072	354	446	2,5	0,33	2	3	2
	520	180	5	2901,7	6087,7	530	670	24068W33M	24068KW33M	141	139	-	AOH24068	HM3072	354	446	2,5	0,33	2	3	2
	520	180	5	2901,7	6087,7	530	670	24068W33MB	24068KW33MB	141	139	-	AOH24068	HM3072	354	446	2,5	0,33	2	3	2
	580	190	5	3831,8	6868,1	600	750	23168W33M	23168KW33M	206	199	H3168	AH3168	HM74T	362	558	4	0,33	2	2,9	1,9
	580	190	5	3831,8	6868,1	600	750	23168W33MB	23168KW33MB	206	199	H3168	AH3168	HM74T	362	558	4	0,33	2	2,9	1,9
360	620	224	6	4606,7	8125,9	420	500	23268W33M	23268KW33M	314	305	H3268	AH3268	HM74T	368	592	5	0,37	1,8	2,6	1,7
	620	224	6	4606,7	8125,9	420	500	23268W33MB	23268KW33MB	314	305	H3268	AH3268	HM74T	368	592	5	0,37	1,8	2,6	1,7
	540	134	5	2544,6	4963,5	450	530	23072EW33J	23072EKW33J	113	110	H3072	AH3072	HML77T	382	518	4	0,24	2,8	4	2,6
	540	134	5	2499,4	4922,6	450	530	23072W33M	23072KW33M	115	112	H3072	AH3072	HML77T	382	518	4	0,24	2,8	4	2,6
380	540	134	5	2499,4	4922,6	450	530	23072W33MB	23072KW33MB	115	112	H3072	AH3072	HML77T	382	518	4	0,24	2,8	4	2,6
	540	180	5	3046,9	6370,9	450	560	24072W33M	24072KW33M	150	145	-	AOH24072	HM76T	382	518	4	0,33	2,1	3,1	2
	540	180	5	3046,9	6370,9	450	560	24072W33MB	24072KW33MB	150	145	-	AOH24072	HM76T	382	518	4	0,33	2,1	3,1	2
	600	192	5	3786,4	7178,8	420	500	23172W33M	23172KW33M	233	225	H3172	AH3172	HM80T	382	578	4	0,32	2	3	2
	600	192	5	3786,4	7178,8	420	500	23172W33MB	23172KW33MB	233	225	H3172	AH3172	HM80T	382	578	4	0,32	2	3	2
	600	243	5	4444,3	8846,1	300	380	24172W33M	24172KW33M	282	277	-	AOH24172	HM3176	382	578	4	0,38	1,8	2,6	1,7
	600	243	5	4444,3	8846,1	300	380	24172W33MB	24172KW33MB	282	277	-	AOH24172	HM3176	382	578	4	0,38	1,8	2,6	1,7
	650	232	6	5028,6	9012,9	400	500	23272W33M	23272KW33M	345	335	H3272	AH3272G	HM3076	388	622	5	0,35	1,9	2,9	1,8
	650	232	6	5028,6	9012,9	400	500	23272W33MB	23272KW33MB	345	335	H3272	AH3272G	HM3076	388	622	5	0,35	1,9	2,9	1,8
	400	560	135	5	2497,2	5151,2	420	500	23076W33M	23076KW33M	121	118	H3076	AH3076	HML82T	402	538	4	0,23	2,9	4,2
560		135	5	2497,2	5151,2	420	500	23076W33MB	23076KW33MB	121	118	H3076	AH3076	HML82T	402	538	4	0,23	2,9	4,2	2,7
560		180	5	3182,4	6836,4	480	600	24076W33M	24076KW33M	158	156	-	AOH24076	HM3080	402	538	4	0,29	2,3	3,5	2,3
560		180	5	3182,4	6836,4	480	600	24076W33MB	24076KW33MB	158	156	-	AOH24076	HM3080	402	538	4	0,29	2,3	3,5	2,3
620		194	5	4050,1	7734,6	400	470	23176W33M	23176KW33M	246	239	H3176	AH3176	HM84T	402	598	4	0,31	2,2	3,1	2,1
620		194	5	4050,1	7734,6	400	470	23176W33MB	23176KW33MB	246	239	H3176	AH3176	HM84T	402	598	4	0,31	2,2	3,1	2,1
620		243	5	4642,7	9259,9	280	360	24176W33M	24176KW33M	295	290	-	AOH24176	HM3180	402	598	4	0,36	1,9	2,8	1,8
620		243	5	4642,7	9259,9	280	360	24176W33MB	24176KW33MB	295	290	-	AOH24176	HM3180	402	598	4	0,36	1,9	2,8	1,8
420	680	240	6	5208,6	9345,3	380	480	23276W33M	23276KW33M	395	383	H3276	AH3276	HM48T	408	652	5	0,36	1,9	2,7	1,8
	680	240	6	5208,6	9345,3	380	480	23276W33MB	23276KW33MB	395	383	H3276	AH3276	HM48T	408	652	5	0,36	1,9	2,7	1,8
	600	148	5	2790	6050	400	470	23080W33M	23080KW33M	156	152	H3080	AH3080	HML86T	422	578	4	0,24	2,8	4	2,7
	600	148	5	2790	6050	400	470	23080W33MB	23080KW33MB	156	152	H3080	AH3080	HML86T	422	578	4	0,24	2,8	4	2,7
480	650	200	6	4184	7960,7	380	450	23180W33M	23180KW33M	275	267	H3180	AH3180	HM88T	428	622	5	0,3	2,2	3,2	2,1
	650	200	6	4184	7960,7	380	450	23180W33MB	23180KW33MB	275	267	H3180	AH3180	HM88T	428	622	5	0,3	2,2	3,2	2,1
	650	250	6	4883,7	9793,9	380	240	24180W33M	24180KW33M	336	331	-	AH24180	HM3184	428	622	5	0,35	1,9	2,8	1,9
	650	250	6	4883,7	9793,9	380	240	24180W33MB	24180KW33MB	336	331	-	AH24180	HM3184	428	622	5	0,35	1,9	2,8	1,9
	720	256	6	5791,2	10606,8	350	420	23280W33M	23280KW33M	475	462	H3280	AH3280	HM88T	428	692	5	0,36	1,8	2,7	1,8
	720	256	6	5791,2	10606,8	350	420	23280W33MB	23280KW33MB	475	462	H3280	AH3280	HM88T	428	692	5	0,36	1,8	2,7	1,8
420	620	150	5	3122,3	6385	380	450	23084W33M	23084KW33M	164	159	H3084	AH3084	HML90T	442	598	4	0,23	2,9	4,1	2,7
	620	150	5	3122,3	6385	380	450	23084W33MB	23084KW33MB	164	159	H3084	AH3084	HML90T	442	598	4	0,23	2,9	4,1	2,7
	700	224	6	5122,3	9733,8	360	450	23184W33M	23184KW33M	360	345	H3184	AH3184	HM92T	448	672	5	0,32	2,1	3,2	2
700	224	6	5122,3	9733,8	360	450	23184W33MB	23184KW33MB	360	345	H3184	AH3184	HM92T	448	672	5	0,32	2,1	3,2	2	

DOUBLE ROW SPHERICAL ROLLER BEARINGS ZVL SLOVAKIA, a. s.

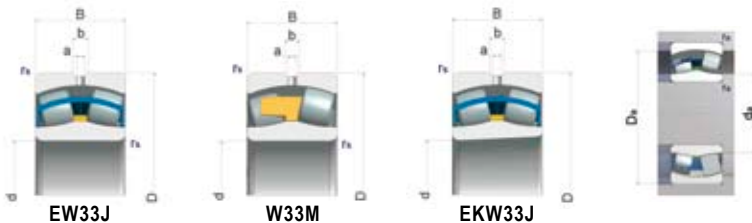

DIMENSIONS mm			BASIC LOAD RATING kN	LIMITING SPEED FOR LUBRICATION min ⁻¹	BEARING DESIGNATION		WEIGHT kg		ACCESSORIES			ABUTMENT AND FILLET DIMENSIONS			COEFFICIENTS							
d	D	B	rs min	C	Co	CYLINDRICAL BORE	TAPERED BORE (1 : 12)	K	ADAPTER SLEEVE	WITH DRAWAL SLEEVE	WITH DRAWAL NUT	da min	Da max	ra max	e	Y ₁	Y ₂	Y ₃				
420	700	280	6	5607,5	11183,8	170	220	24184W33M	24184KW33M	446	440	-	AOH24184	HM3188	448	672	5	0,37	1,8	2,7	1,8	
	700	280	6	5607,5	11183,8	170	220	24184W33MB	24184KW33MB	446	440	-	AOH24184	HM3188	448	672	5	0,37	1,8	2,7	1,8	
	760	272	7,5	6730,9	12446,6	320	400	23284W33M	23284KW33M	535	520	H3284	AH3284	HM92T	456	724	6	0,36	1,7	2,7	1,8	
	760	272	7,5	6730,9	12446,6	320	400	23284W33MB	23284KW33MB	535	520	H3284	AH3284	HM92T	456	724	6	0,36	1,7	2,7	1,8	
440	650	157	6	3375,3	6926,4	350	420	23088W33M	23088KW33M	186	180	H3088	AH3088X	HML94T	468	622	5	0,23	2,9	4,1	2,7	
	650	157	6	3375,3	6926,4	350	420	23088W33MB	23088KW33MB	186	180	H3088	AH3088X	HML94T	468	622	5	0,23	2,9	4,1	2,7	
	720	226	6	4985,7	9757,6	330	400	23188W33M	23188KW33M	388	377	H3188	AH3188X	HM96T	468	692	5	0,32	2,1	3	2	
	720	226	6	4985,7	9757,6	330	400	23188W33MB	23188KW33MB	388	377	H3188	AH3188X	HM96T	468	692	5	0,32	2,1	3	2	
	790	280	7,5	7032,6	12966,6	320	380	23288W33M	23288KW33M	615	597	H3288	AH3288X	HM96T	476	754	6	0,36	1,8	2,7	1,8	
790	280	7,5	7032,6	12966,6	320	380	23288W33MB	23288KW33MB	615	597	H3288	AH3288X	HM96T	476	754	6	0,36	1,8	2,7	1,8		
460	680	163	6	3652,4	7523,6	330	400	23092W33M	23092KW33M	214	207	H3092	AH3092X	HML98T	488	652	5	0,23	2,9	4,2	2,8	
	680	163	6	3652,4	7523,6	330	400	23092W33MB	23092KW33MB	214	207	H3092	AH3092X	HML98T	488	652	5	0,23	2,9	4,2	2,8	
	760	240	7,5	6024,9	11764,2	320	380	23192W33M	23192KW33M	456	441	H3192	AH3192	HM102T	496	724	6	0,31	2,1	3,1	2	
	760	240	7,5	6024,9	11764,2	320	380	23192W33MB	23192KW33MB	456	441	H3192	AH3192	HM102T	496	724	6	0,31	2,1	3,1	2	
760	300	7,5	7218,8	14885,6	160	200	24192W33M	24192KW33M	556	547	-	-	-	496	724	6	0,37	1,8	2,7	1,8		
480	700	165	6	3673,4	7672,3	320	380	23096W33M	23096KW33M	235	228	H3096	AH3096X	HML104T	508	672	5	0,23	2,9	4,4	2,9	
	700	165	6	3673,4	7672,3	320	380	23096W33MB	23096KW33MB	235	228	H3096	AH3096X	HML104T	508	672	5	0,23	2,9	4,4	2,9	
	790	248	7,5	6340,5	12600,8	300	380	23196W33M	23196KW33M	482	467	H3196	AH3196X	HML106T	516	754	6	0,31	2,2	3,1	2,1	
	790	248	7,5	6340,5	12600,8	300	380	23196W33MB	23196KW33MB	482	467	H3196	AH3196X	HML106T	516	754	6	0,31	2,2	3,1	2,1	
500	720	167	6	3676,2	8088,4	300	350	230500W33M	230500KW33M	236	228	H30/500	AH30/500X	HML108T	528	692	5	0,22	3	4,3	2,9	
	720	167	6	3676,2	8088,4	300	350	230500W33MB	230500KW33MB	236	228	H30/500	AH30/500X	HML108T	528	692	5	0,22	3	4,3	2,9	
	830	264	7,5	6931,8	14161,3	280	330	231500W33M	231500KW33M	572	552	H31/500	AH31/500X	HM110T	536	794	6	0,31	2,1	3	2	
	830	264	7,5	6931,8	14161,3	280	330	231500W33MB	231500KW33MB	572	552	H31/500	AH31/500X	HM110T	536	794	6	0,31	2,1	3	2	
530	780	185	6	4302,4	9358,3	280	330	230530W33M	230530KW33M	318	309	H30/530	AH30/530	HML112T	558	752	5	0,22	3	4,3	2,9	
	780	185	6	4302,4	9358,3	280	330	230530W33MB	230530KW33MB	318	309	H30/530	AH30/530	HML112T	558	752	5	0,22	3	4,3	2,9	
560	820	195	6	5302,1	11368,7	320	400	230560W33M	230560KW33M	357	345	H30/560	AH30/560	HML118T	588	792	5	0,22	3,1	4,6	3	
	820	195	6	5302,1	11368,7	320	400	230560W33MB	230560KW33MB	357	345	H30/560	AH30/560	HML118T	588	792	5	0,22	3,1	4,6	3	
600	870	200	6	5649,2	12402,6	260	320	230600W33M	230600KW33M	399	394	H30/600	AH30/600	HM30/630	628	842	5	0,22	2,9	4,2	2,8	
	870	200	6	5649,2	12402,6	260	320	230600W33MB	230600KW33MB	399	394	H30/600	AH30/600	HM30/630	628	842	5	0,22	2,9	4,2	2,8	
630	920	212	7,5	6299,5	13874,8	340	300	230630W33M	230630KW33M	484	469	H30/630	AH30/630	HM30/670	666	884	6	0,21	3,1	4,5	2,9	
	920	212	7,5	6299,5	13874,8	340	300	230630W33MB	230630KW33MB	484	469	H30/630	AH30/630	HM30/670	666	884	6	0,21	3,1	4,5	2,9	
670	980	230	7,5	5541,6	12537,9	200	280	230670W33M	230670KW33M	615	597	H30/670	AH30/670	HM30/710	706	944	6	0,23	3	4,4	2,9	
	980	230	7,5	5541,6	12537,9	200	280	230670W33MB	230670KW33MB	615	597	H30/670	AH30/670	HM30/710	706	944	6	0,23	3	4,4	2,9	
800	1150	258	7,5	9152,9	20660,4	180	220	230800W33M	230800KW33M	935	907	H30/800	AH30/800	HM30/850	836	1114	6	0,21	3,1	4,5	3	
	1150	258	7,5	9152,9	20660,4	180	220	230800W33MB	230800KW33MB	935	907	H30/800	AH30/800	HM30/850	836	1114	6	0,21	3,1	4,5	3	
850	1220	272	7,5	9593,3	21834,2	160	200	230850W33M	230850KW33M	1112	1082	-	-	AH30/850	HM30/900	886	1184	6	0,21	3,1	4,5	3
	1220	272	7,5	9593,3	21834,2	160	200	230850W33MB	230850KW33MB	1112	1082	-	-	AH30/850	HM30/900	886	1184	6	0,21	3,1	4,5	3





SINGLE DIRECTION AND DOUBLE DIRECTION THRUST BALL BEARINGS



SINGLE DIRECTION AND DOUBLE DIRECTION THRUST BALL BEARINGS

In terms of construction the thrust ball bearings are divided into single direction and double direction thrust ball bearings.

Single Direction Thrust Ball Bearings

consist of two flat washers with raceways, balls and cage. The washers have a flat seating surface therefore they have to be embedded so that all balls are equally loaded.

Double Direction Thrust Ball Bearings

have two cages with balls between the central shaft washer and both housing washers with flat seating surface.

Single direction and double direction thrust ball bearings can accommodate large axial load, however they must not be subjected to radial load. During operation these bearings must be constantly subjected to a specific axial load.



DESIGN SPECIFICATIONS

MAIN DIMENSIONS

Main dimensions of thrust ball bearings specified in the dimension tables are in accordance with the international standards ISO 104.

DESIGNATION

Designation of standard applications is specified in the dimension tables. Difference from basic application is marked by additional symbols.

CAGE

Thrust ball bearings have as standard steel cage, where the material and application is not marked. Special construction requests should be discussed with the supplier in advance.

TOLERANCE

Thrust ball bearings are commonly produced in the tolerance class P0 that is not marked. For more demanding kinds of seating bearings with higher tolerance class P6 or P5 can be supplied.

MISALIGNMENT

The seating of thrust ball bearings requires as accurate alignment of seating surfaces as possible, because the misalignment of the seating surfaces causes increased stress in the contact of balls with the raceways. It is not recommended to use thrust ball bearings where the conditions of alignment cannot be met.

AXIAL EQUIVALENT DYNAMIC LOAD

$$P_a = F_a \quad (\text{kN})$$

RADIAL EQUIVALENT STATIC LOAD

$$P_{oa} = F_a \quad (\text{kN})$$

MINIMAL AXIAL LOAD

When the axial load F_a falls under allowed value at higher rotation speed there is a danger of skidding of balls between the raceways of the washers because of the centrifugal force. Allowed value F_a is calculated:

$$F_{a \min} = M \left(\frac{n_{\max}}{1000} \right)^2 \quad (\text{kN})$$

- $F_{a \min}$ - minimal axial load
- n_{\max} - limiting rotation speed
- M - minimal load index

If the axial load is lower than $F_{a \min}$ or during the operation the bearing is relieved, e.g. one row of balls in a double direction thrust ball bearing or one bearing in the arrangement of a single direction bearing pair is relieved it is necessary to secure the minimal load, e.g. by means of springs.

SINGLE DIRECTION AND DOUBLE DIRECTION THRUST BALL BEARINGS ZVL SLOVAKIA, a. s.

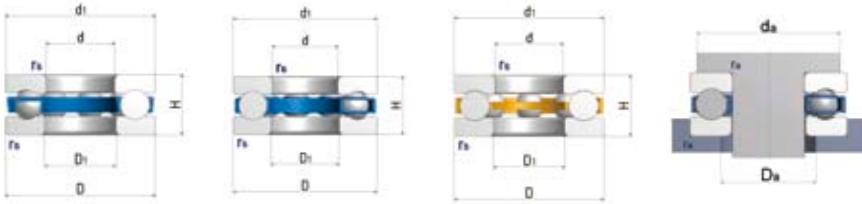

d	DIMENSIONS mm						LIMITING SPEED FOR LUBRICATION min ⁻¹		BASIC LOAD RATING kN		BEARING DESIGNATION	WEIGHT /kg/	MINIMAL AXIAL LOAD INDEX	ABUTMENT AND FILLET DIMENSIONS		
	D	d1	D1	H	rs			C	Co	M				da min.	Da max.	ra max.
10	24	24	11	9	0,3	7900	10600	7,9	10,6	51100	0,02	0,001	19	15	0,3	
	26	26	12	11	0,6	7100	9400	12,6	10,4	51200	0,03	0,002	20	16	0,6	
12	26	26	13	9	0,3	7500	10000	10,4	10,4	51101	0,02	0,002	21	17	0,3	
	28	28	14	11	0,6	6700	8900	13,1	12,3	51201	0,03	0,002	22	18	0,6	
15	28	28	16	9	0,3	7100	9400	10,6	11,9	51102	0,02	0,002	23	20	0,3	
	32	32	17	12	0,6	6000	7900	15,8	16,5	51202	0,03	0,004	25	22	0,6	
17	30	30	18	9	0,3	7100	9400	11,4	14,4	51103	0,03	0,003	25	22	0,3	
	35	35	19	12	0,6	5600	7500	16,2	18,8	51203	0,05	0,004	28	24	0,6	
20	35	35	21	10	0,3	6300	8400	15	19,6	51104	0,04	0,004	29	26	0,3	
	40	40	22	14	0,6	5000	6700	22,4	26,1	51204	0,08	0,008	32	28	0,6	
25	42	42	26	11	0,6	5300	7100	18,1	27,1	51105	0,06	0,006	35	32	0,6	
	47	47	27	15	0,6	4500	6000	27,6	36,2	51205	0,12	0,015	38	34	0,6	
	52	52	27	18	1	3800	5000	35,5	42,2	51305	0,18	0,02	41	36	1	
	60	60	27	24	1	3200	4200	55,6	89,4	51405	0,34	0,035	46	39	1	
30	47	47	32	11	0,6	5000	6700	18,8	31,6	51106	0,07	0,008	40	37	0,6	
	52	52	32	16	0,6	4000	5300	29,3	43,8	51206	0,14	0,018	43	39	0,6	
	60	60	32	21	1	3300	4500	43	55,2	51306	0,27	0,03	48	42	1	
	70	70	32	28	1	2700	3500	72,66	125	51406	0,53	0,085	54	46	1	
35	52	52	37	12	0,6	4700	6300	20	38,3	51107	0,08	0,012	45	42	0,6	
	62	62	27	18	1	3500	4700	39,1	58,4	51207	0,22	0,032	51	46	1	
	68	68	37	24	1	2800	3800	55,4	105	51307	0,39	0,05	55	48	1	
	80	80	37	32	1,1	2200	3000	86,93	155	51407	0,79	0,12	62	53	1	
40	60	60	42	13	0,6	4200	5600	27,1	51,1	51108	0,12	0,018	52	48	0,6	
	68	68	42	19	1	3200	4200	46,9	98,2	51208	0,27	0,047	57	51	1	
	78	78	42	26	1	2700	3500	69,24	135	51308	0,55	0,095	63	55	1	
	90	90	42	36	1,1	2000	2700	112,3	205,3	51408	1,14	0,19	70	60	1	
45	65	65	47	14	0,6	4000	5300	27,6	57,3	51109	0,15	0,025	57	53	0,6	
	73	73	47	20	1	3000	4000	47,75	105	51209	0,32	0,06	62	56	1	
	85	85	47	28	1	2400	3200	79,4	117	51309	0,69	0,13	69	61	1	
	100	100	47	39	1,1	1900	2500	140,7	262,4	51409	1,47	0,35	78	67	1	
50	70	70	52	14	0,6	3800	5000	28,7	63,1	51110	0,16	0,035	62	58	0,6	
	78	78	52	22	1	2800	3800	48,54	112	51210	0,39	0,082	67	61	1	
	95	95	52	31	1,1	2100	2800	96,2	144	51310	1	0,19	77	68	1	
	110	110	52	43	1,5	1700	2200	158	200	51410	1,99	0,45	86	74	1,5	
55	78	78	57	16	0,6	3300	4500	34,8	77,9	51111	0,24	0,04	69	64	0,6	
	90	90	57	25	1	2500	3300	69,4	123	51211	0,61	0,11	76	69	1	
	105	105	57	35	1,1	1900	2500	119,2	246,4	51311	1,34	0,27	85	75	1	
	120	120	57	48	1,5	1600	2100	207	251	51411	2,64	0,65	94	81	1,5	
60	85	85	62	17	1	3200	4200	41,4	94,4	51112	0,29	0,066	75	70	1	
	95	95	62	26	1	2400	3200	73,6	141	51212	0,69	0,13	81	74	1	
	110	110	62	35	1,1	1900	2500	118,14	262	51312	1,43	0,35	90	80	1	
	130	130	62	51	1,5	1400	1900	224	287	51412	3,51	0,9	102	88	1,5	



SINGLE DIRECTION THRUST BALL BEARINGS ZVL SLOVAKIA, a. s.

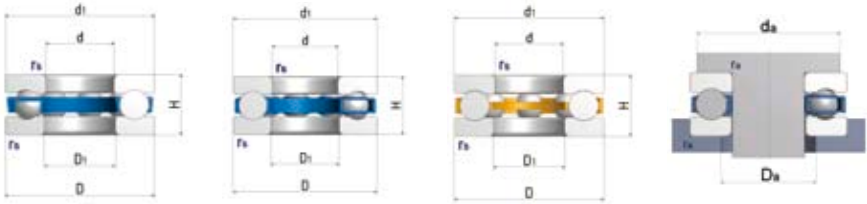

DIMENSIONS mm							LIMITING SPEED FOR LUBRICATION min ⁻¹		BASIC LOAD RATING kN		BEARING DESIGNATION	WEIGHT /kg/	MINIMAL AXIAL LOAD INDEX	ABUTMENT AND FILLET DIMENSIONS		
d	D	d1	D1	H	rs							M	da min.	Da max.	ra max.	
65	90	90	67	18	1	2800	3800	40,57	112	51113	0,34	0,086	80	75	1	
	100	100	67	27	1	2400	3200	75	150	51213	0,77	0,17	86	79	1	
	115	115	67	36	1,1	1800	2400	116,13	262	51313	1,57	0,45	95	85	1	
	140	140	68	56	2	1300	1800	233	329	51413	4,47	1,3	110	95	2	
70	95	95	75	18	1	2800	3800	40,92	115	51114	0,36	0,11	85	80	1	
	100	100	72	27	1	2200	3000	73,59	188	51214	0,81	0,21	91	84	1	
	125	125	72	40	1,1	1700	2200	148,31	340	51314	2,06	0,54	103	92	1	
75	100	100	77	19	1	2700	3500	48,26	140	51115	0,42	0,12	90	85	1	
	110	110	77	27	1	2200	3000	74,9	198	51215	0,86	0,27	96	89	1	
	135	135	77	44	1,5	1600	2100	163,39	380	51315	2,68	0,76	111	99	1,5	
	160	160	78	65	2	1000	1300	299	438	51415	6,75	2,1	126	109	2	
80	105	105	82	19	1	2700	3500	48,74	145	51116	0,43	0,15	95	90	1	
	115	115	82	28	1	2000	2700	83,75	222	51216	0,95	0,35	101	94	1	
	140	140	82	44	1,5	1500	2000	181	316	51316	2,82	0,85	116	104	1,5	
	170	170	83	68	2,1	890	1200	316	482	51416	7,97	2,7	133	117	2	
85	110	110	87	19	1	2700	3500	49,21	150	51117	0,46	0,18	100	95	1	
	125	125	88	31	1	1900	2700	103,4	280	51217	1,29	0,43	109	101	1	
	150	150	88	49	1,5	1300	1800	209,06	495	51317	3,66	1,2	123	111	1,5	
	180	177	88	72	2,1	890	1200	335	531	51417	9,45	3,3	141	124	2	
90	120	120	92	22	1	2200	3000	65,09	208,1	51118	0,46	0,18	108	102	1	
	135	135	93	35	1,1	1700	2200	133	282	51218	1,77	0,53	117	108	1	
	155	155	93	50	1,5	1100	1500	232,5	556,4	51318	3,88	1,5	129	116	1,5	
	190	187	93	77	2,1	790	1060	383	619	51418	11,2	4,1	149	131	2	
100	135	135	102	25	1	2000	2700	85,8	228	51120	0,99	0,34	121	114	1	
	150	150	103	38	1,1	1600	2100	162	348	51220	2,36	0,77	130	120	1	
	170	170	103	55	1,5	1060	1400	251	464	51320	5,11	2	142	128	1,5	
	210	205	103	85	3	750	1000	447	779	51420	15	6,2	165	145	2,5	
110	145	145	112	25	1	1900	2500	87,4	251	51122	1,08	0,42	131	124	1	
	160	160	113	38	1,1	1300	1800	171	391	51222	2,57	1,1	140	130	1	
	190	187	113	63	2	890	1200	304	584	51322	7,87	2,8	158	142	2	
	230	225	113	95	3	670	890	492	909	51422	20,2	9	181	159	2,5	
120	155	155	122	25	1	1600	2100	89,1	271	51124	1,16	0,53	141	134	1	
	170	170	123	39	1,1	1200	1600	174	422	51224	2,86	1,4	150	14	1	
	210	205	123	70	2,1	790	1060	348	708	51324	10,9	4,1	173	157	2	
	250	245	123	102	4	630	840	531	1040	51424	25,5	13	197	173	3	
130	170	170	132	30	1	1400	1900	119	355	51126	1,87	0,65	154	146	1	
	170	170	132	30	1	1400	1900	85	316	51126M	1,9	0,65	154	146	1	
	190	187	133	45	1,5	1100	1500	237	562	51226	4,19	1,7	166	154	1,5	
	225	220	134	75	2,1	750	1000	369	779	51326	13,3	6,2	186	169	2	
	270	265	134	110	4	560	750	631	1280	51426	32	18	213	187	3	

SINGLE DIRECTION THRUST BALL BEARINGS ZVL SLOVAKIA, a. s.

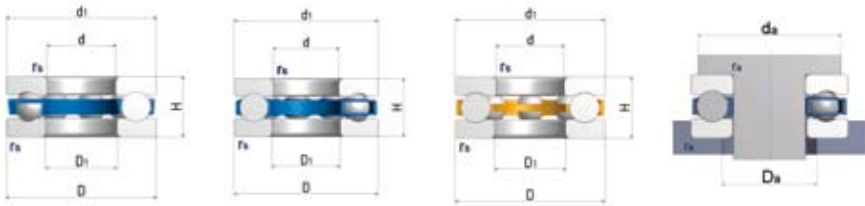

d	DIMENSIONS mm					LIMITING SPEED FOR LUBRICATION min ⁻¹		BASIC LOAD RATING kN		BEARING DESIGNATION	WEIGHT /kg/	MINIMAL AXIAL LOAD INDEX	ABUTMENT AND FILLET DIMENSIONS		
	D	d1	D1	H	rs								M	da min.	Da max.
140	180	178	142	31	1	1300	1800	121	369	51128	2,07	0,8	164	156	1
	200	197	143	46	1,5	1060	1400	242	596	51228	4,88	2	176	164	1,5
	240	235	144	80	2,1	710	940	414	962	51328	15,9	8	199	181	2
	280	275	144	112	4	670	890	631	1310	51428	34,5	19	223	197	3
150	190	188	152	31	1	1300	1800	123	398	51130	2,2	0,95	174	166	1
	200	212	153	50	1,5	1000	1300	271	681	51230	6,19	2,8	189	176	1,5
	250	245	154	80	2,1	710	940	430	1020	51330	16,7	10	209	191	2
	300	295	154	120	4	500	670	668	1470	51430	42,3	28	239	211	3
160	200	200	162	31	1	1300	1800	126	422	51132	2,33	1,2	184	176	1
	200	200	162	31	1	1300	1800	85	395	51132M	2,33	1,2	184	176	1
	225	225	163	51	1,5	890	1200	158	511	51232	6,67	3,2	199	186	1,5
	225	225	163	51	1,5	890	1200	205	692	51232M	6,67	3,2	199	186	1,5
170	215	213	172	34	1,1	1200	1600	158	511	51134	3,31	1,5	197	188	1
	215	213	172	34	1,1	1200	1600	101	443	51134M	3,31	1,5	197	188	1
	240	237	173	55	1,5	840	1100	282	750	51234	8,28	4,6	212	198	1,5
	240	237	173	55	1,5	840	1100	216	744	51234M	8,28	4,6	212	198	1,5
180	225	222	182	34	1,1	1100	1500	165	562	51136	3,48	1,9	207	198	1
	225	222	182	34	1,1	1100	1500	116	500	51136M	3,48	1,9	207	198	1
	250	247	183	56	1,5	840	1100	304	858	51236	8,85	5,5	222	208	1,5
190	240	237	193	37	1,1	1060	1400	185	631	51138	4,06	2,4	220	210	1
	270	267	194	62	2,1	750	1000	355	1020	51238	11,9	7,5	238	222	2
200	250	247	203	37	1,1	1060	1400	188	656	51140	4,24	3,1	230	220	1
	280	277	204	62	2,1	750	1000	355	1020	51240	12,4	9,5	248	232	2
	340	335	205	110	5	480	630	480	1930	51340	43,5	29	283	257	3
220	270	267	223	37	1,1	1000	2000	143	680	51144	4,62	4,6	250	240	1
	300	297	224	63	2,1	710	940	369	1140	51244	13,7	14	268	252	2
240	300	297	243	45	1,5	840	1100	261	926	51148	7,55	6,5	276	264	1,5
	340	335	244	78	2,1	600	790	482	1580	51248	23,6	19	299	281	2
260	320	317	263	45	1,5	840	1100	266	1000	51152	8,11	8,6	296	284	1,5
	360	355	264	79	3,5	560	750	340	1530	51252	25,5	22	319	301	2
280	350	347	283	53	1,5	750	1000	335	1280	51156	12,2	11	322	308	1,5
	380	375	284	80	2,1	700	950	345	1600	51256	27,5	30	339	321	2
300	380	396	304	62	2,1	630	850	285	1340	51160	17,5	14	348	332	2
	420	415	304	95	3	500	670	584	2240	51260	43,1	40	371	348	2,5
320	400	396	324	63	2,1	630	840	414	1650	51164	18,9	16	368	352	2
	440	435	325	95	3	470	630	619	2460	51264	45,5	48	392	368	2,5
340	420	416	344	64	2,1	600	790	406	1780	51168	20,3	19	388	372	2
	440	435	324	95	4	450	600	455	2320	51268	45,5	53	411	389	2,5



SINGLE DIRECTION THRUST BALL BEARINGS ZVL SLOVAKIA, a. s.

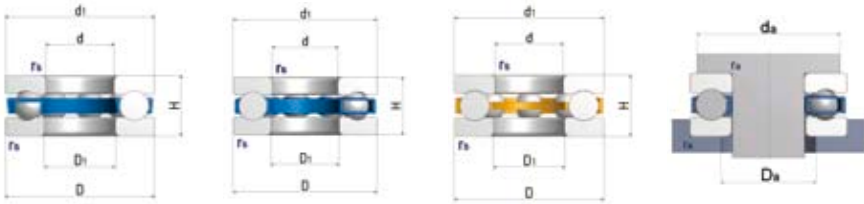

DIMENSIONS mm							LIMITING SPEED FOR LUBRICATION min ⁻¹		BASIC LOAD RATING kN		BEARING DESIGNATION	WEIGHT /kg/	MINIMAL AXIAL LOAD INDEX	ABUTMENT AND FILLET DIMENSIONS		
d	D	d1	D1	H	rs							M	da min.	Da max.	ra max.	
360	440	436	364	65	2,1	560	750	414	1880	51172	21,8	22	408	392	2	
	500	495	365	110	5	400	530	570	3100	51272	70	69	443	417	3	
380	460	456	384	65	2,1	560	750	430	2240	51176	23	22	428	412	2	
	520	515	385	112	5	380	500	570	3200	51276	73	81	463	437	3	
400	480	476	404	65	2,1	530	710	439	2150	51180	24,6	28	448	432	2	
420	500	496	424	65	2,1	530	710	447	2240	51184	25,1	30	470	450	2	
440	540	536	444	80	2,1	450	600	530	3000	51188	40,3	48	499	481	2	
460	540	535	444	80	2,1	430	560	530	3100	51192	42	50	519	501	2	
480	580	575	484	80	2,1	400	530	540	3250	51196	43,5	53	539	521	2	
500	600	596	504	80	3	430	560	425	2700	511/500	47	59	1110	1070	4	
530	640	636	534	85	4	400	530	500	3250	511/530	58,5	59,5	595	575	2,5	

DOUBLE DIRECTION THRUST BALL BEARINGS ZVL SLOVAKIA, a. s.

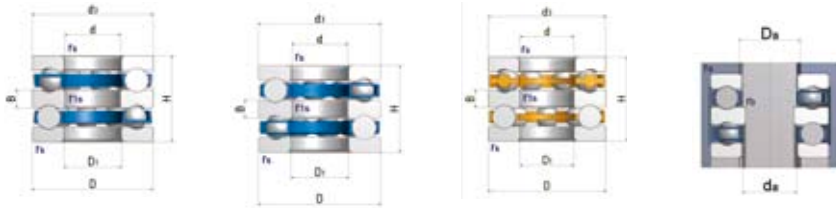

DIMENSIONS mm									LIMITING SPEED FOR LUBRICATION min ⁻¹		BASIC LOAD RATING kN		BEARING DESIGNATION	WEIGHT /kg/	MINIMAL AXIAL LOAD INDEX	ABUTMENT AND FILLET DIMENSIONS		
d	D	d3	D1	H	B	rs	r1s							M	Da	da	ra	
10	32	32	17	22	5	0,6	0,3	6000	7900	15,7	24,3	52202	0,08	0,004	15	22	0,6	
15	40	40	22	26	8	0,6	0,3	5000	6700	22,4	26,1	52204	0,15	0,008	20	28	0,6	
	60	60	27	45	11	1	0,6	3200	4600	55,2	55,2	52405	0,63	0,035	25	39	1	
20	47	47	27	28	7	0,6	0,3	4500	6000	27,6	36,2	52205	0,23	0,015	25	34	0,6	
	52	52	27	34	8	1	0,3	3800	5000	35,5	42,2	52305	0,33	0,02	25	36	1	
25	70	70	32	52	12	1	0,6	2700	3500	72,1	81	52406	1	0,085	30	46	1	
	52	52	32	29	7	0,6	0,3	4000	5300	29,3	43,8	52206	0,27	0,018	30	39	0,6	
30	60	60	32	38	9	1	0,3	3300	4500	43	55,2	52306	0,49	0,03	30	42	1	
	80	80	37	59	14	1,1	0,6	2200	3000	87,4	100	52407	1,44	0,12	35	53	1	
35	62	62	37	34	8	1	0,3	3500	4700	39,1	58,4	52207	0,42	0,032	35	46	1	
	68	68	37	44	10	1	0,3	2800	3800	55,2	73,6	52307	0,71	0,05	35	48	1	
40	68	68	42	36	9	1	0,6	3200	4200	43,8	70,8	52208	0,54	0,047	40	51	1	
	78	78	74	49	12	1	0,6	2700	3500	69,4	94,4	52308	1,06	0,095	40	55	1	
45	90	90	42	65	15	1,1	0,6	2000	2700	112	204	52408	1,92	0,12	40	60	1	
	73	73	47	37	9	1	0,6	3000	4000	46,4	81	52209	0,62	0,06	45	56	1	
50	85	85	47	52	12	1	0,6	2400	3200	79,4	117	52309	1,29	0,13	45	61	1	
	100	100	47	72	17	1,1	0,6	1900	2500	131	158	52409	2,71	0,35	45	67	1	
55	78	78	52	39	9	1	0,6	2800	3800	42,7	100,6	52210	0,71	0,082	50	61	1	
	95	95	52	58	14	1,1	0,6	2100	2800	73,5	144	52310	1,86	0,19	50	68	1	
60	90	90	57	45	10	1	0,6	2500	3300	69,4	123	52211	1,12	0,11	55	69	1	
	105	105	57	64	15	1,1	0,6	1900	2500	91,5	174	52311	2,51	0,27	55	75	1	
65	120	120	57	87	20	1,5	0,6	1600	2100	156	251	52411	4,7	0,65	55	81	1	
	95	95	62	46	10	1	0,6	2400	3200	56	141	52212	1,25	0,13	60	74	1	
70	110	110	62	64	15	1,1	0,6	1900	2500	95	192	52312	2,68	0,35	60	80	1	
	1230	130	62	93	21	1,5	0,6	1400	1900	170	287	52412	6,33	0,9	60	88	1,5	
75	100	100	67	47	10	1	0,6	2400	3200	75	150	52213	1,36	0,17	65	79	1	
	115	115	67	65	15	1,1	0,6	1800	2400	128	211	52313	2,9	0,45	65	85	1	
80	105	105	72	47	10	1	1	2200	3000	76,4	162	52214	1,48	0,21	70	84	1	
	125	125	72	72	16	1,1	1	1700	2200	147	251	52314	3,9	0,54	70	92	1	
85	110	110	77	47	10	1	1	2200	3000	77,9	171	52215	1,57	0,27	75	89	1	
	135	135	77	79	18	1,5	1	1600	2100	185	310	52315	4,83	0,76	75	99	1,5	
90	115	115	82	48	10	1	1	2000	2700	79,4	181	52216	1,69	0,35	80	95	1	
	140	140	82	79	18	1,5	1	1500	2000	181	316	52316	5,06	0,85	80	104	1,5	
95	125	125	88	55	12	1	1	1900	2500	96,2	215	52217	2,34	0,43	85	101	1	
	150	150	88	87	19	1,5	1	1300	1800	224	376	52317	6,43	1,2	85	111	1,5	
100	135	135	93	62	14	1,1	1	1700	2200	133	282	52218	3,22	0,53	90	108	1	
	155	155	93	88	19	1,5	1	1100	1500	233	406	52318	6,6	1,5	90	116	1,5	
105	150	150	103	67	15	1,1	1	1600	2100	162	348	52220	4,29	0,77	100	120	1	
	170	170	103	97	21	1,5	1	1060	1400	251	464	52320	8,9	2	100	128	1,5	
110	160	160	113	67	15	1,1	1	1300	1800	171	391	52222	4,68	1,1	110	130	1	
	170	170	123	68	15	1,1	1,1	1200	1600	174	422	52224	5,24	1,4	120	140	1	
115	210	209,5	123	123	27	2,1	1,1	790	1060	348	708	52324	17,2	4,1	120	157	2	
	190	189,5	133	80	18	1,5	1,1	1100	1500	237	562	52226	7,74	1,7	130	154	1,5	
120	200	199,5	143	81	18	1,5	1,1	1060	1400	242	596	52228	8,95	2	140	164	1,5	
	215	214,5	153	89	20	1,5	1,1	1000	1300	271	681	52230	10,6	2,8	150	176	1,5	
130	250	249,5	154	140	31	3	2,1	670	900	455	980	52330	27	7,8	150	191	2	
	140	225	224,5	163	90	20	1,5	1,1	890	1200	276	722	52232	12,2	3,2	160	186	1,5
150	240	239,5	173	97	21	3	2,1	800	1100	208	720	52234	15	4,2	170	198	1,5	





CYLINDRICAL ROLLER THRUST BEARINGS



CYLINDRICAL ROLLER THRUST BEARINGS

Cylindrical roller thrust bearings are suitable for arrangements that are stiff and can carry high loads, they are resistant to shock loads.

Cylindrical roller thrust bearings have simple component shapes, what make them easy to use in various combinations, with or without bearings rings or by creating a raceway in the connecting components.

Cylindrical roller thrust bearings are used in arrangements, where other thrust bearings designs have insufficient load carrying capacity. Cylindrical roller thrust bearings can carry axial load only.



DESIGN SPECIFICATION

MAIN DIMENSIONS

Cylindrical roller thrust bearings main dimensions specified in the dimension tables are in accordance with the international standard ISO 104.

Structure

Cylindrical roller thrust bearings series 811 and 812 have usually three parts - cylindrical roller thrust cage, shaft washer (WS) and housing washer (GS). The most important part is a bearing cage (K811, K812). If the front surfaces of connecting components are produced in sufficient tolerance, it is possible to use them as raceways and to use only cylindrical roller thrust cage for acting forces transmission. A significant saving of the housing area is possible in this arrangement.

TOLERANCE

Cylindrical roller thrust bearings are produced as standard in tolerance class P0. Production of bearings with higher tolerance should be discussed in advance. The dimension tolerances are in accordance with the international standards and are stated in the table part of this catalogue.

DESIGN OF BEARING ASSOCIATED COMPONENTS

The support surfaces in the housing and on the shaft provide support for the bearing washers across the whole extent and width of the raceways. Hardness of housing and shaft raceways for thrust bearing cages without washers should be 58-64 HRC. Dimension and shape tolerance of raceways has to comply with the figures in table part of this catalogue dedicated to thrust bearings rings (tab 20).

CAGE

Cylindrical roller thrust bearing cages are produced of glass fiber reinforced polyamide 6.6 (designation TNG) or brass (without designation). Specific design for individual part numbers is specified in table part.

EQUIVALENT DYNAMIC LOAD

$$P = Fa$$

EQUIVALENT STATIC LOAD

If static load is applied to the cylindrical bearing, then:

$$Pp = Fa$$

LIMITING SPEED

The limiting speed specified in this catalogue represents the maximum number of revolutions acceptable for bearing to be able to operate trouble-free at certain safety level.



CYLINDRICAL ROLLER THRUST BEARINGS ZVL SLOVAKIA, a. s.

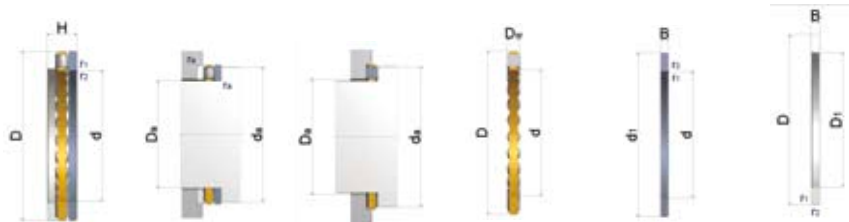

DIMENSIONS mm					BASIC LOAD RATING kN		LIMITING SPEED FOR LUBRICATION min ⁻¹		BEARING DESIGNATION	WEIGHT kg	BEARING COMPONENT DESIGNATION			ABUTMENT AND FILLET DIMENSIONS					
d	D	B	r1 min	r2 min	C	Co				CAGE WITH ROLLERS	SHAFT WASHER	HOUSING WASHER	D1	Dw	H	da min	Da max	ra max	
15	28	9	0,3	0,3	14,4	28,5	8200	11000	81102	0,024	K81102TNG	WS81102	GS81102	16	3,5	2,75	27	16	0,3
17	30	9	0,3	0,3	15,9	33,5	7500	10000	81103	0,027	K81103TNG	WS81103	GS81103	18	3,5	2,75	29	18	0,3
20	35	10	0,3	0,3	24,9	53	6300	8500	81104	0,037	K81104TNG	WS81104	GS81104	21	4,5	2,75	34	21	0,3
25	42	11	0,6	0,6	33,5	76	5200	7000	81105	0,053	K81105TNG	WS81105	GS81105	26	5	3	41	26	0,6
30	47	11	0,6	0,6	35,5	86	4500	6000	81106	0,057	K81106TNG	WS81106	GS81106	32	5	3	46	31	0,6
	52	16	0,6	0,6	64	141	3900	5200	81206	0,123	K81206TNG	WS81206	GS81206	32	7,5	4,25	50	31	0,6
35	52	12	0,6	0,6	39	101	4100	5500	81107	0,073	K81107TNG	WS81107	GS81107	37	5	3,5	51	36	0,6
	62	18	1	1	80	199	3300	4400	81207	0,195	K81207TNG	WS81207	GS81207	37	7,5	5,25	58	39	1
40	60	13	0,6	0,6	56	148	3600	4800	81108	0,105	K81108TNG	WS81108	GS81108	42	6	3,5	58	42	0,6
	68	19	1	1	107	265	3000	4000	81208	0,249	K81208TNG	WS81208	GS81208	42	9	5	66	43	1
45	65	14	0,6	0,6	59	163	3300	4400	81109	0,13	K81109TNG	WS81109	GS81109	47	6	4	63	47	0,6
	73	20	1	1	105	265	2800	3700	81209	0,287	K81209TNG	WS81209	GS81209	47	9	5,5	70	48	1
50	70	14	0,6	0,6	61	177	3000	4000	81110	0,14	K81110TNG	WS81110	GS81110	52	6	4	68	52	0,6
	78	22	1	1	117	315	2500	3400	81210	0,356	K81210TNG	WS81210	GS81210	52	9	6,5	75	53	1
55	78	16	0,6	0,6	90	300	2700	3600	81111	0,218	K81111TNG	WS81111	GS81111	57	6	5	77	57	0,6
	90	25	1	1	154	405	2300	3000	81211	0,568	K81211TNG	WS81211	GS81211	57	11	7	85	59	1
60	85	17	1	1	103	315	2500	3300	81112	0,266	K81112TNG	WS81112	GS81112	62	7,5	4,75	82	62	1
	95	26	1	1	172	480	1900	2600	81212	0,642	K81212TNG	WS81212	GS81212	62	11	7,5	91	64	1
65	90	18	1	1	107	340	2300	3100	81113	0,31	K81113TNG	WS81113	GS81113	67	7,5	5,25	87	67	1
	100	27	1	1	177	500	1750	2300	81213	0,721	K81213TNG	WS81213	GS81213	67	11	8	96	69	1
70	95	18	1	1	111	365	2100	2900	81114	0,332	K81114TNG	WS81114	GS81114	72	7,5	5,25	92	72	1
	105	27	1	1	187	550	1500	2000	81214	0,768	K81214TNG	WS81214	GS81214	72	11	8	102	74	1
75	100	19	1	1	107	350	2000	2700	81115	0,393	K81115TNG	WS81115	GS81115	77	7,5	5,75	97	78	1
	110	27	1	1	172	500	1350	1800	81215	0,8	K81215TNG	WS81215	GS81215	77	11	8	106	79	1
80	105	19	1	1	106	350	1900	2600	81116	0,4	K81116TNG	WS81116	GS81116	82	7,5	5,75	102	83	1
	115	28	1	1	201	630	1200	1600	81216	0,9	K81216TNG	WS81216	GS81216	82	11	8,5	112	84	1
85	110	19	1	1	112	385	1800	2500	81117	0,42	K81117TNG	WS81117	GS81117	87	7,5	5,75	108	87	1
	125	31	1	1	217	660	1100	1400	81217	1,26	K81217TNG	WS81217	GS81217	88	12	9,5	119	90	1
90	120	22	1	1	141	465	1700	2300	81118	0,62	K81118TNG	WS81118	GS81118	92	9	6,5	117	93	1
	135	35	1,1	1,1	290	890	950	1300	81218	1,77	K81218TNG	WS81218	GS81218	93	14	10,5	129	95	1
100	135	25	1	1	199	650	1500	2000	81120	0,95	K81120TNG	WS81120	GS81120	102	11	7	131	104	1
	150	38	1,1	1,1	340	1080	850	1100	81220	2,2	K81220TNG	WS81220	GS81220	103	15	11,5	142	107	1



CYLINDRICAL ROLLER THRUST BEARINGS ZVL SLOVAKIA, a. s.

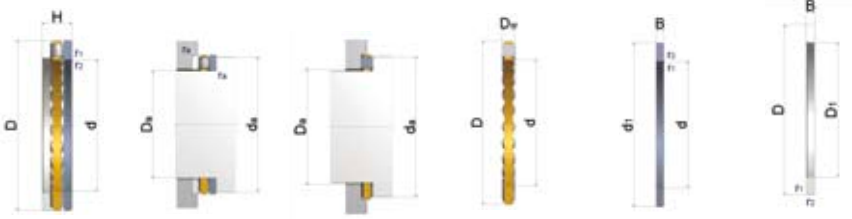

d	DIMENSIONS mm					BASIC LOAD RATING kN		LIMITING SPEED FOR LUBRICATION min ⁻¹		BEARING DESIGNATION	WEIGHT kg	BEARING COMPONENT DESIGNATION			ABUTMENT AND FILLET DIMENSIONS				
	D	B	r1 min	r2 min	C	Co	C	Co	CAGE WITH ROLLERS			SHAFT WASHER	HOUSING WASHER	D1	Dw	H	da min	Da max	ra max
110	145	25	1	1	207	700	1400	1900	81122	1,04	K81122TNG	WS81122	GS81122	112	11	7	141	114	1
	160	38	1,1	1,1	325	1030	670	900	81222	2,29	K81222TNG	WS81222	GS81222	113	15	11,5	152	117	1
120	155	25	1,1	1,1	125	520	750	1000	81124	1,23	K81124	WS81124	GS81124	155	10	7	126	149	1
	170	39	1,1	1,1	245	965	600	800	81224	2,7	K81224	WS81224	GS81224	123	15	12	162	127	1
130	170	30	1	1	229	923	680	920	81126	1,83	k81126	ws81126	GS81126	170	12	8	133	169	1
	190	45	1,5	1,5	335	1250	530	700	81226	4,2	K81226	WS81226	GS81226	133	19	13	181	137	1,5
140	180	31	1	1	193	850	670	900	81128	1,95	K81128	WS81128	GS81128	142	12	9,5	175	145	1
	200	46	1,5	1,5	360	1400	530	700	81228	4,55	K81228	WS81228	GS81228	143	19	13,5	191	147	1,5
150	190	31	1	1	200	900	630	850	81130	2,05	K81130	WS81130	GS81130	152	12	9,5	185	155	1
	215	50	1,5	1,5	465	1900	480	630	81230	5,9	K81230	WS81230	GS81230	153	21	14,5	211	158	1,5
160	200	31	1	1	204	965	630	850	81132	2,2	K81132	WS81132	GS81132	162	12	9,5	195	165	1
	225	51	1,5	1,5	480	2000	450	600	81232	6,2	K81232	WS81232	GS81232	163	21	15	220	168	1,5
170	215	34	1,1	1,1	260	1180	600	800	81134	2,95	K81134	WS81134	GS81134	172	14	10	209	176	1
	240	55	1,5	1,5	540	2280	430	560	81234	7,7	K81234	WS81234	GS81234	173	22	16,5	235	180	1,5
180	225	34	1,1	1,1	270	1270	560	750	81136	3,05	K81136	WS81136	GS81136	183	14	10	219	185	1
	250	56	1,5	1,5	550	2400	430	560	81236	8,25	K81236	WS81236	GS81236	183	22	17	245	190	1,5
190	240	37	1,1	1,1	310	1460	530	700	81138	3,85	K81138	WS81138	GS81138	193	15	11	233	197	1
	270	62	2	2	695	2900	380	500	81238	10,5	K81238	WS81238	GS81238	194	26	18	265	200	2
200	250	37	1,1	1,1	310	1500	530	700	81140	4	K81140	WS81140	GS81140	203	15	11	243	206	1
	280	62	2	2	700	3100	380	500	81240	12	K81240	WS81240	GS81240	204	26	18	275	210	2
220	270	37	1,1	1,1	335	1700	500	670	81144	4,5	K81144	WS81144	GS81144	223	15	11	263	226	1
	300	63	2	2	750	3350	360	480	81244	13	K81244	WS81244	GS81244	224	26	18,5	296	230	2
240	300	45	1,5	1,5	475	2450	430	560	81148	7,25	K81148	WS81148	GS81148	243	18	13,5	296	248	1,5
	340	78	2,1	2,1	1100	4900	280	380	81248	22	K81248	WS81248	GS81248	244	32	23	335	261	2
260	320	45	1,5	1,5	490	2600	400	530	81152	7,85	K81152	WS81152	GS81152	263	18	13,5	316	268	1,5
	360	79	2,1	2,1	1140	5300	280	380	81252	24	K81252	WS81252	GS81252	264	32	23,5	353	280	2
280	350	53	1,5	1,5	680	3550	360	480	81156	10,5	K81156	WS81156	GS81156	283	22	15,5	346	288	1,5
	380	80	2,1	2,1	1160	5500	260	360	81256	26	K81256	WS81256	GS81256	284	32	24	373	300	2
300	380	62	2	2	850	4400	320	430	81160	16,5	K81160	WS91160	GS81160	304	25	18,5	373	315	2
	420	95	3	3	1530	7200	220	320	81260	40,5	K81260	WS81260	GS81260	304	38	28,5	413	328	2,5
320	400	63	2	2	880	4650	300	400	81164	18	K81164	WS81164	GS81164	324	25	19	394	334	2
	440	95	3	3	1560	7500	200	300	81264	42,5	K81264	WS81264	GS81264	325	38	28,5	434	348	2,5
340	420	64	2	2	900	4900	280	380	81168	19,5	K81168	WS81168	GS81168	344	25	19,5	414	354	2
	460	96	3	3	1630	8000	200	300	81268	47	K81268	WS81268	GS81268	345	38	29	452	367	2,5

CYLINDRICAL ROLLER THRUST BEARINGS ZVL SLOVAKIA, a. s.

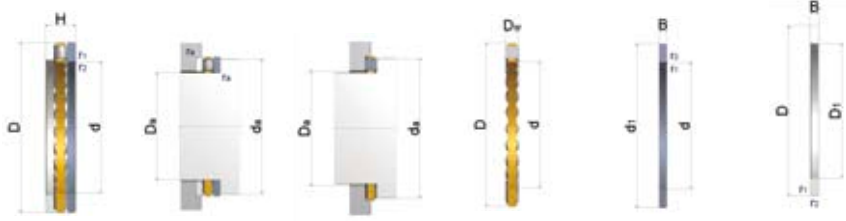

DIMENSIONS mm				BASIC LOAD RATING kN		LIMITING SPEED FOR LUBRICATION min ⁻¹		BEARING DESIGNATION		WEIGHT kg	BEARING COMPONENT DESIGNATION			ABUTMENT AND FILLET DIMENSIONS					
d	D	B	r1 min	r2 min	C	Co					CAGE WITH ROLLERS	SHAFT WASHER	HOUSING WASHER	D1	Dw	H	da min	Da max	ra max
360	440	65	2	2	915	5000	280	380	81172	19,5	K81172	WS81172	GS81172	364	25	20	434	374	2
	500	110	4	4	2160	10400	163	212	81272	65,5	K81272	WS81272	GS81272	365	45	32,5	492	393	3
380	460	65	2	2	930	5300	260	360	81176	22	K81176	WS81176	GS81176	384	25	20	453	393	2
	520	112	4	4	2200	10800	160	210	81276	70	K81276	WS81276	GS81276	385	45	33,5	511	413	3
400	480	65	2	2	965	5600	260	360	81180	23	K81180	WS81180	GS81180	404	25	20	473	413	2
	540	112	4	4	2240	11200	160	210	81280	73	K81280	WS81280	GS81280	405	45	33,5	531	433	3
420	500	65	2	2	980	5850	240	340	81184	24	K81184	WS81184	GS81184	424	25	20	493	433	2
	580	130	5	5	2850	14000	155	205	81284	95,5	K81284	WS81284	GS81284	425	52	39	571	459	4
440	540	80	2,1	2,1	1430	8000	200	300	81188	39,5	K81188	WS81188	GS81188	444	32	24	533	459	2
	600	130	5	5	2900	14600	155	205	81288	110	K81288	WS81288	GS81288	445	52	39	591	479	4
460	560	80	2,1	2,1	1460	8500	200	300	81192	41	K81192	WS81192	GS81192	464	32	24	553	479	2
	620	130	5	5	2700	13400	150	200	81292	118	K81292	WS81292	GS81292	465	52	39	611	499	4
480	580	80	2,1	2,1	1460	8650	190	280	81196	43	K81196	WS81196	GS81196	484	32	24	573	500	2
	650	135	5	5	3350	17000	145	195	81296	128	K81296	WS81296	GS81296	485	56	39,5	641	520	4
500	600	80	2,1	2,1	1530	9150	190	280	811/500	44	K811/500	WS811/500	GS811/500	505	32	24	592	519	2
	670	135	5	5	3400	17600	140	190	812/500	133	K812/500	WS812/500	GS812/500	505	56	39,5	661	540	4
530	640	85	3	3	1700	10400	180	260	811/530	55,5	K811/530	WS811/530	GS811/530	535	34	25,5	632	554	2,5
	710	140	5	5	3650	18600	130	180	812/530	154	K812/530	WS812/530	GS812/530	535	60	40	701	572	4
560	670	85	3	3	1760	10800	180	260	811/560	58	K811/560	WS811/560	GS811/560	565	34	25,5	662	584	2,5
	750	150	5	5	3800	20000	120	170	812/560	187	K812/560	WS812/560	GS812/560	565	60	45	741	611	4
600	710	85	3	3	1750	11200	170	240	811/600	62	K811/600	WS811/600	GS811/600	605	34	25,5	702	624	2,5
	800	160	5	5	4400	24000	100	150	812/600	240	K812/600	WS812/600	GS812/600	605	64	48	789	651	4
630	750	95	3	3	2160	13700	160	220	811/630	80	K811/630	WS811/630	GS811/630	634	38	29,5	732	650	2,5





SPHERICAL ROLLER THRUST BEARINGS



SPHERICAL ROLLER THRUST BEARINGS

Spherical roller thrust bearings are able to carry high axial load. Because of their construction with spherical raceways and transmission of load at a certain angle they can carry radial load as well. They are dismountable which allows simpler installation of individual rings into the arrangement.

Design of the individual parts of the spherical roller thrust bearings allows in operation certain mutual misalignment of the rings against each other. In this way the spherical roller thrust bearings are able to eliminate certain deflection of the connecting parts.

Spherical roller thrust bearings have a great number of asymmetrical spherical rollers with a good conformity to the raceway and therefore they are able to carry high axial load.

Spherical roller thrust bearings can be applied in arrangements with high demands for load forces transfer, e.g. shaping machines, cranes, ship's shaft, mining machines, etc.



DESIGN SPECIFICATION

MAIN DIMENSIONS

The main dimensions of double row spherical roller bearings specified in the dimension tables are in accordance with the international standards ISO 104.

DESIGN

Spherical roller thrust bearings are commonly manufactured with brass cage guided by a sleeve held in the shaft washer bore. Designation of these bearings is "MC" Another manufactured design is spherical roller thrust bearing with pressed window-type steel cage. Their designation is "EJ".

TOLERANCE

Spherical roller thrust bearings are produced in standard P0 tolerance class. Production of bearings with a higher tolerance class should be discussed with the manufacturer in advance.

INFLUENCE OF THE OPERATING TEMPERATURE

Spherical roller thrust bearings undergo special heat treatment, which enables their application at high temperatures up to 200 °C without any change of dimensions.

MISALIGNMENT

Because of their design spherical roller thrust bearings allow mutual misalignment, i.e. at common operating conditions ($P_a \leq 0,1 C_a$) they are able to accommodate the misalignment of the shaft and housing without affecting their correct function. Permitted misalignment is stated in the table:

PERMITTED MISALIGNMENT	BEARING TYPE
2°	292XX
2°30'	293XX
3°	294XX

EQUIVALENT DYNAMIC LOAD

In dependence on the influence of the bearing arrangements run-outs and its elimination by the mutual movement of the rings and if $Fr \leq 0,55F$ then:

$P_{ea} = F_a + 1,2 \cdot Fr$ - When run-outs in the bearing arrangement affect the load distribution in the bearing

$P_{ea} = 0,88 \cdot (F_a + 1,2 \cdot Fr)$ - When run-outs in the bearing arrangement do not affect the load distribution in the bearing

where

P_{ea} - equivalent dynamic load of the bearing [N]
 F_r - radial load of the bearing [N]
 F_a - axial load of the bearing [N]

If $F_r \geq 0,55 F_a$, the ZVL SLOVAKIA engineering department should be contacted.

EQUIVALENT STATIC LOAD

Axial load is, if $F_r \leq 0,55 F_a$:

$$P_{oea} = F_a + 2,7 \cdot F_r$$

where

P_{oea} - equivalent static load of the bearing [N]

F_r - radial load of the bearing [N]

F_a - axial load of the bearing [N]

If $F_r \leq 0,55 F_a$, the ZVL SLOVAKIA engineering department should be contacted.

MINIMUM AXIAL LOAD

During the operation of spherical roller thrust bearing there is a danger of rolling element sliding between the raceways of the rings as a result of centrifugal forces and friction in the lubricant and therefore resulting into rolling elements damage or damage of the raceways. Therefore a minimum axial load must be applied on the bearing. The minimum axial load to be applied to spherical roller thrust bearings can be estimated as follows:

$$F_a \min = 1,8 \cdot F_r + M \cdot (n_{\max}/1000)^2$$

If $1,8 F_r < 0,0005 C_0$ then $0,0005 C_0$ should be used in the above equation instead of $1,8 F_r$.

where

$F_a \min$ = minimum axial load

F_r = radial component of the load for bearings subjected to combined load

C_0 = basic static load rating

n_{\max} = maximum rotational speed





M = minimum load coefficient (see tables)

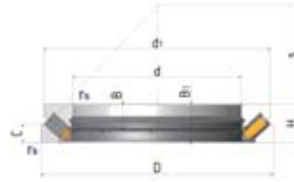

SPHERICAL ROLLER THRUST BEARINGS ZVL SLOVAKIA, a. s.







MC

DIMENSIONS mm				BASIC LOAD RATING kN		LIMITING SPEED FOR LUBRICATION min ⁻¹	BEARING DESIGNATION	WEIGHT kg	ABUTMENT AND FILLET DIMENSIONS		
d	D	B	rs min	 C	 Co		WITH CYLINDRICAL BORE		da min	Da max	ra max
60	130	42	1,5	390	910	2400	29412EJ	2,6	90	107	1,5
65	140	45	2	455	1080	2200	29413EJ	3,3	100	117	2
70	150	48	2	520	1250	2000	29414EJ	4	105	125	2
75	160	51	2	600	1430	2000	29415EJ	4,9	115	133	2
80	170	54	2,1	670	1630	1900	29416EJ	5,8	120	141	2
85	180	58	2,1	735	1800	1800	29417EJ	6,9	130	151	2
90	190	60	2,1	815	2000	1700	29418EJ	8,1	135	158	2
100	170	42	1,5	465	1290	2000	29320EJ	3,95	130	147	1,5
	210	67	3	680	2100	1500	29420MC	11,8	150	175	2,5
110	190	48	2	610	1730	1600	29322EJ	5,5	145	164	2
	230	73	3	1060	2800	1400	29422MC	14,5	165	193	2,5
120	210	54	2,1	765	2120	1400	29324EJ	7,6	160	181	2
	250	78	4	1200	3000	1300	29424MC	18,1	180	209	3
130	270	85	4	1360	3800	1200	29426MC	22,5	195	227	3
140	240	60	2,1	900	2600	1300	29328MC	11	185	208	2
	280	85	4	1500	4000	1200	29428MC	24,2	205	236	3
150	250	60	2,1	930	2700	1200	29330MC	11,5	195	219	2
	300	90	4	1700	4800	1100	29430MC	29,4	220	254	3
160	320	95	5	1910	5500	1000	29432MC	33,3	235	270	4
170	280	67	3	1100	3400	1100	29334MC	15,1	220	245	2,5
180	300	73	3	1300	4000	1100	29336MC	19,1	235	262	2,5
	360	109	5	2400	7000	900	29436MC	52	265	304	4
190	320	78	4	1500	4600	950	29338MC	24,8	250	280	3
200	280	48	2,1	650	2600	1150	29240MC	8,76	235	253	2
	340	85	4	1700	5200	900	29340MC	33	265	297	3
	400	122	5	3000	8300	800	29440MC	69	295	337	4
220	300	48	2,1	680	2900	1300	29244MC	9,64	255	271	2
	420	122	6	3150	9400	750	29444MC	74	315	358	5
240	340	60	2,1	710	3300	890	29248MC	16,7	290	308	2
	440	122	6	3300	10000	750	29448MC	79	335	378	5
260	360	60	2,1	810	3610	890	29252MC	18,5	310	326	2
	420	95	5	2300	8000	750	29352MC	48,5	335	370	4
	480	132	6	3900	11000	670	29452MC	105	365	412	5

SPHERICAL ROLLER THRUST BEARINGS ZVL SLOVAKIA, a. s.



DIMENSIONS mm				BASIC LOAD RATING kN		LIMITING SPEED FOR LUBRICATION min ⁻¹	BEARING DESIGNATION	WEIGHT kg	ABUTMENT AND FILLET DIMENSIONS		
d	D	B	rs min				WITH CYLINDRICAL BORE		da min	Da max	ra max
280	380	60	2,1	860	3950	840	29256MC	19,5	325	347	2
	440	95	5	2400	8300	710	29356MC	52,5	355	390	4
300	420	73	3	1000	4700	750	29260MC	30,5	360	380	2,5
	480	109	5	2800	10000	630	29360MC	74	385	423	4
320	440	73	3	1100	5000	710	29264MC	32,9	380	400	2,5
	580	155	7,5	4400	16800	560	29464MC	175	450	500	6
340	620	170	7,5	5100	21000	500	29468MC	218	475	530	6
360	500	85	4	1410	6500	630	29272MC	51,8	430	453	3
380	520	85	4	1550	7600	600	29276MC	52,8	450	473	3
	670	175	7,5	5400	23000	470	29476MC	263	525	580	6
400	540	85	4	1600	8000	600	29280MC	55,3	470	493	3
	710	185	7,5	6300	26000	450	29480MC	306	550	615	6
420	730	185	7,5	6500	27000	430	29484MC	323	575	635	6
440	780	206	9,5	7400	30000	400	29488MC	407	605	675	8
480	850	224	9,5	9200	37000	340	29496MC	518	660	735	8





INSERT BALL BEARING AND INSERT BALL BEARING HOUSING UNITS



INSERT BALL BEARINGS

Insert ball bearings are mainly used in simple arrangements, e. g. in agricultural machines, conveyer devices, food processing machines, construction machines, etc.

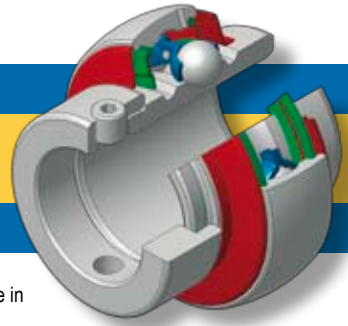

DESIGN SPECIFICATIONS

MAIN DIMENSIONS

The main dimensions of insert ball bearings specified in the dimension tables are in accordance with the international standards ISO 2264 and DIN 626 T1.

The dimensions of the rings are in accordance with the international standard ISO 3145.

LUBRICATION

The insert ball bearings do not require maintenance. The filling of the lubrication is usually sufficient for the whole operation life of the bearing.

RADIAL CLEARANCE

Insert ball bearings have radial clearance C3 in the range valid for the single row ball bearings.

OPERATION TEMPERATURE

Insert ball bearings are filled with high quality plastic lubricant, which is suitable for maximum operation temperature 100 °C and minimum temperature -30 °C.

LIMITING ROTATION SPEED

The limiting rotation speed of the insert ball bearings depends mainly on the arrangement on the shaft (see the following table).

Limiting rotation speed for various shaft diameter tolerances

BORE DIAMETER	LIMITING ROTATION SPEED WITH PLASTIC LUBRICANT FOR BEARINGS TYPE UA, UE, UD AND UC WITH SHAFT DIAMETER TOLERANCE				
	h6	h7	h8	h9	h11
„d“ mm	min ⁻¹				
17	9500	6000	4300	1500	950
20	8500	5300	3800	1300	850
25	7000	4500	3200	1000	700
30	6300	4000	2800	900	630
35	5300	3400	2200	750	530
40	4800	3000	1900	670	480
45	4300	2600	1700	600	430
50	4000	2400	1600	560	400
55	3600	2000	1400	500	360
60	3400	1900	1300	480	340
65	3000	1700	1100	430	300
70	2800	1600	1000	400	280
80	2400	1400	900	360	240
90	2000	1200	800	320	200

RADIAL EQUIVALENT DYNAMIC LOAD

Radial equivalent dynamic load is calculated in the same way as for the standard ball bearings:

$$P_r = F_r \quad \text{for } F_a/F_r \leq e$$

$$P_r = 0,56 F_r + Y F_a \quad \text{for } F_a/F_r > e$$

Factors

F_a/C_{or}	e	Y
0.025	0.22	2
0.040	0.24	1.8
0.070	0.27	1.6
0.130	0.31	1.4
0.250	0.37	1.2
0.500	0.44	1

RADIAL EQUIVALENT STATIC LOAD

Radial equivalent static load

of insert ball bearings is calculated as follows:

$$P_{or} = 0,6 F_r + 0,5 F_a \quad \text{pre } (P_{or} \geq F_r)$$

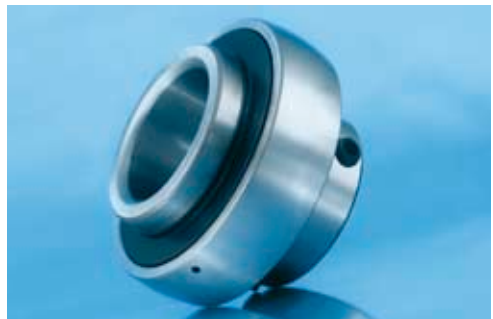

INSERT BALL BEARINGS ZVL SLOVAKIA, a.s.

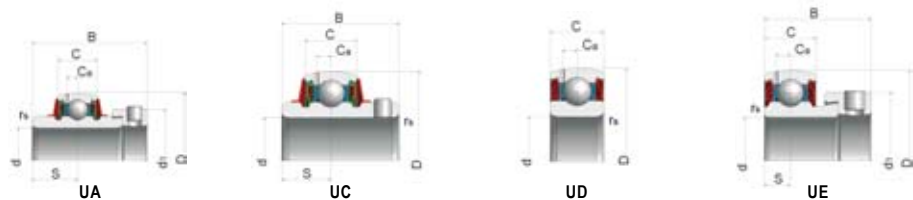

DIMENSIONS mm									RADIAL CLEARANCE mm		BASIC LOAD RATING kN		BEARING DESIGNATION	WEIGHT kg
d	D	B	C	rs min	d1 max	S	Ca	C3						
								min	max					
17	40	37,4	14		28	13,9	3,5	0,011	0,025	9,57	4,79	UA203	0,14	
	40		12	1			3,5	0,011	0,025	9,6	4,8	UD203	0,056	
	40	28,6	12	0,6	28,6	6	3,5	0,011	0,025	9,6	4,8	UE203	0,13	
	47	31	16	1,5		12,7	4,2	0,011	0,025	12,8	6,7	UC203	0,18	
20	47	43,6	16		33,3	17	4,2	0,013	0,028	12,8	6,7	UA204	0,2	
	47	31	16	1,5		12,7	4,2	0,013	0,028	12,8	6,7	UD204	0,16	
	47		14				4,2	0,013	0,028	12,8	6,7	UD204	0,1	
	47	31	14	0,6	33,3	7	4,2	0,013	0,028	12,8	6,7	UE204	0,15	
25	52	44,4	15		38,1	17,5	4,3	0,013	0,028	14,02	7,88	UA205	0,23	
	52	34,1	15	1,5		14,3	4,3	0,013	0,028	14,02	7,88	UC205	0,17	
	52		15	1,5			4,3	0,013	0,028	14,02	7,88	UD205	0,126	
	52	31	15	0,6	38	7,5	4,3	0,013	0,028	14,02	7,88	UE205	0,18	
30	62	48,4	16	1	45	18,3	5	0,013	0,028	19,5	11,3	UA206	0,36	
	62	38,1	16	1		15,9	5	0,013	0,028	19,46	11,31	UC206	0,28	
	62		16	1,5			5	0,013	0,028	19,46	11,31	UD206	0,195	
	62	35,7	16	1	45	8	5	0,013	0,028	19,46	11,31	UE206	0,28	
35	72	51,1	17	1,5	55,6	18,8	5,7	0,015	0,033	25,67	15,3	UA207	0,55	
	72	42,9	17	1,5		17,5	5,7	0,015	0,033	25,67	15,3	UC207	0,41	
	72		17	1,5			5,7	0,015	0,033	25,67	15,3	UD207	0,278	
	72	38,9	17	1,5	55,6	9,5	5,7	0,015	0,033	25,67	15,3	UE207	0,42	
40	80	56,3	18	1,5	60	21,4	6,3	0,015	0,033	29,52	18,14	UA208	0,7	
	80	49,2	18	1,5		19	6,3	0,015	0,033	29,52	18,14	UC208	0,55	
	80		18	1,1			6,3	0,015	0,033	29,52	18,14	UD208	0,36	
	80	43,7	18	1,5	60	11	6,3	0,015	0,033	29,52	18,14	UE208	0,57	
45	85	56,4	22	1,5	63,5	21,4	6,3	0,018	0,036	31,68	20,68	UA209	0,74	
	85	49,2	22	1,5		19	6,3	0,018	0,036	31,68	20,68	UC209	0,68	
	85		19	1,1			6,3	0,018	0,036	31,68	20,68	UD209	0,42	
	85	43,7	19	0,6	63,5	9,5	6,3	0,018	0,036	31,7	20,7	UE209	0,82	
50	90	62,8	22	1,5	69,9	24,6	6,6	0,018	0,036	35,1	23,2	UA210	1,01	
	90	51,6	22	1,5		19	6,6	0,018	0,036	35,07	23,18	UC210	0,78	
	90		20	1,1			6,6	0,018	0,036	35,07	23,18	UD210	0,47	
	90	43,7	20	0,6	69,9	10	6,6	0,018	0,036	35,1	23,2	UE210	0,85	
55	100	55,6	25	1,5		22,2	7	0,023	0,043	43,38	29,22	UC211	1,07	
60	110	65,1	27	1,5		25,4	7,6	0,023	0,043	47,76	32,02	UC212	1,52	
65	120	65,1	28	1,5		25,4	8,5	0,023	0,043	57,21	40	UC213	1,8	
70	125	74,6	29	1,5		30,2	8	0,025	0,051	60,82	45,03	UC214	2,06	
75	130	77,8	30	1,5		33,3	9,2	0,025	0,051	66,11	49,5	UC215	2,19	
80	140	82,6	33	2		33,3	9	0,025	0,051	72,5	53	UC216	2,82	
85	150	85,7	35	2		34,1	10	0,03	0,058	83,21	63,96	UC217	3,46	



INSERT BALL BEARING HOUSING UNITS

Insert ball bearing housing units are made of cast iron and have a spherical hollow where the insert ball bearing is located. The bearing type is inserted according to the housing design request /UE, UC, UD, UE/. The housing units are supplied as pillow block type /SG design/ or flanged type /FG design/.



DESIGN SPECIFICATION

APPLICATION

The insert ball bearings with housing units are used mainly in agricultural machines, conveyor systems, food industry machines as insert bearing units. In general, they are used in arrangements, where the insert bearing unit provides an economical solution with simple arrangement design. For the purpose of potential re-lubrication, the housing units are equipped with grease nipple and grease duct leading straight to the bearing. Should the re-lubrication of insert bearing be not required by its operating conditions, the threaded hole can be plugged.

MAIN DIMENSIONS

The housing unit main dimensions are in the accordance with standards ISO 3228, the eccentric locking collar dimensions are in accordance with standards ISO 2145.

DESIGNATION

For designation of the housing units and complete insert bearing units see the following table.



INSERT BALL BEARING HOUSING UNITS ZVL SLOVAKIA, a.s.

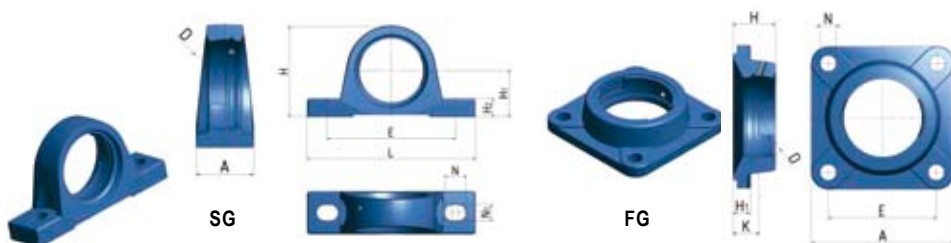

SQUARE FLANGED HOUSING UNIT - FG TYPE									
DIMENSIONS mm							WEIGHT kg	HOUSING UNIT DESIGNATION	DESIGNATION OF HOUSING UNIT WITH BEARING UC
A	D	E	H	H1	N	K			
86	40	64	25,5	11	12	15	1	FG203	FGC203
86	47	64	25,5	11	12	15	0,95	FG204	FGC204
95	52	70	27	14	12	16	1,2	FG205	FGC205
108	62	83	31	14,3	12	18	1,89	FG206	FGC206
117	72	92	34	15,5	14	19	2,39	FG207	FGC207
130	80	102	36	15,5	16	21	2,79	FG208	FGC208
137	85	105	38	17,5	16	22	3,18	FG209	FGC209
143	90	111	40	17,5	16	22	3,68	FG210	FGC210
162	100	130	43	19,5	19	25	3,4	FG211	FGC211
175	110	143	48	19,5	19	29	4,17	FG212	FGC212
187	120	149	50	23	19	30	5,32	FG213	FGC213
193	125	152	54	23	19	31	5,92	FG214	FGC214
200	130	159	56	23	19	34	6,65	FG215	FGC215
208	140	165	58	24	23	34	7,89	FG216	FGC216
220	150	175	63	25	23	36	9,18	FG217	FGC217

PILLOW BLOCK HOUSING UNIT - SG TYPE									
DIMENSIONS mm							WEIGHT kg	HOUSING UNIT DESIGNATION	DESIGNATION OF HOUSING UNIT WITH BEARING UC
A	D	E	L	H	H1	H2			
36	40	96	127	60	30,2	13	0,67	SG203	SGC203
38	47	95	127	65	33,3	14	0,79	SG204	SGC204
38	52	105	140	71	36,5	15	0,91	SG205	SGC205
48	62	121	165	83	42,9	17	1,56	SG206	SGC206
48	72	127	167	93	47,6	18	1,86	SG207	SGC207
54	80	137	184	98	49,2	18	2,21	SG208	SGC208
54	85	146	190	106	54	20	2,47	SG209	SGC209
60	90	159	206	114	57,2	21	3,18	SG210	SGC210
60	100	171	219	126	63,5	23	3,95	SG211	SGC211
70	110	184	241	138	69,8	25	5,1	SG212	SGC212
70	120	203	264	151	76,2	27	6,2	SG213	SGC213
72	125	210	266	157	79,4	27	6,64	SG214	SGC214
74	130	217	275	163	82,6	28	7,53	SG215	SGC215
78	140	232	292	175	88,9	30	9,03	SG216	SGC216
83	150	247	310	187	95,2	32	11,28	SG217	SGC217



SPHERICAL PLAIN BEARINGS

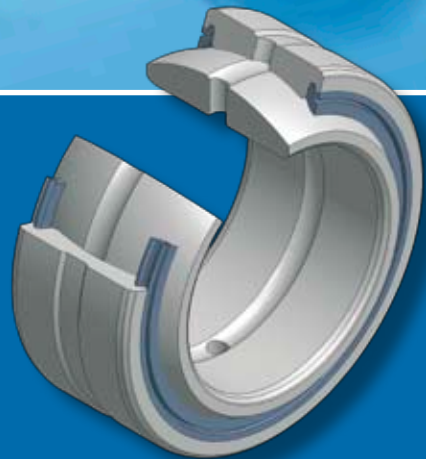

SPHERICAL PLAIN BEARINGS

Spherical bearings type GE are radial plain bearings consisting of an outer ring and an inner ring made of bearing steel and with spherical sliding contact surface. These bearings are suitable for arrangements with heavy radial load at low misalignment and oscillation.

Furthermore the bearings can carry specific axial load in both directions.

DESIGN SPECIFICATIONS

MAIN DIMENSIONS

Main dimensions of spherical bearings type GE are in accordance with the international standards ISO 6124/1.

DESIGNATION

Designation of standard spherical bearings is specified in the dimension tables and consists of type designation (GE) and dimension (the number specifies the inner diameter in mm) e. g. GE30. Non-standard designation (radial clearance, sealing, dimension differences) are designated according to the standard STN 02 04608 (except the designation "E"). Symbol "E" – bearings with phosphated surface, e. g. GE30E.

BORE DIAMETER		RADIAL CLEARANCE					
over	incl.	C2		NORMAL		C3	
		min.	max.	min.	max.	min.	max.
mm		µm					
12	20	10	40	40	82	82	124
20	35	12	50	50	100	100	150
35	60	15	60	60	120	120	180
60	90	18	72	72	142	142	212
90	140	18	85	85	165	165	245
140	240	18	100	100	192	192	284

RADIAL CLEARANCE

Commonly produced spherical bearings have normal radial clearance which is not indicated. Radial clearance values are specified in the following table:

SPHERICAL PLAIN BEARINGS ZVL SLOVAKIA, a. s.

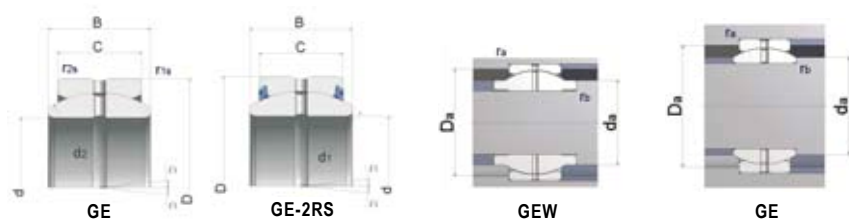

DIMENSIONS mm									RADIAL CLEARANCE mm		BASIC LOAD RATING kN		BEARING DESIGNATION		CONNECTING DIMENSIONS				WEIGHT kg
d	D	B	C	d2	r1s min	r2s max	α °	normal					da max.	Da max.	ra max.	rb max.			
								min	max										
15	26	12	9	22	0,6	0,6	8	0,04	0,082	17	85	GE15E	GE15E-2RS	18	23	0,5	0,5	0,025	
20	35	16	12	29	0,6	0,6	9	0,04	0,082	30	146	GE20E	GE20E-2RS	24	31	0,6	0,5	0,061	
25	42	20	16	35,5	0,6	0,6	7	0,05	0,1	48	240	GE25E	GE25E-2RS	29	38	0,6	0,5	0,11	
30	47	22	18	40,7	0,6	0,6	6	0,05	0,1	62	310	GE30E	GE30E-2RS	34	43	0,6	0,5	0,14	
35	55	25	20	47	0,6	1	6	0,05	0,1	80	400	GE35E	GE35E-2RS	39	50	0,8	0,6	0,22	
40	62	28	22	53	0,6	1	7	0,06	0,12	100	500	GE40E	GE40E-2RS	45	57	0,8	0,6	0,3	
45	68	32	25	60	0,6	1	7	0,06	0,12	127	640	GE45E	GE45E-2RS	50	63	0,8	0,6	0,4	
50	75	35	28	66	0,6	1	6	0,06	0,12	156	780	GE50E	GE50E-2RS	56	70	0,8	0,6	0,54	
55	85	40	32	74	0,6	1	7	0,06	0,12	190	950	GE55E	GE55E-2RS	62	80	1	0,8	0,71	
60	90	44	36	80	1	1	6	0,06	0,12	245	1220	GE60E	GE60E-2RS	66	84	1	0,8	1,05	
70	105	49	44	92	1	1	6	0,072	0,142	313	1560	GE70E	GE70E-2RS	77	99	1	0,8	1,55	
80	120	55	45	105	1	1	6	0,072	0,142	400	2000	GE80E	GE80E-2RS	89	114	1	0,8	2,31	
90	130	60	50	115	1	1	5	0,072	0,142	488	2440	GE90E	GE90-2RS	98	124	1	1	2,75	
100	150	70	55	130	1	1	7	0,085	0,165	607	3030	GE100E	GE100E-2RS	109	144	1	1	4,45	
110	160	70	55	140	1	1	6	0,085	0,165	654	3270	GE110E	GE110E-2RS	121	154	1	1	4,82	
120	180	85	70	160	1	1	6	0,085	0,165	950	4750	GE120E	GE120E-2RS	135	174	1	1	8,05	
140	210	90	70	180	1	1	7	0,085	0,165	1070	5350	GE140E	GE140E-2RS	155	204	1	1	11,02	
160	230	105	80	200	1	1	8	0,1	0,192	1360	6800	GE160E	GE160E-2RS	170	224	1	1	14,01	
180	260	105	80	225	1,1	1,1	6	0,1	0,192	1530	7650	GE180E	GE180E2RS	198	253	1	1	18,65	
200	290	130	100	250	1,1	1,1	7	0,1	0,192	2120	10600	GE200E	GE200-2RS	212	283	1	1	28,03	





SPECIAL BEARINGS AND SPECIAL ANGULAR CONTACT BEARINGS

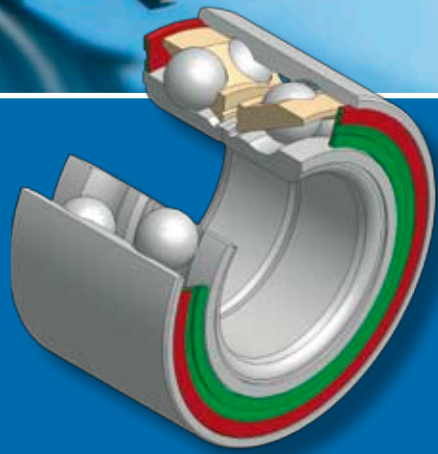

SPECIAL BEARINGS

Special rolling bearings have non-standardized dimensions or design, eventually both. They are used for arrangements, where the designer because of various reasons cannot use standardized standard or modified bearings.

These bearings are used as relieving pulleys in various machines, instruments and devices or they are used for arrangements in various branches of industry.

Specific group of special angular contact bearings are bearings for clutches that form integrated units to control the clutch. Special rolling bearings can be also used in other arrangements than originally intended for.

All technical specifications and other data necessary for calculation and arrangement of special rolling bearings are specified in the dimension tables.



DESIGN SPECIFICATIONS

DESIGNATION

The designation of special single row ball bearings corresponds with the designation method of special rolling bearings, e. g.: PLC 03-80, where the symbol "PLC" is a common symbol for special rolling bearings, numerical character "0" stands for design group of single row ball bearings and other numerical character (1-12) dimension group according to outer diameter of the bearing. Numeric character behind the dash is the ordinal number in the corresponding dimension group. Non-standardized dimensions apart from the further shown exceptions are designated according to the following scheme:

DESIGNATION SCHEME

OF NON-STANDARDIZED BEARINGS



Symbol for special rolling bearings

Design group or rolling bearing type

- 0 - single row ball
- 1 - double row ball
- 2 - axial ball
- 4 - cylindrical, needle and single row spherical
- 5 - cylindrical, needle, double and multi row spherical
- 6 - single row, double row and four row tapered
- 7 - spindles
- 8 - assembling units and single parts
- 9 - axial cylindrical, needle, spherical and tapered

Dimension group 1 – 12 according to the outer diameter D

Ordinal number in the corresponding dimension group

Difference of the inner design

SPECIAL BEARINGS ZVL SLOVAKIA, a. s.

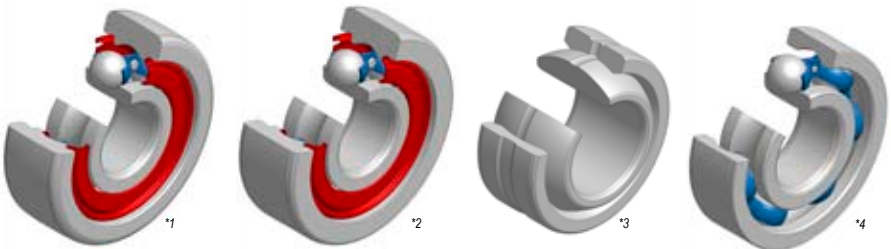

SPECIAL BEARINGS ZVL SLOVAKIA, a. s.

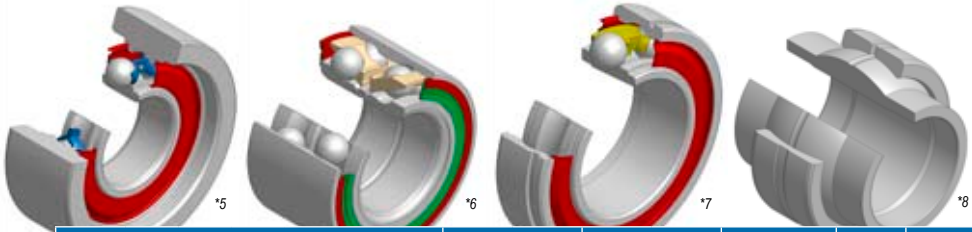

DIMENSIONS mm							BASIC LOAD RATING kN		LIMITING SPEED FOR LUBRICATION min ⁻¹		BEARING DESIGNATION	WEIGHT kg	PICT.
d	D	B	C	R	rs min.	r1s min.	C	Co	Gr	Gr			
12	36	10	11,9	60	0,6	1	6,905	3,1	22000		PLC 03-80	0,059	*1
	36	10	12		0,6		6,905	3,1	22000		PLC 03-222	0,058	*2
19,05	36,51	15,06	19,05		0,6		46	238			PLC 32-600	0,88	*3
20	51	15			1,1		16	7,94	14000	17000	PLC 04-30	0,126	*4
	74,2	16	28		1	0,6	19,6	11,2	11000		PLC 05-13	0,545	*5
30	68	37			0,5	2,2	39,8	38,3	6500		PLC 15-12	0,54	*6
	62	16	18		1,5	0,8	15,956	10,328	10600	12600	PLC 04-208	0,154	*7
40	68	60,5	28		1	0,3	127	640			PLC 33-200	0,38	*8

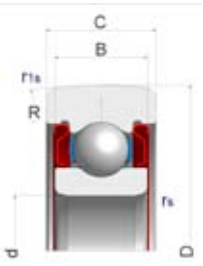

*1 - When using the bearing as relieving pulley the values for load rating Cr, Cor and limiting rotation speed are decreased on 2/3 of the values specified in the table.

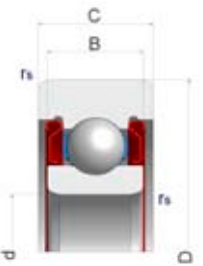

*2 - Bearing with metal cage covered on both sides and with radial clearance Gr 0,065 to 0,075 mm.

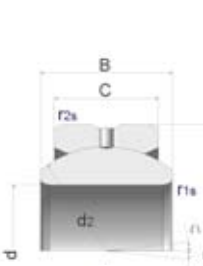

*3 - spherical bearing with radial clearance Gr 0,040 to 0,082 mm.

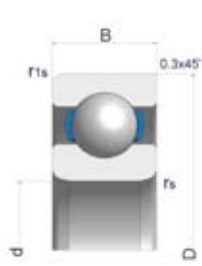

*4 - Ball bearing with metal cage and radial clearance Gr 0,005 to 0,020 mm.

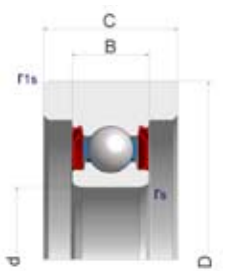

*5 - Special ball bearing covered by metal shields and with extended outer ring, with radial clearance Gr 0,005 to 0,020 mm.

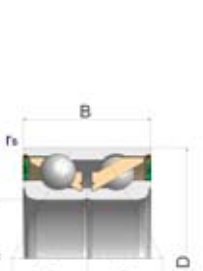

*6 - Double row angular contact ball bearing, sealed, for arrangement on the front wheel of a car.

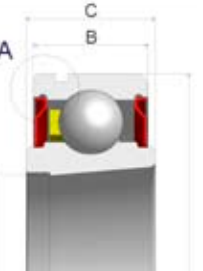

*7 - Single row ball bearing with tapered bore, sealed on both sides, filled with plastic lubricant, with radial clearance Gr 0,005 to 0,020 mm.

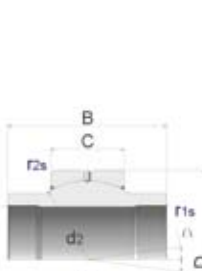

*8 - Special spherical bearing with extended inner ring with radial clearance Gr 0,20 to 0,35 mm.



SPECIAL ANGULAR CONTACT BEARINGS ZVL SLOVAKIA a.s.



DIMENSIONS mm						BASIC LOAD RATING kN		LIMITING SPEED FOR LUBRICATION min ⁻¹		BEARING DESIGNATION	WEIGHT kg	PICT.	
d	D	T	d1	d2	d3	B	T1						
45.2	94,5	50,5	95	57		16	21	20,3	16,3	5300	PLC 06-204	0,78	*1
	115	58	102	76,4		55	39	27,6	23,3	4200		1,42	*2
68	128	51	106	90	100	42,5	33,5	33,5	27,6	4000	KZI-5	1,88	*3
	128	51	106	90	100	42,5	33,5	33,5	27,6	4000	KZI-5/D	1,87	*3
	128	69,7	106	90	100	42,5	52	33,5	27,6	4000	KZI-5/L	2,38	*3
106	145		138			18	25	23,8	24,3	2500	PLC 08-13	0,94	*4

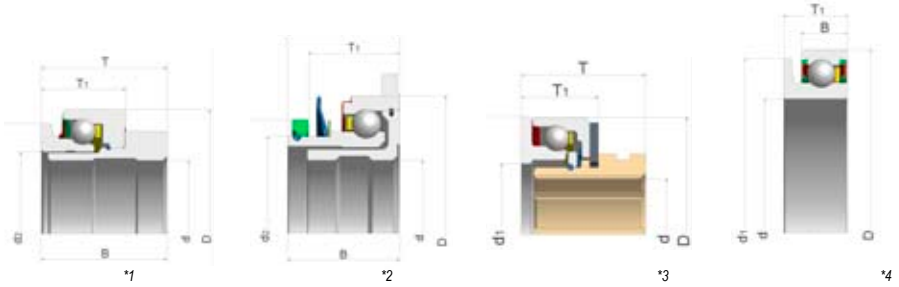



ACCESSORIES

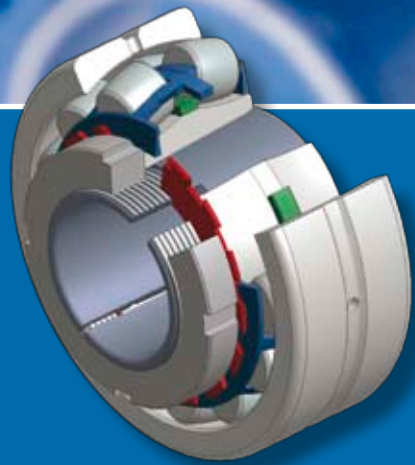
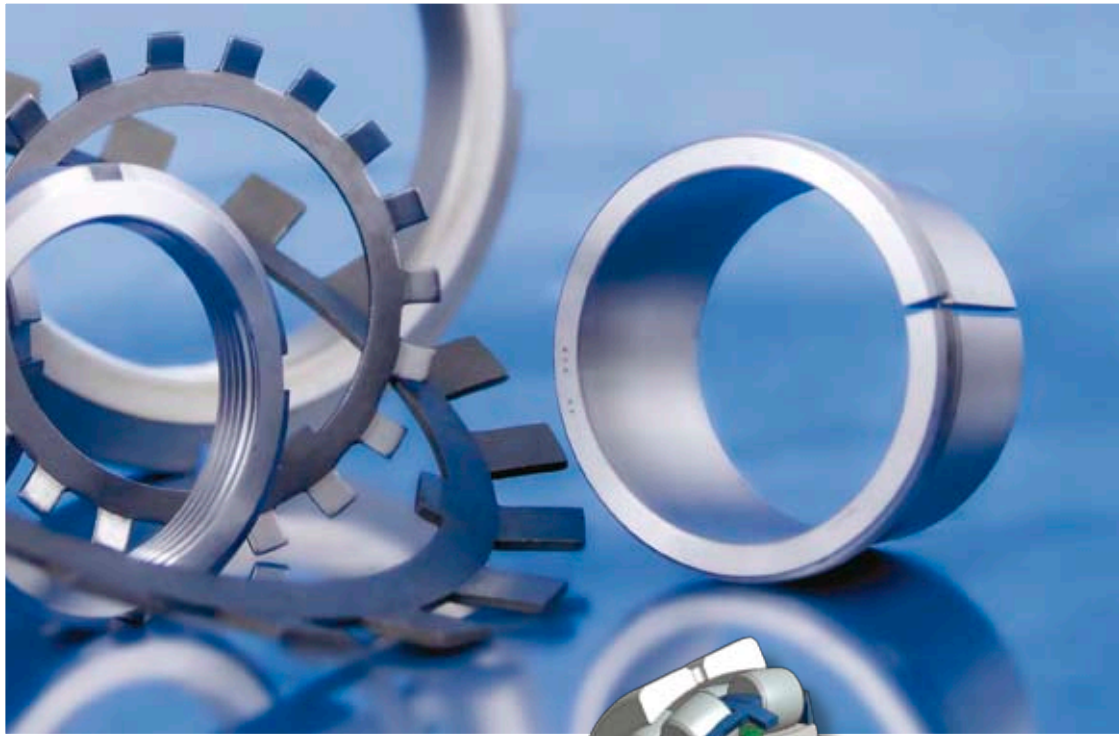

ACCESSORIES

Accessories are standard machine components serving for fixing rolling bearings on the shaft or in the housing bore.

They are adapter sleeves, withdrawal sleeves, locknuts and withdrawal nuts, locking washers and snap rings for bearings with snap ring groove on the outer ring.

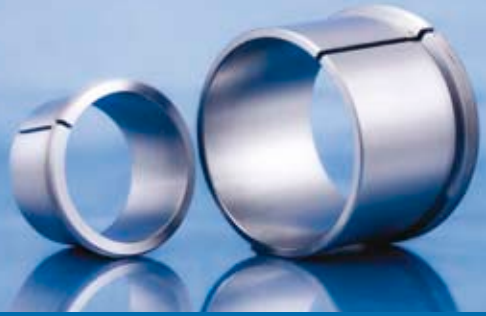

ADAPTER SLEEVES AND WITHDRAWAL SLEEVES

Adapter sleeves and withdrawal sleeves are used for fixing bearings with tapered bore on cylindrical shaft. The sleeves facilitate bearing mounting and dismounting and they often simplify the arrangement design. Adapter sleeves are more common and their mounting is more simple than mounting of withdrawal sleeves. Bearings with the withdrawal sleeve need to be rested on non-rolling part, e.g. housing shoulder. Once the withdrawal sleeves are pressed into the bearing bore with a lock nut or lock plate they need to be fixed on the shaft.

ADAPTER SLEEVES

Adapter sleeves are supplied complete with lock nut and locking washer. The sleeves are slotted and the outer part taper is 1:12. The dimensions of the adapter sleeves comply with ISO 113/l. standard. Adapter sleeves of bigger diameter are produced as standard with oil ducts at the threaded side and an oil distributor groove on the outside surface – designation OH...H. The sleeves with distributor grooves in the bore as well as the outside surface are designated OH...HB. The sleeves with an oil supply duct at the side opposite to the threaded section and a distributor groove in the outside surface are designated OH. The sleeves with a distributor grooves on the surface as well as the bore are designated OH...B.



WITHDRAWAL SLEEVES

Withdrawal sleeves are slotted and have a taper surface. Dimensions of the withdrawal sleeves comply with ISO 2982 standard. The withdrawal nuts are not included and they must be ordered separately. Withdrawal sleeves of bigger diameter are produced as standard with oil ducts at the threaded side and an oil distributor grooves on the outside surface as well as the bore – designation AOH.

LOCKNUTS AND WITHDRAWAL NUTS

Lock nuts are used for fixing the bearing inner rings on the adapter sleeves or directly on the shaft, eventually for mounting and dismounting the bearing on the withdrawal sleeves. Lock nuts are equipped with grooves on the outer diameter to facilitate the manipulation with them. Dimensions of lock nuts are in accordance with ISO 2982.



LOCKING WASHERS, LOCKING CLIP

Locking washers are used for fixing the lock nuts of smaller diameter and the locking clips are used for fixing the lock nuts of bigger diameter. Locking washers are made of a deep-drawing sheet steel and their dimensions comply with ISO 2982 standard. Locking clips are also made of a deep-drawing sheet steel and they are attached to withdrawal sleeve with a bolt. The bolt and the washer are included in the delivery.



ADAPTER SLEEVES ZVL SLOVAKIA, a. s.

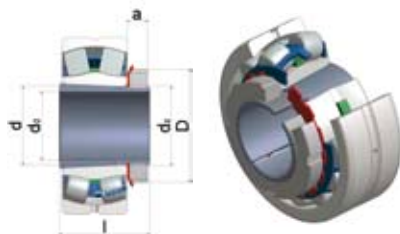

d0	DIMENSIONS mm						WEIGHT kg	SLEEVE DESIGNATION INCL. NUT AND LOCKING	APPROPRIATE COMPONENTS		
	d	D	l	a	a1	dz			dz1	NUT	WASHER
12	15	25	19	6	-	M15x1	-	0,024	H202	KM2	MB2
	15	25	22	6	-	M15x1	-	0,026	H302	KM2	MB2
	15	25	25	6	-	M15x1	-	0,032	H2302	KM2	MB2
14	17	28	20	6	-	M17x1	-	0,03	H203	KM3	MB3
	17	28	24	6	-	M17x1	-	0,036	H303	KM3	MB3
	17	28	27	6	-	M17x1	-	0,042	H2303	KM3	MB3
17	20	32	24	7	-	M20x1	-	0,036	H204	KM4	MB4
	20	32	24	7	-	M20x1	-	0,04	H304	KM4	MB4
	20	32	24	7	-	M20x1	-	0,05	H2304	KM4	MB4
20	25	38	26	8	-	M25x1,5	-	0,064	H205	KM5	MB5
	25	38	29	8	-	M25x1,5	-	0,071	H305	KM5	MB5
	25	38	35	8	-	M25x1,5	-	0,085	H2305	KM5	MB5
25	30	45	27	8	-	M30x1,5	-	0,086	H206	KM6	MB6
	30	45	31	8	-	M30x1,5	-	0,095	H306	KM6	MB6
	30	45	38	8	-	M30x1,5	-	0,11	H2306	KM6	MB6
30	35	52	29	9	-	M35x1,5	-	0,12	H207	KM7	MB7
	35	52	35	9	-	M35x1,5	-	0,14	H307	KM7	MB7
	35	52	43	9	-	M35x1,5	-	0,16	H2307	KM7	MB7
35	40	58	31	10	-	M40x1,5	-	0,16	H208	KM8	MB8
	40	58	36	10	-	M40x1,5	-	0,17	H308	KM8	MB8
	40	58	46	10	-	M40x1,5	-	0,22	H2308	KM8	MB8
40	45	65	33	11	-	M45x1,5	-	0,21	H209	KM9	MB9
	45	65	39	11	-	M45x1,5	-	0,23	H309	KM9	MB9
	45	65	50	11	-	M45x1,5	-	0,27	H2309	KM9	MB9
45	50	70	35	12	-	M50x1,5	-	0,24	H210	KM10	MB10
	50	70	42	12	-	M50x1,5	-	0,27	H310	KM10	MB10
	50	70	55	12	-	M50x1,5	-	0,34	H2310	KM10	MB10
50	55	75	37	12	-	M55x2	-	0,28	H211	KM11	MB11
	55	75	45	12	-	M55x2	-	0,32	H311	KM11	MB11
	55	75	59	12	-	M55x2	-	0,39	H2311	KM11	MB11
55	60	80	38	13	-	M60x2	-	0,31	H212	KM12	MB12
	60	80	47	13	-	M60x2	-	0,36	H312	KM12	MB12
	60	80	62	13	-	M60x2	-	0,45	H2312	KM12	MB12
60	65	85	40	14	-	M65x2	-	0,36	H213	KM13	MB13
	65	85	50	14	-	M65x2	-	0,42	H314	KM13	MB13
	65	85	65	14	-	M65x2	-	0,52	H2313	KM13	MB13
60	70	92	41	14	-	M70x2	-	0,55	H214	KM14	MB14
	70	92	52	68	-	M70x2	-	0,67	H314	KM14	MB14
	70	92	41	14	-	M70x2	-	0,88	H2314	KM14	MB14
65	75	98	43	15	-	M75x2	-	0,66	H215	KM15	MB15
	75	98	55	15	-	M75x2	-	0,78	H315	KM15	MB15
	75	98	73	15	-	M75x2	-	1,1	H2315	KM15	MB15
70	80	105	46	17	-	M80x2	-	0,81	H216	KM16	MB16
	80	105	59	17	-	M80x2	-	0,95	H316	KM16	MB16
	80	105	78	17	-	M80x2	-	1,2	H2316	KM16	MB16



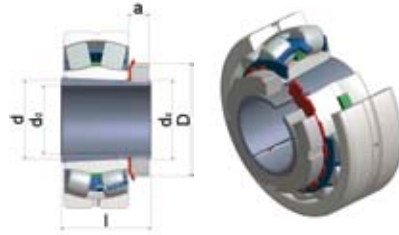

d0	DIMENSIONS mm						WEIGHT kg	SLEEVE DESIGNATION INCL. NUT AND LOCKING	APPROPRIATE COMPONENTS		
	d	D	l	a	a1	dz			dz1	NUT	WASHER
75	85	110	50	18	-	M85x2	-	0,94	H217	KM17	MB17
	85	110	63	18	-	M85x2	-	1,1	H317	KM17	MB17
	85	110	82	18	-	M85x2	-	1,25	H2317	KM17	MB17
80	90	120	62	18	-	M90x2	-	1,1	H218	KM18	MB18
	90	120	65	18	-	M90x2	-	1,2	H318	KM18	MB18
	90	120	86	18	-	M90x2	-	1,6	H2318	KM18	MB18
85	95	125	55	19	-	M95x2	-	1,25	H219	KM19	MB19
	95	125	68	19	-	M95x2	-	1,4	H319	KM19	MB19
	95	125	90	19	-	M95x2	-	1,8	H2319	KM19	MB19
90	100	130	58	20	-	M100x2	-	1,4	H220	KM20	MB20
	100	130	71	20	-	M100x2	-	1,6	H320	KM20	MB20
	100	130	97	20	-	M100x2	-	2	H2320	KM20	MB20
	100	130	76	20	-	M100x2	-	1,8	H3120	KM20	MB20
95	105	140	60	20	-	M105x2	-	1,6	H221	KM21	MB21
	105	140	74	20	-	M105x2	-	1,85	H321	KM21	MB21
	105	140	101	20	-	M105x2	-	2,46	H2321	KM21	MB21
100	110	145	63	21	-	M110x2	-	1,8	H222	KM22	MB22
	110	145	77	21	-	M110x2	-	2,05	H322	KM22	MB22
	110	155	105	21	-	M110x2	-	2,1	H2322	KM22	MB22
	110	155	81	21	-	M110x2	-	2,75	H3122	KM22	MB22
110	120	145	72	22	-	M120x2	-	1,8	H3024	KML24	MBL24
	120	155	88	22	-	M120x2	-	2,5	H3124	KM24	MB24
	120	155	112	22	-	M120x2	-	3	H2324	KM24	MB24
115	130	155	80	23	-	M130x2	-	2,8	H3026	KML26	MBL26
	130	165	92	23	-	M130x2	-	3,45	H3126	KM26	MB26
	130	165	121	23	-	M130x2	-	4,45	H2326	KM26	MB26
125	140	165	82	24	-	M140x2	-	3,05	H3028	KML28	MBL28
	140	180	97	24	-	M140x2	-	4,1	H3128	KM28	MB28
	140	180	131	24	-	M140x2	-	5,4	H2328	KM28	MB28
135	150	180	87	26	-	M150x2	-	3,75	H3030	KML30	MBL30
	150	195	111	26	-	M150x2	-	5,25	H3130	KM30	MB30
	150	195	139	26	-	M150x2	-	6,4	H2330	KM30	MB30
140	160	190	93	28	-	M160x3	-	5,1	H3032	KML32	MBL32
	160	190	93	28	-	M160x3	-	5,1	OH3032	KML32	MBL32
	160	190	93	28	-	M160x3	-	5,1	OH3032H	KML32	MBL32
	160	190	93	28	-	M160x3	-	5,1	OH3032HB	KML32	MBL32
	160	210	119	28	-	M160x3	-	7,25	H3132	KM32	MB32
	160	210	119	28	-	M160x3	-	7,25	OH3132	KM32	MB32
	160	210	119	28	-	M160x3	-	7,25	OH3132H	KM32	MB32
	160	210	119	28	-	M160x3	-	7,25	OH3132HB	KM32	MB32
	160	210	147	28	-	M160x3	-	8,8	H2332	KM32	MB32
	160	210	147	28	-	M160x3	-	8,8	OH2332	KM32	MB32
150	170	200	101	29	-	M170x3	-	5,8	H3034	KML34	MBL34
	170	200	101	29	-	M170x3	-	5,8	OH3034	KML34	MBL34
	170	200	101	29	-	M170x3	-	5,8	OH3034H	KML34	MBL34
	170	200	101	29	-	M170x3	-	5,8	OH3034HB	KML34	MBL34
	170	200	101	29	-	M170x3	-	5,8	OH3034HB	KML34	MBL34

ADAPTER SLEEVES ZVL SLOVAKIA, a. s.

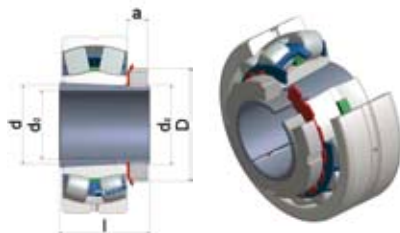

d0	DIMENSIONS mm							WEIGHT kg	SLEEVE DESIGNATION INCL. NUT AND LOCKING	APPROPRIATE COMPONENTS	
	d	D	l	a	a1	dz	dz1			NUT	WASHER
150	170	200	122	29	-	M170x3	-	8,1	H3134	KM34	MB34
	170	200	122	29	-	M170x3	-	8,1	OH3134	KM34	MB34
	170	200	122	29	-	M170x3	-	8,1	OH3134H	KM34	MB34
	170	200	122	29	-	M170x3	-	8,1	OH3134HB	KM34	MB34
	170	200	154	29	-	M170x3	-	9,9	H2334	KM34	MB34
	170	200	154	29	-	M170x3	-	9,9	OH2334	KM34	MB34
	170	200	154	29	-	M170x3	-	9,9	OH2334H	KM34	MB34
	170	200	154	29	-	M170x3	-	9,9	OH2334HB	KM34	MB34
160	180	210	109	30	-	M180x3	-	6,7	H3036	KML36	MBL36
	180	210	109	30	-	M180x3	M6	6,7	OH3036	KML36	MBL36
	180	210	109	30	-	M180x3	M6	6,7	OH3036H	KML36	MBL36
	180	210	109	30	-	M180x3	M6	6,7	OH3036B	KML36	MBL36
	180	210	109	30	-	M180x3	-	9,15	H3136	KM36	MB36
	180	210	109	30	-	M180x3	M6	9,15	OH3136	KM36	MB36
	180	210	109	30	-	M180x3	M6	9,15	OH3136H	KM36	MB36
	180	210	109	30	-	M180x3	M6	9,15	OH3136B	KM36	MB36
	180	210	109	30	-	M180x3	-	11	H2336	KM36	MB36
	180	210	109	30	-	M180x3	M6	11	OH2336	KM36	MB36
	180	210	109	30	-	M180x3	M6	11	OH2336H	KM36	MB36
	180	210	109	30	-	M180x3	M6	11	OH2336B	KM36	MB36
170	190	220	112	31	-	M190x3	-	7,25	H3038	KML38	MBL38
	190	220	112	31	-	M190x3	M6	7,25	OH3038	KML38	MBL38
	190	220	112	31	-	M190x3	M6	7,25	OH3038H	KML38	MBL38
	190	220	112	31	-	M190x3	M6	7,25	OH3038B	KML38	MBL38
	190	220	141	31	-	M190x3	-	10,5	H3138	KM38	MB38
	190	220	141	31	-	M190x3	M6	10,5	OH3138	KM38	MB38
	190	220	141	31	-	M190x3	M6	10,5	OH3138H	KM38	MB38
	190	220	141	31	-	M190x3	M6	10,5	OH3138B	KM38	MB38
	190	220	169	31	-	M190x3	-	12	H2338	KM38	MB38
	190	220	169	31	-	M190x3	M6	12	OH2338	KM38	MB38
	190	220	169	31	-	M190x3	M6	12	OH2338H	KM38	MB38
	190	220	169	31	-	M190x3	M6	12	OH2338B	KM38	MB38
180	200	240	120	32	-	M200x3	-	8,9	H3040	KML40	MBL40
	200	240	120	32	-	M200x3	M6	8,9	OH3040	KML40	MBL40
	200	240	120	32	-	M200x3	M6	8,9	OH3040H	KML40	MBL40
	200	240	120	32	-	M200x3	M6	8,9	OH3040B	KML40	MBL40
	200	240	150	32	-	M200x3	-	12	H3140	KM40	MB40
	200	240	150	32	-	M200x3	M6	12	OH3140	KM40	MB40
	200	240	150	32	-	M200x3	M6	12	OH3140H	KM40	MB40
	200	240	150	32	-	M200x3	M6	12	OH3140B	KM40	MB40
	200	240	176	32	-	M200x3	-	13,5	H2340	KM40	MB40
	200	240	176	32	-	M200x3	M6	13,5	OH2340	KM40	MB40
	200	240	176	32	-	M200x3	M6	13,5	OH2340H	KM40	MB40
	200	240	176	32	-	M200x3	M6	13,5	OH2340B	KM40	MB40
200	220	260	126	30	41	M220x4	-	9,9	H3044	HML44	MBL44
	220	260	126	30	41	M220x4	M6	9,9	OH3044	HML44	MBL44
	220	260	126	30	41	M220x4	M6	9,9	OH3044H	HML44	MBL44
	220	260	126	30	41	M220x4	M6	9,9	OH3044B	HML44	MBL44
	220	260	126	30	41	M220x4	M6	9,9	OH3044HB	HML44	MBL44
	220	260	161	35	-	M220x4	-	15	H3144	HM44	MB44
	220	280	161	35	-	M220x4	M6	15	OH3144	HM44	MB44
	220	280	161	35	-	M220x4	M6	15	OH3144H	HM44	MB44
	220	280	161	35	-	M220x4	M6	15	OH3144B	HM44	MB44
	220	280	161	35	-	M220x4	M6	15	OH3144HB	HM44	MB44
	220	280	161	35	-	M220x4	M6	15	OH3144H	HM44	MB44
	220	280	186	35	-	M220x4	-	17	H2344	HM44	MB44



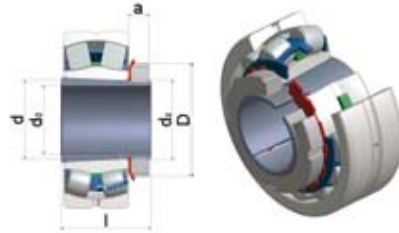

d0	DIMENSIONS mm							WEIGHT kg	SLEEVE DESIGNATION INCL. NUT AND LOCKING	APPROPRIATE COMPONENTS	
	d	D	l	a	a1	dz	dz1			NUT	WASHER
200	220	280	186	35	-	M220x4	M6	17	OH2344	HM44	MB44
	220	280	186	35	-	M220x4	M6	17	OH2344H	HM44	MB44
	220	280	186	35	-	M220x4	M6	17	OH2344B	HM44	MB44
	220	280	186	35	-	M220x4	M6	17	OH2344HB	HM44	MB44
220	240	290	133	34	46	M240x4	-	12	H3048	HML48	MBL48
	240	290	133	34	46	M240x4	M6	12	OH3048	HML48	MBL48
	240	290	133	34	46	M240x4	M6	12	OH3048H	HML48	MBL48
	240	290	133	34	46	M240x4	M6	12	OH3048B	HML48	MBL48
	240	290	133	34	46	M240x4	M6	12	OH3048HB	HML48	MBL48
	240	300	172	37	-	M240x4	-	16	H3148	HM48	MB48
	240	300	172	37	-	M240x4	M6	16	OH3148	HM48	MB48
	240	300	172	37	-	M240x4	M6	16	OH3148H	HM48	MB48
	240	300	172	37	-	M240x4	M6	16	OH3148B	HM48	MB48
	240	300	172	37	-	M240x4	M6	16	OH3148HB	HM48	MB48
	240	300	199	37	-	M240x4	-	19	H2348	HM48	MB48
	240	300	199	37	-	M240x4	M6	19	OH2348	HM48	MB48
	240	300	199	37	-	M240x4	M6	19	OH2348H	HM48	MB48
	240	300	199	37	-	M240x4	M6	19	OH2348B	HM48	MB48
240	300	199	37	-	M240x4	M6	19	OH2348HB	HM48	MB48	
240	260	310	145	34	46	Tr260x4	-	13,5	H3052	HML52	MBL52
	260	310	145	34	46	Tr260x4	M6	13,5	OH3052	HML52	MBL52
	260	310	145	34	46	Tr260x4	M6	13,5	OH3052H	HML52	MBL52
	260	310	145	34	46	Tr260x4	M6	13,5	OH3052B	HML52	MBL52
	260	310	145	34	46	Tr260x4	M6	13,5	OH3052HB	HML52	MBL52
	260	330	190	39	-	Tr260x4	-	21	H3152	HM52	MB52
	260	330	190	39	-	Tr260x4	M6	21	OH3152	HM52	MB52
	260	330	190	39	-	Tr260x4	M6	21	OH3152H	HM52	MB52
	260	330	190	39	-	Tr260x4	M6	21	OH3152B	HM52	MB52
	260	330	190	39	-	Tr260x4	M6	21	OH3152HB	HM52	MB52
	260	330	211	39	-	Tr260x4	-	23	H2352	HM52	MB52
	260	330	211	39	-	Tr260x4	M6	23	OH2352	HM52	MB52
	260	330	211	39	-	Tr260x4	M6	23	OH2352H	HM52	MB52
	260	330	211	39	-	Tr260x4	M6	23	OH2352B	HM52	MB52
260	330	211	39	-	Tr260x4	M6	23	OH2352HB	HM52	MB52	
260	280	330	152	38	50	Tr280x4	-	16	H3056	HML56	MBL56
	280	330	152	38	50	Tr280x4	M6	16	OH3056	HML56	MBL56
	280	330	152	38	50	Tr280x4	M6	16	OH3056H	HML56	MBL56
	280	330	152	38	50	Tr280x4	M6	16	OH3056B	HML56	MBL56
	280	330	152	38	50	Tr280x4	M6	16	OH3056HB	HML56	MBL56
	280	350	195	41	-	Tr280x4	-	23	H3156	HM56	MB56
	280	350	195	41	-	Tr280x4	M6	23	OH3156	HM56	MB56
	280	350	195	41	-	Tr280x4	M6	23	OH3156H	HM56	MB56
	280	350	195	41	-	Tr280x4	M6	23	OH3156B	HM56	MB56
	280	350	195	41	-	Tr280x4	M6	23	OH3156HB	HM56	MB56
	280	350	224	41	-	Tr280x4	-	27	H2356	HM56	MB56
	280	350	224	41	-	Tr280x4	M6	27	OH2356	HM56	MB56
	280	350	224	41	-	Tr280x4	M6	27	OH2356H	HM56	MB56
	280	350	224	41	-	Tr280x4	M6	27	OH2356B	HM56	MB56
280	350	224	41	-	Tr280x4	M6	27	OH2356HB	HM56	MB56	
280	300	360	168	42	54	Tr300x4	-	20,5	H3060	HML60	MSL60
	300	360	168	42	54	Tr300x4	M6	20,5	OH3060	HML60	MSL60
	300	360	168	42	54	Tr300x4	M6	20,5	OH3060H	HML60	MSL60
	300	360	168	42	54	Tr300x4	M6	20,5	OH3060B	HML60	MSL60
	300	360	168	42	54	Tr300x4	M6	20,5	OH3060HB	HML60	MSL60

ADAPTER SLEEVES ZVL SLOVAKIA, a. s.

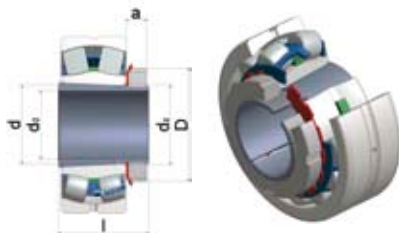

d0	DIMENSIONS mm							WEIGHT kg	SLEEVE DESIGNATION INCL. NUT AND LOCKING	APPROPRIATE COMPONENTS	
	d	D	l	a	a1	dz	dz1			NUT	WASHER
280	300	380	208	40	53	Tr300x4	-	29	H3160	HM60	MS60
	300	380	208	40	53	Tr300x4	M6	29	OH3160	HM60	MS60
	300	380	208	40	53	Tr300x4	M6	29	OH3160H	HM60	MS60
	300	380	208	40	53	Tr300x4	M6	29	OH3160B	HM60	MS60
	300	380	208	40	53	Tr300x4	M6	29	OH3160HB	HM60	MS60
	300	380	240	40	53	Tr300x4	-	32	H3260	HM60	MS60
	300	380	240	40	53	Tr300x4	M6	32	OH3260	HM60	MS60
	300	380	240	40	53	Tr300x4	M6	32	OH3260H	HM60	MS60
	300	380	240	40	53	Tr300x4	M6	32	OH3260B	HM60	MS60
300	380	240	40	53	Tr300x4	M6	32	OH3260HB	HM60	MS60	
300	320	380	171	42	55	Tr320x5	-	22	H3064	HML64	MSL64
	320	380	171	42	55	Tr320x5	M6	22	OH3064	HML64	MSL64
	320	380	171	42	55	Tr320x5	M6	22	OH3064H	HML64	MSL64
	320	380	171	42	55	Tr320x5	M6	22	OH3064B	HML64	MSL64
	320	380	171	42	55	Tr320x5	M6	22	OH3064HB	HML64	MSL64
	320	400	226	42	56	Tr320x5	-	32	H3164	HM64	MS64
	320	400	226	42	56	Tr320x5	M6	32	OH3164	HM64	MS64
	320	400	226	42	56	Tr320x5	M6	32	OH3164H	HM64	MS64
	320	400	226	42	56	Tr320x5	M6	32	OH3164B	HM64	MS64
	320	400	226	42	56	Tr320x5	M6	32	OH3164HB	HM64	MS64
	320	400	258	42	56	Tr320x5	-	35	H3264	HM64	MS64
	320	400	258	42	56	Tr320x5	M6	35	OH3264	HM64	MS64
	320	400	258	42	56	Tr320x5	M6	35	OH3264H	HM64	MS64
	320	400	258	42	56	Tr320x5	M6	35	OH3264B	HM64	MS64
	320	400	258	42	56	Tr320x5	M6	35	OH3264HB	HM64	MS64
320	340	400	187	45	58	Tr340x5	-	27	H3068	HML68	MSL68
	340	400	187	45	58	Tr340x5	M6	27	OH3068	HML68	MSL68
	340	400	187	45	58	Tr340x5	M6	27	OH3068H	HML68	MSL68
	340	400	187	45	58	Tr340x5	M6	27	OH3068B	HML68	MSL68
	340	400	187	45	58	Tr340x5	M6	27	OH3068HB	HML68	MSL68
	340	440	254	55	72	Tr340x5	-	50	H3168	HM68	MS68
	340	440	254	55	72	Tr340x5	M6	50	OH3168	HM68	MS68
	340	440	254	55	72	Tr340x5	M6	50	OH3168H	HM68	MS68
	340	440	254	55	72	Tr340x5	M6	50	OH3168B	HM68	MS68
	340	440	254	55	72	Tr340x5	M6	50	OH3168HB	HM68	MS68
	340	440	288	55	72	Tr340x5	-	51,5	H3268	HM68	MS68
	340	440	288	55	72	Tr340x5	M6	51,5	OH3268	HM68	MS68
	340	440	288	55	72	Tr340x5	M6	51,5	OH3268H	HM68	MS68
	340	440	288	55	72	Tr340x5	M6	51,5	OH3268B	HM68	MS68
	340	440	288	55	72	Tr340x5	M6	51,5	OH3268HB	HM68	MS68
340	360	420	188	45	58	Tr360x5	-	29	H3072	HML72	MSL72
	360	420	188	45	58	Tr360x5	M6	29	OH3072	HML72	MSL72
	360	420	188	45	58	Tr360x5	M6	29	OH3072H	HML72	MSL72
	360	420	188	45	58	Tr360x5	M6	29	OH3072B	HML72	MSL72
	360	420	188	45	58	Tr360x5	M6	29	OH3072HB	HML72	MSL72
	360	460	259	58	75	Tr360x5	-	56	H3172	HM72	MS72
	360	460	259	58	75	Tr360x5	M6	56	OH3172	HM72	MS72
	360	460	259	58	75	Tr360x5	M6	56	OH3172H	HM72	MS72
	360	460	259	58	75	Tr360x5	M6	56	OH3172B	HM72	MS72
	360	460	259	58	75	Tr360x5	M6	56	OH3172HB	HM72	MS72
	360	460	299	58	75	Tr360x5	-	60,5	H3272	HM72	MS72
	360	460	299	58	75	Tr360x5	M6	60,5	OH3272	HM72	MS72
	360	460	299	58	75	Tr360x5	M6	60,5	OH3272H	HM72	MS72
	360	460	299	58	75	Tr360x5	M6	60,5	OH3272B	HM72	MS72
	360	460	299	58	75	Tr360x5	M6	60,5	OH3272HB	HM72	MS72



ADAPTER SLEEVES ZVL SLOVAKIA, a. s.

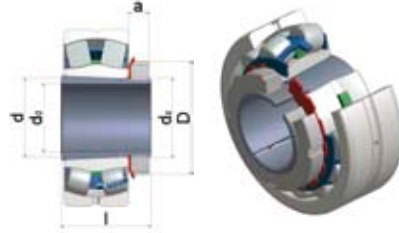

d0	DIMENSIONS mm							WEIGHT kg	SLEEVE DESIGNATION INCL. NUT AND LOCKING	APPROPRIATE COMPONENTS	
	d	D	l	a	a1	dz	dz1			NUT	WASHER
360	380	450	193	48	62	Tr380x5	-	35,5	H3076	HML76	MSL76
	380	450	193	48	62	Tr380x5	M6	35,5	OH3076	HML76	MSL76
	380	450	193	48	62	Tr380x5	M6	35,5	OH3076H	HML76	MSL76
	380	450	193	48	62	Tr380x5	M6	35,5	OH3076B	HML76	MSL76
	380	450	193	48	62	Tr380x5	M6	35,5	OH3076HB	HML76	MSL76
	380	490	264	60	77	Tr380x5	-	61,5	H3176	HM76	MS76
	380	490	264	60	77	Tr380x5	M6	61,5	OH3176	HM76	MS76
	380	490	264	60	77	Tr380x5	M6	61,5	OH3176H	HM76	MS76
	380	490	264	60	77	Tr380x5	M6	61,5	OH3176B	HM76	MS76
	380	490	264	60	77	Tr380x5	M6	61,5	OH3176HB	HM76	MS76
	380	490	310	60	77	Tr380x5	-	69,5	H3276	HM76	MS76
	380	490	310	60	77	Tr380x5	M6	69,5	OH3276	HM76	MS76
	380	490	310	60	77	Tr380x5	M6	69,5	OH3276H	HM76	MS76
	380	490	310	60	77	Tr380x5	M6	69,5	OH3276B	HM76	MS76
380	490	310	60	77	Tr380x5	M6	69,5	OH3276HB	HM76	MS76	
380	400	470	210	52	66	Tr400x5	-	40	H3080	HML80	MSL80
	400	470	210	52	66	Tr400x5	M6	40	OH3080	HML80	MSL80
	400	470	210	52	66	Tr400x5	M6	40	OH3080H	HML80	MSL80
	400	470	210	52	66	Tr400x5	M6	40	OH3080B	HML80	MSL80
	400	470	210	52	66	Tr400x5	M6	40	OH3080HB	HML80	MSL80
	400	520	272	62	82	Tr400x5	-	73	H3180	HM80	MS80
	400	520	272	62	82	Tr400x5	M6	73	OH3180	HM80	MS80
	400	520	272	62	82	Tr400x5	M6	73	OH3180H	HM80	MS80
	400	520	272	62	82	Tr400x5	M6	73	OH3180B	HM80	MS80
	400	520	272	62	82	Tr400x5	M6	73	OH3180HB	HM80	MS80
400	420	490	212	52	66	Tr420x5	-	47	H3084	HML84	MSL84
	420	490	212	52	66	Tr420x5	M6	47	OH3084	HML84	MSL84
	420	490	212	52	66	Tr420x5	M6	47	OH3084H	HML84	MSL84
	420	490	212	52	66	Tr420x5	M6	47	OH3084B	HML84	MSL84
	420	490	212	52	66	Tr420x5	M6	47	OH3084HB	HML84	MSL84
	420	540	304	70	90	Tr420x5	-	80	H3184	HM84	MS84
	420	540	304	70	90	Tr420x5	M6	80	OH3184	HM84	MS84
	420	540	304	70	90	Tr420x5	M6	80	OH3184H	HM84	MS84
	420	540	304	70	90	Tr420x5	M6	80	OH3184B	HM84	MS84
410	440	520	228	60	77	Tr440x5	-	65	H3088	HML88	MSL88
	440	520	228	60	77	Tr440x5	M8	65	OH3088	HML88	MSL88
	440	520	228	60	77	Tr440x5	M8	65	OH3088H	HML88	MSL88
	440	520	228	60	77	Tr440x5	M8	65	OH3088B	HML88	MSL88
	440	520	228	60	77	Tr440x5	M8	65	OH3088HB	HML88	MSL88
	440	580	307	70	90	Tr440x5	-	95	H3188	HM88	MS88
	440	580	307	70	90	Tr440x5	M8	95	OH3188	HM88	MS88
	440	580	307	70	90	Tr440x5	M8	95	OH3188H	HM88	MS88
	440	580	307	70	90	Tr440x5	M8	95	OH3188B	HM88	MS88
	440	580	307	70	90	Tr440x5	M8	95	OH3188HB	HM88	MS88
430	460	540	234	60	77	Tr460x5	-	71	H3092	HML92	MSL92
	460	540	234	60	77	Tr460x5	M8	71	OH3092	HML92	MSL92
	460	540	234	60	77	Tr460x5	M8	71	OH3092H	HML92	MSL92
	460	540	234	60	77	Tr460x5	M8	71	OH3092B	HML92	MSL92
	460	540	234	60	77	Tr460x5	M8	71	OH3092HB	HML92	MSL92
	460	580	326	75	95	Tr460x5	-	119	H3192	HM92	MS92
	460	580	326	75	95	Tr460x5	M8	119	OH3192	HM92	MS92
	460	580	326	75	95	Tr460x5	M8	119	OH3192H	HM92	MS92
	460	580	326	75	95	Tr460x5	M8	119	OH3192B	HM92	MS92
	460	580	326	75	95	Tr460x5	M8	119	OH3192HB	HM92	MS92

ADAPTER SLEEVES ZVL SLOVAKIA, a. s.

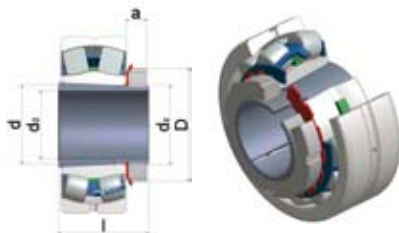

d0	DIMENSIONS mm							WEIGHT kg	SLEEVE DESIGNATION INCL. NUT AND LOCKING	APPROPRIATE COMPONENTS		
	d	D	l	a	a1	dz	dz1			NUT	WASHER	
450	480	560	237	60	77	Tr480x5	-	75	H3096	HML96	MSL96	
	480	560	237	60	77	Tr480x5	M8	75	OH3096H	HML96	MSL96	
	480	560	237	60	77	Tr480x5	M8	75	OH3096HB	HML96	MSL96	
	480	560	237	60	77	Tr480x5	M8	75	OH3096HB	HML96	MSL96	
	480	620	335	75	95	Tr480x5	-	135	H3196	HM96	MS96	
	480	620	335	75	95	Tr480x5	M8	135	OH3196H	HM96	MS96	
	480	620	335	75	95	Tr480x5	M8	135	OH3196HB	HM96	MS96	
	480	620	335	75	95	Tr480x5	M8	135	OH3196HB	HM96	MS96	
	470	500	580	247	68	85	Tr500x5	-	82	H30/500	HML/500	MSL/500
		500	580	247	68	85	Tr500x5	M8	82	OH30/500H	HML/500	MSL/500
500		580	247	68	85	Tr500x5	M8	82	OH30/500HB	HML/500	MSL/500	
500		580	247	68	85	Tr500x5	M8	82	OH30/500HB	HML/500	MSL/500	
500		630	356	80	100	Tr500x5	-	145	H31/500	HM/500	MS/500	
500		630	356	80	100	Tr500x5	M8	145	OH31/500H	HM/500	MS/500	
500		630	356	80	100	Tr500x5	M8	145	OH31/500HB	HM/500	MS/500	
500		630	356	80	100	Tr500x5	M8	145	OH31/500HB	HM/500	MS/500	
500		530	630	265	68	90	Tr530x6	-	105	H30/530	HML/530	MSL/530
		530	630	265	68	90	Tr530x6	M8	105	OH30/530H	HML/530	MSL/530
	530	630	265	68	90	Tr530x6	M8	105	OH30/530HB	HML/530	MSL/530	
	530	630	265	68	90	Tr530x6	M8	105	OH30/530HB	HML/530	MSL/530	
	530	630	265	68	90	Tr530x6	M8	105	OH30/530HB	HML/530	MSL/530	

Note:

- dz1 - thread size for hydraulic hose connection
- a1 - width of KM nut including locking screw



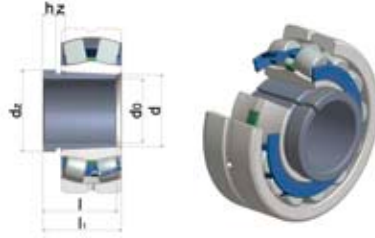

DIMENSIONS mm							WEIGHT kg	SLEEVE DESIGNATION	APPROPRIATE COMPONENTS
d0	d	l	l1	dz	h	dz1			NUT
35	40	25	27	M45x1,5	6		0,08	AH208	KM9
	40	29	32	M45x1,5	6		0,09	AH308	KM9
	40	40	43	M45x1,5	7		0,13	AH2308	KM9
40	45	26	29	M50x1,5	6		0,1	AH209	KM10
	45	31	34	M50x1,5	6		0,12	AH309	KM10
	45	44	47	M50x1,5	7		0,16	AH2309	KM10
45	50	28	31	M55x2	7		0,12	AH210	KM11
	50	35	38	M55x2	7		0,13	AH310	KM11
	50	50	53	M55x2	9		0,19	AHX2310	KM11
50	55	29	32	M60x2	7		0,16	AH211	KM12
	55	37	40	M60x2	7		0,17	AH311	KM12
	55	54	57	M60x2	9		0,26	AHX2311	KM12
55	60	32	35	M65x2	8		0,17	AH212	KM13
	60	40	43	M65x2	8		0,19	AH312	KM13
	60	58	61	M65x2	11		0,3	AHX2312	KM13
60	65	35	38	M70x2	8		0,19	AH213	KM14
	65	42	45	M70x2	8		0,22	AH313	KM14
	65	61	64	M70x2	12		0,36	AH2313	KM14
65	70	37	38	M75x2	8		0,2	AH214	KM15
	70	43	47	M75x2	8		0,24	AH314	KM15
	70	64	68	M75x2	12		0,42	AHX2314	KM15
70	75	37	38	M80x2	8		0,25	AH215	KM16
	75	45	49	M80x2	8		0,29	AH315	KM16
	75	68	72	M80x2	12		0,48	AHX2315	KM16
75	80	39	41	M90x2	8		0,3	AH216	KM18
	80	48	52	M90x2	8		0,37	AH316	KM18
	80	71	75	M90x2	12		0,57	AHX2316	KM18
80	85	39	41	M95x2	9		0,37	AH217	KM19
	85	52	56	M95x2	9		0,43	AHX317	KM19
	85	74	78	M95x2	13		0,65	AHX2317	KM19
85	90	40	44	M100x2	9		0,43	AH218	KM20
	90	53	57	M100x2	9		0,46	AHX318	KM20
	90	79	83	M100x2	14		0,76	AHX2318	KM20
	90	63	67	M100x2	10		0,57	AHX3218	KM20
90	95	43	47	M105x2	10		0,49	AH219	KM21

WITHDRAWAL SLEEVES ZVL SLOVAKIA, a. s.

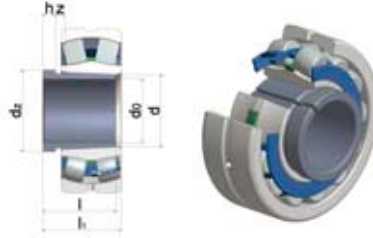

DIMENSIONS mm							WEIGHT kg	SLEEVE DESIGNATION	APPROPRIATE COMPONENTS
d0	d	l	l1	dz	h	dz1			NUT
90	95	57	61	M105x2	10		0,54	AHX319	KM21
	95	85	89	M105x2	16		0,9	AHX2319	KM21
95	100	45	49	M110x2	10		0,53	AH220	KM22
	100	59	63	M110x2	10		0,58	AHX320	KM22
	100	90	94	M110x2	16		1	AHX2320	KM22
	100	64	68	M110x2	11		0,66	AHX3120	KM22
	100	73	77	M110x2	11		0,76	AHX3220	KM22
105	110	47	51	M120x2	12		0,63	AH222	KM24
	110	63	67	M120x2	12		0,77	AHX322	KM24
	110	68	72	M120x2	11		0,76	AHX3122	KM24
	110	82	86	M120x2	11		1	AHX3222	KM24
115	120	50	54	M130x2	12		0,7	AH224	KM26
	120	60	64	M130x2	13		0,73	AHX3024	KM26
	120	75	79	M130x2	12		0,94	AHX3124	KM26
	120	90	94	M130x2	13		1,3	AHX3224	KM26
	120	105	109	M130x2	17		1,55	AHX2324	KM26
	120	73	82	M125x2	13		0,7	AH24024	KM25
	120	93	102	M130x2	13		1	AH24124	KM26
125	130	53	57	M140x2	12		0,82	AH226	KM28
	130	74	78	M140x2	14		1,03	AHX326	KM28
	130	115	119	M145x2	19		2	AHX2326	KM29
	130	67	71	M140x2	14		0,91	AHX3026	KM28
	130	78	82	M140x2	12		1,1	AHX3126	KM28
	130	98	102	M145x2	15		1,55	AHX3226	KM29
	130	83	93	M135x2	14		0,88	AH24026	KM27
	130	94	104	M140x2	14		1,15	AH24126	KM28
135	140	56	61	M150x2	13		1	AH228	KM30
	140	77	82	M150x2	14		1,15	AHX328	KM30
	140	125	130	M155x2	20		2,35	AHX2328	KM31
	140	68	73	M150x2	14		1	AHX3028	KM30
	140	83	88	M150x2	14		1,3	AHX3128	KM30
	140	104	109	M155x2	15		1,85	AHX3228	KM31
	140	83	93	M145x2	14		0,95	AH24028	KM29
	140	99	109	M150x2	14		1,30	AH24128	KM30
145	150	72	77	M160x3	15		1,15	AHX3030	KM32
	150	96	101	M160x3	15		1,70	AHX3130	KM32
	150	114	119	M160x3	17		2,10	AHX3230	KM32
	150	135	140	M160x3	24		2,75	AHX2330	KM32
	150	90	101	M155x2	15		1,05	AH24030	KM31
150	115	126	M160x3	15		1,55	AH24130	KM32	



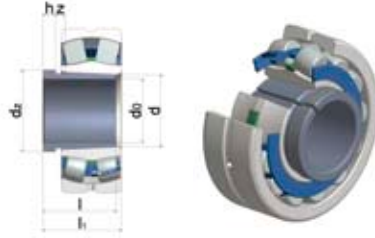

DIMENSIONS mm							WEIGHT kg	SLEEVE DESIGNATION	APPROPRIATE COMPONENTS
d0	d	l	l1	dz	h	dz1			NUT
150	160	77	82	M170x3	16		2,00	AH3032	KM34
	160	103	108	M170x3	16		3,00	AH3132	KM34
	160	124	130	M170x3	20		3,70	AH3232	KM34
	160	140	146	M170x3	24		4,35	AH2332	KM34
	160	95	106	M170x3	15		2,30	AH24032	KM34
	160	124	135	M170x3	15		3,00	AH24132	KM34
160	170	69	74	M180x3	16		2,21	AH234	KM36
	170	93	98	M190x3	17		3,19	AH334	KM38
	170	146	152	M190x3	24		5,25	AH2334	KM38
	170	85	90	M180x3	17		2,45	AH3034	KM36
	170	104	109	M190x3	16		3,45	AH3134	KM38
	170	134	140	M190x3	24		4,80	AH3234	KM38
	170	106	117	M180x3	16		2,70	AH24034	KM36
	170	125	136	M180x3	16		3,25	AH24134	KM36
170	180	69	74	M190x3	16		2,34	AH236	KM38
	180	105	110	M200x3	17		3,75	AH2236	KM40
	180	154	160	M200x3	26		6,05	AH2336	KM40
	180	92	98	M190x3	17		2,80	AH3036	KM38
	180	116	122	M200x3	19		4,25	AH3136	KM40
	180	140	146	M205x3	24		5,25	AH3236	KM40
	180	116	127	M190x3	16		3,20	AH24036	KM38
	180	134	145	M190x3	16		3,75	AH24136	KM38
180	190	96	102	M200x3	18		3,30	AH3038	KM40
	190	112	117	M200x3	18		3,90	AH2238	KM40
	190	125	131	M200x3	20		4,50	AH3138	KM40
	190	145	152	M200x3	25		5,40	AH3238	KM40
	190	160	167	M200x3	26		6,10	AH2338	KM40
	190	118	131	M200x3	18		3,55	AH24038	KM40
	190	146	159	M200x3	18		4,45	AH24138	KM40
190	200	102	108	Tr210x4	19		3,70	AH3040	HM42
	200	134	140	Tr220x4	21		5,65	AH3140	HM44
	200	153	160	Tr220x4	25		6,60	AH3240	HM44
	200	170	177	Tr220x4	30		7,60	AH2340	HM44
	200	127	140	Tr210x4	18		4,00	AH24040	HML42
	200	158	171	Tr210x4	18		5,05	AH24140	HML42
200	220	111	117	Tr230x4	20	-	7,40	AH3044	HML46
	220	111	117	Tr230x4	20	G1/8	7,40	AOH3044	HM46
	220	145	151	Tr240x4	23	-	9,30	AH3144	HM48
	220	145	151	Tr240x4	23	G1/4	9,30	AOH3144	HM48
	220	181	189	Tr240x4	30	-	13,50	AH2344	HM48
	220	181	189	Tr240x4	30	G1/4	13,50	AOH2344	HM48
	220	138	152	Tr230x4	20	-	7,45	AH24044	HML46

WITHDRAWAL SLEEVES ZVL SLOVAKIA, a. s.

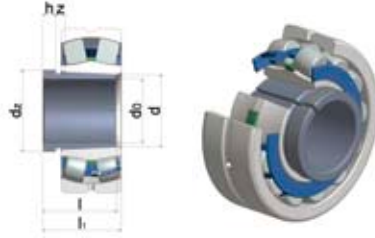

DIMENSIONS mm							WEIGHT kg	SLEEVE DESIGNATION	APPROPRIATE COMPONENTS
d0	d	l	l1	dz	h	dz1			NUT
200	220	138	152	Tr230x4	20	G1/8	7,45	AH24044	HML46
	220	170	184	Tr230x4	20	-	10,00	AH24144	HML46
	220	170	184	Tr230x4	20	G1/8	10,00	AH24144	HML46
220	240	116	123	Tr260x4	21	-	7,95	AH3048	HM52
	240	116	123	Tr260x4	21	G1/4	7,95	AOH3048	HM52
	240	154	161	Tr260x4	25	-	12,00	AH3148	HM52
	240	154	161	Tr260x4	25	G1/4	12,00	AOH3148	HM52
	240	189	197	Tr260x4	30	-	14,00	AH2348	HM52
	240	189	197	Tr260x4	30	G1/4	14,00	AOH2348	HM52
	240	138	153	Tr250x4	20	-	8,05	AH24048	HML50
	240	138	153	Tr250x4	20	G1/8	8,05	AOH24048	HML50
	240	180	195	Tr260x4	20	-	11,50	AH24148	HM52
240	180	195	Tr260x4	20	G1/4	11,50	AOH24148	HM52	
240	260	128	135	Tr280x4	23	-	9,60	AH3052	HML56
	260	128	135	Tr280x4	23	G1/4	9,60	AOH3052	HML56
	260	155	161	Tr290x4	23	-	12,50	AH2252	HM58
	260	155	161	Tr290x4	23	G1/4	12,50	AOH2252	HM58
	260	172	179	Tr290x4	26	-	16,00	AH3152	HM58
	260	172	179	Tr290x4	26	G1/4	16,00	AOH3152	HM58
	260	205	213	Tr290x4	30	-	17,50	AH2352	HM58
	260	205	213	Tr290x4	30	G1/4	17,50	AOH2352	HM58
	260	162	178	Tr270x4	22	-	10,50	AH24052	HM54
	260	162	178	Tr270x4	22	G1/4	10,50	AOH24052	HM54
	260	202	218	Tr280x4	22	-	14,00	AH24152	HM56
260	202	218	Tr280x4	22	G1/4	14,00	AOH24152	HM56	
260	280	131	139	Tr300x4	24	-	11,00	AH3056	HML60
	280	131	139	Tr300x4	24	G1/4	11,00	AOH3056	HML60
	280	155	163	Tr300x4	24	-	15,00	AH2256	HM60
	280	155	163	Tr300x4	24	G1/4	15,00	AOH2256	HM60
	280	175	183	Tr300x4	28	-	17,00	AH3156	HM60
	280	175	183	Tr300x4	28	G1/4	17,00	AOH3156	HM60
	280	212	220	Tr300x4	30	-	21,50	AH2356	HM60
	280	212	220	Tr300x4	30	G1/4	21,50	AOH2356	HM60
	280	162	179	Tr300x4	22	-	13,50	AH24056	HM60
	280	162	179	Tr300x4	22	G1/8	13,50	AOH24056	HM60
	280	202	219	Tr300x4	22	-	15,00	AH24156	HM60
280	202	219	Tr300x4	22	G1/4	15,00	AOH24156	HM60	
280	300	145	153	Tr320x5	26	-	13,00	AH3060	HML64
	300	145	153	Tr320x5	26	G1/4	13,00	AOH3060	HML64
	300	170	178	Tr330x5	26	-	18,00	AH2260	HM66
	300	170	178	Tr330x5	26	G1/4	18,00	AOH2260	HM66
	300	192	200	Tr330x5	30	-	19,00	AH3160	HM66
	300	192	200	Tr330x5	30	G1/4	19,00	AOH3160	HM66



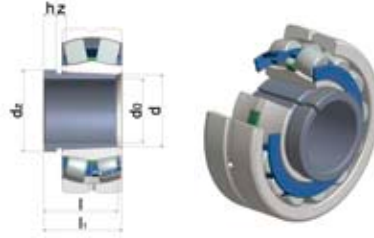

DIMENSIONS mm							WEIGHT kg	SLEEVE DESIGNATION	APPROPRIATE COMPONENTS
d0	d	l	l1	dz	h	dz1			NUT
280	300	228	236	Tr330x5	34	-	23.50	AH3260	HM66
	300	228	236	Tr330x5	34	G1/4	23.50	AOH3260	HM66
	300	184	202	Tr310x5	24	-	14.00	AH24060	HM62
	300	184	202	Tr310x5	24	G1/4	14.00	AOH24060	HM62
	300	224	242	Tr320x5	24	-	18.50	AH24160	HM64
	300	224	242	Tr320x5	24	G1/4	18.50	AOH24160	HM64
300	320	149	157	Tr340x5	27	-	16.50	AH3064	HML68
	320	149	157	Tr340x5	27	G1/4	16.50	AOH3064	HML68
	320	180	190	Tr340x5	27	-	20.00	AH2264	HM68
	320	180	190	Tr340x5	27	G1/4	20.00	AOH2264	HM68
	320	209	217	Tr340x5	31	-	24.50	AH3164	HM68
	320	209	217	Tr340x5	31	G1/4	24.50	AOH3164	HM68
	320	246	254	Tr340x5	36	-	27.50	AH3264	HM68
	320	246	254	Tr340x5	36	G1/4	27.50	AOH3264	HM68
	320	184	202	Tr340x5	24	-	18.00	AH24064	HM68
	320	184	202	Tr340x5	24	G1/4	18.00	AOH24064	HM68
	320	242	260	Tr340x5	24	-	20.50	AH24164	HM68
	320	242	260	Tr340x5	24	G1/4	20.50	AOH24164	HM68
320	340	162	171	Tr365x5	28	-	17.50	AH3068	HML68
	340	162	171	Tr365x5	28	G1/4	17.50	AOH3068	HML68
	340	225	234	Tr370x5	33	-	26.50	AH3168	HM74
	340	225	234	Tr370x5	33	G1/4	26.50	AOH3168	HM74
	340	264	273	Tr370x5	38	-	32.00	AH3268	HM74
	340	264	273	Tr370x5	38	G1/4	32.00	AOH3268	HM74
	340	206	225	Tr360x5	26	-	18.00	AH24068	HM72
	340	206	225	Tr360x5	26	G1/4	18.00	AOH24068	HM72
	340	269	288	Tr360x5	26	-	25.50	AH24168	HM72
	340	269	288	Tr360x5	26	G1/4	25.50	AOH24168	HM72
340	360	167	176	Tr385x5	30	-	19.00	AH3072	HML77
	360	167	176	Tr385x5	30	G1/4	19.00	AOH3072	HML77
	360	229	238	Tr400x5	35	-	30.00	AH3172	HM80
	360	229	238	Tr400x5	35	G1/4	30.00	AOH3172	HM80
	360	274	283	Tr400x5	40	-	33.00	AH3272	HM80
	360	274	283	Tr400x5	40	G1/4	33.00	AOH3272	HM80
	360	206	226	Tr380x5	26	-	20.00	AH24072	HM76
	360	206	226	Tr380x5	26	G1/4	20.00	AOH24072	HM76
	360	269	289	Tr380x5	26	-	26.00	AH24172	HM76
	360	269	289	Tr380x5	26	G1/4	26.00	AOH24172	HM76
360	380	170	180	Tr400x5	31	-	22.50	AH3076	HML80
	380	170	180	Tr400x5	31	G1/4	22.50	AOH3076	HML80
	380	232	242	Tr400x5	36	-	33.00	AH3176	HM80
	380	232	242	Tr400x5	36	G1/4	33.00	AOH3176	HM80
	380	284	294	Tr400x5	42	-	42.00	AH3276	HM80

WITHDRAWAL SLEEVES ZVL SLOVAKIA, a. s.

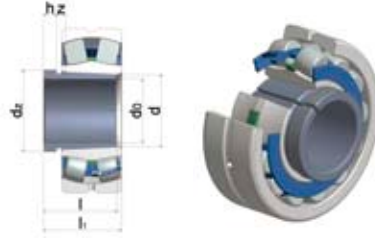

DIMENSIONS mm							WEIGHT kg	SLEEVE DESIGNATION	APPROPRIATE COMPONENTS
d0	d	l	l1	dz	h	dz1			NUT
360	380	284	294	Tr400x5	42	G1/4	42.00	AOH3276	HM80
	380	208	228	Tr400x5	28	-	23.50	AH24076	HM80
	380	208	228	Tr400x5	28	G1/4	23.50	AOH24076	HM80
	380	271	291	Tr400x5	28	-	31.00	AH24176	HM80
	380	271	291	Tr400x5	28	G1/4	31.00	AOH24176	HM80
380	400	183	193	Tr430x5	33	-	27.00	AH3080	HML86
	400	183	193	Tr430x5	33	G1/4	27.00	AOH3080	HML86
	400	240	250	Tr440x5	38	-	39.50	AH3180	HM88
	400	240	250	Tr440x5	38	G1/4	39.50	AOH3180	HM88
	400	303	312	Tr440x5	44	-	51.50	AH3280	HM88
	400	303	312	Tr440x5	44	G1/4	51.50	AOH3280	HM88
	400	228	248	Tr420x5	28	-	27.00	AH24080	HM84
	400	228	248	Tr420x5	28	G1/4	27.00	AOH24080	HM84
	400	278	298	Tr420x5	28	-	35.00	AH24180	HM84
	400	278	298	Tr420x5	28	G1/4	35.00	AOH24180	HM84
400	420	186	196	Tr450x5	34	-	29.00	AH3084	HML90
	420	186	196	Tr450x5	34	G1/4	29.00	AOH3084	HML90
	420	266	276	Tr460x5	40	-	46.00	AH3184	HM92
	420	266	276	Tr460x5	40	G1/4	46.00	AOH3184	HM92
	420	321	331	Tr460x5	46	-	59.00	AH3284	HM92
	420	321	331	Tr460x5	46	G1/4	59.00	AOH3284	HM92
	420	230	252	Tr440x5	30	-	29.00	AH24084	HM88
	420	230	252	Tr440x5	30	G1/4	29.00	AOH24084	HM88
	420	310	332	Tr440x5	30	-	39.00	AH24184	HM88
420	310	332	Tr440x5	30	G1/4	39.00	AOH24184	HM88	
420	440	194	205	Tr460x5	35	-	31.00	AH3088	HML92
	440	194	205	Tr460x5	35	G1/4	31.00	AOH3088	HML92
	440	270	281	Tr460x5	42	-	46.00	AH3188	HM92
	440	270	281	Tr460x5	42	G1/4	46.00	AOH3188	HM92
	440	330	341	Tr460x5	48	-	64.50	AH3288	HM92
	440	330	341	Tr460x5	48	G1/4	64.50	AOH3288	HM92
	440	242	264	Tr460x5	30	-	32.00	AH24088	HM92
	440	242	264	Tr460x5	30	G1/4	32.00	AOH24088	HM92
	440	310	332	Tr460x5	30	-	45.50	AH24188	HM92
	440	310	332	Tr460x5	30	G1/4	45.50	AOH24188	HM92
440	460	202	213	Tr490x5	37	-	35.00	AH3092	HML98
	460	202	213	Tr490x5	37	G1/4	35.00	AOH3092	HML98
	460	285	296	Tr510x5	43	-	58.00	AH3192	HM510
	460	285	296	Tr510x5	43	G1/4	58.00	AOH3192	HM510
	460	349	360	Tr510x5	50	-	75.50	AH3292	HM510
	460	349	360	Tr510x5	50	G1/4	75.50	AOH3292	HM510
	460	250	273	Tr480x5	32	-	34.50	AH24092	HML96
	460	250	273	Tr480x5	32	G1/4	34.50	AOH24092	HML96



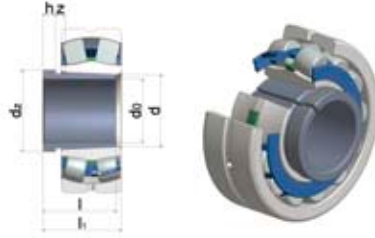

DIMENSIONS mm							WEIGHT kg	SLEEVE DESIGNATION	APPROPRIATE COMPONENTS
d0	d	l	l1	dz	h	dz1			NUT
440	460	332	355	Tr480x5	32	-	50,00	AH24192	HM96
	460	332	355	Tr480x5	32	G1/4	50,00	AOH24192	HM96
460	480	205	217	Tr52x5	38	-	39,00	AHX3096	HML/520
	480	205	217	Tr52x5	38	G1/4	39,00	AOHX3096	HML/520
	480	295	307	Tr530x6	45	-	63,00	AHX3196	HM/530
	480	295	307	Tr530x6	45	G1/4	63,00	AOHX3196	HM/530
	480	364	376	Tr530x5	52	-	82,50	AHX3296	HM/530
	480	364	376	Tr530x5	52	G1/4	82,50	AHX3296	HM/530
	480	250	273	Tr500x5	32	-	36,50	AH24096	HML/550
	480	250	273	Tr500x5	32	G1/4	36,50	AOH24096	HML/550
	480	340	340	Tr500x5	32	-	51,50	AH24196	HM/550
480	340	340	Tr500x5	32	G1/4	51,50	AOH24196	HM/550	
480	500	209	221	Tr530x6	40	-	41,00	AHX30/500	HML/530
	500	209	221	Tr530x6	40	G1/4	41,00	AOHX30/500	HML/530
	500	313	325	Tr530x6	47	-	66,50	AHX31/500	HM/530
	500	313	325	Tr530x6	47	G1/4	66,50	AOHX31/500	HM/530
	500	393	405	Tr530x6	54	-	89,50	AHX32/500	HM/530
	500	393	405	Tr530x6	54	G1/4	89,50	AOHX32/500	HM/530
	500	253	276	Tr530x6	35	-	43,00	AH240/500	HM/530
	500	253	276	Tr530x6	35	G1/4	43,00	AOH240/500	HM/530
	500	360	383	Tr530x6	35	-	63,00	AH241/500	HM/530
500	360	383	Tr530x6	35	G1/4	63,00	AOH241/500	HM/530	
500	530	230	242	Tr560x6	45	-	63,50	AH30/530	HML/560
	530	230	242	Tr560x6	45	G1/4	63,50	AOH30/530	HML/560
	530	325	337	Tr560x6	53	-	93,50	AH31/530	HM/560
	530	325	337	Tr560x6	53	G1/4	93,50	AOH31/530	HM/560
	530	412	424	Tr560x6	57	-	142,00	AH32/530	HM/560
	530	412	424	Tr560x6	57	G1/4	142,00	AOH32/530	HM/560
	530	285	309	Tr560x6	35	-	64,50	AH240/530	HM/560
	530	285	309	Tr560x6	35	G1/4	64,50	AOH240/530	HM/560
	530	370	394	Tr560x6	35	-	92,00	AH241/530	HM/560
530	370	394	Tr560x6	35	G1/4	92,00	AOH241/530	HM/560	

LOCK NUTS ZVL SLOVAKIA, a. s.

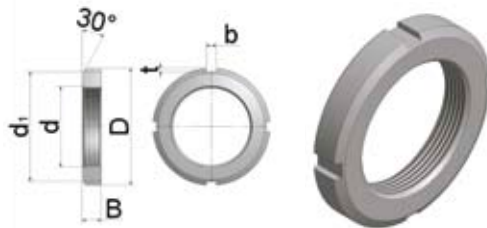

DIMENSIONS mm						WEIGHT kg	SLEEVE DESIGNATION	APPROPRIATE COMPONENTS	
d	d1	D	B	b	t			LOCKING WASHER	
M15x1	21	25	5	4	2	-	0,012	KM2	MB2
M17x1	24	28	5	4	2	-	0,012	KM3	MB3
M20x1	26	32	6	4	2	-	0,02	KM4	MB4
M25x1,5	32	38	7	5	2	-	0,028	KM5	MB5
M30x1,5	38	45	7	5	2	-	0,038	KM6	MB6
M35x1,5	44	52	8	5	2	-	0,058	KM7	MB7
M40x1,5	50	58	9	6	2,5	-	0,078	KM8	MB8
M45x1,5	56	65	10	6	2,5	-	0,11	KM9	MB9
M50x1,5	61	70	11	6	2,5	-	0,14	KM10	MB10
M55x2	67	75	11	7	3	-	0,15	KM11	MB11
M60x2	73	80	11	7	3	-	0,16	KM12	MB12
M65x2	79	85	12	7	3	-	0,19	KM13	MB13
M70x2	85	92	12	8	3,5	-	0,22	KM14	MB14
M75x2	90	98	13	8	3,5	-	0,27	KM15	MB15
M80x2	95	105	15	8	3,5	-	0,36	KM16	MB16
M85x2	102	110	16	8	3,5	-	0,42	KM17	MB17
M90x2	108	120	16	10	4	-	0,51	KM18	MB18
M95x2	113	125	17	10	4	-	0,58	KM19	MB19
M100x2	120	130	18	10	4	-	0,68	KM20	MB20
M105x2	126	140	18	12	5	-	0,81	KM21	MB21
M110x2	133	145	19	12	5	-	0,89	KM22	MB22
M115x2	137	150	19	12	5	-	0,91	KM23	MB23
M120x2	135	145	20	12	5	-	0,69	KML24	MBL24
	138	155	20	12	5	-	0,98	KM24	MB24
M125x2	148	160	21	12	5	-	1,1	KM25	MB25
M130x2	145	155	21	12	5	-	0,84	KML26	MBL26
	149	165	21	12	5	-	1,2	KM26	MB26
M135x2	160	175	22	14	6	-	1,4	KM27	MB27



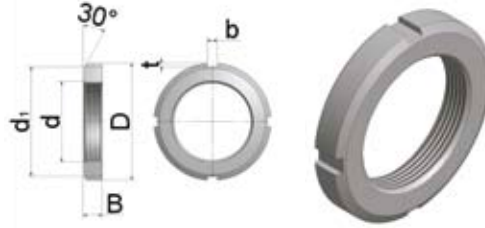

DIMENSIONS mm							WEIGHT kg	SLEEVE DESIGNATION	APPROPRIATE COMPONENTS
d	d1	D	B	b	t				LOCKING WASHER
M140x2	155	165	22	12	5	-	0,92	KML28	MBL28
	160	180	22	14	6	-	1,4	KM28	MB28
M145x2	171	190	24	14	6	-	1,85	KM29	MB29
M150x2	170	180	24	14	5	-	1,3	KML30	MBL30
	171	195	24	14	6	-	1,85	KM30	MB30
M155x3	182	200	25	16	7	-	2,05	KM31	MB31
M160x3	180	190	25	14	5	-	1,4	KML32	MBL32
	182	210	25	16	7	-	2,25	KM32	MB32
M165x3	195	210	26	16	7	-	2,3	KM33	MB33
M170x3	190	200	26	16	5	-	1,6	KML34	MBL34
	193	220	26	16	7	-	2,55	KM34	MB34
M180x3	200	210	27	16	5	-	1,8	KML36	MBL36
	203	230	27	18	8	-	2,7	KM36	MB36
M190x3	210	220	28	16	5	-	1,9	KML38	MBL38
	214	240	28	18	8	-	3	KM38	BM38
M200x3	222	240	29	18	8	-	2,6	KML40	MBL40
	226	250	29	18	8	-	3,3	KM40	MB40
Tr205x4	232	250	30	18	8	-	3,2	HML41	MBL41
Tr210x4	238	270	30	20	10	-	5,1	HML42	MSL42
Tr215x4	242	260	30	20	9	-	3,3	HML43	MSL43
Tr220x4	242	260	30	20	9	M6	3,4	HML44	MSL44
Tr240x4	270	290	34	20	10	M8	4,85	HML48	MSL48
Tr260x4	290	310	34	20	10	M8	5,15	HML52	MSL52
Tr280x4	310	330	38	24	10	M8	5,5	HML56	MSL56
Tr300x4	336	360	42	24	12	M8	7,25	HML60	MSL60
	340	380	40	24	12	M10	12	HM60	MS60
Tr 310x4	350	390	42	24	12	-	13	HM62	MS62
Tr320x5	356	390	42	24	12	M8	10,5	HML64	MSL64
	360	400	42	24	12	M10	13,5	HM64	MS64
Tr330x5	380	420	52	28	15	-	20	HM66	MS66
Tr340x5	376	400	45	24	12	M8	13	HML68	MSL68
	400	440	55	28	15	M12	23,2	HM68	MS68

LOCK NUTS ZVL SLOVAKIA, a. s.

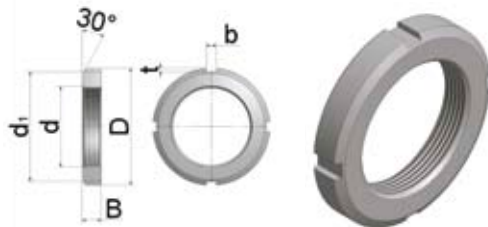

DIMENSIONS mm						WEIGHT kg	SLEEVE DESIGNATION	APPROPRIATE COMPONENTS	
d	d1	D	B	b	t			LOCKING WASHER	
Tr345x5	384	410	45	28	13	-	13	HML69	MSL69
Tr350x5	410	450	55	28	15	-	25	HM70	MS70
Tr360x5	420	460	58	28	15	-	27.5	HM72	MS72
Tr370x5	430	470	58	28	15	-	28	HM74	MS74
Tr385x5	422	450	48	28	14	-	15	HML77	MSL77
Tr400x5	470	520	62	32	18	-	40	HM80	MS80
Tr410x5	452	480	52	32	14	-	19	HML82	MSL82
Tr420x5	490	540	70	32	18	-	47	HM84	MS84
Tr430x5	472	500	52	32	14	-	20	HML86	MSL86
Tr440x5	510	560	70	36	20	-	48.5	HM88	MS88
Tr450x5	490	520	60	32	15	-	24	HML90	MSL90
Tr460x5	510	540	60	32	15	-	28	HML92	MSL92
Tr480x5	530	560	60	36	15	M12	29.5	HML96	MSL96
	560	620	75	36	20	M16	62.5	HM96	MS96
Tr490x5	550	580	60	36	15	-	34	HML98	MSL98
Tr500x5	550	580	68	36	15	M12	35	HML500	MSL500
	580	630	80	40	23	M16	64	HM500	MS500
Tr510x6	590	650	80	40	23	-	79	HM510	MS510
Tr520x6	570	600	68	36	15	-	37	HML520	MSL520
Tr530x6	590	630	68	40	20	M16	50	HML530	MSL530
	610	670	80	40	23	M20	83	HM530	MS530
Tr540x6	590	630	68	40	20	-	47	HML540	MSL540
Tr550x6	640	700	80	40	23	-	86	HM550	MS550
Tr560x6	610	650	75	40	20	M16	51	HML560	MSL560
	650	710	85	45	25	M20	97	HM560	MS560



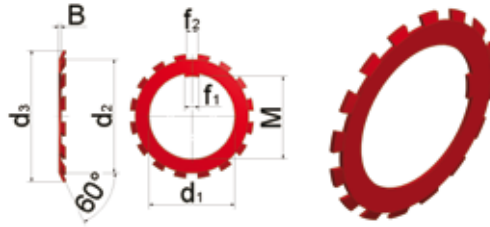

DIMENSIONS mm							WEIGHT kg	DESIGNATION
d1	d2	d3	M	B	f1	f2	100ks/kg	LOCKING WASHER
10	13,5	21	8,5	1	3	3	0,131	MB0
12	17	25	10,5	1	3	3	0,2	MB1
15	21	28	13,5	1	4	4	0,26	MB2
17	24	32	15,5	1	4	4	0,32	MB3
20	26	36	18,5	1	4	4	0,35	MB4
25	32	42	23	1,25	5	5	0,64	MB5
30	38	49	27,5	1,25	5	5	0,78	MB6
35	44	57	32,5	1,25	5	5	1,05	MB7
40	50	62	37,5	1,25	6	6	1,24	MB8
45	56	69	42,5	1,25	6	6	1,52	MB9
50	61	74	47,5	1,25	6	6	1,6	MB10
55	67	81	52,5	1,5	7	8	1,96	MB11
60	73	86	57,5	1,5	7	8	2,53	MB12
65	79	92	62,5	1,5	7	8	2,9	MB13
70	85	98	66,5	1,5	8	8	3,34	MB14
75	90	104	71,5	1,5	8	8	3,56	MB15
80	95	112	76,5	1,8	10	8	4,64	MB16
85	102	119	81,5	1,8	10	8	5,24	MB17
90	108	126	86,5	1,8	10	10	0,15	MB18
95	113	133	91,5	1,8	10	10	6,7	MB19
100	120	140	96,5	1,8	12	10	7,65	MB20
105	126	145	100,5	1,8	12	12	8,26	MB21
110	133	154	105,5	1,8	12	12	9,4	MB22
115	137	159	110,5	2	12	12	10,8	MB23
120	135	148	115	2	14	12	7	MBL24
125	138	164	115	2	12	14	10,5	MB24
125	148	170	120	2	12	14	11,8	MB25
130	145	161	125	2	12	14	8	MBL26
130	149	175	125	2	12	14	11,8	MB26
135	160	185	130	2	14	14	14,4	MB27
140	155	172	135	2	14	16	9	MBL28
140	160	192	135	2	14	16	14,4	MB28
145	172	202	140	2	14	16	16,8	MB29
150	170	189	145	2	14	16	10	MBL30
150	171	205	145	2	14	16	15,5	MB30
155	182	212	147,5	2,5	16	16	20,9	MB31
160	180	199	154	2,5	16	18	14	MBL32
160	182	217	154	2,5	16	18	22,2	MB32
165	193	222	157,5	2,5	16	18	24,1	MB33
170	190	209	164	2,5	18	16	17	MBL34
170	193	232	164	2,5	18	16	24,7	MB34
180	200	215	174	2,5	20	16	18	MBL36
180	203	242	174	2,5	20	18	26,8	MB36
190	210	228	184	2,5	20	16	20,5	MBL38
190	214	252	184	2,5	20	18	27,8	MB38
200	222	248	194	2,5	20	18	21,4	MBL40
200	226	262	194	2,5	20	18	29,3	MB40
220	250	292	350	3	22	24	35	MB44
240	270	312	233	3	22	24	45	MB48
260	300	342	253	3	26	28	65	MB52
280	320	362	273	3	26	28	105	MB56

LOCKING WASHERS ZVL SLOVAKIA, a. s.

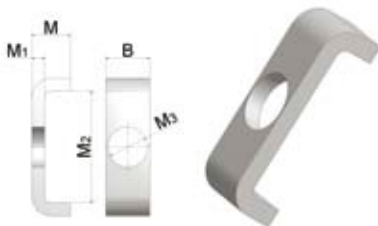

DIMENSIONS mm					WEIGHT	DESIGNATION	WASHER
B	M	M1	M2	M3	kg		
20	12	4	13,5	7	0,022	MSL44	M6X12
	12	4	17,5	9	0,024	MSL48	M8X16
24	12	4	17,5	9	0,03	MSL56	M8X16
	12	4	20,5	9	0,033	MSL60	M8X16
28	15	5	21	9	0,046	MSL64	M8X16
	15	5	20	9	0,051	MSL72	M8X16
	15	5	24	12	0,055	MSL76	M10X20
32	15	5	24	12	0,063	MSL84	M10X20
	15	5	28	14	0,067	MSL88	M12X25
36	15	5	28	14	0,076	MSL96	M12X25
	21	7	28	18	0,15	MSL/530	M16X30
40	21	7	29	18	0,14	MSL/560	M16X30
	21	7	34	18	0,17	MSL/630	M16X30
45	21	7	39	18	0,19	MSL/670	M16X30
	21	7	39	18	0,21	MSL/710	M16X30
55	21	7	39	18	0,23	MSL/750	M16X30
	21	7	44	22	0,26	MSL/850	M20X40
60	21	7	46	22	0,26	MSL/950	M20X40
	21	7	51	22	0,28	MSL/1000	M20X40
20	12	4	22,5	9	0,02	MS44	M8X16
	12	4	25,5	12	0,03	MS52	M8X16
24	12	4	30,5	12	0,04	MS60	M10X20
	15	5	31	12	0,055	MS64	M10X20
28	15	5	38	14	0,069	MS68	M10X20
	15	5	40	14	0,083	MS76	M12X25
32	15	5	45	18	0,089	MS80	M12X25
	15	5	43	18	0,097	MS88	M16X30
36	15	5	53	18	0,11	MS96	M16X30
	15	5	45	18	0,11	MS/500	M16X30
40	21	7	51	22	0,19	MS/530	M16X30
	21	7	54	22	0,22	MS/560	M20X40
50	21	7	61	22	0,27	MS/630	M20X40
	21	7	66	22	0,28	MS/670	M20X40
55	21	7	69	26	0,32	MS/710	M20X40
	21	7	70	26	0,35	MS/750	M24X50
70	21	7	71	26	0,41	MS/850	M24X50
	21	7	76	26	0,41	MS/900	M24X50
	21	7	78	26	0,42	MS/950	M24X50
	21	7	88	26	0,5	MS/1000	M24X50

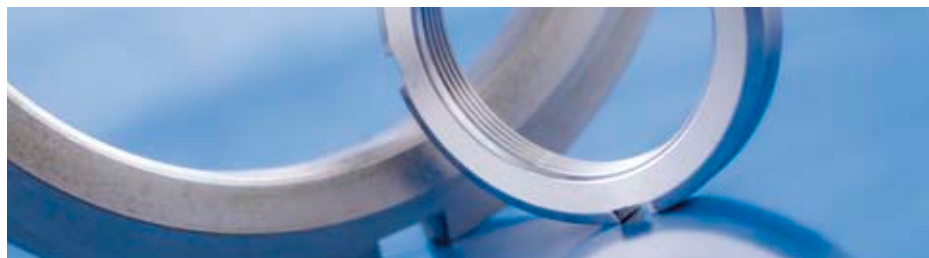



ZVL SLOVAKIA, a. s.
Na stanicu 22, 010 09 Zilina, Slovakia
Tel.: +421 41 707 60 32, Fax: +421 41 707 60 24
sales.zvl@zvlislovakia.sk
www.zvlislovakia.sk