

BEARING CATALOGUE



RKB
BEARING INDUSTRIES
SWITZERLAND

BB

ACBB

CRB

TRB

SRB

TORB

TBB

CRTB

TRTB

SRTB

The Swiss Premium Class Bearing Manufacturer

The RKB Bearing Industries Group is the Swiss manufacturing organization which has been operating in the bearing industry since 1936, with a monthly production capacity exceeding 350 tons of machined steel.

The experience gained over the years provides RKB with the know-how and expertise necessary for the development and manufacture of technological industrial bearings up to 1925 mm outer diameter.

RKB offers reliable cost-effective solutions, with extreme operational flexibility, leading-edge service, huge stock availability, short delivery time and the typical quality of a consistent premium class bearing source. With a worldwide distribution network and exports to more than 50 countries, RKB is globally recognized as *“The Alternative Power”* in the bearing industry.

Publication RKB_BC.Rev01EN

© RKB Europe SA 2019/09

Every care has been taken to ensure the accuracy of the information in the present document but no liability can be accepted for any errors, omissions, losses and damages (direct, indirect, consequential).

Reproduction in whole or in part without our authorization is prohibited.







Table of Contents

Main prefixes and suffixes	4
Ball bearings	9
Ball bearings	12
Deep groove ball bearings.....	12
Angular contact ball bearings	72
Single row angular contact ball bearings.....	72
Double row angular contact ball bearings.....	92
Four-point contact ball bearings.....	108
Cylindrical roller bearings	123
Cylindrical roller bearings.....	126
Single row cylindrical roller bearings.....	126
Single row full complement cylindrical roller bearings.....	170
Double row cylindrical roller bearings.....	190
Double row full complement cylindrical roller bearings	214
Multi row cylindrical roller bearings.....	240
Tapered roller bearings	269
Tapered roller bearings.....	272
Single row tapered roller bearings.....	272
Double row tapered roller bearings	350
Four-row tapered roller bearings.....	396
Spherical roller bearings	471
Spherical roller bearings	472
Toroidal roller bearings	525
Toroidal roller bearings.....	526
Thrust bearings	557
Thrust ball bearings.....	560
Single direction thrust ball bearings.....	560
Double direction thrust ball bearings.....	588
Cylindrical roller thrust bearings	594
Single direction cylindrical roller thrust bearings.....	594
Double direction cylindrical roller thrust bearings.....	614
Tapered roller thrust bearings.....	616
Single direction tapered roller thrust bearings.....	616
Double direction tapered roller thrust bearings.....	630
Spherical roller thrust bearings.....	636
Single direction spherical roller thrust bearings.....	636

Main prefixes and suffixes

Prefixes

GS	Housing washer of cylindrical roller thrust bearings
K	Cylindrical roller and cage thrust assembly
L	Separable bearing ring, including possible loose lips of separable roller bearings. Also, separable bearing rings which consist of several parts
R	Bearing ring with rolling element and cage assembly of separable roller bearings or needle roller bearings
WS	Shaft washer of cylindrical roller thrust bearings

Tab. 1 - Prefixes

Suffixes

Internal design

A...Z 1...n	Modification code to the bearing. Typically placed at the end of the part number, the meaning of these characters is not specifically fixed (e.g. modified internal design or configuration, special production protocol, application optimized version, filled with non-standard grease or other special feature). The actual modification to the original design is specific to the individual bearing and is provided on the related drawing. Combinations of letters and digits are also used (e.g. AC, A2). Sometimes, this type of suffix is preceded by an oblique stroke (e.g. /4)
E/EC	Optimized internal design with reinforced execution and/or increased load ratings
SP	Special or non-standard bearing
AOB	Application optimized bearing

Tab. 2 - Suffixes: internal design

Suffixes

External design

K	Tapered bore, taper 1:12
K30	Tapered bore, taper 1:30
ZB	Optimized roller profile for improved load distribution. It is not necessarily stated in the bearing code

Tab. 3 - Suffixes: external design

Suffixes

Set

DB	Two bearings matched for mounting back-to-back
DF	Two bearings matched for mounting face-to-face
DT	Two bearings matched for mounting in tandem
2x...	Pair of two bearings
3x...	Group of three bearings
SET 2x...	Set of two bearings with possible presence of spacers
SET 3x...	Set of three bearings with possible presence of spacers

Tab. 4 - Suffixes: set

Suffixes	Materials and heat treatments
HB1	Bainite hardened outer and inner ring
HB2	Bainite hardened outer ring
HB3	Bainite hardened inner ring
HB4	Bainite hardened outer and inner ring and rolling elements
HB5	Bainite hardened rolling elements
HB6	Bainite hardened outer ring and rolling elements
HB7	Bainite hardened inner ring and rolling elements
HA1	Case hardened outer and inner ring
HA2	Case hardened outer ring
HA3	Case hardened inner ring
HA4	Case hardened outer and inner ring and rolling elements
HA5	Case hardened rolling elements
HA6	Case hardened outer ring and rolling elements
HA7	Case hardened inner ring and rolling elements

Tab. 5 - Suffixes: materials and heat treatments

Suffixes	Special surface treatments
AWT1	Anti-wear treated outer and inner ring
AWT2	Anti-wear treated outer ring
AWT3	Anti-wear treated inner ring
AWT4	Anti-wear treated outer and inner ring and rolling elements
AWT5	Anti-wear treated rolling elements
AWT6	Anti-wear treated outer ring and rolling elements
AWT7	Anti-wear treated inner ring and rolling elements
PT1	Phosphate treated outer and inner ring
PT2	Phosphate treated outer ring
PT3	Phosphate treated inner ring
PT4	Phosphate treated outer and inner ring and rolling elements
PT5	Phosphate treated rolling elements
PT6	Phosphate treated outer ring and rolling elements
PT7	Phosphate treated inner ring and rolling elements
ACT1	Anti-corrosion treated outer and inner ring
ACT2	Anti-corrosion treated outer ring
ACT3	Anti-corrosion treated inner ring

Tab. 6 - Suffixes: special surface treatments

Suffixes	Dimensional stabilizing
S0	Bearing rings heat stabilized for operating temperatures up to 150 °C (300 °F)
S1	Bearing rings heat stabilized for operating temperatures up to 200 °C (390 °F)
S2	Bearing rings heat stabilized for operating temperatures up to 250 °C (480 °F)
S3	Bearing rings heat stabilized for operating temperatures up to 300 °C (570 °F)

Tab. 7 - Suffixes: dimensional stabilizing

Suffixes	Dimensional and running accuracy, clearance
ABEC1	Approximated to tolerance class P0
ABEC3	Approximated to tolerance class P6
ABEC5	Approximated to tolerance class P5
ST	Special tolerance
C1	Radial internal clearance smaller than C2
C2	Radial internal clearance smaller than Normal
CN	Normal radial internal clearance
C3	Radial internal clearance greater than Normal
C4	Radial internal clearance greater than C3
C5	Radial internal clearance greater than C4
C...S	Special radial internal clearance in a given range of the stated class
C...SL	Special radial internal clearance in the lower part of the stated class (e.g. C4SL = radial internal clearance in the lower part of C4)
C...ST	Special radial internal clearance in the upper part of the stated class (e.g. C4ST = radial internal clearance in the upper part of C4)
C...R	Radial internal clearance between upper part of previous class and lower part of the stated class (e.g. C4R = radial internal clearance between upper part of C3 and lower part of C4)
CS	Special radial internal clearance
P0	Dimensional and running accuracy to ISO tolerance class 0
P5	Dimensional and running accuracy to ISO tolerance class 5
P6	Dimensional and running accuracy to ISO tolerance class 6
P6S	Dimensional and running accuracy between P6 and P5
P51	P5 + C1
P52	P5 + C2
P53	P5 + C3
P54	P5 + C4
P55	P5 + C5
P61	P6 + C1
P62	P6 + C2
P63	P6 + C3
P64	P6 + C4
P65	P6 + C5
P62R	P6 + radial internal clearance between upper part of C1 and lower part of C2
P63R	P6 + radial internal clearance between upper part of normal and lower part of C3
P64R	P6 + radial internal clearance between upper part of C3 and lower part of C4
P65R	P6 + radial internal clearance between upper part of C4 and lower part of C5
SP	Special precision class

Tab. 8 - Suffixes: dimensional and running accuracy, clearance

Suffixes	Other
VL	Victory Line: combination of state-of-the-art bearing features to meet the ever-demanding requirements of modern machinery. It is a combination of factors connected to internal geometry, surface finish, cage design, steel cleanliness, advanced heat treatments, and optimization of rolling element/raceway contact. It is not necessarily stated in the bearing code

Tab. 9 - Suffixes: other

Bearing designation	Decoding
6315 MC4S2	<ul style="list-style-type: none"> • bearing type 6: deep groove ball bearing • dimension series 03: width series 0 and diameter series 3 • bore diameter code 15: bore diameter $15 \times 5 = 75$ mm • cage type code M: machined brass cage guided on rolling elements • precision class: P0 • radial internal clearance: C4 • special suffix S2: rings heat stabilized for operating temperatures up to 250 °C
N 1964 KMP62ZB	<ul style="list-style-type: none"> • bearing type N: single row cylindrical roller bearing • dimension series 19: width series 1 and diameter series 9 • bore diameter code 64: bore diameter $64 \times 5 = 320$ mm • ring design K: tapered bore, taper 1:12 • cage type code M: machined brass cage guided on rolling elements • precision class: P6 • radial internal clearance: C2 • special suffix ZB: optimized roller profile
24130 K30CAW33S1	<ul style="list-style-type: none"> • bearing type 2: double row spherical roller bearing • dimension series 41: width series 4 and diameter series 1 • bore diameter code 30: bore diameter $30 \times 5 = 150$ mm • ring design K30: tapered bore, taper 1:30 • cage type code CA: double pronged machined brass cage. Bearing with symmetrical roller and retaining ribs • special suffix W33: annular groove and lubrication holes in the outer ring • special suffix S1: rings heat stabilized for operating temperatures up to 200 °C
293/600 EM	<ul style="list-style-type: none"> • bearing type 2: spherical roller bearing (thrust) • dimension series 93: height series 9 and diameter series 3 • bore diameter 600 mm • bearing design E: optimized internal design with reinforced execution • cage type code M: machined brass cage guided on shaft washer with or without retaining sleeve

Tab. 10 - Bearing designation examples



Ball bearings	12
Deep groove ball bearings	12
Bearings with contact seals	12
Internal clearance	12
Misalignment	13
Minimum load	13
Axial load carrying capacity	13
Designs and variants	15
Type J	15
Type TN	15
Type M	15
Special designs and variants	15
Seal type ZZ	15
Seal type 2RS	15
Prefixes	16
Suffixes	16
Product tables	18
Product tables	48
Angular contact ball bearings	72
Single row angular contact ball bearings	72
Misalignment	72
Minimum load	72
Designs and variants	73
Type M	73
Type DB	73
Type DF	73
Prefixes	74
Suffixes	74
Product tables	76

Double row angular contact ball bearings	92
Misalignment.....	92
Minimum load.....	92
Designs and variants	93
Type DBA	93
Type DB ₁	93
Type DB ₂	93
Type DB ₃	93
Type DF	93
Seal type DB/ZZ.....	94
Type DB/2RS	94
Suffixes.....	95
Product tables.....	96
Product tables.....	104
Four-point contact ball bearings.....	108
Misalignment.....	108
Minimum load.....	108
Designs and variants	109
Type Q.....	109
Type QJ	109
Suffixes.....	110

RKB
BEARING INDUSTRIES
SWITZERLAND

Ball bearings

The ball bearings (BBs) manufactured by RKB come in many designs, dimensions and series. They are conceived to withstand combined loads and high speeds, covering most requirements in a number of standard and special industrial applications. All RKB BBs are made from high quality materials and special heat treatments for superior performance.

Available in single and double row configuration, in open or sealed version, they are low-maintenance, which makes them an irreplaceable cost-effective solution in many cases.

For large size BBs, RKB can also apply Bainite Hardening Treatment (HB) and High Temperature Dimensional Stabilization (S) on rings and balls. The bearing dimensional and running accuracy conforms to ISO/ABMA/GOST specifications.



Deep groove ball bearings

RKB offers a wide range of deep groove ball bearings (DGGBs) in single row design (open, sealed or shielded), with proven performance in many industrial fields. Having optimized internal geometry, they can operate at high speeds, sustaining radial and axial loads in both directions and generating low friction.

RKB DGGBs are engineered to successfully respond to the most demanding application requirements, in terms of high speeds, heavy loads and low noise. This is mainly due to the use of the best raw materials and manufacturing technology, that permit to deliver only premium deep groove ball bearings.

Bearings with contact seals

Seals are retained in their correct position by a recess in the outer ring. They are normally made by acrylonitrile-butadiene rubber (NBR) with a metallic reinforcement, so the continuous range working temperature is from -40 to 100 °C. A peak temperature of 120 °C can be supported for a short period of time. If the sealed bearings have to be used in harsh conditions, e.g. high temperature or high rotation speed, a grease leakage from the inner ring side could take place. In these cases a special seals design could be requested, so please consult the RKB application engineering service.

Internal clearance

Single row deep groove ball bearings are produced as standard with Normal radial clearance CN, but they can be manufactured featuring C2, C3, C4 and C5 radial clearance, in accordance with the ISO 5753:2009.

Bearings with special radial clearance in a different range than ISO 5753:2009 can be manufactured on request.

The radial clearance values are provided in the **Tab. 1 page 14** and they are valid only for bearing not yet mounted and loaded.

Misalignment

For single row deep groove ball bearing is not possible to determine a unique value of the shaft and housing misalignment.

Permissible misalignment depends on several factors such as:

- Radial internal clearance;
- Bearing size;
- Internal design;
- Forces and moments acting on it.

According to the above concept and depending on the influences of all these variables, the corresponding permissible misalignment vary between 2 and 10 minutes of arc, but it has to be considered that the induced additional stress inside the bearing influences negatively its service life.

For additional information, please consult the RKB application engineering service.

Minimum load

A minimum radial load is requested for single row deep groove ball bearing to allow an adequate operating condition, especially in presence of difficult working conditions like: high speed, high acceleration and sudden changes of rotating direction. According to these operating conditions, a skidding between balls and raceways can be generated by the inertial forces, influencing negatively the bearing life. Minimum radial load help to prevent such problem and can be theoretically estimated using the following formula:

$$\frac{F_{rm}}{C_r} > 0,015$$

where:

- F_{rm} minimum radial load, [kN];
- C_r basic dynamic load rating, [kN].

Usually, the minimum radial load is reached or surpassed by the weight of the components supported by the bearing together with the loads acting on it, otherwise supplementary radial load must be applied on the single row

deep groove ball bearing. In application where a starting up at a low temperature is planned or a lubricant with high viscosity is used, a larger minimum radial load is required.

It is possible to apply the axial preload for single row deep groove ball bearing by adjusting one ring against the other one or by using springs.

Axial load carrying capacity

If the single row deep groove ball bearings are subjected to the axial load, its value should not exceed:

- $0.25 C_0$ for small bearing (bore up to 12 mm) and light series bearing (diameter series 8, 9, 0 and 1);
- $0.5 C_0$ for the other series.

It has to be considered that an excessive axial load will influenced negatively the bearing life.

d [mm]		Radial internal clearance [µm]									
		C2		CN		C3		C4		C5	
over	incl.	min.	max.	min.	max.	min.	max.	min.	max.	min.	max.
2,5	6	0	7	2	13	8	23	–	–	–	–
6	10	0	7	2	13	8	23	14	29	20	37
10	18	0	9	3	18	11	25	18	33	25	45
18	24	0	10	5	20	13	28	20	36	28	48
24	30	1	11	5	20	13	28	23	41	30	53
30	40	1	11	6	20	15	33	28	46	40	64
40	50	1	11	6	23	18	36	30	51	45	73
50	65	1	15	8	28	23	43	38	61	55	90
65	80	1	15	10	30	25	51	46	71	65	105
80	100	1	18	12	36	30	58	53	84	75	120
100	120	2	20	15	41	36	66	61	97	90	140
120	140	2	23	18	48	41	81	71	114	105	160
140	160	2	23	18	53	46	91	81	130	120	180
160	180	2	25	20	61	53	102	91	147	135	200
180	200	2	30	25	71	63	117	107	163	150	230
200	225	2	35	25	85	75	140	125	195	175	265
225	250	2	40	30	95	85	160	145	225	205	300
250	280	2	45	35	105	90	170	155	245	225	340
280	315	2	55	40	115	100	190	175	270	245	370
315	355	3	60	45	125	110	210	195	300	275	410
355	400	3	70	55	145	130	240	225	340	315	460
400	450	3	80	60	170	150	270	250	380	350	520
450	500	3	90	70	190	170	300	280	420	390	570
500	560	10	100	80	210	190	330	310	470	440	630
560	630	10	110	90	230	210	360	340	520	490	700
630	710	20	130	110	260	240	400	380	570	540	780
710	800	20	140	120	290	270	450	430	630	600	860
800	900	20	160	140	320	300	500	480	700	670	960
900	1 000	20	170	150	350	330	550	530	770	740	1 040
1 000	1 120	20	180	160	380	360	600	580	850	820	1 150
1 120	1 250	20	190	170	410	390	650	630	920	890	1 260
1 250	1 400	30	200	190	440	420	700	680	1 000	–	–
1 400	1 600	30	210	210	470	450	750	730	1 060	–	–

Tab. 1 - Radial internal clearance of deep groove ball bearings

Designs and variants

Type J

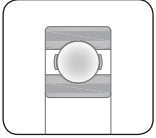

- One-piece inner and outer ring
- High strength two-piece pressed steel cage guided on balls (J)
- Execution suitable for high operating speeds
- Available with snap ring groove in outer ring for axial location (N)

Type TN

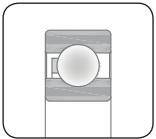

- One-piece inner and outer ring
- Moulded glass fiber reinforced polyamide snap-in cage guided on balls (TN)
- Execution suitable for very high accelerations and operating speeds

Type M

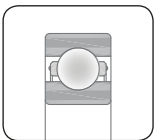

- One-piece inner and outer ring
- Two-piece machined brass cage guided on balls (M)
- Execution suitable for very high operating speeds
- Available with two-piece machined brass cage guided on inner ring (MB) or outer ring (MA)

- Available with axial lubrication grooves in the guiding surface of the cage (MAS/MBS)
- Available with locating slot for axial location (N)

Special designs and variants

Seal type ZZ

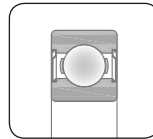

- One-piece inner and outer ring
- High strength two-piece pressed steel cage guided on balls (J)
- Two non-contacting steel shields at both sides (ZZ)
- Supplied already filled with grease for maintenance free operations
- Shielded type to keep the grease inside the bearing without compromising the limiting speed

Seal type 2RS

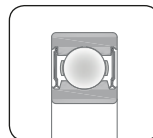

- One-piece inner and outer ring
- High strength two-piece pressed steel cage guided on balls (J)
- Two contacting rubber seals at both sides (2RS, or 2RSL for light contact)
- Supplied already filled with grease for maintenance free operations
- Sealed type to keep the grease inside the bearing and enhance contaminant exclusion

Prefixes

F	Flanged outer ring
DGBB	Out of standard deep groove ball bearing followed by drawing number

Suffixes Internal design

HSA	Special execution for high-speed wire guide blocks
-----	----------------------------------------------------

Suffixes Cage

J	Pressed steel cage
M	Machined brass cage guided on rolling elements
MA	Machined brass cage guided on outer ring
MAS	Machined brass cage guided on outer ring with lubrication grooves in the guiding surface
MB	Machined brass cage guided on inner ring
MBS	Machined brass cage guided on inner ring with lubrication grooves in the guiding surface
TN or ATN	Molded polyamide cage (PA66) guided on rolling elements
TN9	Molded glass fiber-reinforced polyamide cage (PA66-GF25) guided on rolling elements

Suffixes Accuracy, clearance, running

ABEC1	Approximated to tolerance class P0
ABEC3	Approximated to tolerance class P6
ABEC5	Approximated to tolerance class P5
ST	Special tolerance
CM	Special radial internal clearance for EMQ applications

Radial internal clearance of extra small and miniature ball bearings

Units: μm

Clearance symbol	MC1		MC2		MC3		MC4		MC5		MC6	
	min.	max.	min.	max.	min.	max.	min.	max.	min.	max.	min.	max.
MC1...MC6	0	5	3	8	5	10	8	13	13	20	20	28

- Remarks**
1. The standard clearance is MC3.
 2. To obtain the measured value, add the correction amount in the table below

CS	Special radial internal clearance
EMQ	Electric motor quality: bearing specifically designed for quiet running in electric motors
S12	Special selection for extremely low noise running
P66	Vibration peaks and noise level lower than normal

Suffixes	External design
Z	Shield on one side
ZZ or 2Z	Shield on both sides
RS	Contact seal on one side
2RS	Contact seal on both sides
RSL	Light contact seal on one side
2RSL	Light contact seal on both sides
G/R3	Filled with exceptionally good low noise and long life grease usable over a wide range of temperatures
G/R4	Filled with good low noise and high temperature, high speed and long life grease
N	Snap ring groove in outer ring
NR	Snap ring groove in outer ring with suitable snap ring
N1	One locating slot in outer ring
N2	Two locating slots in outer ring

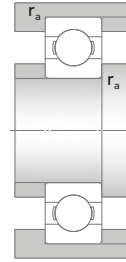
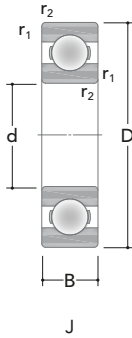

J

Main dimensions			Basic load ratings		Fatigue load limit C_u	Speed ratings		Designation
d	D	B	Dynamic C	Static C_0		Reference	Limiting	Standard design
[mm]			[kN]			[rpm]		
3	10	4	0,55	0,19	0,007	124000	70400	623
4	9	2,5	0,46	0,13	0,006	134000	73100	618/4
	11	4	0,71	0,20	0,009	127000	71200	619/4
	12	4	0,94	0,32	0,014	116000	65300	604
	13	5	1,04	0,31	0,013	107000	59000	624
	16	5	1,24	0,43	0,018	92600	54000	634
5	11	3	0,51	0,16	0,007	115000	66000	618/5
	13	4	1,00	0,37	0,015	107000	62300	619/5
	16	5	1,16	0,38	0,016	92400	51000	625
	19	6	2,32	0,95	0,040	77900	43100	635
6	13	3,5	0,77	0,25	0,011	106000	59000	618/6
	15	5	0,98	0,31	0,013	97600	56100	619/6
	19	6	2,29	0,94	0,040	77600	44500	626
7	14	3,5	0,88	0,30	0,013	96700	56700	618/7
	17	5	1,16	0,41	0,017	86900	47600	619/7
	19	6	2,29	0,95	0,040	82300	45100	607
	22	7	3,38	1,35	0,056	68000	39600	627
8	16	4	0,84	0,32	0,013	88100	49300	618/8
	19	6	1,51	0,50	0,022	82200	47700	619/8
	22	7	3,52	1,36	0,057	72800	41300	608
	24	8	3,98	1,65	0,071	61400	34800	628
9	17	4	0,89	0,36	0,015	82800	46100	618/9
	20	6	2,43	1,01	0,044	76900	44500	619/9
	24	7	3,94	1,65	0,071	67300	37800	609
	26	8	4,70	1,95	0,083	57900	32700	629
10	19	5	1,75	0,86	0,037	76800	41300	61800

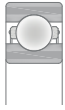

M

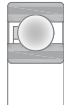

TN

Dimensions			Mass	Designation
d	r _{1,2min}	r _{amax}		Standard design
[mm]			[kg]	
3	0,15	0,1	0,002	623
4	0,1	0,1	0,001	618/4
	0,15	0,1	0,002	619/4
	0,2	0,2	0,002	604
	0,2	0,2	0,003	624
	0,3	0,3	0,005	634
5	0,15	0,1	0,001	618/5
	0,2	0,2	0,003	619/5
	0,3	0,3	0,005	625
	0,3	0,3	0,009	635
6	0,15	0,1	0,002	618/6
	0,2	0,2	0,004	619/6
	0,3	0,3	0,008	626
7	0,15	0,1	0,002	618/7
	0,3	0,3	0,005	619/7
	0,3	0,3	0,008	607
	0,3	0,3	0,012	627
8	0,2	0,2	0,003	618/8
	0,3	0,3	0,007	619/8
	0,3	0,3	0,012	608
	0,3	0,3	0,018	628
9	0,2	0,2	0,003	618/9
	0,3	0,3	0,008	619/9
	0,3	0,3	0,014	609
	0,3	0,3	0,02	629
10	0,3	0,3	0,005	61800

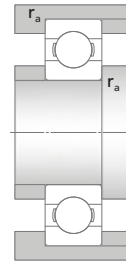
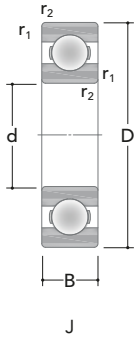

J

Main dimensions			Basic load ratings		Fatigue load limit C_u	Speed ratings		Designation
d	D	B	Dynamic C	Static C_0		Reference	Limiting	Standard design
[mm]			[kN]			[rpm]		
10 (cont.)	22	6	2,81	1,30	0,055	67400	39600	61900
	26	8	4,75	1,93	0,082	64500	34400	6000
	28	8	5,26	2,53	0,107	58200	34200	16100
	30	9	5,45	2,35	0,100	54700	32000	6200
	35	11	8,52	3,38	0,142	48200	28500	6300
12	21	5	1,83	0,96	0,041	68100	37400	61801
	24	6	3,07	1,56	0,066	65300	34400	61901
	28	8	5,45	2,36	0,100	58700	32700	6001
	30	8	5,07	2,46	0,104	58200	34200	16101
	32	10	7,21	3,04	0,129	48500	28200	6201
37	12	10,20	4,11	0,174	43600	24400	6301	
15	24	5	1,90	1,13	0,049	57900	32800	61802
	28	7	4,46	2,30	0,098	54000	29600	61902
	32	8	5,85	2,81	0,118	48800	27800	16002
	32	9	5,73	2,82	0,119	48400	28500	6002
	35	11	7,90	3,71	0,158	41600	23800	6202
	42	13	11,90	5,39	0,228	37100	21100	6302
17	26	5	2,04	1,35	0,057	54000	30600	61803
	30	7	4,81	2,68	0,114	48100	28500	61903
	35	8	6,50	3,24	0,137	44000	24400	16003
	35	10	6,24	3,23	0,136	43800	24400	6003
	40	12	9,95	4,73	0,199	37000	20600	6203
	47	14	14,2	6,49	0,272	32900	18700	6303
	62	17	24,0	11,1	0,468	27100	16000	6403
20	32	7	4,10	2,36	0,106	44000	25200	61804
	37	9	6,66	3,83	0,164	41600	22900	61904
	42	8	7,28	3,98	0,170	36900	21100	16004
	42	12	9,95	4,96	0,210	36900	21400	6004
	47	14	13,4	6,44	0,275	31100	18000	6204

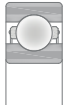

M

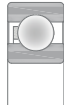

TN

Dimensions			Mass	Designation
d	r _{1,2min}	r _{amax}		Standard design
[mm]			[kg]	
10	0,3	0,3	0,01	61900
(cont.)	0,3	0,3	0,019	6000
	0,3	0,3	0,024	16100
	0,6	0,6	0,031	6200
	0,6	0,6	0,053	6300
	12	0,3	0,3	0,006
12	0,3	0,3	0,011	61901
	0,3	0,3	0,021	6001
	0,3	0,3	0,026	16101
	0,6	0,6	0,037	6201
	1	1	0,06	6301
	15	0,3	0,3	0,007
15	0,3	0,3	0,016	61902
	0,3	0,3	0,03	16002
	0,3	0,3	0,03	6002
	0,6	0,6	0,045	6202
	1	1	0,082	6302
	17	0,3	0,3	0,008
17	0,3	0,3	0,016	61903
	0,3	0,3	0,038	16003
	0,3	0,3	0,038	6003
	0,6	0,6	0,065	6203
	1	1	0,11	6303
	1,1	1	0,27	6403
	20	0,3	0,3	0,018
20	0,3	0,3	0,037	61904
	0,3	0,3	0,05	16004
	0,6	0,6	0,067	6004
	1	1	0,11	6204

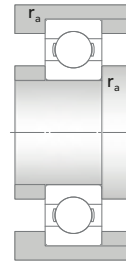
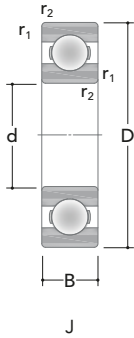

J

Main dimensions			Basic load ratings		Fatigue load limit C_u	Speed ratings		Designation
d	D	B	Dynamic C	Static C_0		Reference	Limiting	Standard design
[mm]			[kN]			[rpm]		
20	52	15	16,5	7,66	0,329	28800	16300	6304
(cont.)	72	19	31,9	16,0	0,683	23200	12800	6404
22	50	14	14,0	8,02	0,341	29000	16500	62/22
	56	16	19,2	9,62	0,403	27300	15700	63/22
25	37	7	4,48	2,79	0,134	36800	21400	61805
	42	9	7,31	4,62	0,207	34700	19800	61905
	47	8	7,90	4,70	0,210	31300	17600	16005
	47	12	11,7	6,44	0,270	30800	18000	6005
	52	15	14,8	7,70	0,331	27000	15800	6205
	62	17	23,6	11,4	0,482	23100	13600	6305
28	80	21	35,8	19,9	0,840	19200	11300	6405
	58	16	17,3	10,2	0,435	25000	14400	62/28
30	68	18	25,8	14,0	0,598	21500	12000	63/28
	42	7	4,61	2,98	0,150	31200	17600	61806
35	47	9	7,62	4,72	0,220	29300	16200	61906
	55	9	12,0	7,22	0,305	27200	14800	16006
	55	13	13,9	8,27	0,354	27000	15100	6006
	62	16	20,3	11,0	0,467	23000	12900	6206
	72	19	29,9	15,8	0,662	19200	11100	6306
	90	23	44,5	24,3	1,03	17400	9500	6406
	47	7	4,59	3,43	0,143	29200	15700	61807
35	55	10	11,3	8,30	0,346	25100	14200	61907
	62	9	13,3	8,02	0,369	23300	13500	16007
	62	14	16,6	10,2	0,440	23200	13100	6007
	72	17	27,5	15,1	0,646	19300	11700	6207
	80	21	35,8	19,4	0,831	18200	10200	6307
	100	25	54,9	32,6	1,36	15400	8900	6407

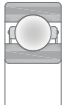

M

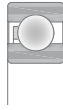

TN

Dimensions			Mass	Designation
d	r _{1,2min}	r _{amax}		Standard design
[mm]			[kg]	
20	1,1	1	0,14	6304
(cont.)	1,1	1	0,41	6404
22	1	1	0,13	62/22
	1,1	1	0,18	63/22
25	0,3	0,3	0,022	61805
	0,3	0,3	0,045	61905
	0,3	0,3	0,06	16005
	0,6	0,6	0,078	6005
	1	1	0,13	6205
	1,1	1	0,23	6305
	1,5	1,5	0,54	6405
28	1	1	0,17	62/28
	1,1	1	0,3	63/28
30	0,3	0,3	0,025	61806
	0,3	0,3	0,049	61906
	0,3	0,3	0,089	16006
	1	1	0,12	6006
	1	1	0,2	6206
	1,1	1	0,35	6306
	1,5	1,5	0,75	6406
35	0,3	0,3	0,029	61807
	0,6	0,6	0,08	61907
	0,3	0,3	0,11	16007
	1	1	0,15	6007
	1,1	1	0,29	6207
	1,5	1,5	0,46	6307
	1,5	1,5	0,97	6407

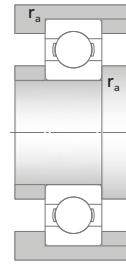
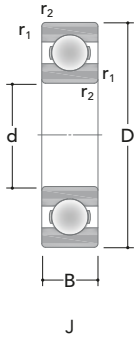

Main dimensions			Basic load ratings		Fatigue load limit C_u	Speed ratings		Designation Standard design
d	D	B	Dynamic C	Static C_0		Reference	Limiting	
[mm]			[kN]			[rpm]		
40	52	7	4,65	3,96	0,169	25400	14200	61808
	62	12	14,0	10,3	0,438	23400	12300	61908
	68	9	13,9	10,1	0,436	21500	12600	16008
	68	15	17,4	10,8	0,481	21400	12600	6008
	80	18	33,2	18,9	0,796	17300	9800	6208
	90	23	41,5	23,8	1,01	16500	9700	6308
	110	27	65,8	37,8	1,58	13600	8000	6408
45	58	7	6,92	6,26	0,267	21200	12000	61809
	68	12	14,1	11,0	0,474	19400	11600	61909
	75	10	16,8	10,6	0,510	19400	10200	16009
	75	16	21,7	14,5	0,636	19400	10700	6009
	85	19	35,1	21,3	0,902	16500	9700	6209
	100	25	55,9	31,3	1,33	14600	8200	6309
	120	29	78,6	48,0	2,03	12500	7400	6409
50	65	7	7,07	7,00	0,293	19300	11300	61810
	72	12	14,8	12,2	0,517	18200	10400	61910
	80	10	17,1	11,3	0,555	17400	9800	16010
	80	16	22,9	15,8	0,701	17600	9600	6010
	90	20	36,4	23,0	0,970	14500	8800	6210
	110	27	65,0	37,8	1,59	12600	10850	6310
	130	31	90,9	53,9	2,28	11600	6500	6410
55	72	9	9,48	9,32	0,397	18600	10600	61811
	80	13	16,6	15,1	0,647	16600	9700	61911
	90	11	20,1	13,9	0,690	15500	8600	16011
	90	18	29,3	20,9	0,887	15400	8900	6011
	100	21	46,7	28,5	1,23	13600	8100	6211
	120	29	74,1	44,6	1,88	11500	7000	6311
	140	33	102	64,7	2,71	10600	6200	6411
60	78	10	12,3	11,6	0,499	16300	9800	61812

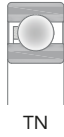
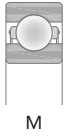

Dimensions			Mass	Designation
d	r _{1,2min}	r _{amax}		Standard design
[mm]			[kg]	
40	0,3	0,3	0,032	61808
	0,6	0,6	0,12	61908
	0,3	0,3	0,13	16008
	1	1	0,19	6008
	1,1	1	0,37	6208
	1,5	1,5	0,63	6308
	2	2	1,25	6408
45	0,3	0,3	0,04	61809
	0,6	0,6	0,14	61909
	0,6	0,6	0,17	16009
	1	1	0,24	6009
	1,1	1	0,42	6209
	1,5	1,5	0,84	6309
	2	2	1,55	6409
50	0,3	0,3	0,052	61810
	0,6	0,6	0,14	61910
	0,6	0,6	0,18	16010
	1	1	0,26	6010
	1,1	1	0,45	6210
	2	2	1,1	6310
	2,1	2	1,95	6410
55	0,3	0,3	0,083	61811
	1	1	0,19	61911
	0,6	0,6	0,27	16011
	1,1	1	0,39	6011
	1,5	1,5	0,61	6211
	2	2	1,35	6311
	2,1	2	2,35	6411
60	0,3	0,3	0,11	61812

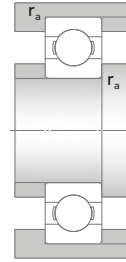
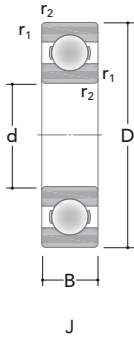

Main dimensions			Basic load ratings		Fatigue load limit C_u	Speed ratings		Designation Standard design
d	D	B	Dynamic C	Static C_0		Reference	Limiting	
[mm]			[kN]			[rpm]		
60 (cont.)	85	13	16,6	15,2	0,638	15600	8700	61912
	95	11	20,4	15,0	0,735	14600	8400	16012
	95	18	30,1	23,0	0,972	14500	8300	6012
	110	22	54,2	35,7	1,52	12600	11810	6212
	130	31	84,3	51,6	2,18	10600	9200	6312
	150	35	113	72,2	3,01	9700	5500	6412
65	85	10	12,8	13,3	0,566	15400	8900	61813
	90	13	17,5	16,4	0,697	14400	8500	61913
	100	11	22,3	19,4	0,822	13700	7900	16013
	100	18	32,2	24,7	1,05	13600	7800	6013
	120	23	57,9	40,0	1,71	11700	6700	6213
	140	33	98,5	59,0	2,46	9700	8100	6313
	160	37	120	83,5	3,37	9200	5400	6413
70	90	10	12,8	13,7	0,581	14400	7800	61814
	100	16	24,9	21,8	0,925	13700	7300	61914
	110	13	29,1	24,6	1,04	12600	7100	16014
	110	20	40,1	30,8	1,31	12600	7000	6014
	125	24	63,1	44,2	1,87	10600	6200	6214
	150	35	112	66,7	2,70	9200	7950	6314
	180	42	151	109	4,09	8300	4500	6414
	75	95	10	13,1	15,1	0,644	13400	7300
105		16	24,4	23,1	0,995	12600	6900	61915
115		13	30,5	27,0	1,14	11600	6500	16015
115		20	41,2	33,3	1,42	11500	6600	6015
130		25	68,2	48,3	2,01	9700	5900	6215
160		37	121	75,1	2,95	8700	7230	6315
190		45	159	117	4,26	7700	4500	6415
80		100	10	13,4	15,8	0,674	12500	7000
	110	16	26,5	21,7	1,09	11600	6500	61916

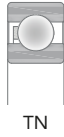
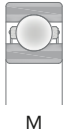

Dimensions			Mass	Designation
d	r _{1,2min}	r _{amax}		Standard design
[mm]			[kg]	
60	1	1	0,2	61912
(cont.)	0,6	0,6	0,29	16012
	1,1	1	0,41	6012
	1,5	1,5	0,78	6212
	2,1	2	1,7	6312
	2,1	2	2,85	6412
65	0,6	0,6	0,13	61813
	1	1	0,22	61913
	0,6	0,6	0,3	16013
	1,1	1	0,44	6013
	1,5	1,5	1	6213
	2,1	2	2,1	6313
2,1	2	3,35	6413	
70	0,6	0,6	0,14	61814
	1	1	0,35	61914
	0,6	0,6	0,44	16014
	1,1	1	0,61	6014
	1,5	1,5	1,1	6214
	2,1	2	2,55	6314
	3	2,5	4,95	6414
75	0,6	0,6	0,15	61815
	1	1	0,37	61915
	0,6	0,6	0,46	16015
	1,1	1	0,65	6015
	1,5	1,5	1,2	6215
	2,1	2	3,05	6315
	3	2,5	5,8	6415
80	0,6	0,6	0,15	61816
	1	1	0,38	61916

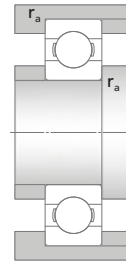
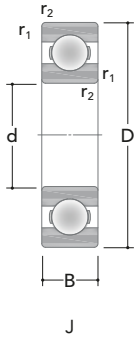

Main dimensions			Basic load ratings		Fatigue load limit C_u	Speed ratings		Designation Standard design
d	D	B	Dynamic C	Static C_0		Reference	Limiting	
[mm]			[kN]			[rpm]		
80	125	14	35,8	31,3	1,31	10700	6000	16016
(cont.)	125	22	48,9	39,9	1,66	10700	6200	6016
	140	26	72,8	54,8	2,19	9200	5300	6216
	170	39	129	85,0	3,19	8100	4800	6316
	200	48	171	133	4,79	7200	4200	6416
85	110	13	19,8	21,0	0,888	11600	6600	61817
	120	18	32,1	30,9	1,29	10700	6200	61917
	130	14	36,2	33,0	1,35	10700	5900	16017
	130	22	52,5	42,5	1,74	10700	6000	6017
	150	28	87,1	63,8	2,49	8700	4900	6217
	180	41	139	95,1	3,50	7700	4500	6317
	210	52	173	143	4,96	6700	3800	6417
90	115	13	19,7	23,1	0,961	10600	6000	61818
	125	18	34,2	33,8	1,38	10600	5800	61918
	140	16	42,7	38,5	1,54	9700	5400	16018
	140	24	59,9	49,8	1,95	9700	5500	6018
	160	30	102	72,8	2,77	8100	6780	6218
	190	43	154	107	3,76	7200	4300	6318
	225	54	190	153	5,10	6400	3800	6418
95	120	13	20,3	24,2	0,99	10600	5800	61819
	130	18	34,9	34,3	1,37	9700	5700	61919
	145	16	44,9	41,1	1,61	9100	5300	16019
	145	24	64,3	53,8	2,07	9200	5200	6019
	170	32	116	80,7	2,97	7600	6710	6219
	200	45	156	117	4,11	6700	4100	6319
100	125	13	17,9	19,2	1,00	9700	5500	61820
	140	20	42,6	44,0	1,73	9100	5300	61920
	150	16	45,7	43,4	1,68	9200	4800	16020
	150	24	65,0	53,0	2,00	9100	4900	6020

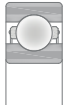

M

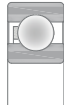

TN

Dimensions			Mass	Designation
d	r _{1,2min}	r _{amax}		Standard design
[mm]			[kg]	
80	0,6	0,6	0,61	16016
(cont.)	1,1	1	0,87	6016
	2	2	1,45	6216
	2,1	2	3,65	6316
	3	2,5	6,85	6416
85	1	1	0,27	61817
	1,1	1	0,55	61917
	0,6	0,6	0,64	16017
	1,1	1	0,92	6017
	2	2	1,8	6217
	3	2,5	4,25	6317
	4	3	8,05	6417
90	1	1	0,28	61818
	1,1	1	0,59	61918
	1	1	0,85	16018
	1,5	1,5	1,15	6018
	2	2	2,2	6218
	3	2,5	4,95	6318
	4	3	9,8	6418
95	1	1	0,3	61819
	1,1	1	0,61	61919
	1	1	0,89	16019
	1,5	1,5	1,1	6019
	2,1	2	2,65	6219
	3	2,5	5,75	6319
100	1	1	0,31	61820
	1,1	1	0,83	61920
	1	1	0,94	16020
	1,5	1,5	1,25	6020

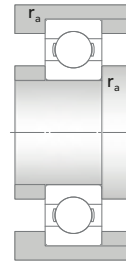
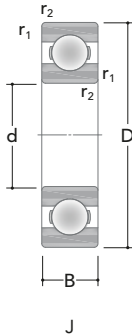

J

Main dimensions			Basic load ratings		Fatigue load limit C_u	Speed ratings		Designation
d	D	B	Dynamic C	Static C_0		Reference	Limiting	Standard design
[mm]			[kN]			[rpm]		
100	180	34	128	92,7	3,34	7200	4100	6220
(cont.)	215	47	180	145	4,92	6500	3900	6320
105	130	13	21,9	20,3	1,04	9700	5700	61821
	145	20	45,6	45,0	1,74	9200	5000	61921
	160	18	52,9	50,6	1,85	8100	4700	16021
	160	26	76,9	64,6	2,37	8200	4500	6021
	190	36	141	103	3,61	6700	4100	6221
	225	49	185	162	5,40	6100	3600	6321
110	140	16	29,2	27,0	1,30	9200	4800	61822
	150	20	44,6	46,5	1,72	8700	5000	61922
	170	19	60,5	56,4	2,02	7800	4300	16022
	170	28	86,9	72,4	2,56	7800	4300	6022
	200	38	153	117	3,97	6400	3700	6222
	240	50	209	189	5,99	5700	3300	6322
120	150	16	29,3	28,8	1,33	8200	4700	61824
	165	22	54,9	58,9	2,11	7700	4500	61924
	180	19	65,0	63,2	2,17	7200	4200	16024
	180	28	87,6	79,1	2,72	7300	4300	6024
	215	40	152	122	4,03	6100	3400	6224
	260	55	215	200	6,13	5400	2900	6324
130	165	18	38,5	46,1	1,72	7700	4100	61826
	180	24	67,8	71,3	2,43	7300	4000	61926
	200	22	84,9	81,4	2,70	6700	3700	16026
	200	33	110	100	3,35	6800	3800	6026
	230	40	159	137	4,31	5300	3200	6226
	280	58	235	223	6,50	4800	2800	6326
140	175	18	40,8	49,2	1,76	7300	4100	61828
	190	24	67,5	74,2	2,43	6700	4600	61928

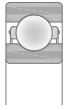

M

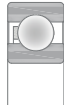

TN

Dimensions			Mass	Designation
d	r _{1,2min}	r _{amax}		Standard design
[mm]			[kg]	
100	2,1	2	3,15	6220
(cont.)	3	2,5	7,1	6320
105	1	1	0,32	61821
	1,1	1	0,87	61921
	1	1	1,2	16021
	2	2	1,6	6021
	2,1	2	3,8	6221
	3	2,5	8,15	6321
110	1	1	0,49	61822
	1,1	1	0,9	61922
	1	1	1,45	16022
	2	2	1,95	6022
	2,1	2	4,45	6222
	3	2,5	9,65	6322
120	1	1	0,54	61824
	1,1	1	1,2	61924
	1	1	1,55	16024
	2	2	2,1	6024
	2,1	2	5,25	6224
	3	2,5	12,5	6324
130	1,1	1	0,77	61826
	1,5	1,5	1,6	61926
	1,1	1	2,35	16026
	2	2	3,25	6026
	3	2,5	5,85	6226
	4	3	17,5	6326
140	1,1	1	0,85	61828
	1,5	1,5	2	61928

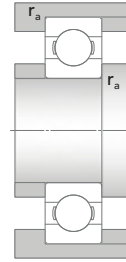
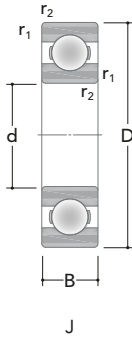

Main dimensions			Basic load ratings		Fatigue load limit C_u	Speed ratings		Designation
d	D	B	Dynamic C	Static C_0		Reference	Limiting	Standard design
[mm]			[kN]			[rpm]		
140	210	22	85,2	89,8	2,91	6500	3500	16028
(cont.)	210	33	114	110	3,51	6400	3500	6028
	250	42	167	152	4,61	5100	3100	6228
	300	62	259	258	7,48	4600	3600	6328
150	190	20	50,8	63,0	2,02	6500	3800	61830
	210	28	91,2	97,8	3,05	6100	4800	61930
	225	24	95,3	101	3,16	5800	3300	16030
	225	35	128	132	4,12	5800	3200	6030
	230	35	177	164	4,85	2600	2500	306891
	270	45	171	163	7,64	4800	2800	6230
	320	65	284	294	8,05	4100	3300	6330
160	200	20	51,3	68,4	2,14	6100	3400	61832
	220	28	95,3	102	3,19	5700	4100	61932
	240	25	104	110	3,31	5400	3200	16032
	240	38	150	149	4,48	5400	3100	6032
	290	48	192	190	5,41	4300	2600	6232
	340	68	292	293	7,86	3900	3100	6332
170	215	22	61,3	82,8	2,55	5700	3100	61834
	230	28	95,3	112	3,33	5300	4200	61934
	260	28	119	131	3,81	5100	2800	16034
	260	42	170	179	5,17	5100	3600	6034
	310	52	220	236	6,43	4100	3100	6234
	360	72	315	354	9,16	3600	2700	6334
180	225	22	65,8	83,6	2,51	5400	3100	61836
	250	33	120	139	4,18	5100	3700	61936
	259,5	33	145	153	4,45	2400	2100	306840
	280	31	141	151	4,29	4600	3500	16036
	280	46	189	215	6,02	4600	3400	6036
	320	52	241	244	6,51	3900	3100	6236

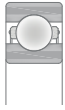

M

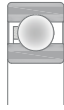

TN

Dimensions			Mass	Designation
d	r _{1,2min}	r _{amax}		Standard design
[mm]			[kg]	
140	1,1	1	2,55	16028
(cont.)	2	2	3,45	6028
	3	2,5	7,75	6228
	4	3	21,5	6328
150	1,1	1	1,2	61830
	2	2	3,05	61930
	1,1	1	3,15	16030
	2,1	2	4,3	6030
	2,1	2	5,3	306891
	3	2,5	10	6230
	4	3	26	6330
160	1,1	1	1,25	61832
	2	2	3,2	61932
	1,5	1,5	3,65	16032
	2,1	2	5,2	6032
	3	2,5	13	6232
	4	3	30,5	6332
170	1,1	1	1,65	61834
	2	2	3,4	61934
	1,5	1,5	5	16034
	2,1	2	8,15	6034
	4	3	18	6234
	4	3	36	6334
180	1,1	1	1,75	61836
	2	2	5	61936
	2,7	2,5	5,95	306840
	2	2	6,5	16036
	2,1	2	10,5	6036
	4	3	18,5	6236

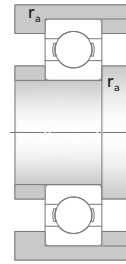
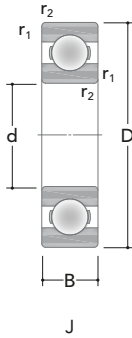

J

Main dimensions			Basic load ratings		Fatigue load limit C_u	Speed ratings		Designation
d	D	B	Dynamic C	Static C_0		Reference	Limiting	Standard design
[mm]			[kN]			[rpm]		
180	380	75	356	419	10,76	3400	2700	6336
(cont.)								
190	240	24	80,6	103	2,94	5100	2700	61838
	260	33	121	142	4,03	4800	3500	61938
	269,5	33	119	141	4,00	2300	2100	306627
	290	31	156	175	4,80	4600	2700	16038
	290	46	204	222	6,01	4600	3200	6038
	340	55	262	293	7,69	3600	2800	6238
	400	78	378	452	11,35	3200	2500	6338
190,5	290	46	197	222	6,01	2200	1900	408997
200	250	24	79,5	109	3,10	4800	2800	61840
	250	24	149	169	4,64	2000	1800	306870
	279,5	38	152	172	4,71	2100	1900	360278
	280	38	149	177	4,85	4600	3200	61940
	289,5	38	162	190	5,07	2000	1800	306841
	310	34	169	202	5,42	4100	2400	16040
	310	51	217	261	6,82	4100	3100	6040
	360	58	271	321	8,08	3400	2600	6240
	420	80	385	485	11,68	3000	2300	6340
220	270	24	82,0	118	3,22	4300	2500	61844
	300	38	156	192	5,07	4100	3000	61944
	300	25	83,0	126	3,31	2000	1800	60944
	309,5	38	159	190	5,01	1900	1800	306867
	340	37	178	211	5,38	3900	2000	16044
	340	56	257	303	7,68	3800	2600	6044
	400	65	296	384	9,26	3000	2400	6244
	460	88	415	527	12,2	2700	2100	6344
230	329,5	40	193	243	6,08	1800	1700	306842

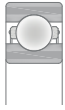

M

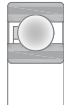

TN

Dimensions			Mass	Designation
d	r _{1,2min}	r _{amax}		Standard design
[mm]			[kg]	
180	4	3	42	6336
(cont.)				
190	1,5	1,5	2,25	61838
	2	2	5,2	61938
	2	2	6,25	306627
	2	2	6,9	16038
	2,1	2	11	6038
	4	3	22	6238
	5	4	48,5	6338
190,5	2	2	11	408997
200	1,5	1,5	2,35	61840
	1,9	1,5	2,65	306870
	2,1	2	7,25	360278
	2,1	2	7,3	61940
	2,1	2	8,7	306841
	2	2	8,8	16040
	2,1	2	14,5	6040
	4	3	26,5	6240
	5	4	55,5	6340
220	1,5	1,5	2,55	61844
	2,1	2	7,95	61944
	1,5	1,5	5	60944
	2,1	2	9,25	306867
	2,1	2	11,5	16044
	3	2,5	19	6044
	4	3	37	6244
	5	4	72,5	6344
230	2,1	2	12	306842

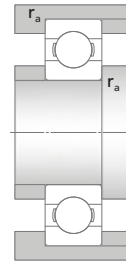
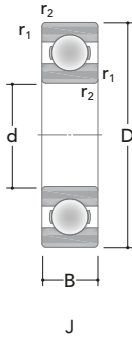

Main dimensions			Basic load ratings		Fatigue load limit C_u	Speed ratings		Designation Standard design
d	D	B	Dynamic C	Static C_0		Reference	Limiting	
[mm]			[kN]			[rpm]		
240	300	28	110	160	4,05	3900	2300	61848
	320	38	158	206	5,25	3800	2700	61948
	360	37	206	264	6,52	3500	2500	16048
	360	56	257	324	8,02	3400	2400	6048
	440	72	372	500	11,6	2900	2100	6248
	500	95	445	601	13,3	2500	2100	6348
260	320	28	112	173	4,25	3600	2100	61852
	360	46	217	288	6,99	3400	2500	61952
	369,5	46	217	290	7,25	1530	1500	306862
	400	44	251	325	7,55	3100	2400	16052
	400	65	305	389	9,13	3100	2400	6052
	480	80	393	561	12,5	2200	2000	6252
	540	102	521	745	15,7	2300	1800	6352
280	350	33	143	208	4,94	3200	2000	61856
	380	46	214	302	7,10	3000	2300	61956
	389,5	46	218	296	6,22	2900	2000	306861
	420	44	253	358	8,01	2900	2100	16056
	420	65	309	430	9,87	2900	2100	6056
	500	80	439	635	13,7	2500	1900	6256
	580	108	592	880	17,9	2200	1700	6356
	300	380	38	176	258	5,90	3100	2200
420		56	275	386	8,54	2900	2000	61960
460		50	285	416	9,04	2700	1800	16060
460		74	364	514	11,2	2700	1800	6060
540		85	470	708	14,5	2300	1700	6260
320	400	38	173	272	6,08	2900	2000	61864
	440	37	218	325	7,02	2800	2100	60964
	440	56	277	430	9,30	2700	2000	61964
	480	50	291	416	8,88	2500	1800	16064

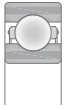

M

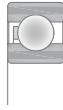

TN

Dimensions			Mass	Designation
d	r _{1,2min}	r _{amax}		Standard design
[mm]			[kg]	
240	2	2	3,9	61848
	2,1	2	8,55	61948
	2,1	2	14	16048
	3	2,5	20,5	6048
	4	3	51	6248
	5	4	92,5	6348
260	2	2	4,15	61852
	2,1	2	14,5	61952
	2,1	2	16,5	306862
	3	2,5	22,5	16052
	4	3	30	6052
	5	4	65,5	6252
280	6	5	115	6352
	2	2	6,25	61856
	2,1	2	15,5	61956
	2,1	2	18	306861
	3	2,5	24	16056
	4	3	31,5	6056
300	5	4	71	6256
	6	5	140	6356
	2,1	2	10,5	61860
	3	2,5	24,5	61960
	4	3	32	16060
	4	3	44	6060
320	5	4	88,5	6260
	2,1	2	11	61864
	2,1	2	16	60964
	3	2,5	25,5	61964
	4	3	34	16064

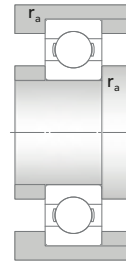
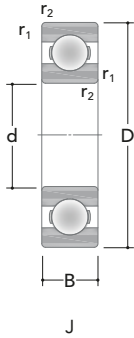

Main dimensions			Basic load ratings		Fatigue load limit C_u	Speed ratings		Designation
d	D	B	Dynamic C	Static C_0		Reference	Limiting	Standard design
[mm]			[kN]			[rpm]		
320	480	74	376	564	11,9	2500	1900	6064
(cont.)	580	92	535	829	16,6	2000	1700	6264
330	460	56	291	449	9,51	2500	1600	306728
340	420	38	183	286	6,24	2600	2000	61868
	460	56	281	439	9,30	2400	1800	61968
	480	60	305	451	9,44	1100	1000	306890
	520	57	353	549	11,2	2300	1700	16068
	520	82	437	649	13,4	2300	1700	6068
	620	92	585	961	18,5	1800	1300	6268
350	500	70	320	500	10,3	2400	1300	306674
360	440	38	182	294	6,29	2500	1900	61872
	440	25	126	226	4,80	2500	2000	60872
	480	56	308	476	9,68	2500	1800	61972
	540	57	368	593	11,9	2300	1500	16072
	540	82	445	735	14,8	2300	1600	6072
380	480	46	244	413	8,47	2300	1800	61876
	520	65	340	555	11,1	2300	1600	61976
	550	82	414	720	15,3	2600	2200	306682
	560	57	383	637	12,5	2100	1400	16076
	560	82	446	726	14,3	2100	1500	6076
400	500	46	249	413	8,31	2300	1700	61880
	500	31	170	297	5,94	2350	1800	60880
	540	65	360	601	11,8	2100	1500	61980
	540	44	263	471	9,1	2300	1700	60980
	590	74	450	762	14,4	2050	1600	306614
	600	90	542	911	17,2	1900	1500	6080

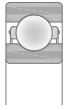

M

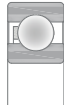

TN

Dimensions			Mass	Designation
d	r _{1,2min}	r _{amax}		Standard design
[mm]			[kg]	
320	4	3	46	6064
(cont.)	5	4	110	6264
330	3	2,5	30	306728
340	2,1	2	11,5	61868
	3	2,5	26,5	61968
	4	3	36	306890
	4	3	45	16068
	5	4	62	6068
	6	5	110	6268
350	4	3	46	306674
360	2,1	2	12	61872
	1,5	1,5	6,5	60872
	3	2,5	28	61972
	4	3	49	16072
	5	4	64,5	6072
380	2,1	2	20	61876
	4	3	40	61976
	5	4	65	306682
	4	3	51	16076
	5	4	70,5	6076
400	2,1	2	20,5	61880
	2	2	15,5	60880
	4	3	41,5	61980
	3	2,5	27,5	60980
	4	3	70	306614
	5	4	87,5	6080

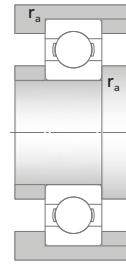
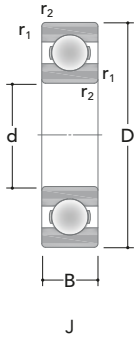

J

Main dimensions			Basic load ratings		Fatigue load limit C_u	Speed ratings		Designation
d	D	B	Dynamic C	Static C_0		Reference	Limiting	Standard design
[mm]			[kN]			[rpm]		
420	520	46	253	433	8,46	2100	1500	61884
	560	65	368	607	11,53	2100	1500	61984
	620	90	535	920	17,04	1900	1400	6084
440	540	46	260	453	8,75	2100	1600	61888
	540	31	158	304	5,87	2200	1700	60888
	600	74	413	747	13,7	1900	1400	61988
	600	50	328	590	10,9	1900	1600	60988
	650	94	585	1031	18,8	1800	1300	6088
460	580	56	337	597	11,1	1900	1400	61892
	620	74	432	759	13,9	1800	1400	61992
	680	100	595	1113	20,0	1700	1300	6092
480	600	56	336	616	11,1	1800	1400	61896
	650	78	470	864	15,5	1700	1300	61996
	700	100	624	1210	21,2	1600	1200	6096
487,5	650	78	445	855	15,0	980	1000	614885
500	620	56	331	661	11,9	1700	1300	618/500
	620	37	231	462	8,19	1600	1400	608/500
500	670	78	478	881	15,3	1600	1300	619/500
	720	100	633	1198	20,6	1500	1100	60/500
530	650	56	347	672	11,5	1600	1200	618/530
	710	82	500	963	16,2	1500	1100	619/530
	710	57	448	872	14,7	1500	1200	609/530
	760	100	601	1177	19,5	1400	1200	360476
	780	112	660	1313	21,5	1400	1100	60/530
560	680	56	344	722	12,3	1500	1100	618/560

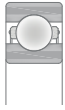

M

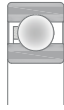

TN

Dimensions			Mass	Designation
d	r _{1,2min}	r _{amax}		Standard design
[mm]			[kg]	
420	2,1	2	21,5	61884
	4	3	43	61984
	5	4	91,5	6084
440	2,1	2	22,5	61888
	2	2	16,5	60888
	4	3	60,5	61988
	4	3	40	60988
	6	5	105	6088
460	3	2,5	35	61892
	4	3	62,5	61992
	6	5	120	6092
480	3	2,5	36,5	61896
	5	4	74	61996
	6	5	125	6096
487,5	5	4	65	614885
500	3	2,5	40,5	618/500
	2,1	2	20	608/500
500	5	4	77	619/500
	6	5	135	60/500
530	3	2,5	39,5	618/530
	5	4	90,5	619/530
	4	3	61	609/530
	6	5	150	360476
	6	5	185	60/530
560	3	2,5	42	618/560

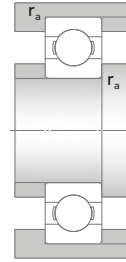
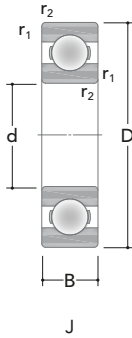

Main dimensions			Basic load ratings		Fatigue load limit C_u	Speed ratings		Designation
d	D	B	Dynamic C	Static C_0		Reference	Limiting	Standard design
[mm]			[kN]			[rpm]		
560 (cont.)	680	37	230	482	8,29	1400	1200	608/560
	750	85	508	1019	16,9	1400	1100	619/560
	820	115	666	1469	23,6	1300	1000	60/560
600	730	60	368	774	12,6	1400	1000	618/600
	730	42	276	563	9,21	1400	1000	608/600
	800	90	610	1246	20,0	1300	1000	619/600
	870	118	754	1569	24,7	1200	900	60/600
630	780	69	444	1026	16,3	1300	1000	618/630
	780	48	373	785	12,5	1300	1000	608/630
	850	100	640	1399	22,1	1200	1000	619/630
	850	71	500	1102	17,3	1200	1000	609/630
	920	128	822	1810	27,8	1100	900	60/630
650	920	118	794	1789	26,9	1050	900	306708
670	820	69	449	1029	16,1	1200	900	618/670
	900	103	688	1539	23,0	1100	900	619/670
	900	73	573	1307	19,9	1100	900	609/670
	980	136	912	2140	31,5	1010	800	60/670
710	870	74	475	1113	16,8	1100	900	618/710
	950	106	701	1594	23,4	1000	800	619/710
	950	78	570	1357	20,0	1000	800	609/710
	1000	140	856	1972	28,5	890	600	306704
	1030	140	990	2344	33,6	960	700	60/710
	1080	160	1040	2460	34,9	900	600	360141
730	940	100	671	1535	22,5	1050	800	361840
750	920	78	542	1257	18,4	1000	800	618/750
	1000	112	771	1844	26,1	960	800	619/750

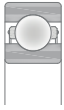

M



TN

Dimensions			Mass	Designation
d	r _{1,2min}	r _{amax}		Standard design
[mm]			[kg]	
560	2,1	2	30,5	608/560
(cont.)	5	4	105	619/560
	6	5	210	60/560
600	3	2,5	52	618/600
	3	2,5	40	608/600
	5	4	125	619/600
	6	5	230	60/600
630	4	3	73	618/630
	3	2,5	41	608/630
	6	5	160	619/630
	5	4	110	609/630
	7,5	6	285	60/630
650	6	5	250	306708
670	4	3	83,5	618/670
	6	5	185	619/670
	5	4	145	609/670
	7,5	6	345	60/670
710	4	3	93,5	618/710
	6	5	220	619/710
	5	4	150	609/710
	7,5	6	335	306704
	7,5	6	375	60/710
	7,5	6	505	360141
730	6	5	175	361840
750	5	4	110	618/750
	6	5	255	619/750

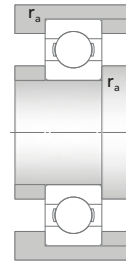
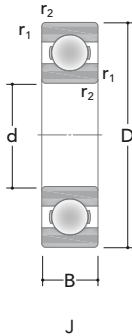

J

Main dimensions			Basic load ratings		Fatigue load limit C_u	Speed ratings		Designation
d	D	B	Dynamic C	Static C_0		Reference	Limiting	Standard design
[mm]			[kN]			[rpm]		
750	1090	150	1033	2516	35,7	950	700	60/750
(cont.)								
760	1080	150	967	2257	31,8	910	700	306474
800	980	82	560	1428	20,1	970	800	618/800
	980	57	418	1049	15,0	1100	700	608/800
	1060	115	851	2120	29,6	910	700	619/800
	1080	115	828	2121	29,6	980	700	361844
	1150	155	1030	2700	36,5	860	700	60/800
850	1030	82	580	1477	20,2	920	600	618/850
	1030	57	396	1081	14,8	940	700	608/850
	1120	118	838	2258	30,3	820	700	619/850
	1220	165	1080	2900	38,1	820	600	306493
	1220	165	1140	3010	39,4	810	600	60/850
900	1090	85	631	1627	22,0	830	600	618/900
	1180	122	868	2319	30,5	780	600	619/900
	1280	170	1130	3300	41,5	770	600	60/900
950	1150	90	6464	1802	23,3	780	600	618/950
	1250	132	1030	2990	38,4	760	600	619/950
	1360	180	1150	3450	43,0	720	500	60/950
1000	1220	100	668	1833	23,2	730	500	618/1000
	1220	71	549	1576	20,2	740	500	608/1000
	1320	103	832	2468	31,4	690	500	609/1000
	1320	140	1000	2950	37,4	690	500	619/1000
	1420	185	1350	4050	49,3	620	500	60/1000
1060	1280	100	725	2194	27,4	640	500	618/1060
	1400	150	1030	3080	37,0	610	500	619/1060
	1500	195	1561	4590	54,1	610	400	60/1060

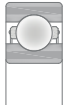

M

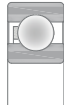

TN

Dimensions			Mass	Designation
d	r _{1,2min}	r _{amax}		Standard design
[mm]			[kg]	
750	7,5	6	485	60/750
(cont.)				
760	7,5	6	430	306474
800	5	4	130	618/800
	4	3	100	608/800
	6	5	275	619/800
	6	5	320	361844
	7,5	6	535	60/800
850	5	4	140	618/850
	4	3	75	608/850
	6	5	310	619/850
	7,5	6	630	306493
	7,5	6	630	60/850
900	5	4	160	618/900
	6	5	350	619/900
	7,5	6	720	60/900
950	5	4	190	618/950
	7,5	6	390	619/950
	7,5	6	860	60/950
1000	6	5	245	618/1000
	5	4	175	608/1000
	6	5	410	609/1000
	7,5	6	515	619/1000
	7,5	6	930	60/1000
1060	6	5	260	618/1060
	7,5	6	620	619/1060
	9,5	8	1080	60/1060

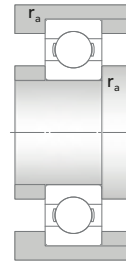
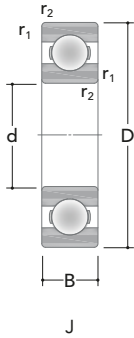

J

Main dimensions			Basic load ratings		Fatigue load limit C_u	Speed ratings		Designation
d	D	B	Dynamic C	Static C_0		Reference	Limiting	Standard design
[mm]			[kN]			[rpm]		
1120	1360	106	763	2354	28,4	600	500	618/1120
	1460	150	1040	3180	37,4	580	400	619/1120
	1580	200	1480	4740	53,9	530	400	60/1120
1180	1420	106	756	2459	28,7	540	400	618/1180
	1540	160	1130	3770	43,5	250	400	619/1180
1250	1500	112	856	2867	32,8	550	400	618/1250
1320	1600	122	968	3183	35,9	460	400	618/1320
	1720	128	1260	4190	45,5	420	300	609/1320
1400	1700	132	1160	4140	44,0	420	300	618/1400
	1820	185	1697	5830	60,4	400	300	619/1400
1500	1820	140	1240	4620	47,9	360	200	618/1500
	1950	195	1710	6280	63,8	320	300	619/1500
1600	1950	155	1290	4940	49,4	300	300	618/1600
	2060	200	1850	7360	73,6	300	300	619/1600
1700	2060	160	1250	5090	49,9	300	200	618/1700
	2180	212	2020	8200	79,1	290	200	619/1700

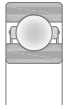

M

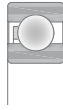

TN

Dimensions			Mass	Designation
d	r _{1,2min}	r _{amax}		Standard design
[mm]			[kg]	
1120	6	5	315	618/1120
	7,5	6	650	619/1120
	9,5	8	1250	60/1120
1180	6	5	330	618/1180
	7,5	6	775	619/1180
1250	6	5	385	618/1250
1320	6	5	500	618/1320
	7,5	6	830	609/1320
1400	7,5	6	615	618/1400
	9,5	8	1250	619/1400
1500	7,5	6	745	618/1500
	9,5	8	1500	619/1500
1600	7,5	6	965	618/1600
	9,5	8	1650	619/1600
1700	7,5	6	1100	618/1700
	9,5	8	1950	619/1700

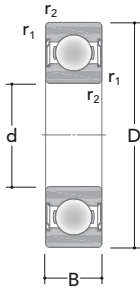

ZZ

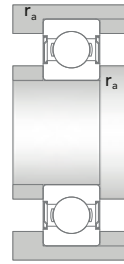

Main dimensions			Basic load ratings		Fatigue load limit C_u	Speed ratings		Designation Standard design	
d	D	B	Dynamic C	Static C_0		Reference	Limiting ⁽¹⁾		
[mm]			[kN]			[rpm]			
3	10	4	0,53	0,18	0,007	122200	55800	623	
		10	4	0,53	0,18	0,007	-	36800	623
4	9	3,5	0,55	0,18	0,07	127400	60300	628/4	
		9	4	0,53	0,18	0,07	126000	63700	638/4
		11	4	0,62	0,18	0,008	122200	58000	619/4
		12	4	0,81	0,28	0,012	112800	55200	604
		13	5	0,94	0,29	0,012	103400	47700	624
		16	5	1,12	0,39	0,016	88400	43200	634
		16	5	1,12	0,39	0,016	-	25200	634
5	11	4	0,64	0,26	0,011	108000	56400	628/5	
		11	5	0,63	0,26	0,011	109200	52100	638/5
		13	4	0,87	0,33	0,014	99000	51000	619/5
		16	5	1,13	0,37	0,016	85500	43700	625
		19	6	2,39	0,97	0,039	73600	37200	635
		19	6	2,39	0,97	0,039	-	20500	635
6	13	5	0,88	0,35	0,015	102300	45300	628/6	
		15	5	0,9	0,27	0,011	91000	46500	619/6
		19	6	2,36	0,94	0,04	75200	36000	626
		19	6	2,36	0,94	0,04	-	22100	626
7	14	5	0,96	0,4	0,017	94000	42900	628/7	
		17	5	1,07	0,37	0,016	81900	40500	619/7
		19	6	2,39	0,95	0,04	79100	40000	607
		19	6	2,39	0,95	0,04	-	22300	607
		22	7	3,42	1,35	0,056	65100	33100	627
		22	7	3,42	1,35	0,056	-	19000	627
8	16	5	1,36	0,57	0,024	83700	41400	628/8	
		16	5	1,36	0,57	0,024	-	23900	628/8
		16	6	1,33	0,57	0,024	82800	41900	638/8

⁽¹⁾ Bearings featuring ZZ or 2RS suffixes may reach lower speed values

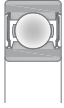

2RS

Dimensions			Mass	Designation	
d	r _{1,2min}	r _{amax}		Bearing sealed on	
[mm]			[kg]	both sides	one side
3	0,15	0,1	0,002	623 ZZ	623 Z
	0,15	0,1	0,002	623 2RS	623 RS
4	0,1	0,1	0,001	628/4 ZZ	-
	0,1	0,1	0,001	638/4 ZZ	-
	0,15	0,1	0,002	619/4 ZZ	-
	0,2	0,2	0,002	604 ZZ	604 Z
	0,2	0,2	0,003	624 ZZ	624 Z
	0,3	0,3	0,005	634 ZZ	634 Z
	0,3	0,3	0,005	634 2RS	634 RS
5	0,15	0,1	0,001	628/5 ZZ	-
	0,15	0,1	0,002	638/5 ZZ	-
	0,2	0,2	0,003	619/5 ZZ	-
	0,3	0,3	0,005	625 ZZ	625 Z
	0,3	0,3	0,009	635 ZZ	635 Z
	0,3	0,3	0,009	635 2RS	635 RS
6	0,15	0,1	0,003	628/6 ZZ	-
	0,2	0,2	0,004	619/6 ZZ	-
	0,3	0,3	0,008	626 ZZ	626 Z
	0,3	0,3	0,008	626 2RS	626 RS
7	0,15	0,1	0,003	628/7 ZZ	-
	0,3	0,3	0,005	619/7 ZZ	-
	0,3	0,3	0,008	607 ZZ	607 Z
	0,3	0,3	0,008	607 2RS	607 RS
	0,3	0,3	0,013	627 ZZ	627 Z
	0,3	0,3	0,013	627 2RS	627 RS
8	0,2	0,2	0,004	628/8 ZZ	-
	0,2	0,2	0,004	628/8 2RS	-
	0,2	0,2	0,004	638/8 ZZ	-

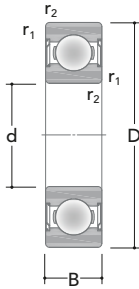

ZZ

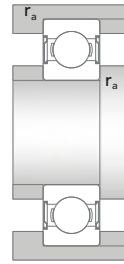

Main dimensions			Basic load ratings		Fatigue	Speed ratings		Designation
d	D	B	Dynamic C	Static C ₀	load limit C _u	Reference	Limiting ⁽¹⁾	Standard design
[mm]			[kN]			[rpm]		
8	19	6	1,47	0,46	0,02	78200	39600	619/8
(cont.)	19	6	1,47	0,46	0,02	-	22600	619/8
	19	6	2,29	0,94	0,04	79900	38700	607/8
	22	7	3,48	1,36	0,057	68300	34200	608
	22	7	3,48	1,36	0,057	-	20500	608
	22	11	3,45	1,36	0,057	-	20500	630/8
	24	8	3,86	1,65	0,071	56700	28800	628
	24	8	3,86	1,65	0,071	-	17300	628
	28	6	1,34	0,57	0,024	54600	27900	638
9	17	5	1,42	0,64	0,027	79100	37000	628/9
	17	5	1,42	0,64	0,027	-	21800	628/9
	20	6	2,39	0,96	0,042	72000	37600	619/9
	24	7	3,9	1,65	0,071	63700	30900	609
	24	7	3,9	1,65	0,071	-	16400	609
	26	8	4,85	1,95	0,083	55200	27900	629
	26	8	4,85	1,95	0,083	-	17900	629
10	19	5	1,75	0,83	0,035	73600	34600	61800
	19	5	1,75	0,83	0,035	-	20500	61800
	22	6	2,67	1,25	0,053	63700	32400	61900
	22	6	2,67	1,25	0,053	-	17300	61900
	26	8	4,8	1,93	0,082	63000	30900	6000
	26	8	4,8	1,93	0,082	-	17100	6000
	26	12	4,66	1,93	0,082	-	17100	63000
	28	8	5,12	2,34	0,099	54600	27000	16100
	30	9	5,51	2,35	0,102	51000	26300	6200
	30	9	5,51	2,35	0,099	-	16000	6200
	30	14	5,51	2,35	0,099	-	16000	62200
	35	11	8,43	3,38	0,143	45500	24400	6300
	35	11	8,43	3,38	0,143	-	14000	6300
	35	17	8,43	3,38	0,142	-	14000	62300

⁽¹⁾ Bearings featuring ZZ or 2RS suffixes may reach lower speed values

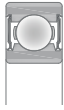

2RS

Dimensions			Mass	Designation	
d	r _{1,2min}	r _{amax}		Bearing sealed on	
[mm]			[kg]	both sides	one side
8 (cont.)	0,3	0,3	0,007	619/8 ZZ	-
	0,3	0,3	0,007	619/8 2RS	-
	0,3	0,3	0,007	607/8 ZZ	607/8 Z
	0,3	0,3	0,013	608 ZZ	608 Z
	0,3	0,3	0,013	608 2RS	608 RS
	0,3	0,3	0,016	630/8 2RS	-
	0,3	0,3	0,018	628 ZZ	628 Z
	0,3	0,3	0,018	628 2RS	628 RS
	0,3	0,3	0,03	638 ZZ	638 Z
9	0,2	0,2	0,004	628/9 ZZ	628/9 Z
	0,2	0,2	0,004	628/9 2RS	-
	0,3	0,3	0,008	619/9 ZZ	-
	0,3	0,3	0,015	609 ZZ	609 Z
	0,3	0,3	0,015	609 2RS	609 RS
	0,3	0,3	0,021	629 ZZ	629 Z
	0,3	0,3	0,021	629 2RS	629 RS
10	0,3	0,3	0,006	61800 ZZ	-
	0,3	0,3	0,006	61800 2RS	-
	0,3	0,3	0,01	61900 ZZ	-
	0,3	0,3	0,01	61900 2RS	-
	0,3	0,3	0,02	6000 ZZ	6000 Z
	0,3	0,3	0,02	6000 2RS	6000 RS
	0,3	0,3	0,025	63000 2RS	-
	0,3	0,3	0,026	16100 ZZ	-
	0,6	0,6	0,034	6200 ZZ	6200 Z
	0,6	0,6	0,034	6200 2RS	6200 RS
	0,6	0,6	0,04	62200 2RS	-
	0,6	0,6	0,055	6300 ZZ	6300 Z
	0,6	0,6	0,055	6300 2RS	6300 RS
	0,6	0,6	0,06	62300 2RS	-

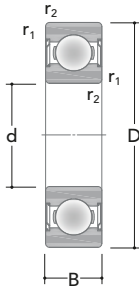

ZZ

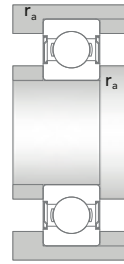

Main dimensions			Basic load ratings		Fatigue load limit C_u	Speed ratings		Designation
d	D	B	Dynamic C	Static C_0		Reference	Limiting ⁽¹⁾	Standard design
[mm]			[kN]			[rpm]		
12	21	5	1,74	0,9	0,04	64400	32400	61801
	21	5	1,74	0,9	0,04	-	18200	61801
	24	6	2,91	1,44	0,061	62300	28800	61901
	24	6	2,91	1,44	0,061	-	17300	61901
	28	8	5,45	2,36	0,099	56400	27000	6001
	28	8	5,45	2,36	0,099	-	15600	6001
	28	12	5,4	2,36	0,099	-	15600	63001
	30	8	5,17	2,34	0,1	55200	25900	16101
	30	8	5,17	2,34	0,1	-	13900	16101
	32	10	7,21	3,04	0,133	45500	24400	6201
	32	10	7,21	3,04	0,133	-	12800	6201
	32	14	7,13	3,04	0,131	-	12800	62201
	37	12	10,2	4,11	0,176	41900	20000	6301
	37	12	10,2	4,11	0,176	-	12900	6301
15	24	5	1,9	1,08	0,048	55200	27000	61802
	24	5	1,9	1,08	0,048	-	15600	61802
	28	7	4,36	2,21	0,096	51500	25200	61902
	28	7	4,36	2,21	0,096	-	14900	61902
	32	8	5,73	2,81	0,118	47000	23700	16002
	32	9	5,97	2,82	0,119	45000	24400	6002
	32	9	5,97	2,82	0,119	-	12700	6002
	32	13	5,97	2,82	0,119	-	12700	63002
	35	11	8,22	3,71	0,163	40400	20500	6202
	35	11	8,22	3,71	0,163	-	11200	6202
	35	14	8,22	3,71	0,157	-	11200	62202
	42	13	11,9	5,39	0,226	34200	17300	6302
	42	13	11,9	5,39	0,226	-	10300	6302
	42	17	11,9	5,39	0,223	-	10300	62302
17	26	5	2,07	1,25	0,055	52600	25500	61803
	26	5	2,07	1,25	0,055	-	14700	61803
	30	7	4,67	2,53	0,109	47000	23900	61903

⁽¹⁾ Bearings featuring ZZ or 2RS suffixes may reach lower speed values

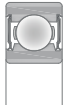

2RS

Dimensions			Mass	Designation	
d	r _{1,2min}	r _{amax}		Bearing sealed on	
[mm]			[kg]	both sides	one side
12	0,3	0,3	0,006	61801 ZZ	-
	0,3	0,3	0,006	61801 2RS	-
	0,3	0,3	0,011	61901 ZZ	-
	0,3	0,3	0,011	61901 2RS	-
	0,3	0,3	0,022	6001 ZZ	6001 Z
	0,3	0,3	0,022	6001 2RS	6001 RS
	0,3	0,3	0,029	63001 2RS	-
	0,3	0,3	0,028	16101 ZZ	-
	0,3	0,3	0,028	16101 2RS	-
	0,6	0,6	0,039	6201 ZZ	6201 Z
	0,6	0,6	0,039	6201 2RS	6201 RS
	0,6	0,6	0,045	62201 2RS	-
	1	1	0,063	6301 ZZ	6301 Z
	1	1	0,063	6301 2RS	6301 RS
15	0,3	0,3	0,007	61802 ZZ	-
	0,3	0,3	0,007	61802 2RS	-
	0,3	0,3	0,016	61902 ZZ	-
	0,3	0,3	0,016	61902 2RS	-
	0,3	0,3	0,025	16002 ZZ	16002 Z
	0,3	0,3	0,032	6002 ZZ	6002 Z
	0,3	0,3	0,032	6002 2RS	6002 RS
	0,3	0,3	0,039	63002 2RS	-
	0,6	0,6	0,048	6202 ZZ	6202 Z
	0,6	0,6	0,048	6202 2RS	6202 RS
	0,6	0,6	0,054	62202 2RS	-
	1	1	0,086	6302 ZZ	6302 Z
	1	1	0,086	6302 2RS	6302 RS
	1	1	0,11	62302 2RS	-
17	0,3	0,3	0,008	61803 ZZ	-
	0,3	0,3	0,008	61803 2RS	-
	0,3	0,3	0,017	61903 ZZ	-

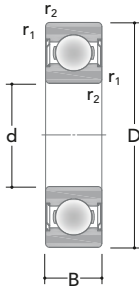

ZZ

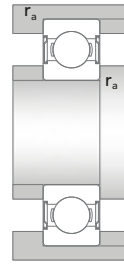

Main dimensions			Basic load ratings		Fatigue load limit C_u	Speed ratings		Designation
d	D	B	Dynamic C	Static C_0		Reference	Limiting ⁽¹⁾	Standard design
[mm]			[kN]			[rpm]		
17 (cont.)	30	7	4,67	2,53	0,109	-	12600	61903
	35	8	6,37	3,23	0,136	42300	20200	16003
	35	10	6,31	3,23	0,136	41400	20500	6003
	35	10	6,31	3,23	0,136	-	11800	6003
	35	14	6,24	3,23	0,134	-	11800	63003
	40	12	10,15	4,73	0,204	35700	17700	6203
	40	12	10,15	4,73	0,204	-	11300	6203
	40	16	10,15	4,73	0,204	-	11300	62203
	47	14	14,59	6,49	0,275	31300	15800	6303
	47	14	14,59	6,49	0,275	-	10200	6303
47	19	14,59	6,49	0,272	-	10200	62303	
20	32	7	3,99	2,29	0,103	41400	20000	61804
	32	7	3,99	2,29	0,103	-	11100	61804
	37	9	6,31	3,61	0,159	39600	18800	61904
	37	9	6,31	3,61	0,159	-	10800	61904
	42	12	10,15	4,96	0,212	35000	17300	6004
	42	12	10,15	4,96	0,212	-	9900	6004
	42	16	10,15	4,96	0,212	-	9900	63004
	47	14	13,77	6,44	0,28	29100	15300	6204
	47	14	13,77	6,44	0,28	-	9200	6204
	47	18	13,23	6,44	0,277	-	9200	62204
	52	15	16,63	7,66	0,332	27300	14000	6304
	52	15	16,63	7,66	0,332	-	8600	6304
52	21	16,63	7,66	0,332	-	8600	62304	
22	50	14	14,28	7,51	0,332	-	7700	62/22
25	37	7	4,45	2,58	0,128	35000	17900	61805
	37	7	4,45	2,58	0,128	-	10100	61805
	42	9	7,16	4,28	0,195	33100	16700	61905
	42	9	7,16	4,28	0,195	-	9400	61905
	47	12	12,14	6,44	0,278	29400	14600	6005

⁽¹⁾ Bearings featuring ZZ or 2RS suffixes may reach lower speed values

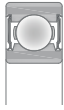

2RS

Dimensions			Mass	Designation	
d	r _{1,2min}	r _{amax}		Bearing sealed on	
[mm]			[kg]	both sides	one side
17	0,3	0,3	0,017	61903 2RS	-
(cont.)	0,3	0,3	0,032	16003 ZZ	-
	0,3	0,3	0,041	6003 ZZ	6003 Z
	0,3	0,3	0,041	6003 2RS	6003 RS
	0,3	0,3	0,052	63003 2RS	-
	0,6	0,6	0,068	6203 ZZ	6203 Z
	0,6	0,6	0,068	6203 2RS	6203 RS
	0,6	0,6	0,089	62203 2RS	-
	1	1	0,12	6303 ZZ	6303 Z
	1	1	0,12	6303 2RS	6303 RS
	1	1	0,16	62303 2RS	-
20	0,3	0,3	0,018	61804 ZZ	-
	0,3	0,3	0,018	61804 2RS	-
	0,3	0,3	0,038	61904 ZZ	-
	0,3	0,3	0,038	61904 2RS	-
	0,6	0,6	0,071	6004 ZZ	6004 Z
	0,6	0,6	0,071	6004 2RS	6004 RS
	0,6	0,6	0,086	63004 2RS	-
	1	1	0,11	6204 ZZ	6204 Z
	1	1	0,11	6204 2RS	6204 RS
	1	1	0,13	62204 2RS	-
	1,1	1	0,15	6304 ZZ	6304 Z
1,1	1	0,15	6304 2RS	6304 RS	
1,1	1	0,21	62304 2RS	-	
22	1	1	0,12	62/22 2RS	-
25	0,3	0,3	0,022	61805 ZZ	-
	0,3	0,3	0,022	61805 2RS	-
	0,3	0,3	0,045	61905 ZZ	-
	0,3	0,3	0,045	61905 2RS	-
	0,6	0,6	0,083	6005 ZZ	6005 Z

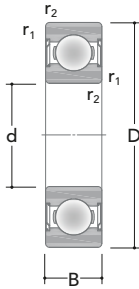

ZZ

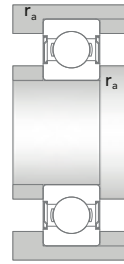

Main dimensions			Basic load ratings		Fatigue load limit C_u	Speed ratings		Designation
d	D	B	Dynamic C	Static C_0		Reference	Limiting ⁽¹⁾	Standard design
[mm]			[kN]			[rpm]		
25	47	12	12,14	6,44	0,278	-	8100	6005
(cont.)	47	16	12,14	6,44	0,278	-	8100	63005
	52	15	14,7	7,7	0,342	26300	12600	6205
	52	15	14,7	7,7	0,342	-	7700	6205
	52	18	14,5	7,7	0,342	-	7700	62205
	62	17	23,63	11,4	0,5	21800	12200	6305
	62	17	23,63	11,4	0,5	-	6900	6305
	62	24	23,63	11,4	0,49	-	6900	62305
30	42	7	4,4	2,89	0,145	28800	14900	61806
	42	7	4,4	2,89	0,145	-	8600	61806
	47	9	7,13	4,54	0,214	28200	14100	61906
	47	9	7,13	4,54	0,214	-	7700	61906
	55	13	13,94	8,27	0,362	25200	13000	6006
	55	13	13,94	8,27	0,362	-	7300	6006
	55	19	13,66	8,27	0,362	-	7300	63006
	62	16	20,1	11	0,485	22600	11200	6206
	62	16	20,5	11	0,485	-	6400	6206
	62	20	20,5	11	0,485	-	6400	62206
	72	19	29,9	15,8	0,663	18600	10300	6306
	72	19	29,9	15,8	0,663	-	5900	6306
	72	27	29,9	15,8	0,663	-	5900	62306
35	47	7	4,4	3,3	0,143	27600	13800	61807
	47	7	4,4	3,3	0,143	-	7800	61807
	55	10	10,8	7,79	0,328	24400	12000	61907
	55	10	10,8	7,79	0,328	-	6900	61907
	62	14	16,97	10,2	0,449	22100	11200	6007
	62	14	16,97	10,2	0,449	-	6400	6007
	62	20	16,63	10,2	0,449	-	6400	63007
	72	17	27,54	15,1	0,642	18600	9300	6207
	72	17	27,54	15,1	0,642	-	5700	6207
	72	23	27,54	15,1	0,642	-	5700	62207

⁽¹⁾ Bearings featuring ZZ or 2RS suffixes may reach lower speed values

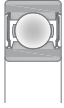

2RS

Dimensions			Mass	Designation	
d	r _{1,2min}	r _{amax}		Bearing sealed on	
[mm]			[kg]	both sides	one side
25	0,6	0,6	0,083	6005 2RS	6005 RS
(cont.)	0,6	0,6	0,11	63005 2RS	-
	1	1	0,13	6205 ZZ	6205 Z
	1	1	0,13	6205 2RS	6205 RS
	1	1	0,15	62205 2RS	-
	1,1	1	0,23	6305 ZZ	6305 Z
	1,1	1	0,23	6305 2RS	6305 RS
	1,1	1	0,32	62305 2RS	-
30	0,3	0,3	0,025	61806 ZZ	-
	0,3	0,3	0,025	61806 2RS	-
	0,3	0,3	0,05	61906 ZZ	-
	0,3	0,3	0,05	61906 2RS	-
	1	1	0,12	6006 ZZ	6006 Z
	1	1	0,12	6006 2RS	6006 RS
	1	1	0,17	63006 2RS	-
	1	1	0,2	6206 ZZ	6206 Z
	1	1	0,25	6206 2RS	6206 RS
	1	1	0,25	62206 2RS	-
	1,1	1	0,36	6306 ZZ	6306 Z
	1,1	1	0,36	6306 2RS	6306 RS
	1,1	1	0,5	62306 2RS	-
35	0,3	0,3	0,03	61807 ZZ	-
	0,3	0,3	0,03	61807 2RS	-
	0,6	0,6	0,08	61907 ZZ	-
	0,6	0,6	0,08	61907 2RS	-
	1	1	0,16	6007 ZZ	6007 Z
	1	1	0,16	6007 2RS	6007 RS
	1	1	0,23	63007 2RS	-
	1,1	1	0,3	6207 ZZ	6207 Z
	1,1	1	0,3	6207 2RS	6207 RS
	1,1	1	0,4	62207 2RS	-

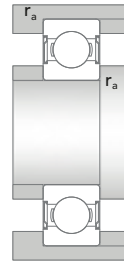
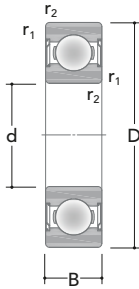

ZZ

Main dimensions			Basic load ratings		Fatigue load limit C_u	Speed ratings		Designation
d	D	B	Dynamic C	Static C_0		Reference	Limiting ⁽¹⁾	Standard design
[mm]			[kN]			[rpm]		
35	80	21	35,1	18,81	0,823	17500	8900	6307
(cont.)	80	21	34,4	18,81	0,823	-	5200	6307
	80	31	34,4	18,81	0,799	-	5200	62307
40	52	7	4,45	3,7	0,162	23700	11700	61808
	52	7	4,45	3,7	0,162	-	6900	61808
	62	12	13,8	9,86	0,429	22100	10800	61908
	62	12	13,8	9,86	0,429	-	6100	61908
	68	15	17,62	10,8	0,48	19800	10300	6008
	68	15	17,62	10,8	0,48	-	5900	6008
	68	21	17,44	10,8	0,48	-	5900	63008
	80	18	32,83	18,9	0,816	16900	8100	6208
	80	18	32,83	18,9	0,816	-	5200	6208
	80	23	32,83	18,9	0,792	-	5200	62208
	90	23	42,72	23,8	1,03	15600	8000	6308
	90	23	42,72	23,8	1,03	-	4500	6308
	90	33	41,88	23,8	1	-	4500	62308
45	58	7	6,7	6,02	0,257	20200	10100	61809
	58	7	6,7	6,02	0,257	-	5700	61809
	68	12	14,28	10,7	0,465	18600	9000	61909
	68	12	14,28	10,7	0,465	-	5500	61909
	75	16	21,88	14,5	0,653	18000	9000	6009
	75	16	21,88	14,5	0,653	-	4800	6009
	75	23	21,88	14,5	0,64	-	4800	63009
	85	19	35,8	21,3	0,933	15300	8000	6209
	85	19	35,8	21,3	0,933	-	4500	6209
	85	23	35,8	21,3	0,906	-	4500	62209
	100	25	56,41	31,3	1,367	14000	6800	6309
	100	25	56,41	31,3	1,367	-	4200	6309
	100	36	56,41	31,3	1,313	-	4200	62309
50	65	7	6,76	6,73	0,291	18800	9100	61810

⁽¹⁾ Bearings featuring ZZ or 2RS suffixes may reach lower speed values

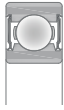

2RS

Dimensions			Mass	Designation	
d	r _{1,2min}	r _{amax}		Bearing sealed on	
[mm]			[kg]	both sides	one side
35	1,5	1,5	0,48	6307 ZZ	6307 Z
(cont.)	1,5	1,5	0,48	6307 2RS	6307 RS
	1,5	1,5	0,68	62307 2RS	-
40	0,3	0,3	0,034	61808 ZZ	-
	0,3	0,3	0,034	61808 2RS	-
	0,6	0,6	0,12	61908 ZZ	-
	0,6	0,6	0,12	61908 2RS	-
	1	1	0,2	6008 ZZ	6008 Z
	1	1	0,2	6008 2RS	6008 RS
	1	1	0,27	63008 2RS	-
	1,1	1	0,38	6208 ZZ	6208 Z
	1,1	1	0,38	6208 2RS	6208 RS
	1,1	1	0,47	62208 2RS	-
	1,5	1,5	0,65	6308 ZZ	6308 Z
	1,5	1,5	0,65	6308 2RS	6308 RS
	1,5	1,5	0,92	62308 2RS	-
45	0,3	0,3	0,04	61809 ZZ	-
	0,3	0,3	0,04	61809 2RS	-
	0,6	0,6	0,14	61909 ZZ	-
	0,6	0,6	0,14	61909 2RS	-
	1	1	0,25	6009 ZZ	6009 Z
	1	1	0,25	6009 2RS	6009 RS
	1	1	0,36	63009 2RS	-
	1,1	1	0,43	6209 ZZ	6209 Z
	1,1	1	0,43	6209 2RS	6209 RS
	1,1	1	0,51	62209 2RS	-
	1,5	1,5	0,87	6309 ZZ	6309 Z
	1,5	1,5	0,87	6309 2RS	6309 RS
	1,5	1,5	1,2	62309 2RS	-
50	0,3	0,3	0,052	61810 ZZ	-

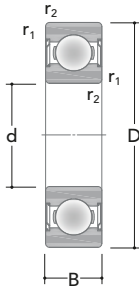

ZZ

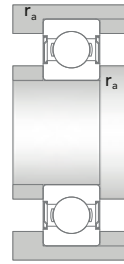

Main dimensions			Basic load ratings		Fatigue	Speed ratings		Designation
d	D	B	Dynamic C	Static C ₀	load limit C _u	Reference	Limiting ⁽¹⁾	Standard design
[mm]			[kN]			[rpm]		
50	65	7	6,76	6,73	0,291	-	5600	61810
(cont.)	72	12	14,75	11,7	0,5	17700	8600	61910
	72	12	14,75	11,7	0,5	-	5200	61910
	80	16	22,9	15,8	0,717	16600	8100	6010
	80	16	22,9	15,8	0,717	-	4700	6010
	80	23	22,44	15,8	0,696	-	4700	63010
	90	20	37,84	22,97	0,97	13800	7400	6210
	90	20	37,84	22,97	0,97	-	4100	6210
	90	23	37,84	22,97	0,97	-	4100	62210
	110	27	63,7	37,8	1,632	12200	6200	6310
	110	27	63,7	37,8	1,632	-	4000	6310
	110	40	63,7	37,8	1,632	-	4000	62310
55	72	9	8,86	8,71	0,379	17900	8600	61811
	72	9	8,86	8,71	0,379	-	4600	61811
	80	13	16,83	14	0,612	15500	8000	61911
	80	13	16,83	14	0,612	-	4600	61911
	90	18	30,19	20,9	0,918	14900	7200	6011
	90	18	30,19	20,9	0,918	-	4200	6011
	100	21	47,12	28,5	1,275	13200	6500	6211
	100	21	47,12	28,5	1,275	-	3900	6211
	100	25	46,66	28,5	1,25	-	3900	62211
	120	29	73,36	44,6	1,919	10900	5900	6311
	120	29	73,36	44,6	1,919	-	3600	6311
	120	43	72,62	44,6	1,9	-	3600	62311
60	78	10	12,02	11,3	0,49	15800	7900	61812
	78	10	12,02	11,3	0,49	-	4300	61812
	85	13	16,83	14,1	0,6	15000	7400	61912
	85	13	16,83	14,1	0,6	-	4200	61912
	95	18	31,01	23	0,98	13800	6800	6012
	95	18	31,01	23	0,98	-	3900	6012
	110	22	54,75	35,7	1,545	11800	5900	6212

⁽¹⁾ Bearings featuring ZZ or 2RS suffixes may reach lower speed values

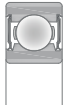

2RS

Dimensions			Mass	Designation	
d	r _{1,2min}	r _{amax}		Bearing sealed on	
[mm]			[kg]	both sides	one side
50 (cont.)	0,3	0,3	0,052	61810 2RS	-
	0,6	0,6	0,14	61910 ZZ	-
	0,6	0,6	0,14	61910 2RS	-
	1	1	0,27	6010 ZZ	6010 Z
	1	1	0,27	6010 2RS	6010 RS
	1	1	0,38	63010 2RS	-
	1,1	1	0,47	6210 ZZ	6210 Z
	1,1	1	0,47	6210 2RS	6210 RS
	1,1	1	0,54	62210 2RS	-
	2	2	1,1	6310 ZZ	6310 Z
	2	2	1,1	6310 2RS	6310 RS
	2	2	1,6	62310 2RS	-
	55	0,3	0,3	0,083	61811 ZZ
0,3		0,3	0,083	61811 2RS	-
1		1	0,19	61911 ZZ	-
1		1	0,19	61911 2RS	-
1,1		1	0,4	6011 ZZ	6011 Z
1,1		1	0,4	6011 2RS	6011 RS
1,5		1,5	0,64	6211 ZZ	6211 Z
1,5		1,5	0,64	6211 2RS	6211 RS
1,5		1,5	0,75	62211 2RS	-
2		2	1,4	6311 ZZ	6311 Z
2		2	1,4	6311 2RS	6311 RS
2		2	2,05	62311 2RS	-
60		0,3	0,3	0,11	61812 ZZ
	0,3	0,3	0,11	61812 2RS	-
	1	1	0,2	61912 ZZ	-
	1	1	0,2	61912 2RS	-
	1,1	1	0,43	6012 ZZ	6012 Z
	1,1	1	0,43	6012 2RS	6012 RS
	1,5	1,5	0,81	6212 ZZ	6212 Z

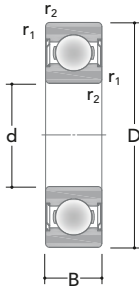

ZZ

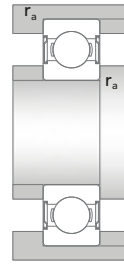

Main dimensions			Basic load ratings		Fatigue load limit C_u	Speed ratings		Designation
d	D	B	Dynamic C	Static C_0		Reference	Limiting ⁽¹⁾	Standard design
[mm]			[kN]			[rpm]		
60	110	22	54,75	35,7	1,545	-	3600	6212
(cont.)	110	28	54,19	35,7	1,545	-	3600	62212
	130	31	86,9	51,6	2,156	10200	5100	6312
	130	31	86,9	51,6	2,156	-	3200	6312
	130	46	86,05	51,6	2,156	-	3200	62312
65	85	10	12,4	12,5	0,54	14600	7300	61813
	85	10	12,4	12,5	0,54	-	4200	61813
	90	13	17,75	15,8	0,68	13700	7100	61913
	90	13	17,75	15,8	0,68	-	3700	61913
	100	18	31,9	24,7	1,071	12600	6400	6013
	100	18	31,9	24,7	1,071	-	3700	6013
	120	23	59,09	40	1,747	11200	5500	6213
	120	23	59,09	40	1,747	-	3300	6213
	120	31	58,5	40	1,747	-	3300	62213
	140	33	99,45	59	2,45	9300	4900	6313
	140	33	99,45	59	2,45	-	2900	6313
	140	48	95,55	59	2,45	-	2900	62313
70	90	10	12,4	13	0,571	14000	7000	61814
	90	10	12,4	13	0,571	-	3700	61814
	100	16	23,32	21	0,882	13200	6400	61914
	100	16	23,32	21	0,882	-	3700	61914
	110	20	40,1	30,8	1,346	11800	5800	6014
	110	20	40,1	30,8	1,346	-	3300	6014
	125	24	64,97	44,2	1,919	10000	5000	6214
	125	24	64,97	44,2	1,919	-	2900	6214
	125	31	64,97	44,2	1,919	-	2900	62214
	150	35	112,11	66,7	2,723	8600	4600	6314
	150	35	112,11	66,7	2,723	-	2800	6314
	150	51	112,11	66,7	2,695	-	2800	62314
75	95	10	12,95	14,1	0,61	12700	6500	61815

⁽¹⁾ Bearings featuring ZZ or 2RS suffixes may reach lower speed values

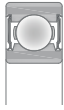

2RS

Dimensions			Mass	Designation	
d	r _{1,2min}	r _{amax}		Bearing sealed on	
[mm]			[kg]	both sides	one side
60	1,5	1,5	0,81	6212 2RS	6212 RS
(cont.)	1,5	1,5	1	62212 2RS	-
	2,1	2	1,8	6312 ZZ	6312 Z
	2,1	2	1,8	6312 2RS	6312 RS
	2,1	2	2,55	62312 2RS	-
65	0,6	0,6	0,13	61813 ZZ	-
	0,6	0,6	0,13	61813 2RS	-
	1	1	0,22	61913 ZZ	-
	1	1	0,22	61913 2RS	-
	1,1	1	0,46	6013 ZZ	6013 Z
	1,1	1	0,46	6013 2RS	6013 RS
	1,5	1,5	1,05	6213 ZZ	6213 Z
	1,5	1,5	1,05	6213 2RS	6213 RS
	1,5	1,5	1,4	62213 2RS	-
	2,1	2	2,15	6313 ZZ	6313 Z
	2,1	2	2,15	6313 2RS	6313 RS
	2,1	2	3	62313 2RS	-
70	0,6	0,6	0,14	61814 ZZ	-
	0,6	0,6	0,14	61814 2RS	-
	1	1	0,35	61914 ZZ	-
	1	1	0,35	61914 2RS	-
	1,1	1	0,64	6014 ZZ	6014 Z
	1,1	1	0,64	6014 2RS	6014 RS
	1,5	1,5	1,15	6214 ZZ	6214 Z
	1,5	1,5	1,15	6214 2RS	6214 RS
	1,5	1,5	1,4	62214 2RS	-
	2,1	2	2,65	6314 ZZ	6314 Z
	2,1	2	2,65	6314 2RS	6314 RS
	2,1	2	3,75	62314 2RS	-
75	0,6	0,6	0,15	61815 ZZ	-

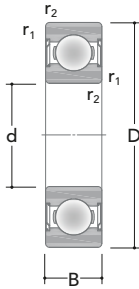

ZZ

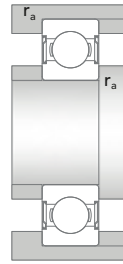

Main dimensions			Basic load ratings		Fatigue load limit C_u	Speed ratings		Designation
d	D	B	Dynamic C	Static C_0		Reference	Limiting ⁽¹⁾	Standard design
[mm]			[kN]			[rpm]		
75	95	10	12,95	14,1	0,61	-	3700	61815
(cont.)	105	16	24,44	22	0,984	12000	5900	61915
	105	16	24,44	22	0,984	-	3300	61915
	115	20	41,6	33,3	1,459	10900	5600	6015
	115	20	41,6	33,3	1,459	-	3100	6015
	130	25	69,59	48,3	2,02	9300	4800	6215
	130	25	69,59	48,3	2,02	-	3000	6215
	160	37	120,19	75,1	3	8200	4200	6315
	160	37	120,19	75,1	3	-	2500	6315
80	100	10	13,13	14,8	0,646	11800	5700	61816
	100	10	13,13	14,8	0,646	-	3300	61816
	110	16	25,6	20,3	1,04	11300	5500	61916
	110	16	25,6	20,3	1,04	-	2900	61916
	125	22	48,91	39,9	1,677	10200	5000	6016
	125	22	48,91	39,9	\	-	3000	6016
	140	26	72,8	54,8	2,244	8700	4300	6216
	140	26	72,8	54,8	2,244	-	2700	6216
	170	39	131,3	85	3,315	8000	3900	6316
	170	39	131,3	85	3,315	-	2400	6316
85	110	13	19,7	20,4	0,889	10900	5600	61817
	110	13	19,7	20,4	0,889	-	3100	61817
	130	22	52	42,5	1,76	9900	5000	6017
	130	22	52	42,5	1,76	-	2800	6017
	150	28	87,97	63,8	2,525	8400	4200	6217
	150	28	87,97	63,8	2,45	-	2500	6217
	180	41	142,8	95,1	3,586	7300	3600	6317
	180	41	142,8	95,1	3,586	-	2200	6317
90	115	13	19,89	21,6	0,897	10200	5100	61818
	115	13	19,89	21,6	0,897	-	2900	61818
	140	24	59,29	49,8	1,98	9300	4500	6018

⁽¹⁾ Bearings featuring ZZ or 2RS suffixes may reach lower speed values

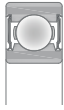

2RS

Dimensions			Mass	Designation	
d	r _{1,2min}	r _{amax}		Bearing sealed on	
[mm]			[kg]	both sides	one side
75	0,6	0,6	0,15	61815 2RS	-
(cont.)	1	1	0,37	61915 ZZ	-
	1	1	0,37	61915 2RS	-
	1,1	1	0,7	6015 ZZ	6015 Z
	1,1	1	0,7	6015 2RS	6015 RS
	1,5	1,5	1,25	6215 ZZ	6215 Z
	1,5	1,5	1,25	6215 2RS	6215 RS
	2,1	2	3,15	6315 ZZ	6315 Z
	2,1	2	3,15	6315 2RS	6315 RS
	80	0,6	0,6	0,15	61816 ZZ
0,6		0,6	0,15	61816 2RS	-
1		1	0,4	61916 ZZ	-
1		1	0,4	61916 2RS	-
1,1		1	0,91	6016 ZZ	6016 Z
1,1		1	0,91	6016 2RS	6016 RS
2		2	1,55	6216 ZZ	6216 Z
2		2	1,55	6216 2RS	6216 RS
2,1		2	3,75	6316 ZZ	6316 Z
2,1		2	3,75	6316 2RS	6316 RS
85	1	1	0,27	61817 ZZ	-
	1	1	0,27	61817 2RS	-
	1,1	1	0,96	6017 ZZ	6017 Z
	1,1	1	0,96	6017 2RS	6017 RS
	2	2	1,9	6217 ZZ	6217 Z
	2	2	1,9	6217 2RS	6217 RS
	3	2,5	4,4	6317 ZZ	6317 Z
	3	2,5	4,4	6317 2RS	6317 RS
90	1	1	0,28	61818 ZZ	-
	1	1	0,28	61818 2RS	-
	1,5	1,5	1,2	6018 ZZ	6018 Z

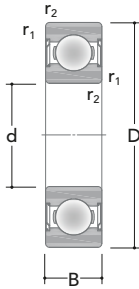

ZZ

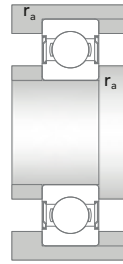

Main dimensions			Basic load ratings		Fatigue load limit C_u	Speed ratings		Designation
d	D	B	Dynamic C	Static C_0		Reference	Limiting ⁽¹⁾	Standard design
[mm]			[kN]			[rpm]		
90 (cont.)	140	24	59,29	49,8	1,98	-	2600	6018
	160	30	102,01	72,8	2,828	7700	4000	6218
	160	30	102,01	72,8	2,828	-	2400	6218
	190	43	154,02	107	3,876	7100	3500	6318
	190	43	154,02	107	3,876	-	2200	6318
95	120	13	19,9	22,8	0,949	10100	4900	61819
	120	13	19,9	22,8	0,949	-	2800	61819
	130	18	19,9	22,7	0,949	-	2800	61919
	145	24	62,43	53,8	2,101	8600	4500	6019
	145	24	62,43	53,8	2,101	-	2600	6019
	170	32	112,86	80,7	3	7300	3600	6219
	170	32	112,86	80,7	3	-	2200	6219
	200	45	160,59	117	4,233	6400	3300	6319
	200	45	160,59	117	4,233	-	2000	6319
100	125	13	18,16	18,1	0,941	9400	4800	61820
	125	13	18,16	18,1	0,941	-	2800	61820
	150	24	64,34	53	2,04	8800	4100	6020
	150	24	64,34	53	2,04	-	2400	6020
	180	34	128,27	92,7	3,283	7100	3400	6220
	180	34	128,27	92,7	3,283	-	2200	6220
	215	47	174	138	4,845	6100	3200	6320
	215	47	174	138	4,845	-	1800	6320
105	130	13	21,22	19,3	1,02	9000	4700	61821
	130	13	21,22	19,3	1,02	-	2500	61821
	160	26	76,86	64,6	2,448	8000	3900	6021
	160	26	76,86	64,6	2,448	-	2200	6021
	190	36	140	103	3,687	6600	3300	6221
	190	36	140	103	3,687	-	2000	6221
	225	49	182	150	5,049	5900	2900	6321

⁽¹⁾ Bearings featuring ZZ or 2RS suffixes may reach lower speed values

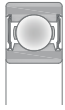

2RS

Dimensions			Mass	Designation	
d	r _{1,2min}	r _{amax}		Bearing sealed on	
[mm]			[kg]	both sides	one side
90 (cont.)	1,5	1,5	1,2	6018 2RS	6018 RS
	2	2	2,3	6218 ZZ	6218 Z
	2	2	2,3	6218 2RS	6218 RS
	3	2,5	5,1	6318 ZZ	6318 Z
	3	2,5	5,1	6318 2RS	6318 RS
95	1	1	0,3	61819 ZZ	-
	1	1	0,3	61819 2RS	-
	1,1	1	0,65	61919 2RS	-
	1,5	1,5	1,25	6019 ZZ	6019 Z
	1,5	1,5	1,25	6019 2RS	6019 RS
	2,1	2	2,75	6219 ZZ	6219 Z
	2,1	2	2,75	6219 2RS	6219 RS
	3	2,5	5,85	6319 ZZ	6319 Z
3	2,5	5,85	6319 2RS	6319 RS	
100	1	1	0,31	61820 ZZ	-
	1	1	0,31	61820 2RS	61820 RS
	1,5	1,5	1,35	6020 ZZ	6020 Z
	1,5	1,5	1,35	6020 2RS	6020 RS
	2,1	2	3,3	6220 ZZ	6220 Z
	2,1	2	3,3	6220 2RS	6220 RS
	3	2,5	7,3	6320 ZZ	6320 Z
	3	2,5	7,3	6320 2RS	6320 RS
105	1	1	0,32	61821 ZZ	-
	1	1	0,32	61821 2RS	61821 RS
	2	2	1,65	6021 ZZ	6021 Z
	2	2	1,65	6021 2RS	6021 RS
	2,1	2	3,95	6221 ZZ	6221 Z
	2,1	2	3,95	6221 2RS	6221 RS
	3	2,5	8,25	6321 ZZ	6321 Z

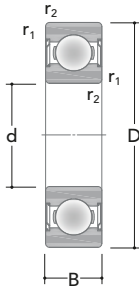

ZZ

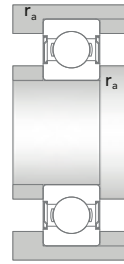

Main dimensions			Basic load ratings		Fatigue load limit C_u	Speed ratings		Designation
d	D	B	Dynamic C	Static C_0		Reference	Limiting ⁽¹⁾	Standard design
[mm]			[kN]			[rpm]		
110	140	16	28,38	25,5	1,238	8600	4100	61822
	140	16	28,38	25,5	1,238	-	2400	61822
	170	28	84,35	72,4	2,448	7200	3800	6022
	170	28	84,35	72,4	2,448	-	2200	6022
	200	38	154,02	117	4,08	6100	3200	6222
	200	38	154,02	117	4,08	-	1800	6222
	240	50	207,06	177	5,814	5400	2800	6322
	240	50	207,06	177	5,814	-	1600	6322
120	150	16	29,39	27,7	1,303	7800	4000	61824
	150	16	29,39	27,7	1,303	-	2200	61824
	180	28	87,52	79,1	2,778	6800	3500	6024
	180	28	87,52	79,1	2,778	-	1900	6024
	215	40	147,46	117	3,9	5700	2900	6224
	215	40	147,46	117	3,9	-	1700	6224
	260	55	210,08	185	5,586	5000	2500	6324
	260	55	210,08	185	5,586	-	1500	6324
130	165	18	38,08	42,7	1,632	7300	3500	61826
	165	18	38,08	42,7	1,632	-	1900	61826
	200	33	110	99,9	3,417	6400	3100	6026
	200	33	110	99,9	3,417	-	1800	6026
	230	40	157,56	130	4,15	5300	2800	6226
	230	40	157,56	130	4,15	-	1600	6226
140	175	18	39,78	46,4	1,677	7000	3400	61828
	175	18	39,78	46,4	1,677	-	1800	61828
	210	33	113,22	107	3,519	6200	2900	6028
	210	33	113,22	107	3,519	-	1700	6028
150	225	35	127,5	123	3,939	5500	2800	6030
	225	35	127,5	123	3,939	-	1600	6030

⁽¹⁾ Bearings featuring ZZ or 2RS suffixes may reach lower speed values

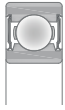

2RS

Dimensions			Mass	Designation	
d	r _{1,2min}	r _{amax}		Bearing sealed on	
[mm]			[kg]	both sides	one side
110	1	1	0,6	61822 ZZ	-
	1	1	0,6	61822 2RS	-
	2	2	2,05	6022 ZZ	6022 Z
	2	2	2,05	6022 2RS	6022 RS
	2,1	2	4,5	6222 ZZ	6222 Z
	2,1	2	4,5	6222 2RS	6222 RS
	3	2,5	9,7	6322 ZZ	6322 Z
	3	2,5	9,7	6322 2RS	6322 RS
120	1	1	0,65	61824 ZZ	-
	1	1	0,65	61824 2RS	61824 RS
	2	2	2,2	6024 ZZ	6024 Z
	2	2	2,2	6024 2RS	6024 RS
	2,1	2	5,35	6224 ZZ	6224 Z
	2,1	2	5,35	6224 2RS	6224 RS
	3	2,5	12,7	6324 ZZ	6324 Z
	3	2,5	12,7	6324 2RS	6324 RS
130	1,1	1	0,93	61826 ZZ	-
	1,1	1	0,93	61826 2RS	61826 RS
	2	2	3,35	6026 ZZ	6026 Z
	2	2	3,35	6026 2RS	6026 RS
	3	2,5	6	6226 ZZ	6226 Z
	3	2,5	6	6226 2RS	6226 RS
140	1,1	1	0,99	61828 ZZ	-
	1,1	1	0,99	61828 2RS	61828 RS
	2	2	3,6	6028 ZZ	6028 Z
	2	2	3,6	6028 2RS	6028 RS
150	2,1	2	4,35	6030 ZZ	6030 Z
	2,1	2	4,35	6030 2RS	6030 RS

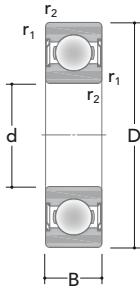

ZZ

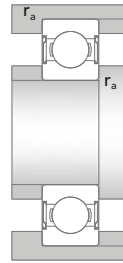

Main dimensions			Basic load ratings		Fatigue load limit C_u	Speed ratings		Designation
d	D	B	Dynamic C	Static C_0		Reference	Limiting ⁽¹⁾	Standard design
[mm]			[kN]			[rpm]		
160	240	38	141,57	143	4,343	5200	2500	6032
	240	38	141,57	143	4,343	-	1500	6032

⁽¹⁾ Bearings featuring ZZ or 2RS suffixes may reach lower speed values

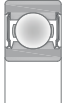

2RS

Dimensions			Mass	Designation	
d	r _{1,2min}	r _{amax}		Bearing sealed on	
[mm]			[kg]	both sides	one side
160	2,1	2	5,35	6032 ZZ	6032 Z
	2,1	2	5,35	6032 2RS	6032 RS

Angular contact ball bearings

The angular contact ball bearings (ACBBs) produced by RKB are used in a wide array of machines where combined loads, high speeds and runout accuracy are required. Available in single or double row configuration, they can be manufactured with different types of cage (machined brass, pressed steel or polyamide) and dimensional precisions.

Single row ACBBs can be directly paired by RKB in face-to-face (DF) or back-to-back (DB) configuration, depending on load conditions, presence of tilting moments and misalignment magnitude in the application.



Single row angular contact ball bearings

Single row angular contact ball bearings

Misalignment

For single row angular contact ball bearing is not possible to determine a unique value of the shaft and housing misalignment. Permissible misalignment depends on several factors such as: the bearing size, internal axial clearance, arrangement, loads and moments

acting on it. A limited misalignment can be accommodated by paired bearings in back-to-back arrangement, even if the stresses inside the balls increase and consequently the bearing life will be reduced.

Minimum load

The minimum radial load is requested for single row angular contact ball bearing to guarantee an adequate operating condition, especially in particularly difficult working conditions like: high speed, high acceleration and sudden changes of direction. In these operating conditions, a skidding movement between the balls and raceways can be generated by the inertial forces, influencing negatively the bearing life.

Minimum radial load for single bearing and paired bearings in tandem arrangement can be theoretically estimated using this formula:

$$\frac{F_m}{C_r} > 0,015$$

where:

- F_m minimum radial load, [kN];
- C_r basic dynamic radial load, [kN].

Usually, the minimum radial load is reached or surpassed by the weight of the components supported by the bearing together with the loads acting on it, otherwise supplementary radial load must be applied on the single row angular contact ball bearing. In application where a starting up at a low temperature is planned or a lubricant with high viscosity is used, a larger value of the minimum radial load is required.

It is possible to apply an axial preload for single bearing and paired bearings in tandem arrangement by adjusting one ring against the other one or by using springs.

Designs and variants

Type M

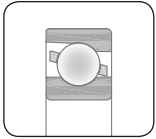

- One-piece inner and outer ring
- One-piece machined brass cage guided on balls (M)
- Available with machined brass cage guided on inner ring (MB)
- Single (non-universal) bearing execution
- Suitable for very high operating speeds
- Available with 25°, 30° or 40° contact angle

Type DB

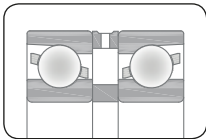

- Back-to-back arrangement (DB) of two ACBBs
- One-piece machined brass cage guided on balls (M)
- Preset or adjusted BEP on customer's request
- Available with machined brass cage guided on inner ring (MB)
- Available with inner and/or outer spacers featuring lubrication grooves and/or lubrication holes
- Stiffer arrangement to withstand tilting moments

Type DF

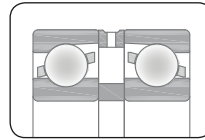

- Face-to-face arrangement (DF) of two ACBBs
- One-piece machined brass cage guided on balls (M)
- Preset or adjusted BEP on customer's request

Prefixes

ACBB	Out of standard single row angular contact ball bearing followed by drawing number
ACBBF	Out of standard single row angular contact ball bearing with flanged outer ring followed by drawing number

Suffixes

Internal design

A	Bearing with a 30° contact angle
AC	Bearing with a 25° contact angle
B	Bearing with a 40° contact angle

Suffixes

Cage

M	Step-type or straight-type machined brass cage guided on balls
MF	Machined steel cage guided on balls
MB	Machined brass cage guided on inner ring
MBS	Machined brass cage guided on inner ring with lubrication grooves in the guiding surface
TN or ATN	Molded polyamide cage (PA66) guided on balls
TN9	Molded glass fiber-reinforced polyamide cage (PA66-GF25) guided on balls

Suffixes

Accuracy, clearance, running

A... - ...	Special axial internal clearance. The two numbers immediately following the A give minimum and maximum axial internal clearance in μm
A...	Special axial internal clearance. The number immediately following the A gives mean axial internal clearance in μm
U	Bearing for universal paired mounting. When in back-to-back or face-to-face arrangement there will be axial internal clearance
GA	Bearing for paired mounting. When in back-to-back or face-to-face arrangement there will be a light preload
GB	Bearing for paired mounting. When in back-to-back or face-to-face arrangement there will be a moderate preload
GC	Bearing for paired mounting. When in back-to-back or face-to-face arrangement there will be a heavy preload
CA	Bearing for paired mounting. When in back-to-back or face-to-face arrangement the axial internal clearance will be smaller than normal (CB)
CB	Bearing for paired mounting. When in back-to-back or face-to-face arrangement the axial internal clearance will be normal
CC	Bearing for paired mounting. When in back-to-back or face-to-face arrangement the axial internal clearance will be greater than normal (CB)

Suffixes	External design
Z	Shield on one side
ZZ or 2Z	Shield on both sides
N1	One locating slot in outer ring
N2	Two locating slots in outer ring

Suffixes	Set
DB	Two bearings matched for mounting back-to-back
DF	Two bearings matched for mounting face-to-face
DT	Two bearings matched for mounting in tandem

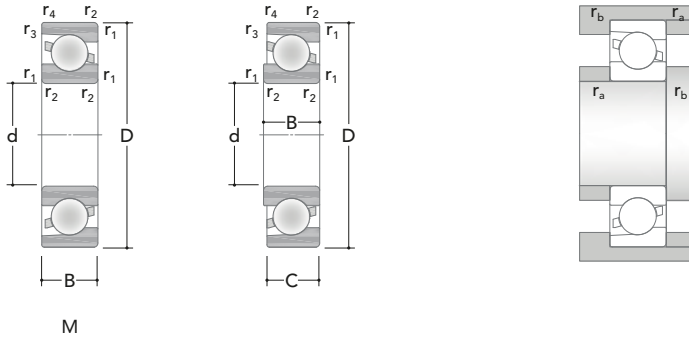

Main dimensions				Basic load ratings		Fatigue load limit C_u	Speed ratings		Designation
d	D	B	C	Dynamic C	Static C_0		Reference	Limiting	Standard design
[mm]				[kN]		[rpm]			
10	30	9	-	7,09	3,34	0,140	28200	28200	7200
12	32	10	-	7,69	3,76	0,160	23900	23400	7201
	37	12	-	10,50	4,98	0,210	22300	22600	7301
15	35	11	-	10,10	5,25	0,200	17300	36400	7202
	42	13	-	13,30	6,57	0,270	18200	18800	7302
17	40	12	-	11,10	5,74	0,250	20000	19800	7203
	47	14	-	16,10	8,25	0,350	17700	17700	7303
20	47	14	-	14,60	8,04	0,340	17500	17900	7204
	52	15	-	18,60	9,92	0,420	16400	16400	7304
25	52	15	-	15,30	9,88	0,420	16000	15800	7205
	62	17	-	26,00	15,3	0,660	13800	14000	7305
30	62	16	-	24,50	15,4	0,650	13200	12900	7206
	72	19	-	35,50	21,2	0,900	11800	12100	7306
35	72	17	-	30,70	20,5	0,870	10800	10800	7207
	80	21	-	41,10	26,4	1,140	10300	9900	7307
40	80	18	-	36,80	25,9	1,100	10100	10200	7208
	90	23	-	50,00	32,2	1,360	9100	9200	7308
45	85	19	-	37,60	28,2	1,210	9100	9300	7209
	100	25	-	61,60	40	1,710	8200	8400	7309
50	90	20	-	40,40	30,9	1,320	8500	8300	7210
	110	27	-	73,50	50,2	2,130	7200	7300	7310
55	100	21	-	50,00	39,8	1,650	7400	7300	7211

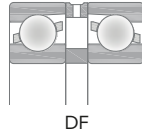
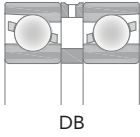

Dimensions					Mass	Designation
d	r _{1,2min}	r _{3,4min}	r _{amax}	r _{bmax}		Standard design
[mm]					[kg]	
10	0,6	0,3	0,6	0,3	0,03	7200
12	0,6	0,3	0,6	0,3	0,036	7201
	1	0,6	1	0,6	0,06	7301
15	0,6	0,3	0,6	0,3	0,045	7202
	1	0,6	1	0,6	0,08	7302
17	0,6	0,6	0,6	0,6	0,065	7203
	1	0,6	1	0,6	0,11	7303
20	1	0,6	1	0,6	0,11	7204
	1,1	0,6	1	0,6	0,14	7304
25	1	0,6	1	0,6	0,13	7205
	1,1	0,6	1	0,6	0,23	7305
30	1	0,6	1	0,6	0,2	7206
	1,1	0,6	1	0,6	0,34	7306
35	1,1	0,6	1	0,6	0,28	7207
	1,5	1	1,5	1	0,45	7307
40	1,1	0,6	1	0,6	0,37	7208
	1,5	1	1,5	1	0,68	7308
45	1,1	0,6	1	0,6	0,42	7209
	1,5	1	1,5	1	0,91	7309
50	1,1	0,6	1	0,6	0,47	7210
	2	1	2	1	1,1	7310
55	1,5	1	1,5	1	0,62	7211

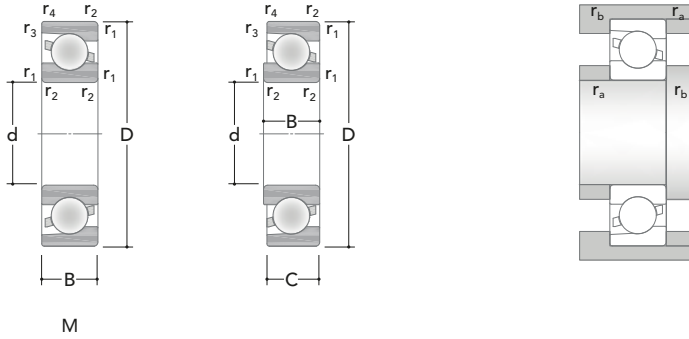

Main dimensions				Basic load ratings		Fatigue load limit	Speed ratings		Designation
d	D	B	C	Dynamic C	Static C ₀	C _u	Reference	Limiting	Standard design
[mm]				[kN]			[rpm]		
55	120	29	-	85,90	59	2,510	6500	6300	7311
(cont.)									
60	110	22	-	59,80	49,1	2,080	7000	6800	7212
	130	31	-	104,00	75,4	3,150	6200	6000	7312
65	120	23	-	68,10	56,1	2,410	6200	6200	7213
	140	33	-	117,20	84,9	3,580	5800	5800	7313
70	125	24	-	72,80	62,8	2,670	5900	5700	7214
	150	35	-	127,00	96,4	3,840	5200	5200	7314
75	130	25	-	72,80	64,5	2,660	5700	5700	7215
	160	37	-	132,00	104	4,150	5000	4800	7315
80	140	26	-	84,20	74,3	3,020	5000	5200	7216
	170	39	-	140,10	118	4,500	4600	4700	7316
85	150	28	-	103,00	88,3	3,480	4900	4800	7217
	180	41	-	156,00	131	4,860	4400	4400	7317
90	160	30	-	113,70	102	3,920	4600	4700	7218
	190	43	-	169,30	145	5,260	4200	4100	7318
95	170	32	-	124,00	116	4,300	3900	4200	7219
	200	45	-	178,20	161	5,630	3900	3900	7319
100	180	34	-	143,0	132	4,680	4100	4200	7220
	215	47	-	211,70	206	6,880	3600	3800	7320
105	190	36	-	153,00	148	5,130	3900	3900	7221
	225	49	-	218,20	204	6,820	3400	3500	7321
110	170	21	-	76,1	82,4	2,980	2700	3600	307536

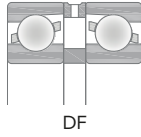
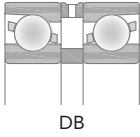

Dimensions					Mass	Designation
d	r _{1,2min}	r _{3,4min}	r _{amax}	r _{bmax}		Standard design
[mm]					[kg]	
55	2	1	2	1	1,4	7311
(cont.)						
60	1,5	1	1,5	1	0,8	7212
	2,1	1,1	2	1	1,75	7312
65	1,5	1	1,5	1	1	7213
	2,1	1,1	2	1	2,15	7313
70	1,5	1	1,5	1	1,1	7214
	2,1	1,1	2	1	2,65	7314
75	1,5	1	1,5	1	1,2	7215
	2,1	1,1	2	1	3,2	7315
80	2	1	2	1	1,45	7216
	2,1	1,1	2	1	3,8	7316
85	2	1	2	1	1,85	7217
	3	1,1	2,5	1	4,45	7317
90	2	1	2	1	2,3	7218
	3	1,1	2,5	1	5,2	7318
95	2,1	1,1	2	1	2,7	7219
	3	1,1	2,5	1	6,05	7319
100	2,1	1,1	2	1	3,3	7220
	3	1,1	2,5	1	7,5	7320
105	2,1	1,1	2	1	3,95	7221
	3	1,1	2,5	1	8,55	7321
110	1	1	1	1	1,7	307536

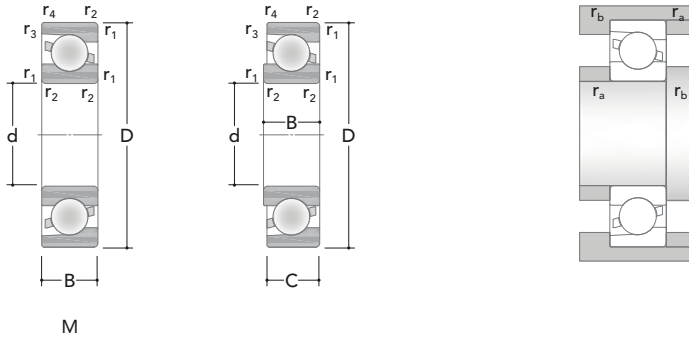

Main dimensions				Basic load ratings		Fatigue load limit	Speed ratings		Designation
d	D	B	C	Dynamic C	Static C ₀	C _u	Reference	Limiting	Standard design
[mm]				[kN]			[rpm]		
110	200	38	-	159,7	155	5,270	3600	3600	7222
(cont.)	240	50	-	235,2	245	7,800	3400	3300	7322
120	180	28	-	88,8	91,6	3,150	3600	3600	7024
	215	40	-	165,0	162	5,270	3100	3300	7224
	260	55	-	236,00	248	7,590	2800	2800	7324
130	230	40	-	186,00	193	6,100	2900	3100	7226
	280	58	-	276,00	299	8,820	2600	2600	7326
140	210	33	-	116,0	128	4,120	2900	3000	7028
	250	42	-	197,0	210	6,340	2700	2700	7228
	300	62	-	296,0	343	9,740	2300	2400	7328
150	210	28	25	98,0	111	3,620	1700	2600	466895/307377
	225	35	-	130,0	144	4,490	2700	2900	7030
	270	45	-	216,00	239	6,920	2400	2500	7230
	320	65	-	339,00	390	10,800	2200	2200	7330
160	215	28	-	82,0	108	3,340	1800	2500	466896
	240	38	-	142,0	164	4,940	1600	2300	7032
	290	48	-	252,0	296	8,390	2200	2300	7232
170	260	42	-	175,00	203	5,820	2300	2500	7034
	310	52	-	281,00	343	9,440	2200	2300	7234
	360	72	-	394,0	482	12,490	1800	2000	7334
175	235	30	27	100,0	120	3,840	1600	2300	468325
180	280	46	-	197,0	238	6,640	2200	2300	7036
	320	52	-	294,0	371	9,89	2000	2200	7236
	380	75	-	414,00	539	13,670	1900	1800	7336

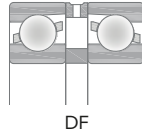
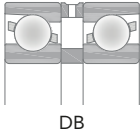

Dimensions					Mass	Designation
d	r _{1,2min}	r _{3,4min}	r _{amax}	r _{bmax}		Standard design
[mm]					[kg]	
110	2,1	1,1	2	1	4,6	7222
(cont.)	3	1,1	2,5	1	10	7322
120	2	1	2	1	2,4	7024
	2,1	1,1	2	1	5,9	7224
	3	1,5	2,5	1	14,5	7324
130	3	1,1	2,5	1	6,95	7226
	4	1,5	3	1,5	17	7326
140	2	1	2	1	3,85	7028
	3	1,1	2,5	1	8,85	7228
	4	1,5	3	1,5	21,5	7328
150	2	1	2	1	295	466895/307377
	2,1	1,1	2	1	4,7	7030
	3	1,1	2,5	1	11,5	7230
	4	1,5	3	1,5	26	7330
160	2	1	2	1	2,7	466896
	2,1	1,1	2	1	5,75	7032
	3	1,1	2,5	1	14	7232
170	2,1	1,1	2	1	7,65	7034
	4	1,5	3	1,5	17,5	7234
	4	2	3	2	36	7334
175	1,5	1	1,5	1	3,5	468325
180	2,1	1,1	2	1	10	7036
	4	1,5	3	1,5	18	7236
	4	2	3	2	42	7336

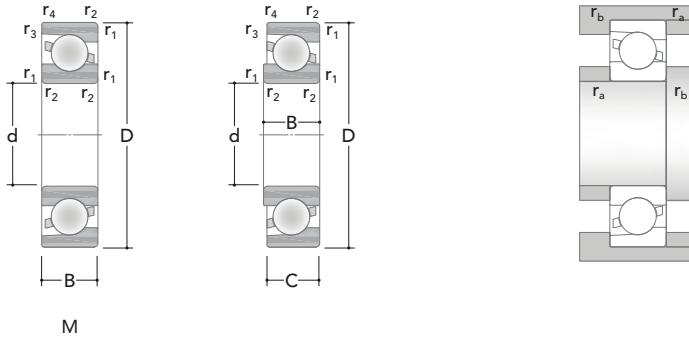

Main dimensions				Basic load ratings		Fatigue load limit C_u	Speed ratings		Designation
d	D	B	C	Dynamic C	Static C_0		Reference	Limiting	Standard design
[mm]				[kN]		[rpm]			
190	255	33	29	113,0	141	4,340	1500	2200	466880
	290	46	-	199,0	251	6,840	2200	2200	7038
	340	55	-	307,0	402	10,320	1800	2100	7238
	400	78	-	442,0	596	14,500	1700	1800	7338
200	310	51	-	225,0	290	7,64	2000	2100	7040
	360	58	-	319,00	424	10,850	1800	1800	7240
	420	80	-	457,00	648	15,430	1600	1600	7340
220	300	38	35	162,0	223	5,820	1400	1800	466931
	340	56	-	252,0	354	8,970	1800	1800	7044
	400	65	-	398,0	554	13,260	1600	1600	7244
	460	88	-	489,0	713	16,44	1500	1500	7344
240	360	56	-	257,00	373	9,100	1600	1700	7048
	440	72	-	357,00	537	12,430	1500	1500	7248
	500	95	-	570,0	808	14,650	1300	1400	7348
260	320	28	-	128,0	190	5,300	1300	1700	71852
	360	46	-	244,0	342	8,570	1600	1700	71952
	400	65	-	339,0	506	11,71	1400	1500	7052
	480	80	-	507,0	769	17,06	1300	1400	7252
280	350	33	-	156,00	240	6,300	1100	1500	71856
	380	46	-	252,0	378	9,250	1000	1500	71956
	420	65	-	338,0	540	12,200	1400	1500	7056
	500	80	-	506,0	836	17,730	1300	1300	7256
285	380	46	-	216,0	333	7,75	1000	1400	466951
300	460	74	-	413	685	14,900	1300	1400	7060
	540	65	-	547,0	928	19,260	790	1200	7260

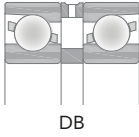

DB

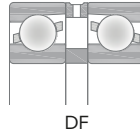

DF

Dimensions					Mass	Designation
d	r _{1,2min}	r _{3,4min}	r _{amax}	r _{bmax}		Standard design
[mm]					[kg]	
190	1,5	1	1,5	1	4,5	466880
	2,1	1,1	2	1	10,5	7038
	4	1,5	3	1,5	22	7238
	5	2	4	2	48,5	7338
200	2,1	1,1	2,1	1,1	18	7040
	4	1,5	3	1,5	25	7240
	5	2	4	2	53	7340
220	2	1	2	1	7,35	466931
	3	1,1	2,5	1,1	18	7044
	4	1,5	3	1,5	37	7244
	5	2	4	2	70	7344
240	3	1,1	2,5	1,1	19	7048
	4	1,5	3	1,5	49	7248
	5	2	4	2	89,4	7348
260	2	1,1	2	1	4,85	71852
	2,1	1,1	2	1	13,5	71952
	4	1,5	3	1,5	30	7052
	5	2	4	2	66	7252
280	2	1	2	1	7,2	71856
	2,1	1,1	2	1	15	71956
	4	1,5	3	1,5	30	7056
	5	2	4	2	67,5	7256
285	2,1	1	2	1	14	466951
300	4	1,5	3	1,5	42,5	7060
	5	2,1	4	2	86,5	7260

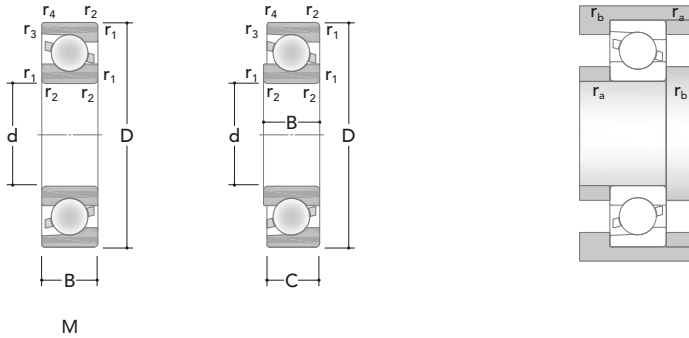

Main dimensions				Basic load ratings		Fatigue load limit C_u	Speed ratings		Designation
d	D	B	C	Dynamic C	Static C_0		Reference	Limiting	Standard design
[mm]				[kN]			[rpm]		
320	480	74	-	423,0	721	15,070	1200	1300	7064
	580	92	-	583,0	1000	20,000	770	1100	7264
335	450	56	-	278,0	478	10,36	1200	1300	466952
340	420	38	-	220	386	8,210	860	1300	71868
	460	56	-	338,0	579	12,370	1400	1400	71968
	520	82	-	493,0	885	18,030	1100	1200	7068
	620	92	-	695,0	1320	25,610	1010	990	7268
360	440	38	-	239,0	419	8,87	1400	1400	71872
	480	56	-	326,0	600	12,22	1300	1400	71972
	540	82	-	504	940	18,80	1100	1100	7072
	650	95	-	790	1560	22,680	1800	1600	7272
380	480	31	-	186,0	362,1	7,660	1200	1300	70876
	480	46	-	294,0	497	10,93	1200	1300	71876
	520	65	-	406,0	723	14,76	1200	1200	71976
	560	82	-	496,0	940	18,36	990	1100	7076
400	540	65	-	409	777	16,17	1100	1100	71980
	600	90	-	611,00	1170	22,210	880	1100	307238
	600	90	-	522,0	1030,2	19,200	920	1000	7080
	720	103	-	743,0	1480	26,150	820	870	7280
410	560	70	-	419,0	820	15,81	1000	1000	468431
420	560	65	-	408	795	16,26	1100	1100	71984
	620	90	-	592	1160	21,89	910	900	7084
440	650	94	-	626,0	1310	23,980	890	870	7088
460	580	37	-	262,0	554	10,29	1000	1000	70892

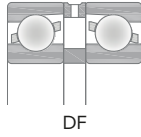
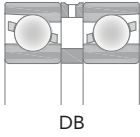

Dimensions					Mass	Designation
d	r _{1,2min}	r _{3,4min}	r _{amax}	r _{bmax}		Standard design
[mm]					[kg]	
320						7064
	5	2	4	2	110	7264
335	3	1	2,5	1	25,5	466952
340	2,1	1	2	1	10,5	71868
	3	1,1	2,5	1	24	71968
	5	2	4	2	59,5	7068
	6	3	5	2,5	125	7268
360	2,1	1,1	2	1	12	71872
	3	1,1	2,5	1	28,5	71972
	5	2	4	2	61,8	7072
	6	4	6	2,5	145	7272
380	2	1	2	1	14,4	70876
	2,1	1,1	2	1	18	71876
	4	1,5	3	1,5	40,5	71976
	5	2	4	2	65,5	7076
400	4	1,5	3	1,5	39	71980
	5	2	4	2	89,5	307238
	5	2	4	2	90,5	7080
	6	3	5	2,5	190	7280
410	4	1	3	1	49,5	468431
420	4	1,5	3	1,5	44,5	71984
	5	2	4	2	88	7084
440	6	3	5	2,5	100	7088
460	2,1	1	2	1	24,5	70892

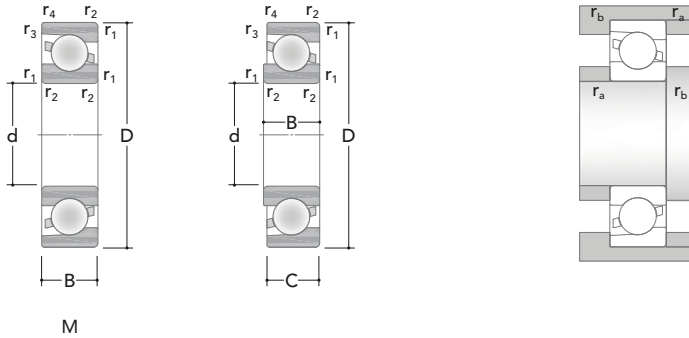

Main dimensions				Basic load ratings		Fatigue load limit C_u	Speed ratings		Designation
d	D	B	C	Dynamic C	Static C_0		Reference	Limiting	Standard design
[mm]				[kN]		[rpm]			
460 (cont.)	580	56	-	371,0	752	14,06	990	1030	71892
	620	74	-	512,0	1020	18,63	1000	1000	71992
	680	100	-	662	1430	25,72	830	850	7092
465	635	76	-	459,00	978	17,560	850	860	307352
480	700	100	-	687,0	1520	27,22	770	830	7096
500	620	37	-	282,0	617	10,95	920	910	708/500
	620	56	-	382,0	842	15,16	910	900	718/500
	670	78	-	553	1210	21,03	880	930	719/500
	720	100	-	686	1560	27,30	720	770	70/500
530	650	56	-	401,0	918	15,910	860	940	718/530
	710	82	-	618,0	1330	23,42	800	850	719/530
	760	100	-	702,0	1580	27,16	710	750	307368
	780	112	-	876,0	2150	35,41	700	720	70/530
540	630	45	-	260	597	10,55	770	830	311585
560	680	56	-	393,00	926	15,930	780	810	718/560
	750	85	-	604,0	1270	22,45	730	770	719/560
	820	115	-	881,0	2120	34,03	660	-	70/560
600	730	42	-	331,0	735	14,00	720	770	708/600
	730	60	-	458	1080	17,97	720	790	718/600
	800	90	-	729	1710	27,18	680	720	719/600
	870	118	-	884,00	2150	33,84	650	710	70/600
630	700	22	-	135,0	434	7,10	680	710	311712
				956,0	2401		530	640	
670	820	69	-	535	1280	22,12	650	680	718/670

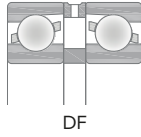
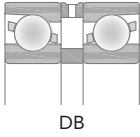

Dimensions					Mass	Designation
d	r _{1,2min}	r _{3,4min}	r _{amax}	r _{bmax}		Standard design
[mm]					[kg]	
460	3	3	2,5	2,5	35	71892
(cont.)	4	1,5	3	1,5	58	71992
	6	3	5	2,5	120	7092
465	4	4	3	3	70,5	307352
480	6	3	5	2,5	125	7096
500	2,1	1,1	2	1	26	708/500
	3	1,1	2,5	1	38	718/500
	5	2	4	2	78	719/500
	6	3	5	2,5	130	70/500
530	3	1,1	2,5	1	39,5	718/530
	5	2	4	2	92	719/530
	6	6	5	5	150	307368
	6	3	5	2,5	180	70/530
540	3	3	2,5	-	21,5	311585
560	3	1,1	2,5	1	41,5	718/560
	5	2	4	2	105	719/560
	6	3	5	2,5	203	70/560
600	3	1,1	2,5	1	38,5	708/600
	3	1,1	2,5	1	52	718/600
	5	2	4	2	125	719/600
	6	3	5	2,5	236	70/600
630	0,6	-	0,6	-	11,5	311712
	7,5	4	6	3	270	
670	4	1,5	3	1,5	77	718/670

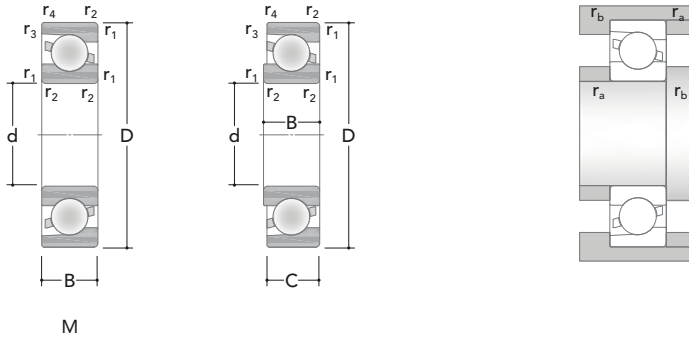

Main dimensions				Basic load ratings		Fatigue load limit C_u	Speed ratings		Designation
d	D	B	C	Dynamic C	Static C_0		Reference	Limiting	Standard design
[mm]				[kN]		[rpm]			
670	980	136	-	1170	3080	45,21	500	-	70/670
(cont.)									
710	870	74	-	585,0	1600	24,21	590	630	718/710
	950	106	-	852,0	2160	33,87	550	590	719/710
	1030	140	-	1202,0	3217,5	45,50	500	560	70/710
750	920	78	-	650	1800	25,91	560	590	718/750
	1090	150	-	1287	3590	51,15	490	520	70/750
762	889	63,5	-	453,0	1244,6	18,16	520	550	311576
800	1130	120	-	1102,0	3190	43,86	410	440	311745
	1150	155	-	1290,0	3720	50,96	420	-	70/800
850	1030	82	-	675	1841,4	28,38	460	500	718/850
	1220	165	-	1480,00	4560	60,43	370	-	70/850
900	1280	170	-	1544,0	4850	62,36	380	400	70/900
950	1360	180	-	1597,0	5180	65,25	360	380	70/950
1000	1220	100	-	923	2700	38,29	370	400	718/1000
	1320	103	-	840,00	2401	33,80	320	330	307101
	1420	185	-	1663,0	5300	65,76	340	350	70/1000
1060	1500	195	-	1697,0	5670	70,63	290	310	70/1060
1120	1360	106	-	1049	3700	44,40	310	330	718/1120
	1580	200	-	1686	5770	70,03	280	290	70/1120
1180	1660	212	-	1705,0	6110	72,43	260	250	70/1180
1250	1500	80	-	868,0	3510	46,80	250	270	708/1250

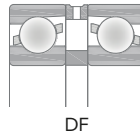
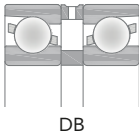

Dimensions					Mass	Designation
d	r _{1,2min}	r _{3,4min}	r _{amax}	r _{bmax}		Standard design
[mm]					[kg]	
670	7,5	4	6	3	353	70/670
(cont.)						
710	4	1,5	3	1,5	93,5	718/710
	6	3	5	2,5	195	719/710
	7,5	4	6	3	370	70/710
750	5	2	4	2	110	718/750
	7,5	4	6	3	445	70/750
762	2,1	2,1	2	2	58	311576
800	7,5	4	6	3	395	311745
	7,5	4	6	3	524	70/800
850	5	2	4	2	140	718/850
	7,5	4	6	3	626	70/850
900	7,5	4	6	3	665	70/900
950	7,5	4	6	3	805	70/950
1000	6	3	5	2,5	243	718/1000
	6	6	5	5	370	307101
	7,5	4	6	3	890	70/1000
1060	9,5	5	8	4	1050	70/1060
1120	6	3	5	2,5	320	718/1120
	9,5	5	8	4	1150	70/1120
1180	9,5	5	8	4	1350	70/1180
1250	6	3	5	2,5	295	708/1250

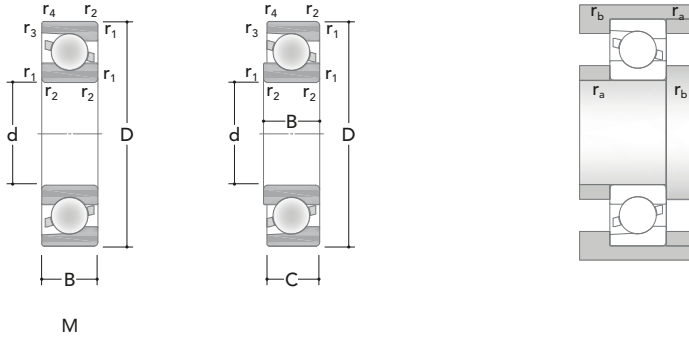

Main dimensions				Basic load ratings		Fatigue load limit	Speed ratings		Designation
d	D	B	C	Dynamic C	Static C ₀	C _u	Reference	Limiting	Standard design
[mm]				[kN]			[rpm]		
1250	1500	112	-	1117	3850	49,36	260	270	718/1250
(cont.)	1750	218	-	1816	6450	75,33	220	230	70/1250
1700	1900	80	-	975,00	4470	44,70	150	150	307756

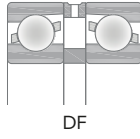
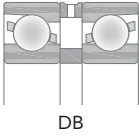

Dimensions					Mass	Designation
d	r _{1,2min}	r _{3,4min}	r _{amax}	r _{bmax}		Standard design
[mm]					[kg]	
1250	6	3	5	2,5	390	718/1250
(cont.)	9,5	5	8	4	1600	70/1250
1700	7,5	-	6	-	310	307756

Double row angular contact ball bearings

Can be considered in design similar to a pair of single row angular contact ball bearings in "O arrangement" or in a "X arrangement".

RKB double row angular contact ball bearings can accommodate thrust load as well as high radial load.

The bearings are normally used in arrangement requiring a rigid axial guidance. They can also withstand tilting moments.



Double row angular contact ball bearings

Misalignment

According to the bearing internal design of double row angular contact ball bearings any misalignment may shorten the bearing service life, as well as give an increase of rotation noise.

Minimum load

A minimum axial load is requested for a thrust ball bearing, like for all ball and roller bearings, to guarantee an adequate operating conditions, especially in critical application requirements like: high speed, high

acceleration and sudden changes of rotating direction. In these operating conditions a skidding between balls and raceways can be generated by the inertial forces, influencing negatively the bearing life.

The requested minimum axial load can be theoretically estimated as follows:

$$\frac{F_m}{C_r} > 0,015$$

where:

- F_m minimum radial load, [kN];
- C_r basic dynamic radial load, [kN].

Usually, the minimum radial load is reached or surpassed by the weight of the components supported by the bearing together with the loads acting on it, otherwise supplementary radial load must be applied on the single row angular contact ball bearing. In application where a starting up at a low temperature is planned or a lubricant with high viscosity is used, a larger value of the minimum radial load is required.

Designs and variants

Type DBA

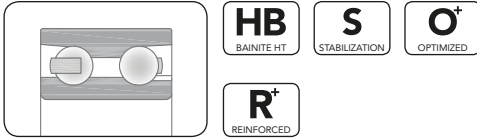

- Double row ACBB back-to-back arrangement (DB)
- Filling slot on inner ring
- Non-separable open design
- Moulded glass fiber reinforced polyamide snap-in cage guided on balls (TN)
- Available with lubrication holes in the inner ring
- Supports high combined loads

Type DB1

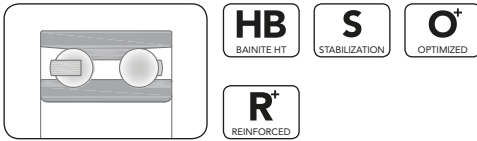

- Double row ACBB back-to-back arrangement (DB)
- Non-separable open design
- Moulded glass fiber reinforced polyamide snap-in cage guided on balls (TN)
- Available with lubrication holes in the inner ring
- Supports high combined loads

Type DB2



- Double row ACBB back-to-back arrangement (DB)
- Machined brass cage guided on inner ring (MB)

- Lubrication grooves and holes in outer ring
- Two-piece inner ring
- Supports high combined loads

Type DB3

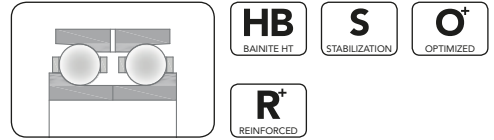

- Double row ACBB back-to-back arrangement (DB)
- Machined brass cage guided on inner ring (MB)
- Lubrication grooves and holes in outer ring
- Narrower outer ring compared to type DB2 design
- Two-piece inner ring
- Supports high combined loads

Type DF

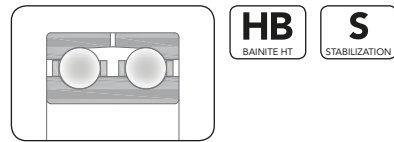

- Double row ACBB face-to-face arrangement (DF)
- Separable open design
- Machined brass cage guided on inner ring (MB)
- Lubrication grooves and holes in outer rings
- Supports high combined loads

Seal type DB/ZZ

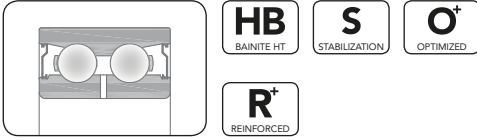

- Double row ACBB back-to-back arrangement (DB)
- Non-separable shielded design (ZZ)
- Moulded glass fiber reinforced polyamide snap-in cage guided on balls (TN)
- Available with lubrication holes in the inner ring
- Shielded type to keep the grease inside the bearing without compromising the limiting speed
- Supports high combined loads

Type DB/2RS

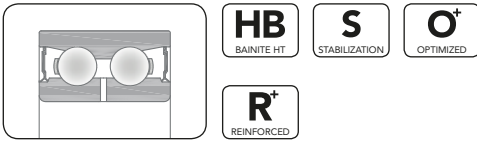

- Double row ACBB back-to-back arrangement (DB)
- Non-separable sealed design (2RS)
- Moulded glass fiber reinforced polyamide snap-in cage guided on balls (TN)
- Available with lubrication holes in the inner ring
- Sealed type to keep the grease inside the bearing without compromising the limiting speed
- Supports high combined loads

Suffixes	Internal Design
D	Two-piece inner ring
A	No filling slots
SP	Special or non-standard bearing

Suffixes	Cage
TN or ATN	Molded polyamide cage (PA66) guided on balls
TN9	Molded glass fiber-reinforced polyamide cage (PA66-GF25) guided on balls
M	Machined brass cage guided on balls
J	Pressed steel cage guided on balls

Suffixes	Accuracy, clearance, running
ABEC1	Approximated to tolerance class P0
ABEC3	Approximated to tolerance class P6
ABEC5	Approximated to tolerance class P5

Suffixes	External design
N	Snap ring groove in outer ring
N2	Two locating slots in outer ring
RS	Contact seal on one side
2RS	Contact seal on both sides
Z	Shield on one side
ZZ or 2Z	Shield on both sides

Suffixes	Set
DF or X or DFX	Double row angular contact ball bearing in X arrangement
DB	Double row angular contact ball bearing in O arrangement

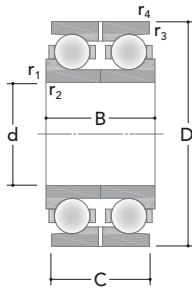

DB3

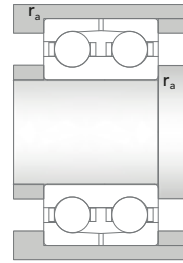

Main dimensions				Basic load ratings		Fatigue load limit	Speed ratings		Designation
d	D	B	C	Dynamic C	Static C ₀	C _u	Reference	Limiting	Standard design
[mm]				[kN]			[rpm]		
10	30	14	-	7,69	4,28	0,180	20500	21400	3200
12	32	15,9	-	10,30	5,51	0,240	18300	20500	3201
15	35	15,9	-	11,42	6,78	0,280	16000	16400	3202
	42	19	-	15,40	9,21	0,400	13400	14400	3302
17	40	17,5	-	14,16	8,8	0,370	13400	14500	3203
	47	22,2	-	21,82	12,6	0,540	12500	12300	3303
20	47	20,6	-	19,60	11,8	0,500	12700	12300	3204
	52	22,2	-	23,60	14,3	0,610	11400	11600	3304
25	52	20,6	-	21,17	14,1	0,590	11300	11000	3205
	62	25,4	-	32,00	20,1	0,850	10300	9900	3305
30	62	23,8	-	30,30	20,3	0,860	9000	9300	3206
	72	30,2	-	42,33	27,4	1,160	8100	8300	3306
35	72	27	-	39,20	27,9	1,180	8500	7900	3207
	80	34,9	-	50,96	35,5	1,500	7900	7800	3307
40	80	30,2	-	47,50	33,5	1,410	7400	7300	3208
	90	36,5	-	63,36	43,4	1,830	6900	6800	3308
45	85	30,2	-	49,98	38,9	1,630	7000	7000	3209
	100	39,7	-	75,00	52,2	2,210	6000	6100	3309
50	90	30,2	-	49,98	38,5	1,640	6200	6300	3210
	110	44,4	-	89,10	63,1	2,710	5300	5400	3310
55	100	33,3	-	59,40	46,9	1,970	5600	5500	3211
	120	49,2	-	110,88	81	3,430	4800	4700	3311

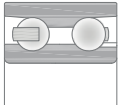

DBA

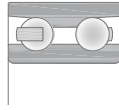

DB1

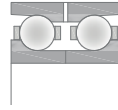

DB2

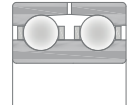

DF

Dimensions					Mass	Designation
d	r _{1,2min}	r _{3,4min}	r _{amax}	r _{bmax}		Standard design
[mm]					[kg]	
10	0,6	0,6	0,6	0,6	0,051	3200
12	0,6	0,6	0,6	0,6	0,058	3201
15	0,6 1	0,6 1	0,6 1	0,6 1	0,066 0,13	3202 3302
17	0,6 1	0,6 1	0,6 1	0,6 1	0,096 0,18	3203 3303
20	1 1,1	1 1,1	1 1	1 1	0,16 0,22	3204 3304
25	1 1,1	1 1,1	1 1	1 1	0,18 0,35	3205 3305
30	1 1,1	1 1,1	1 1	1 1	0,29 0,52	3206 3306
35	1,1 1,5	1,1 1,5	1 1,5	1 1,5	0,44 0,74	3207 3307
40	1,1 1,5	1,1 1,5	1 1,5	1 1,5	0,57 0,93	3208 3308
45	1,1 1,5	1,1 1,5	1 1,5	1 1,5	0,63 1,25	3209 3309
50	1,1 2	1,1 2	1 2	1 2	0,65 1,7	3210 3310
55	1,5 2	1,5 2	1,5 2	1,5 2	0,91 2,65	3211 3311

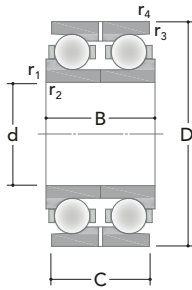

DB3

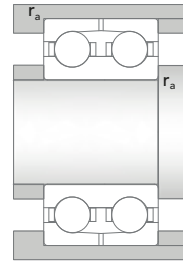

Main dimensions				Basic load ratings		Fatigue load limit C_u	Speed ratings		Designation
d	D	B	C	Dynamic C	Static C_0		Reference	Limiting	
[mm]				[kN]		[rpm]		Standard design	
60	110	36,5	-	73,50	57,4	2,450	5000	4900	3212
	130	54	-	125,73	94,9	4,050	4600	4700	3312
65	120	38,1	-	82,21	73,4	3,100	4000	4400	3213
	140	58,7	-	144,54	109	4,510	4000	4200	3313
70	125	39,7	-	90,17	79,1	3,360	3900	4100	3214
	150	63,5	-	163,00	125	5,000	4000	3900	3314
75	130	41,3	-	93,69	87	3,710	3900	4200	3215
	160	68,3	-	179,52	140	5,500	3700	3600	3315
80	140	44,4	-	107,06	93,4	3,830	3600	3800	3216
	170	68,3	-	194,93	155	5,960	3500	3500	3316
85	150	49,2	-	126,48	109	4,360	3200	3400	3217
	180	73	-	212,16	173	6,440	3300	3300	3317
90	160	52,4	-	131,30	119	4,510	3000	3300	3218
	190	73	-	212,16	179	6,360	3200	3100	3318
95	170	55,6	-	159,00	146	5,400	3000	3100	3219
	200	77,8	-	237,60	216	7,500	2800	3000	3319
100	170	60,3	-	132,3	144	5,810	2600	2900	305397
	180	60,3	-	176,2	216	7,810	2600	2800	3220
	215	82,6	-	260,10	353	11,970	2300	2600	3320
110	200	69,8	-	214,12	270	9,170	2500	2600	3222
	240	92,1	-	293,91	418	13,430	2200	2300	3322
120	190	66	-	190,0	236	7,870	2700	3200	309733

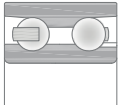

DBA

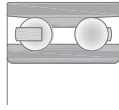

DB1

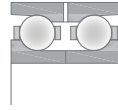

DB2

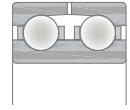

DF

Dimensions					Mass	Designation
d	r _{1,2min}	r _{3,4min}	r _{amax}	r _{bmax}		Standard design
[mm]					[kg]	
60	1,5	1,5	1,5	1,5	1,2	3212
	2,1	2,1	2	2	2,8	3312
65	1,5	1,5	1,5	1,5	1,75	3213
	2,1	2,1	2	2	4,1	3313
70	1,5	1,5	1,5	1,5	1,9	3214
	2,1	2,1	2	2	5,05	3314
75	1,5	1,5	1,5	1,5	2,1	3215
	2,1	2,1	2	2	5,55	3315
80	2	2	2	2	2,65	3216
	2,1	2,1	2	2	6,8	3316
85	2	2	2	2	3,4	3217
	3	3	2,5	2,5	8,3	3317
90	2	2	2	2	4,15	3218
	3	3	2,5	2,5	9,25	3318
95	2,1	2,1	2	2	5	3219
	3	3	2,5	2,5	11	3319
100	2,1	2,1	2	2	5,35	305397
	2,1	2,1	2	2	6,1	3220
	3	3	2,5	2,5	13,5	3320
110	2,1	2,1	2	2	8,8	3222
	3	3	2,5	2,5	19	3322
120	2	2	2	2	6,6	309733

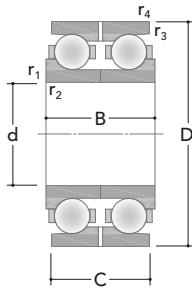

DB3

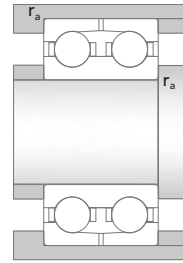

Main dimensions				Basic load ratings		Fatigue load limit	Speed ratings		Designation
d	D	B	C	Dynamic C	Static C ₀	C _u	Reference	Limiting	Standard design
[mm]				[kN]			[rpm]		
140	209,5	66	-	181,6	248	7,940	2600	2500	309515
150	225	73	-	191,0	273	7,730	1500	1800	305286
	230	70	-	201,0	285	9,000	2200	2700	305283
	240	84	-	253,51	335	10,250	2100	2700	305248
160	215	56	50	137,70	216	6,680	2200	2700	305608
	240	76	-	231,66	331	9,880	2000	2600	305183
170	260	84	-	281,0	399	11,430	1800	2400	305180
175	280	92	-	300,9	452	12,620	1900	2300	305351
180	250	70	-	194,0	281	8,530	1800	2400	305288
	250	70	-	186,2	282	8,560	1800	2300	305455
	259,5	66	-	257,00	396	11,240	1800	2400	305262
	280	92	-	322,19	479	13,370	1900	2400	305172
190	255	66	58	174,4	283	8,590	1900	2400	305609
	269,5	66	-	267,3	415	11,600	1700	2300	305338
	290	92	-	328,3	510	13,700	1800	2400	305178
200	279,5	76	-	246,8	374	10,24	1700	2100	305428
	280	76	-	239,58	360	9,850	1700	2100	305237
	280	80	-	239,58	376	10,290	1700	2200	305393
	289,5	76	-	294,0	468	12,710	1600	2000	305263
	310	96	-	365,2	551	14,760	1800	2400	305352
220	300	76	70	262,6	442	11,590	1500	2000	305610
	309,5	76	-	318,2	518	13,350	1500	1800	305272
230	329,5	80	-	351,00	592	15,100	1400	1800	305264

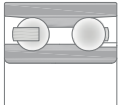

DBA

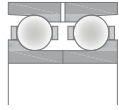

DB2

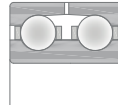

DF

Dimensions					Mass	Designation
d	r _{1,2min}	r _{3,4min}	r _{amax}	r _{bmax}		Standard design
[mm]					[kg]	
140	2	2	2	2	7,4	309515
150	2	2	2	2	9,5	305286
	2	2	2	2	10	305283
	2,1	2,1	2	2	16	305248
160	2	1,1	2	1	5,45	305608
	2,1	2,1	2	2	11	305183
170	2	2	2	2	15	305180
175	2,1	2,1	2	2	21	305351
180	2	2	2	2	10	305288
	2	2	2	2	9,95	305455
	2,1	2,1	2	2	11	305262
	2,1	2,1	2	2	21,9	305172
190	1,5	1,1	1,5	1	9	305609
	2,1	2,1	2	2	11	305338
	2,1	2,1	2	2	20,5	305178
200	2,1	2,1	2	2	13	305428
	2,1	2,1	2	2	12,5	305237
	2,1	2,1	2	2	14,5	305393
	2,1	2,1	2	2	15,5	305263
	3	3	2,5	2,5	25,5	305352
220	2	1,1	2	1	14,5	305610
	2,1	2,1	2	2	17	305272
230	2,1	2,1	2	2	21	305264

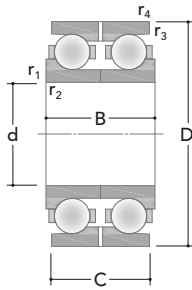

DB3

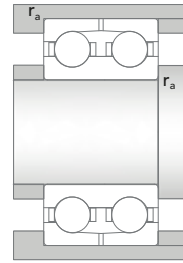

Main dimensions				Basic load ratings		Fatigue load limit C_u	Speed ratings		Designation Standard design
d	D	B	C	Dynamic C	Static C_0		Reference	Limiting	
[mm]				[kN]		[rpm]			
250	340	76	70	325,4	566	14,200	1400	1800	305611
260	369,5	92	-	397,0	696	16,960	1200	1500	305270
	400	130	-	431,6	727	17,11	1200	1500	305174
280	389,5	92	-	398,97	747	17,930	1200	1500	305269
650	780	84	-	540,0	1730	27,520	490	600	309984
900	1030	135	-	669,2	2510	33,960	330	400	311631
1000	1170	140	-	815,4	3170	41,11	280	400	311495

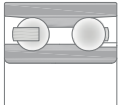

DBA

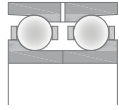

DB2

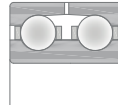

DF

Dimensions					Mass	Designation
d	r _{1,2min}	r _{3,4min}	r _{amax}	r _{bmax}		Standard design
[mm]					[kg]	
250	2,1	1,5	2	1,5	19	305611
260	2,1	2,1	2	2	30	305270
	4	4	3	3	56	305174
280	2,1	2,1	2	2	31,5	305269
650	4	2,1	3	2	81	309984
900	5	4	4	3	150	311631
1000	5	2,5	4	2	255	311495

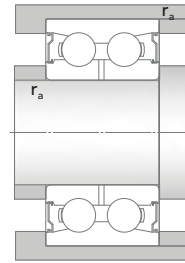
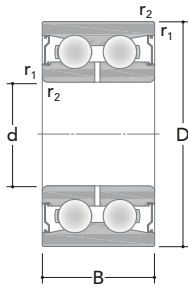

DB/ZZ

Main dimensions			Basic load ratings		Fatigue load limit C_u	Limiting speed		Designation
d	D	B	Dynamic C	Static C_0		Bearing featuring		
[mm]			[kN]			shields	seals	
						[rpm]		
10	30	14,3	7,76	4,28	0,18	21600	15800	3200
12	32	15,9	9,9	5,50	0,24	20200	13500	3201
15	35	15,9	11,2	6,80	0,28	16700	12700	3202
	42	19	15,4	9,20	0,4	14600	11300	3302
17	40	17,5	14,3	8,80	0,37	14200	10700	3203
	47	22,2	21,8	12,60	0,54	13000	9700	3303
20	47	20,6	19,8	11,80	0,5	12700	8900	3204
	52	22,2	23,6	14,30	0,61	12200	7900	3304
25	52	20,6	21,4	14,10	0,59	11200	7700	3205
	62	25,4	32,6	20,10	0,85	9900	6700	3305
30	62	23,8	29,3	20,30	0,86	9100	7100	3206
	72	30,2	41,5	27,40	1,16	8200	5900	3306
35	72	27	40,4	27,90	1,18	8200	5900	3207
	80	34,9	51,5	35,50	1,5	7800	5600	3307
40	80	30,2	48,5	36,10	1,41	7500	4900	3208
	90	36,5	65,3	43,40	1,83	6900	4500	3308
45	85	30,2	52	38,90	1,63	6800	4900	3209
	100	39,7	75	52,20	2,21	6100	4300	3309
50	90	30,2	51	38,50	1,64	6200	4500	3210
	110	44,4	89,1	63,10	2,71	5600	3900	3310
55	100	33,3	60,6	46,90	1,97	5800	4100	3211
	120	49,2	109,8	81,00	3,43	4800	3500	3311

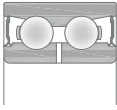

DB/2RS

Dimensions			Mass	Designation	
d	r _{1,2min}	r _{amax}		Bearing sealed on	
[mm]			[kg]	both sides	one side
10	0,6	0,6	0,051	3200 ZZ	3200 2RS
12	0,6	0,6	0,058	3201 ZZ	3201 2RS
15	0,6	0,6	0,066	3202 ZZ	3202 2RS
	1	1	0,13	3302 ZZ	3302 2RS
17	0,6	0,6	0,1	3203 ZZ	3203 2RS
	1	1	0,18	3303 ZZ	3303 2RS
20	1	1	0,16	3204 ZZ	3204 2RS
	1,1	1	0,22	3304 ZZ	3304 2RS
25	1	1	0,18	3205 ZZ	3205 2RS
	1,1	1	0,35	3305 ZZ	3305 2RS
30	1	1	0,29	3206 ZZ	3206 2RS
	1,1	1	0,52	3306 ZZ	3306 2RS
35	1,1	1	0,44	3207 ZZ	3207 2RS
	1,5	1,5	0,74	3307 ZZ	3307 2RS
40	1,1	1	0,57	3208 ZZ	3208 2RS
	1,5	1,5	0,93	3308 ZZ	3308 2RS
45	1,1	1	0,63	3209 ZZ	3209 2RS
	1,5	1,5	1,25	3309 ZZ	3309 2RS
50	1,1	1	0,65	3210 ZZ	3210 2RS
	2	2	1,7	3310 ZZ	3310 2RS
55	1,5	1,5	0,91	3211 ZZ	3211 2RS
	2	2	2,65	3311 ZZ	3311 2RS

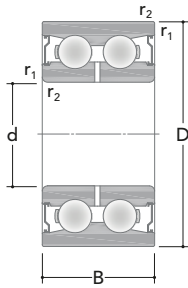

DB/ZZ

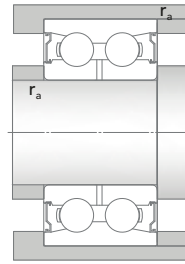

Main dimensions			Basic load ratings		Fatigue load limit C_u	Limiting speed		Designation
d	D	B	Dynamic C	Static C_0		Bearing featuring		
[mm]			[kN]			shields	seals	
						[rpm]		
60	110	36,5	74,2	57,40	2,45	5000	3600	3212
	130	54	124,5	94,90	4,05	4600	-	3312
65	120	38,1	80,6	73,40	3,1	4400	3300	3213
	140	58,7	143,1	109,00	4,51	4100	-	3313
70	125	39,7	90,2	79,10	3,36	4100	-	3214
	150	63,5	163	125,00	5	3800	-	3314
75	130	41,3	96,6	87,00	3,71	4100	-	3215
	160	68,3	172,5	140,00	5,5	3600	-	3315

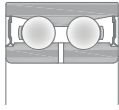

DB/2RS

Dimensions			Mass	Designation	
d	r _{1,2min}	r _{amax}		Bearing sealed on	
[mm]			[kg]	both sides	one side
60	1,5	1,5	1,2	3212 ZZ	3212 2RS
	2,1	2	2,8	3312 ZZ	-
65	1,5	1,5	1,75	3213 ZZ	3213 2RS
	2,1	2	4,1	3313 ZZ	-
70	1,5	1,5	1,9	3214 ZZ	-
	2,1	2	5,05	3314 ZZ	-
75	1,5	1,5	2,1	3215 ZZ	-
	2,1	2	5,6	3315 ZZ	-

Four-point contact ball bearings

Four-point contact ball bearings are single row angular contact ball bearings featuring raceways designed to accommodate thrust loads acting in both directions. However radial loads can be partially supported up to a proportional value of axial load. This kind of bearing requires less space in axial direction than double row bearings.

Normally single row four-point contact ball bearings supporting thrust load in both direction are mounted together with another pure radial bearings. In this case the four-point contact ball bearings are mounted with radial clearance in the housing and they act as pure thrust bearings.

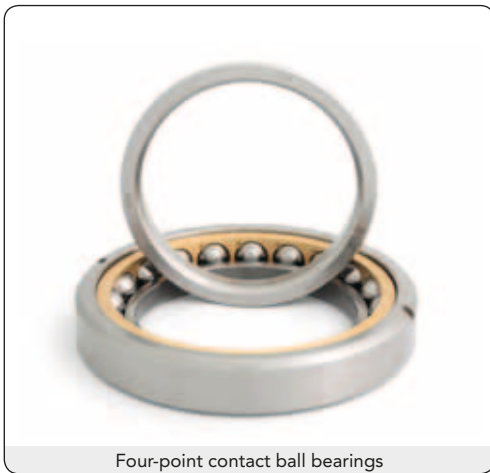

Four-point contact ball bearings

Minimum load

In order to operate properly four-point contact ball bearings have to be subject to a minimum axial load. The requested value should prevent a higher level of friction as well as assure the contact among rolling elements and raceways only in one point.

According to these concepts the minimum axial load can be theoretically estimated as follows:

$$\frac{F_{am}}{F_r} > 1,25$$

where:

- F_{am} minimum axial load, [kN];
- F_r radial dynamic bearing load, [kN].

Misalignment

Four-point contact ball bearings can compensate partially the misalignments. This property is strictly connected with the residual internal clearance in operation, as well as tilting moments applied on the bearing.

However misalignments increase the noise during rotation and reduce the service life of the bearing.

Designs and variants

Type Q

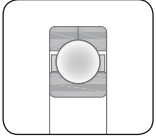
**HB**
BAINITE HT**S**
STABILIZATION

- Two-piece outer ring circumferentially split
- One-piece inner ring
- One-piece machined brass cage guided on inner ring (MB)
- Supports mainly axial loads
- Two locating slots (N2)

Type QJ

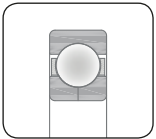
**HB**
BAINITE HT**S**
STABILIZATION

- One-piece outer ring
- Two-piece inner ring circumferentially split
- One-piece machined brass cage guided on outer ring (MA)
- Supports mainly axial loads
- Two locating slots (N2)

Suffixes	Cage
MA	Machined brass cage guided on outer ring
MB	Machined brass cage guided on inner ring

Suffixes	External design
N1	One locating slot in outer ring
N2	Two locating slots in outer ring



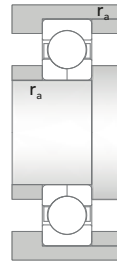
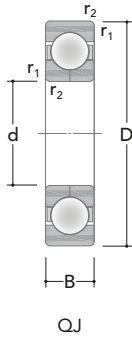

Main dimensions			Basic load ratings		Fatigue load limit C_u	Speed ratings		Designation
d	D	B	Dynamic C	Static C_0		Reference	Limiting	Standard design
[mm]			[kN]			[rpm]		
15	35	11	12,7	8,19	0,35	19800	33100	QJ 202
17	40	12	17,17	11,40	0,48	19400	27000	QJ 203
	47	14	23,87	14,90	0,64	15000	24900	QJ 303
20	52	15	31,36	21,50	0,93	16700	21800	QJ 304
25	52	15	26,46	21,00	0,89	14600	20700	QJ 205
	62	17	42,93	29,90	1,27	14100	18000	QJ 305
30	62	16	36,75	30,40	1,29	12900	17500	QJ 206
	72	19	53	41,40	1,76	11000	15800	QJ 306
35	72	17	48,02	41,50	1,76	10900	15000	QJ 207
	80	21	64,64	50,10	2,12	10300	14000	QJ 307
40	80	18	55,44	48,60	2,06	10100	13200	QJ 208
	90	23	79,56	64,00	2,7	9100	12500	QJ 308
45	85	19	61,74	55,80	2,35	8800	12700	QJ 209
	100	25	102	81,60	3,49	8200	10600	QJ 309
50	90	20	64,19	59,90	2,55	8000	11600	QJ 210
	110	27	116	98,90	4,2	7000	9700	QJ 310
55	100	21	85	83,00	3,55	7500	9700	QJ 211
	120	29	138,37	117,00	4,96	6600	9400	QJ 311
60	110	22	95,54	92,50	3,98	6800	9000	QJ 212
	130	31	154,44	136,00	5,81	6300	8300	QJ 312
65	120	23	111,1	110,00	4,67	6000	8600	QJ 213
	140	33	174,24	155,00	6,51	5500	7700	QJ 313

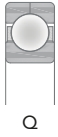

Dimensions			Mass	Designation
d	r _{1,2min}	r _{amax}		Standard design
[mm]			[kg]	
15	0,6	0,6	0,062	QJ 202
17	0,6	0,6	0,082	QJ 203
	1	1	0,14	QJ 303
20	1,1	1	0,18	QJ 304
25	1	1	0,16	QJ 205
	1,1	1	0,29	QJ 305
30	1	1	0,24	QJ 206
	1,1	1	0,42	QJ 306
35	1,1	1	0,35	QJ 207
	1,5	1,5	0,57	QJ 307
40	1,1	1	0,45	QJ 208
	1,5	1,5	0,78	QJ 308
45	1,1	1	0,52	QJ 209
	1,5	1,5	1,05	QJ 309
50	1,1	1	0,59	QJ 210
	2	2	1,35	QJ 310
55	1,5	1,5	0,77	QJ 211
	2	2	1,75	QJ 311
60	1,5	1,5	0,99	QJ 212
	2,1	2	2,15	QJ 312
65	1,5	1,5	1,2	QJ 213
	2,1	2	2,7	QJ 313

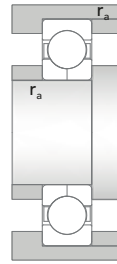
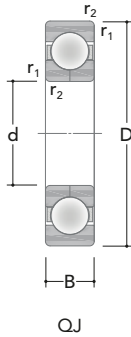

QJ

Main dimensions			Basic load ratings		Fatigue load limit C_u	Speed ratings		Designation
d	D	B	Dynamic C	Static C_0		Reference	Limiting	Standard design
[mm]			[kN]			[rpm]		
70	125	24	117,6	120,00	5,11	5800	8400	QJ 214
	150	35	202	180,00	7,35	5000	7500	QJ 314
75	130	25	125	130,00	5,52	5700	7700	QJ 215
	160	37	218,16	198,00	7,72	4800	6800	QJ 315
80	140	26	147,46	155,00	6,36	5300	7000	QJ 216
	170	39	229,68	225,00	8,54	4400	6400	QJ 316
85	150	28	152,88	172,00	6,66	4900	6900	QJ 217
	180	41	252,5	251,00	8,51	4200	6000	QJ 317
90	160	30	184,14	199,00	7,61	4500	6600	QJ 218
	190	43	282,15	303,00	10,93	4100	5800	QJ 318
95	170	32	209,88	228,00	8,35	4500	6200	QJ 219
	200	45	308,05	338,00	11,73	3800	5500	QJ 319
100	150	24	104,94	133,00	5,06	-	6300	QJ 1020
	180	34	231,28	264,00	9,46	4200	5900	QJ 220
	215	47	348,45	398,00	13,63	3600	5300	QJ 320
105	160	26	135	170,00	5,71	-	6000	QJ 1021
	190	36	237,16	265,00	9,32	-	4400	QJ 221
110	170	28	151,47	196,9	6,45	-	5700	QJ 1022
	200	38	277,2	319,0	10,99	3500	5100	QJ 222
	240	50	386,1	479,00	15,27	3300	4300	QJ 322
120	180	28	146,52	195,00	6,77	-	4400	QJ 1024
	215	40	300	364,00	11,97	3200	4600	QJ 224
	260	55	410,85	522,00	16,05	3000	4200	QJ 324

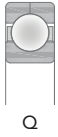

Dimensions			Mass	Designation
d	r _{1,2min}	r _{amax}		Standard design
[mm]			[kg]	
70	1,5	1,5	1,3	QJ 214
	2,1	2	3,15	QJ 314
75	1,5	1,5	1,45	QJ 215
	2,1	2	3,9	QJ 315
80	2	2	1,85	QJ 216
	2,1	2	4,6	QJ 316
85	2	2	2,25	QJ 217
	3	2,5	5,45	QJ 317
90	2	2	2,75	QJ 218
	3	2,5	6,45	QJ 318
95	2,1	2	3,35	QJ 219
	3	2,5	7,45	QJ 319
100	1,5	1,52	1,6	QJ 1020
	2,1	2	4,05	QJ 220
	3	2	9,3	QJ 320
105	2	2	2	QJ 1021
	2,1	2	4,8	QJ 221
110	2	2	2,5	QJ 1022
	2,1	2	5,6	QJ 222
	3	2,5	12,5	QJ 322
120	2	2	2,65	QJ 1024
	2,1	2	6,95	QJ 224
	3	2,5	16	QJ 324

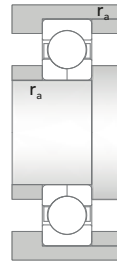
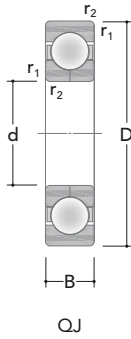

Main dimensions			Basic load ratings		Fatigue load limit C_u	Speed ratings		Designation Standard design
d	D	B	Dynamic C	Static C_0		Reference	Limiting	
[mm]			[kN]			[rpm]		
130	200	33	178,36	238,0	7,74	-	4300	QJ 1026
	230	40	303,8	397,0	12,6	3000	4400	QJ 226
	280	58	450,45	601,0	17,73	2700	3700	QJ 326
140	210	22	122,21	162,0	5,17	-	4300	305647
	210	33	191,9	264,00	8,47	-	4400	QJ 1028
	250	42	341,55	467,00	14,06	2900	4000	QJ 228
	300	62	500	686,00	19,74	2500	3300	QJ 328
150	225	35	239,58	341,7	9,34	-	4100	QJ 1030
	270	45	392	566,0	16,48	2600	3700	QJ 230
	320	65	535,3	756,0	20,95	2400	3200	QJ 330
160	240	38	270	372,4	10,5	-	3800	QJ 1032
	290	48	450	662,0	18,77	2600	3400	QJ 232
	340	68	570	866,0	23,22	2100	3100	QJ 332
170	260	42	288,86	404,00	11,77	-	3300	QJ 1034
	310	52	445,9	710,00	19,72	2400	3100	QJ 234
	360	72	661,55	1020,0	26,48	2000	2900	QJ 334
180	280	46	334,62	509,0	14,27	-	3000	QJ 1036
	320	52	475	761,0	20,69	2200	3000	QJ 236
	380	75	680	1080,0	27,49	2000	2700	QJ 336
190	290	46	344,76	500,00	13,73	1800	3100	QJ 1038
	340	55	520,2	843,0	22,22	2000	2800	QJ 238
	400	78	687,96	1148,4	2,83	1500	2500	QJ 338
200	250	24	77,71	137,0	3,9	-	3000	305419
	310	51	397,8	616,0	16,49	1800	3000	QJ 1040
	360	58	529,2	913,0	23,15	1600	2700	QJ 240
	360	70	530,4	863,00	21,55	-	2800	QJ 1240

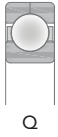

Dimensions			Mass	Designation
d	r _{1,2min}	r _{amax}		Standard design
[mm]			[kg]	
130	2	2	4,05	QJ 1026
	3	2,5	7,75	QJ 226
	4	3	19,5	QJ 326
140	1,1	1	2,6	305647
	2	2	4,3	QJ 1028
	3	2,5	9,85	QJ 228
	4	3	24	QJ 328
150	2,1	2	5,25	QJ 1030
	3	2,5	12,5	QJ 230
	4	3	29	QJ 330
160	2,1	2	6,45	QJ 1032
	3	2,5	15,5	QJ 232
	4	3	34,5	QJ 332
170	2,1	2	8,6	QJ 1034
	4	3	19,5	QJ 234
	4	3	41,5	QJ 334
180	2,1	2	11	QJ 1036
	4	3	20,5	QJ 236
	4	3	47,5	QJ 336
190	2,1	2	11,5	QJ 1038
	4	3	23,5	QJ 238
	5	4	49	QJ 338
200	0,5	0,5	2,5	305419
	2,1	2	15	QJ 1040
	4	3	28,5	QJ 240
	4	3	32,5	QJ 1240

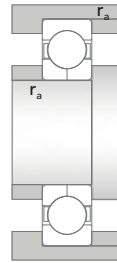
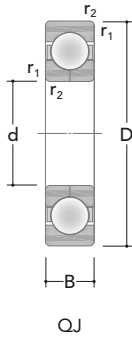

Main dimensions			Basic load ratings		Fatigue load limit C_u	Speed ratings		Designation
d	D	B	Dynamic C	Static C_0		Reference	Limiting	
[mm]			[kN]			[rpm]		
220	270	24	111	192,0	5,17	-	3000	305976
	340	56	450,84	736,0	18,65	1700	2800	QJ 1044
	400	65	547,47	979,0	23,58	-	2300	QJ 244
	400	78	580,16	1000,0	24,02	-	2400	QJ 1244
	460	88	780	1390,0	31,77	-	2200	QJ 344
240	360	56	449	772,00	19,1	1600	2200	QJ 1048
	440	72	663	1180,0	27,04	-	2100	QJ 248
	440	85	656,37	1200,0	27,54	-	2200	QJ 1248
260	360	46	382,2	709,0	16,98	-	2200	QJ 1952
	400	65	540	996,0	23,11	-	2100	QJ 1052
	480	80	728	1420,0	31,78	-	2100	QJ 252
	480	90	748,41	1450,00	31,78	-	2000	QJ 1252
280	420	65	573,3	1151,4	23,26	1500	2100	QJ 1056
	500	90	728	1450,0	31,28	-	1800	QJ 1256
300	460	74	709,02	1415,7	28,83	1500	2000	QJ 1060
	540	98	848,64	1730,0	35,88	-	1800	QJ 1260
320	480	74	722,15	1545,30	29,07	1300	1800	QJ 1064
	580	105	975,12	2100,80	40,5	-	1500	QJ 1264
335	450	56	566,28	1210,0	25,79	-	1700	309941
340	520	82	787,8	1670,0	34,87	1100	1600	QJ 1068
	620	118	1060	2410,0	46,72	-	1500	QJ 1268
360	540	82	869,04	1911	35,05	900	1500	QJ 1072
	650	122	1121,1	2560,0	48,25	-	1400	QJ 1272
380	560	82	901,68	2060,4	36,67	900	1400	QJ 1076

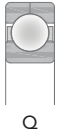

Dimensions			Mass	Designation
d	r _{1,2min}	r _{amax}		Standard design
[mm]			[kg]	
220	1,5	1	3	305976
	3	2,5	19,5	QJ 1044
	4	3	39,5	QJ 244
	4	3	45,5	QJ 1244
	5	4	78	QJ 344
240	3	2,5	21	QJ 1048
	4	3	53,2	QJ 248
	4	3	61	QJ 1248
260	2,1	2	15	QJ 1952
	4	3	31,5	QJ 1052
	5	4	68	QJ 252
	5	4	78,5	QJ 1252
280	4	3	33,5	QJ 1056
	5	4	82	QJ 1256
300	4	3	47,5	QJ 1060
	5	4	105	QJ 1260
320	5	3	50	QJ 1064
	5	4	130	QJ 1264
335	3	2,5	27	309941
340	5	4	67,5	QJ 1068
	6	5	165	QJ 1268
360	5	4	70,5	QJ 1072
	6	5	190	QJ 1272
380	5	4	72,5	QJ 1076

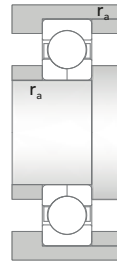
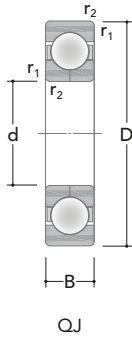

Main dimensions			Basic load ratings		Fatigue load limit C_u	Speed ratings		Designation Standard design
d	D	B	Dynamic C	Static C_0		Reference	Limiting	
[mm]			[kN]			[rpm]		
380	680	132	1170	2820,0	51,45	-	1300	QJ 1276
(cont.)								
400	600	90	913,04	2120,0	39,75	900	1400	QJ 1080
	720	140	1313	3190	57,42	-	1200	QJ 1280
420	560	65	624,26	1632,0	29,74	-	1500	QJ 1984
	620	90	923	2250,0	41,94	800	1400	QJ 1084
	760	150	1415,7	3675,0	62,63	-	1200	QJ 1284
440	600	74	753,39	1870,0	34,94	-	1400	QJ 1988
	650	94	985,05	2470,0	44,95	700	1300	QJ 1088
	790	155	1372	3690	62,98	-	1100	QJ 1288
460	680	100	1029,6	2600,0	45,62	700	1200	QJ 1092
	830	165	1560,6	4240,0	69,34	-	1000	QJ 1292
480	700	100	1081,2	2800,0	46,97	700	1200	QJ 1096
	870	170	1713,6	4680,0	75,37	-	1000	QJ 1296

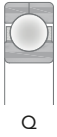

Dimensions			Mass	Designation
d	r _{1,2min}	r _{amax}		Standard design
[mm]			[kg]	
380	6	5	220	QJ 1276
(cont.)				
400	5	4	95	QJ 1080
	6	5	265	QJ 1280
420	4	3	51	QJ 1984
	5	4	99,5	QJ 1084
	7,5	6	315	QJ 1284
440	4	3	65	QJ 1988
	6	5	115	QJ 1088
	7,5	6	350	QJ 1288
460	6	5	130	QJ 1092
	7,5	6	415	QJ 1292
480	6	5	135	QJ 1096
	7,5	6	470	QJ 1296



Cylindrical roller bearings

Cylindrical roller bearings	126
Single row cylindrical roller bearings	126
Radial internal clearance	126
Misalignment.....	129
Axial displacement	129
Minimum load.....	129
Axial load carrying capacities	129
Designs and variants	131
Type NU.....	131
Type NUB	131
Type N	131
Type NUP	131
Type NJ	131
Type NJGL.....	132
Type NF	132
Type NJF	132
Split type SCRB FIXED/LOOSE	132
Prefixes.....	133
Suffixes.....	133
Product tables.....	136
Single row full complement cylindrical roller bearings	170
Radial internal clearance	170
Misalignment.....	170
Minimum load	170
Axial load carrying capacities	171
Type NJG (SL19)	172
Type NCF (SL18)	172
Suffixes.....	173
Product tables.....	174
Double row cylindrical roller bearings	190
Internal clearance.....	190
Axial displacement	190
Misalignment.....	190
Minimum load	190
Designs and variants	191
Type NNU.....	191
Type NNUP	191

Type NNUB	191
Type NN	191
Split type 2ROW SCRB.....	192
Prefixes.....	193
Suffixes.....	193
Product tables.....	194
Double row full complement cylindrical roller bearings	214
Internal clearance.....	214
Axial displacement	214
Misalignment.....	214
Minimum load	214
Designs and variants	215
Type NNC (SL01)	215
Type NNF (SL04)	215
Type NNCL (SL02).....	215
Type NNCF	215
Suffixes.....	216
Product tables.....	218
Multi row cylindrical roller bearings.....	240
Internal clearance.....	240
Minimum load.....	240
Bearing fittings.....	240
Designs and variants	242
Type AF2D/A2D.....	242
Type F2CII/EVO	242
Type Q2AC.....	242
Type GB2DX.....	242
Type D2CII.....	243
Special designs and variants.....	243
Type AF2D/A2D K/K30.....	243
Prefixes.....	244
Suffixes.....	244
Product tables.....	246

RKB
BEARING INDUSTRIES
SWITZERLAND

Cylindrical roller bearings

The cylindrical roller bearings (CRBs) manufactured by RKB are produced in many designs, dimensions and series, to withstand heavy radial loads and medium speeds, covering most of the requirements in a variety of standard and special industrial applications. All CRBs manufactured by RKB offers the highest load rating capacities, improved internal geometry, high quality materials and special heat treatments for superior performance. RKB CRBs are available with cylindrical or tapered bore in single, double or multi row configuration. Depending on application requirements, RKB Bainite Hardening Treatment (HB) and High Temperature Dimensional Stabilization (S) can be applied on bearing rings and rollers. The bearing dimensional and running accuracy conforms to ISO/ABMA/GOST specifications.



Single row cylindrical roller bearings

RKB offers a wide range of single row cylindrical roller bearing designs in normal or reinforced execution with increased performance in critical applications. Roller and raceway profiles are designed to attain optimized stress distribution while minimizing the edge effect, especially under critical conditions. The portfolio of RKB single row CRBs is finally enhanced by the high-capacity full complement bearings (cageless), which reach higher load carrying capacities within the same boundary dimensions.

Radial internal clearance

Single row cylindrical roller bearings are produced as standard with Normal radial clearance CN, but they are available with C2, C3, C4 and C5 radial clearance, in accordance with the ISO 5753:2009.

Bearings with special radial clearance different than ISO 5753:2009 can be manufactured on request. The radial internal clearance of cylindrical roller bearings with cylindrical bore can be found in **Tab. 1 page 127**. The radial internal clearance of cylindrical roller bearings with tapered bore can be found in **Tab. 2 page 128** and they are valid only for bearing unmounted and unloaded.

d [mm]		Radial internal clearance [μm]									
		C2		CN		C3		C4		C5	
over	incl.	min.	max.	min.	max.	min.	max.	min.	max.	min.	max.
-	10	0	25	20	45	35	60	50	75	-	-
10	24	0	25	20	45	35	60	50	75	65	90
24	30	0	25	20	45	35	60	50	75	70	95
30	40	5	30	25	50	45	70	60	85	80	105
40	50	5	35	30	60	50	80	70	100	95	125
50	65	10	40	40	70	60	90	80	110	110	140
65	80	10	45	40	75	65	100	90	125	130	165
80	100	15	50	50	85	75	110	105	140	155	190
100	120	15	55	50	90	85	125	125	165	180	220
120	140	15	60	60	105	100	145	145	190	200	245
140	160	20	70	70	120	115	165	165	215	225	275
160	180	25	75	75	125	120	170	170	220	250	300
180	200	35	90	90	145	140	195	195	250	275	330
200	225	45	105	105	165	160	220	220	280	305	365
225	250	45	110	110	175	170	235	235	300	330	395
250	280	55	125	125	195	190	260	260	330	370	440
280	315	55	130	130	205	200	275	275	350	410	485
315	355	65	145	145	225	225	305	305	385	455	535
355	400	100	190	190	280	280	370	370	460	510	600
400	450	110	210	210	310	310	410	410	510	565	665
450	500	110	220	220	330	330	440	440	550	625	735
500	560	120	240	240	360	360	480	480	600	-	-
560	630	140	260	260	380	380	500	500	620	-	-
630	710	145	285	285	425	425	565	565	705	-	-
710	800	150	310	310	470	470	630	630	790	-	-
800	900	180	350	350	520	520	690	690	860	-	-
900	1000	200	390	390	580	580	770	770	960	-	-
1000	1120	220	430	430	640	640	850	850	1060	-	-
1120	1250	230	470	470	710	710	950	950	1190	-	-
1250	1400	270	530	530	790	790	1050	1050	1310	-	-
1400	1600	330	610	610	890	890	1170	1170	1450	-	-
1600	1800	380	700	700	1020	1020	1340	1340	1660	-	-
1800	2000	400	760	760	1120	1120	1480	1480	1840	-	-

Tab. 1 - Radial internal clearance of cylindrical roller bearings with cylindrical bore

d [mm]		Radial internal clearance [μm]							
		C2		CN		C3		C4	
over	incl.	min.	max.	min.	max.	min.	max.	min.	max.
–	10	15	40	30	55	40	65	50	75
10	24	15	40	30	55	40	65	50	75
24	30	20	45	35	60	45	70	55	80
30	40	20	45	40	65	55	80	70	95
40	50	25	55	45	75	60	90	75	105
50	65	30	60	50	80	70	100	90	120
65	80	35	70	60	95	85	120	110	145
80	100	40	75	70	105	95	130	120	155
100	120	50	90	90	130	115	155	140	180
120	140	55	100	100	145	130	175	160	205
140	160	60	110	110	160	145	195	180	230
160	180	75	125	125	175	160	210	195	245
180	200	85	140	140	195	180	235	220	275
200	225	95	155	155	215	200	260	245	305
225	250	105	170	170	235	220	285	270	335
250	280	115	185	185	255	240	310	295	365
280	315	130	205	205	280	265	340	325	400
315	355	145	225	225	305	290	370	355	435
355	400	165	255	255	345	330	420	405	495
400	450	185	285	285	385	370	470	455	555
450	500	205	315	315	425	410	520	505	615
500	560	230	350	350	470	455	575	560	680
560	630	260	380	380	500	500	620	620	740
630	710	295	435	435	575	565	705	695	835
710	800	325	485	485	645	630	790	775	935
800	900	370	540	540	710	700	870	860	1 030
900	1 000	410	600	600	790	780	970	960	1 150
1 000	1 120	455	665	665	875	865	1 075	1 065	1 275
1 120	1 250	490	730	730	970	960	1 200	1 200	1 440
1 250	1 400	550	810	810	1 070	1 070	1 330	1 330	1 590
1 400	1 600	640	920	920	1 200	1 200	1 480	1 480	1 760
1 600	1 800	700	1 020	1 020	1 340	1 340	1 660	1 660	1 980
1 800	2 000	760	1 120	1 120	1 480	1 480	1 840	1 840	2 200

Tab. 2 - Radial internal clearance of cylindrical roller bearings with tapered bore

Misalignment

The permissible misalignment between the shaft and the seat of a single row cylindrical roller bearing is restricted to a few minutes of arc. In particular we can theoretically estimate:

- 4 minutes of arc for bearings in the 10, 12, 2, 3 and 4 series;
- 3 minutes of arc for bearings in the 18, 19, 20, 22 and 23 series.

These values are applied for the non-locating bearings, if the shaft and housing axes remain unchanged. Larger values of misalignment may be used, but with negative consequences regarding the bearing life. When the bearings are used in locating position, the permissible misalignments have to be reduced since an axial load in the bearing rib may generate heavy wear or a crack of the rib.

Bearing type NUP and NJ with HJ angle ring have two ribs on the inner ring and two ribs on the outer ring with a relatively small axial displacement. For this reason it is not possible to apply the permissible misalignment values given in the guideline since an axial stress may be generated, causing a premature failure of the bearing. For additional information, please consult the RKB application engineering service.

Axial displacement

RKB cylindrical roller bearing NU, N and NJ design allow axial displacement of the shaft with respect to the housing in order to withstand thermal gradient of temperature that may lead to axial movement.

Minimum load

A minimum radial load is requested for single row cylindrical roller bearings to allow the correct functioning, especially in critical working conditions like: high speed, high acceleration and sudden changes of rotating

direction. In these operating conditions, a skidding between rollers and raceways can be generated by the inertial forces, influencing negatively the bearing life. Assuming a continuous operation, the minimum radial load can be estimated using the following formula:

$$F_{rm} > \frac{C_{0r}}{50}$$

Where:

- F_{rm} minimum radial load, [kN];
- C_{0r} static load rating, [kN].

Usually, the minimum radial load is reached or surpassed by the weight of the components supported by the bearing together with the loads acting on it, otherwise supplementary radial load must be applied. In application where a starting up at a low temperature is planned or a lubricant with high viscosity is used, a greater minimum radial load is required.

Axial load carrying capacities

RKB cylindrical roller bearings featuring ribs on both inner and outer rings can withstand thrust load according to dissipation and lubrication among roller heads and rib contact surfaces.

In order to withstand continuous axial loads the bearings have to be subject to a simultaneous radial force, while bearing ribs have to be supported across their full height.

The maximum axial load has to be in compliance with the following disequations:

$$F_a \leq 0,4 F_r$$

$$F_a \leq \frac{K_1 \cdot K_2 \cdot d_m^{1,5} \cdot n^{-0,6}}{1000}$$

$$F_a \leq \frac{K_2 \cdot d_m^2}{1000}$$

Where:

- F_a maximum axial load, [kN];
- K_1 experimental factor connected with lubrication system, [kN] see following **Tab. 3 page 130**;
- K_2 experimental factor connected with bearing series see following **Tab. 4 page 130**;
- n operating speed [rpm];
- d_m mean bearing diameter [mm];

Lubrication system	Factor K_1
Minimal heat dissipation	122,7
Average heat dissipation, oil splash system	182,7
Good heat dissipation, recirculating oil system	213,4
Very good heat dissipation, recirculating oil system with external cooler	285,3

Tab. 3 - Experimental Factor K_1

Series	Factor K_2
NJ2, NJ22, NUP2, NUP22	1,11
NJ3, NJ23, NUP3, NUP23	1,47
NJ4	1,52

Tab. 4 - Experimental Factor K_2

For additional information regarding the above limits please consult the RKB application engineering services.

Designs and variants

Type NU

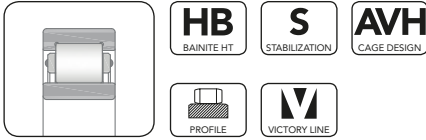

- Outer ring with two integral side ribs
- Ribless inner ring
- Two-piece machined brass cage guided on rollers (M) or outer ring (MA)
- Available with riveted or AVH cage also with lubrication grooves
- Optimized raceway geometry and roller profile
- To be used in non-locating position

Type NUB

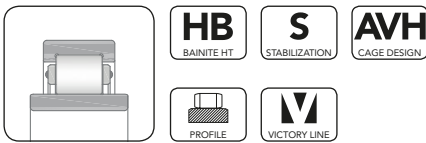

- Outer ring with two integral side ribs
- Wider ribless inner ring
- Two-piece machined brass cage guided on rollers (M) or outer ring (MA)
- Available with riveted or AVH cage also with lubrication grooves
- Optimized raceway geometry and roller profile
- To be used in non-locating position

Type N



- Ribless outer ring

- Inner ring with two integral side ribs
- Two-piece machined brass cage guided on rollers (M) or inner ring (MB)
- Lubrication grooves in side faces of inner ring
- Available with riveted or AVH cage also with lubrication grooves
- Optimized raceway geometry and roller profile
- To be used in non-locating position

Type NUP

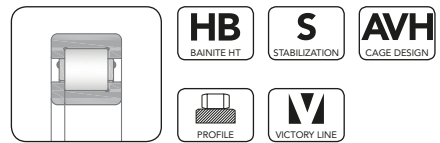

- Outer ring with two integral side ribs
- Inner ring with one integral side rib and one loose rib
- Two-piece machined brass cage guided on rollers (M) or outer ring (MA)
- Available with riveted or AVH cage also with lubrication grooves
- Optimized raceway geometry and roller profile
- Can be used in locating position

Type NJ

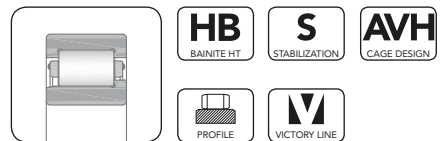

- Outer ring with two integral side ribs
- Inner ring with one integral side rib
- Two-piece machined brass cage guided on rollers (M) or outer ring (MA)
- Available with riveted or AVH cage also with lubrication grooves
- Optimized raceway geometry and roller profile
- Can be used in one direction locating position

Type NJGL

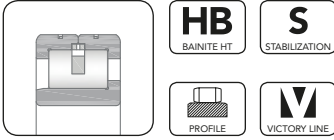

- Outer ring circumferentially split
- Inner ring with one integral side rib
- Lamellar brass cage design
- Designed to maintain high carrying capacities without compromising the rotational speed capability
- Optimized raceway geometry and roller profile

- Available with riveted or AVH cage also with lubrication grooves
- Optimized raceway geometry and roller profile
- Can be used in one direction locating position

Split type SCRIB FIXED/LOOSE

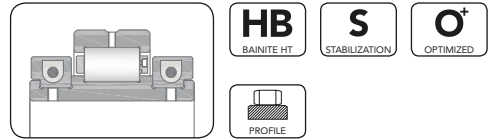

- Design used for medium and large size bearings
- Wider inner ring with integral side ribs
- Two-piece window type
- Engineered for hard-to-reach positions (e.g. universal joint drive shaft supporting)
- Design for easy mounting, dismounting and maintenance to reduced machine downtime
- Available in locating and non-locating configuration
- Available in taylor-made dimension
- Optimized raceway geometry and roller profile

Type NF

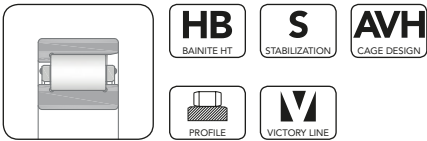

- Outer ring with one integral side rib
- Inner ring with two integral side ribs
- Two-piece machined brass cage guided on rollers (M) or outer ring (MA)
- Available with riveted or AVH cage also with lubrication grooves
- Optimized raceway geometry and roller profile
- Can be used in one direction locating position

- Design used for medium and large size bearings
- Wider inner ring with integral side ribs
- Two-piece window type
- Engineered for hard-to-reach positions (e.g. universal joint drive shaft supporting)
- Design for easy mounting, dismounting and maintenance to reduced machine downtime
- Available in locating and non-locating configuration
- Available in taylor-made dimension
- Optimized raceway geometry and roller profile

Type NJF



- Outer ring with one integral side rib
- Inner ring with one integral side rib
- Two-piece machined brass cage guided on rollers (M) or outer ring (MA)

Prefixes

L	In a separable bearing: separate inner ring
R	In a separable bearing: outer ring with roller and cage assembly
SCRB	Out of standard split cylindrical roller bearing followed by drawing number

Suffixes

Internal Design

E	Optimized internal design with reinforced execution
EC	Optimized internal design for increased load ratings
SP	Special or non-standard bearing
ZB	Optimized roller profile for improved load distribution. It is not necessarily stated in the bearing code

Suffixes

Cage

MP1	One-piece solid HBSC1 brass cage guided on rollers
MP1A	One-piece solid HBSC1 brass cage guided on outer ring
MP1B	One-piece solid HBSC1 brass cage guided on inner ring
M	Machined brass cage guided on rollers
MA	Machined brass cage guided on outer ring
MAS	Machined brass cage guided on outer ring with lubrication grooves in the guiding surface
MB	Machined brass cage guided on inner ring
MBS	Machined brass cage guided on inner ring with lubrication grooves in the guiding surface
J	Pressed steel cage
TN or ATN	Molded polyamide cage (PA66) guided on rollers
TN9	Molded glass fiber-reinforced polyamide cage (PA66-GF25) guided on rollers
AVH	Machined brass cage with round or square integral rivets guided on outer ring (MA), inner ring (MB) or rollers (M)

Suffixes

Accuracy, clearance, running

C2	Radial internal clearance less than CN
CN	Standard radial internal clearance
C3	Radial internal clearance greater than Normal (CN)
C4	Radial internal clearance greater than C3
C5	Radial internal clearance greater than C4
CS	Special radial internal clearance
P6	Dimensional and running accuracy as per ISO tolerances Class 6

Suffixes	External design
K	Tapered bore, taper 1:12
K30	Tapered bore, taper 1:30
N	Snap ring groove in outer ring
N1	One locating slot in outer ring
N2	Two locating slots in outer ring



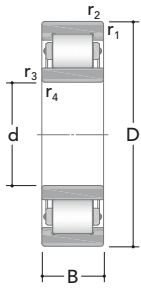

NU

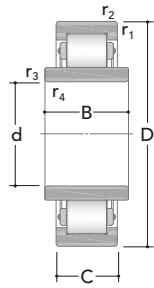

NUB

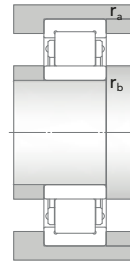

Main dimensions				Basic load ratings		Fatigue load limit	Speed ratings		Designation
d	D	B	C	Dynamic C	Static C ₀	C _u	Reference	Limiting	Standard design
[mm]				[kN]			[rpm]		
15	35	11	-	12,7	10,1	1,21	21400	23200	NU 202
17	40	12	-	17	14,1	1,71	18400	19700	NU 203
	40	16	-	23,5	21,4	2,63	18400	19600	NU 2203
	47	14	-	24,3	20,2	2,53	14600	17200	NU 303
20	47	14	-	25,2	21,9	2,74	15600	16400	NU 204
	47	18	-	29,6	27	3,39	15500	16600	NU 2204
	52	15	-	35,4	25,9	3,24	14500	15900	NU 304
	52	21	-	47	37,9	4,8	14500	15400	NU 2304
25	47	12	-	14,3	13,1	1,4	16300	15500	NU 1005
	52	15	-	28	26,7	3,31	13400	13800	NU 205
	52	18	-	38,6	33,7	4,21	13600	14300	NU 2205
	62	17	-	46,6	36,4	4,54	11500	13100	NU 305
	62	24	-	63,8	54,3	6,86	11700	13200	NU 2305
30	55	13	-	17,7	17,3	1,86	13600	13100	NU 1006
	62	16	-	44,5	36,1	4,5	12100	12400	NU 206
	62	20	-	55	48,2	6	11700	12400	NU 2206
	72	19	-	59,3	47,4	6,1	10100	10300	NU 306
	72	27	-	83,9	75	9,65	10300	10600	NU 2306
	90	23	-	60,5	52,5	6,7	8600	9400	NU 406
35	62	14	-	35,5	37,4	4,48	11600	11200	NU 1007
	72	17	-	56	47,7	6,1	9900	10300	NU 207
	72	23	-	69,4	62,2	8,05	10000	10700	NU 2207
	80	21	-	74,2	62	8,02	9000	9500	NU 307
	80	31	-	105	96,8	12,5	9100	9500	NU 2307
	100	25	-	77	68,4	9	7700	8300	NU 407
40	68	15	-	24,7	25,9	3	11700	15500	NU 1008
	80	18	-	62,6	52,9	6,7	9200	9500	NU 208

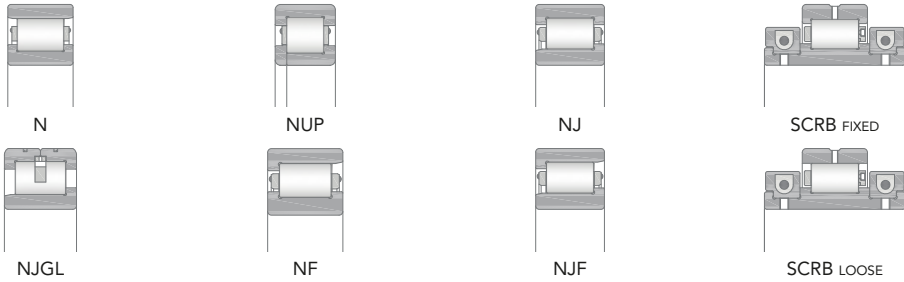

Dimensions					Mass	Designation		
d	r _{1,2min}	r _{3,4min}	r _{amax}	r _{bmax}		Standard design	Alternative design	Angle ring
[mm]					[kg]			
15	0,6	0,3	0,6	0,3	0,047	NU 202	N, NJ, NUP	-
17	0,6	0,3	0,6	0,3	0,068	NU 203	N, NJ, NUP	-
	0,6	0,3	0,6	0,3	0,087	NU 2203	N, NJ, NUP	-
	1	0,6	1	0,6	0,12	NU 303	N, NJ, NUP	-
20	1	0,6	1	0,6	0,11	NU 204	N, NJ, NUP	-
	1	0,6	1	0,6	0,14	NU 2204	N, NJ, NUP	-
	1,1	0,6	1	0,6	0,15	NU 304	N, NJ, NUP	HJ 304
	1,1	0,6	1	0,6	0,21	NU 2304	N, NJ, NUP	-
25	0,6	0,3	0,6	0,3	0,083	NU 1005	N, NJ, NUP	-
	1	0,6	1	0,6	0,13	NU 205	N, NJ, NUP	HJ 205
	1	0,6	1	0,6	0,16	NU 2205	N, NJ, NUP	HJ 2205
	1,1	1,1	1	1	0,23	NU 305	N, NJ, NUP	HJ 305
	1,1	1,1	1	1	0,34	NU 2305	N, NJ, NUP	HJ 2305
30	1	0,6	1	0,6	0,12	NU 1006	N, NJ, NUP	-
	1	0,6	1	0,6	0,2	NU 206	N, NJ, NUP	HJ 206
	1	0,6	1	0,6	0,26	NU 2206	N, NJ, NUP	-
	1,1	1,1	1	1	0,36	NU 306	N, NJ, NUP	HJ 306
	1,1	1,1	1	1	0,53	NU 2306	N, NJ, NUP	-
	1,5	1,5	1,5	1,5	0,75	NU 406	N, NJ, NUP	HJ 406
35	1	0,6	1	0,6	0,16	NU 1007	N, NJ, NUP	-
	1,1	0,6	1	0,6	0,29	NU 207	N, NJ, NUP	HJ 207
	1,1	0,6	1	0,6	0,4	NU 2207	N, NJ, NUP	-
	1,5	1,1	1,5	1	0,47	NU 307	N, NJ, NUP	HJ 307
	1,5	1,1	1,5	1	0,72	NU 2307	N, NJ, NUP	-
	1,5	1,5	1,5	1,5	1	NU 407	N, NJ, NUP	-
40	1	0,6	1	0,6	0,23	NU 1008	N, NJ, NUP	-
	1,1	1,1	1	1	0,37	NU 208	N, NJ, NUP	HJ 208

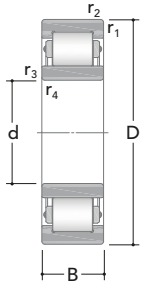

NU

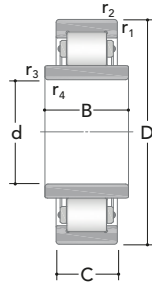

NUB

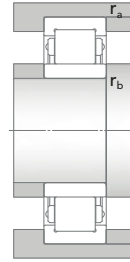

Main dimensions				Basic load ratings		Fatigue load limit	Speed ratings		Designation
d	D	B	C	Dynamic C	Static C ₀	C _u	Reference	Limiting	Standard design
[mm]				[kN]			[rpm]		
40 (cont.)	80	23	-	81,4	74,7	9,61	9000	9600	NU 2208
	90	23	-	92,8	77,7	10,2	7700	8500	NU 308
	90	33	-	128	118	15	7700	8300	NU 2308
	110	27	-	96,1	89,6	11,5	6800	7300	NU 408
45	75	16	-	44,2	51,6	6,3	9800	9600	NU 1009
	85	19	-	69,1	62,8	8	8000	8200	NU 209
	85	23	-	86	80,3	10,4	8400	8200	NU 2209
	100	25	-	111	98,4	12,7	7100	7400	NU 309
	100	36	-	160	152	20	7200	7300	NU 2309
	120	29	-	104	101	13,3	6200	6500	NU 409
50	80	16	-	46,4	55,2	6,6	8800	8500	NU 1010
	90	20	-	74	69,1	8,7	7700	7800	NU 210
	90	23	-	90	87,7	11,4	7600	7700	NU 2210
	110	27	-	125	111	15	6500	6900	NU 310
	110	40	-	188	184	24,2	6400	7000	NU 2310
	130	31	-	130	125	16,3	5800	6200	NU 410
55	90	18	-	57,1	69,2	8,3	7600	7600	NU 1011
	100	21	-	97	94,5	12,1	6800	7100	NU 211
	100	25	-	114	117	15,2	6800	6900	NU 2211
	120	29	-	153	143	18,6	5800	6000	NU 311
	120	43	-	230	228	30	5700	6200	NU 2311
	140	33	-	142	139	18,5	5300	5600	NU 411
60	95	18	-	37,5	43,5	5,2	7700	11600	NU 1012
	110	22	-	106	101	13,3	6200	6600	NU 212
	110	28	-	148	152	20	6400	6700	NU 2212
	130	31	-	175	160	21,2	5400	6000	NU 312
	130	46	-	257	261	34	5400	6000	NU 2312
	150	35	-	170	170	22	4800	5200	NU 412

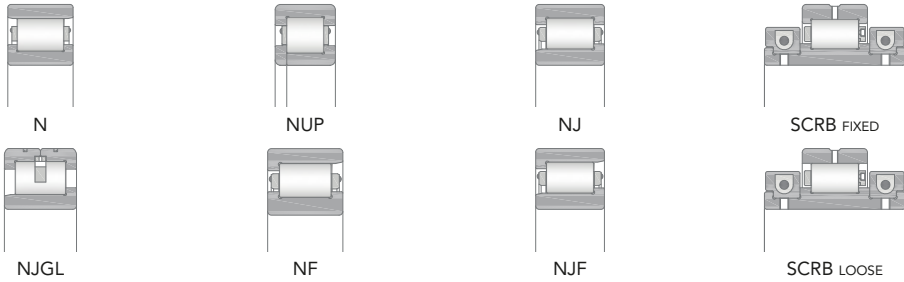

Dimensions					Mass	Designation		
d	r _{1,2min}	r _{3,4min}	r _{amax}	r _{bmax}		Standard design	Alternative design	Angle ring
[mm]					[kg]			
40	1,1	1,1	1	1	0,49	NU 2208	N, NJ, NUP	HJ 2208
(cont.)	1,5	1,5	1,5	1,5	0,65	NU 308	N, NJ, NUP	HJ 308
	1,5	1,5	1,5	1,5	0,94	NU 2308	N, NJ, NUP	-
	2	2	2	2	1,3	NU 408	N, NJ, NUP	-
45	1	0,6	1	0,6	0,25	NU 1009	N, NJ, NUP	-
	1,1	1,1	1	1	0,43	NU 209	N, NJ, NUP	HJ 209
	1,1	1,1	1	1	0,52	NU 2209	N, NJ, NUP	-
	1,5	1,5	1,5	1,5	0,9	NU 309	N, NJ, NUP	HJ 309
	1,5	1,5	1,5	1,5	1,3	NU 2309	N, NJ, NUP	-
	2	2	2	2	1,65	NU 409	N, NJ, NUP	HJ 409
50	1	0,6	1	0,6	0,27	NU 1010	N, NJ, NUP	-
	1,1	1,1	1	1	0,48	NU 210	N, NJ, NUP	HJ 210
	1,1	1,1	1	1	0,56	NU 2210	N, NJ, NUP	-
	2	2	2	2	1,15	NU 310	N, NJ, NUP	HJ 310
	2	2	2	2	1,75	NU 2310	N, NJ, NUP	-
	2,1	2,1	2	2	2	NU 410	N, NJ, NUP	HJ 410
55	1,1	1	1	1	0,39	NU 1011	N, NJ, NUP	-
	1,5	1,1	1,5	1	0,66	NU 211	N, NJ, NUP	HJ 211
	1,5	1,1	1,5	1	0,79	NU 2211	N, NJ, NUP	HJ 2211
	2	2	2	2	1,45	NU 311	N, NJ, NUP	HJ 311
	2	2	2	2	2,2	NU 2311	N, NJ, NUP	HJ 2311
	2,1	2,1	2	2	2,5	NU 411	N, NJ, NUP	-
60	1,1	1	1	1	0,5	NU 1012	N, NJ, NUP	-
	1,5	1,5	1,5	1,5	0,8	NU 212	N, NJ, NUP	HJ 212
	1,5	1,5	1,5	1,5	1,05	NU 2212	N, NJ, NUP	HJ 212
	2,1	2,1	2	2	1,75	NU 312	N, NJ, NUP	HJ 312
	2,1	2,1	2	2	2,75	NU 2312	N, NJ, NUP	HJ 2312
	2,1	2,1	2	2	3	NU 412	N, NJ, NUP	-

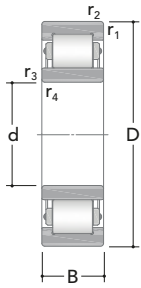

NU

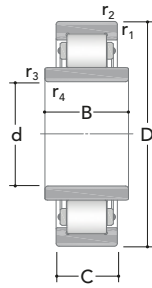

NUB

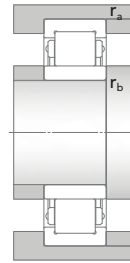

Main dimensions				Basic load ratings		Fatigue load limit	Speed ratings		Designation
d	D	B	C	Dynamic C	Static C ₀	C _u	Reference	Limiting	Standard design
[mm]				[kN]			[rpm]		
65	100	18	-	63	81	9,7	6800	6400	NU 1013
	120	23	-	121	117	15,5	5600	6000	NU 213
	120	31	-	170	180	24	5600	6000	NU 2213
	140	33	-	212	193	25,1	5100	5300	NU 313
	140	48	-	287	289	38	5100	5300	NU 2313
	160	37	-	181	189	24	4600	4800	NU 413
70	110	20	-	77,3	91,9	12	6300	6200	NU 1014
	125	24	-	137	135	18	5400	5600	NU 214
	125	31	-	182	191	25,2	5300	5600	NU 2214
	150	35	-	235	224	28	4600	4900	NU 314
	150	51	-	315	323	41,2	4600	4900	NU 2314
	180	42	-	231	237	30	4200	4500	NU 414
75	115	20	-	58	70,1	8,4	6500	8600	NU 1015
	130	25	-	149	153	20	5000	5300	NU 215
	130	31	-	188	204	26	5100	5300	NU 2215
	160	37	-	277	264	33,4	4300	4700	NU 315
	160	55	-	380	394	49	4300	4700	NU 2315
	190	45	-	265	275	33	3800	4200	NU 415
80	125	22	-	64,5	77,9	9,8	5800	5600	NU 1016
	140	26	-	159	163	20,8	4700	4900	NU 216
	140	33	-	214	243	31	4700	4900	NU 2216
	170	39	-	294	287	36	4200	4300	NU 316
	170	58	-	413	439	55	4100	4300	NU 2316
	200	48	-	303	317	39	3600	4000	NU 416
85	130	22	-	68,1	84,8	10,6	5700	7800	NU 1017
	150	28	-	187	197	25	4500	4700	NU 217
	150	36	-	250	279	34,4	4400	4500	NU 2217
	180	41	-	339	329	40,8	3800	4200	NU 317
	180	60	-	449	483	59	3900	4300	NU 2317

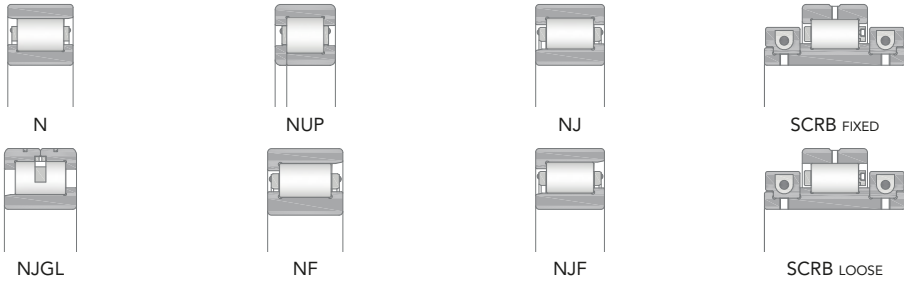

Dimensions					Mass	Designation		
d	r _{1,2min}	r _{3,4min}	r _{amax}	r _{bmax}		Standard design	Alternative design	Angle ring
[mm]					[kg]			
65	1,1	1	1	1	0,45	NU 1013	N, NJ, NUP	-
	1,5	1,5	1,5	1,5	1,05	NU 213	N, NJ, NUP	HJ 213
	1,5	1,5	1,5	1,5	1,4	NU 2213	N, NJ, NUP	HJ 2213
	2,1	2,1	2	2	2,2	NU 313	N, NJ, NUP	HJ 313
	2,1	2,1	2	2	3,2	NU 2313	N, NJ, NUP	HJ 2313
	2,1	2,1	2	2	3,55	NU 413	N, NJ, NUP	HJ 413
70	1,1	1	1	1	0,62	NU 1014	N, NJ, NUP	HJ 1014
	1,5	1,5	1,5	1,5	1,15	NU 214	N, NJ, NUP	HJ 214
	1,5	1,5	1,5	1,5	1,5	NU 2214	N, NJ, NUP	HJ 2214
	2,1	2,1	2	2	2,7	NU 314	N, NJ, NUP	HJ 314
	2,1	2,1	2	2	3,95	NU 2314	N, NJ, NUP	HJ 2314
	3	3	2,5	2,5	5,35	NU 414	N, NJ, NUP	HJ 414
75	1,1	1	1	1	0,75	NU 1015	N, NJ, NUP	-
	1,5	1,5	1,5	1,5	1,25	NU 215	N, NJ, NUP	HJ 215
	1,5	1,5	1,5	1,5	1,6	NU 2215	N, NJ, NUP	-
	2,1	2,1	2	2	3,3	NU 315	N, NJ, NUP	HJ 315
	2,1	2,1	2	2	4,8	NU 2315	N, NJ, NUP	HJ 2315
	3	3	2,5	2,5	6,2	NU 415	N, NJ, NUP	HJ 415
80	1,1	1	1	1	0,88	NU 1016	N, NJ, NUP	-
	2	2	2	2	1,55	NU 216	N, NJ, NUP	HJ 216
	2	2	2	2	2	NU 2216	N, NJ, NUP	HJ 216
	2,1	2,1	2	2	3,85	NU 316	N, NJ, NUP	HJ 316
	2,1	2,1	2	2	5,85	NU 2316	N, NJ, NUP	HJ 2316
	3	3	2,5	2,5	7,25	NU 416	N, NJ, NUP	HJ 416
85	1,1	1	1	1	1,05	NU 1017	N, NJ, NUP	-
	2	2	2	2	1,9	NU 217	N, NJ, NUP	HJ 217
	2	2	2	2	2,5	NU 2217	N, NJ, NUP	-
	3	3	2,5	2,5	4,65	NU 317	N, NJ, NUP	HJ 317
	3	3	2,5	2,5	6,85	NU 2317	N, NJ, NUP	HJ 2317

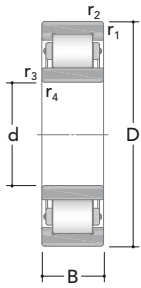

NU

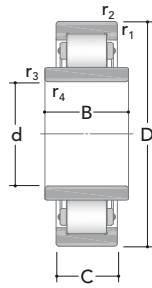

NUB

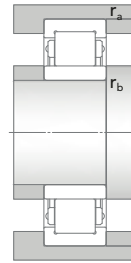

Main dimensions				Basic load ratings		Fatigue load limit	Speed ratings		Designation
d	D	B	C	Dynamic C	Static C ₀	C _u	Reference	Limiting	Standard design
[mm]				[kN]			[rpm]		
85	210	52	-	315	335	39	3400	3700	NU 417
(cont.)									
90	140	24	-	81,1	103	12,6	5400	7500	NU 1018
	160	30	-	207	218	27	4100	4400	NU 218
	160	40	-	277	313	39	4100	4400	NU 2218
	190	43	-	367	354	42	3600	3900	NU 318
	190	64	-	498	534	64,8	3700	3900	NU 2318
	225	54	-	377	408	47	3300	3500	NU 418
95	145	24	-	83,2	110	13,2	5100	7000	NU 1019
	170	32	-	252	264	32,4	3900	4200	NU 219
	170	43	-	327	371	45	3900	4200	NU 2219
	200	45	-	390	387	46,1	3400	3700	NU 319
	200	67	-	533	575	68,3	3400	3800	NU 2319
	240	55	-	410	452	52	3000	3100	NU 419
100	140	20	-	82,4	121	13,6	4900	-	NU 1920
	150	24	-	86,2	113	13,6	4800	6700	NU 1020
	150	30	-	167	239	30,4	3800	-	NU 2020
	165	52	-	307	448	55	3200	-	NU 3120
	180	34	-	289	305	36,5	3900	3900	NU 220
	180	46	-	383	441	53	3800	3900	NU 2220
	180	96	46	257	337	40,1	3400	-	NUB 313638
	180,075	60,325	-	412	581	69	3400	-	319897
	215	47	-	455	440	51	3100	3300	NU 320
	215	73	-	672	727	84	3100	3400	NU 2320
	250	58	-	463	517	58,2	2800	3100	NU 420
105	160	26	-	101,2	136	16	4600	6000	NU 1021
	190	36	-	298	313	36,3	3700	3800	NU 221
	225	49	-	501	491	56	3100	3300	NU 321
	260	60	-	508	561	63	2700	3000	NU 421

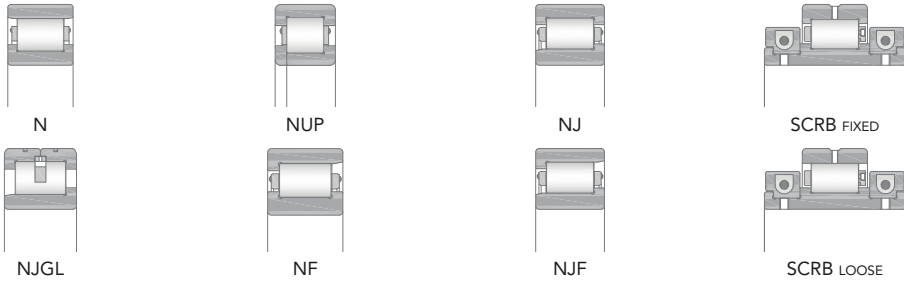

Dimensions					Mass	Designation		
d	r _{1,2min}	r _{3,4min}	r _{amax}	r _{bmax}		Standard design	Alternative design	Angle ring
[mm]					[kg]			
85	4	4	3	3	8,7	NU 417	N, NJ, NUP	HJ 417
(cont.)								
90	1,5	1,1	1,5	1	1,35	NU 1018	N, NJ, NUP	-
	2	2	2	2	2,3	NU 218	N, NJ, NUP	HJ 218
	2	2	2	2	3,15	NU 2218	N, NJ, NUP	HJ 2218
	3	3	2,5	2,5	5,25	NU 318	N, NJ, NUP	HJ 318
	3	3	2,5	2,5	8	NU 2318	N, NJ, NUP	HJ 2318
	4	4	3	3	10,5	NU 418	N, NJ, NUP	-
95	1,5	1,1	1,5	1	1,45	NU 1019	N, NJ, NUP	-
	2,1	2,1	2	2	2,85	NU 219	N, NJ, NUP	HJ 219
	2,1	2,1	2	2	3,8	NU 2219	N, NJ, NUP	-
	3	3	2,5	2,5	6,2	NU 319	N, NJ, NUP	HJ 319
	3	3	2,5	2,5	9,35	NU 2319	N, NJ, NUP	HJ 2319
	4	4	3	3	13,5	NU 419	N, NJ, NUP	-
100	1,1	1	1	1	1	NU 1920	N, NJ, NUP	-
	1,5	1,1	1,5	1	1,45	NU 1020	N, NJ, NUP	-
	1,5	1,1	1,5	1	1,8	NU 2020	N, NJ, NUP	-
	2	1,1	2	1	4,4	NU 3120	N, NJ, NUP	-
	2,1	2,1	2	2	3,4	NU 220	N, NJ, NUP	HJ 220
	2,1	2,1	2	2	4,75	NU 2220	N, NJ, NUP	HJ 2220
	2,1	2,1	2	2	6,7	NUB 313638	-	-
	2,6	2	2,5	2	7,1	319897	-	-
	3	3	2,5	2,5	7,45	NU 320	N, NJ, NUP	HJ 320
	3	3	2,5	2,5	12	NU 2320	N, NJ, NUP	HJ 2320
	4	4	3	3	15,5	NU 420	N, NJ, NUP	HJ 420
105	2	1,1	2	1	1,9	NU 1021	N, NJ, NUP	-
	2,1	2,1	2	2	3,95	NU 221	N, NJ, NUP	HJ 221
	3	3	2,5	2,5	8,55	NU 321	N, NJ, NUP	-
	4	4	3	3	17,5	NU 421	N, NJ, NUP	-

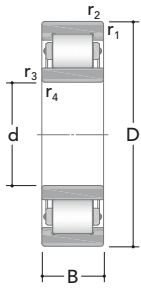

NU

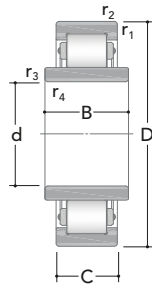

NUB

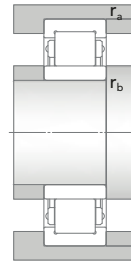

Main dimensions				Basic load ratings		Fatigue load limit	Speed ratings		Designation
d	D	B	C	Dynamic C	Static C ₀	C _u	Reference	Limiting	Standard design
[mm]				[kN]			[rpm]		
110	170	28	-	128	164	19,1	4300	6200	NU 1022
	200	38	-	334	365	42,5	3300	3500	NU 222
	200	53	-	439	520	61	3300	3500	NU 2222
	240	50	-	538	531	60	2800	3000	NU 322
	240	80	-	776	886	100	2800	2900	NU 2322
	280	65	-	525	579	63	2500	2700	NU 422
	260,324	90,075	-	750	955	105	2400	-	467062
120	165	22	-	111	170	19,3	5600	-	NU 1924
	180	28	-	134	181	20,6	3700	5500	NU 1024
	180	36	-	228	349	39,8	3000	-	NU 2024
	200	62	-	414	589	68,2	2700	-	315516
	215	40	-	395	425	48	3000	3200	NU 224
	215	58	-	519	621	71	3000	3100	NU 2224
	215	88	40	339	425	48	2800	-	NUB 322927
	240	80	-	569	764	85	2400	-	322870
	260	55	-	616	609	68,3	2600	2800	NU 324
	260	86	-	897	1035	115	2500	4300	NU 2324
310	72	-	642	733	78	2300	2400	NU 424	
129,921	228,6	79,375	-	666	1010	115	2400	-	322932
130	200	33	-	166	220	25	3500	4900	NU 1026
	200	42	-	296	439	51	2900	-	NU 2026
	200	52	-	352	586	67	2800	-	NU 3026
	230	40	-	421	450	50	2900	2900	NU 226
	230	64	-	615	724	82	2900	2900	NU 2226
	240	80	-	544	768	89	2500	-	235013
	250	75	-	529	747	83	2200	-	609341
	250	80	-	597	806	90,5	2100	-	322880
	260	86	-	715	965	106	2200	-	312733
	280	58	-	731	742	80,6	2300	2600	NU 326
	280	93	-	1058	1230	135	2300	4000	NU 2326

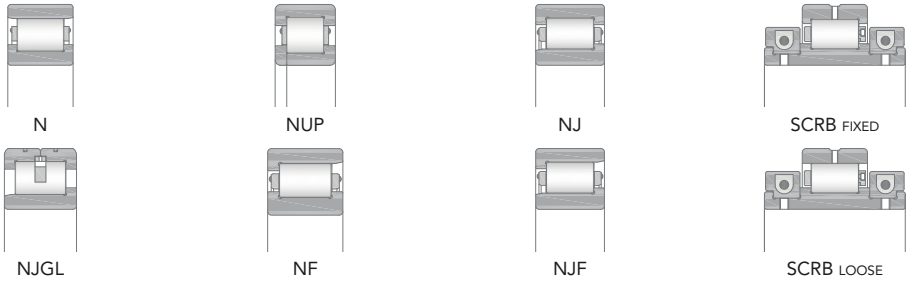

Dimensions					Mass	Designation		
d	r _{1,2min}	r _{3,4min}	r _{amax}	r _{bmax}		Standard design	Alternative design	Angle ring
[mm]					[kg]			
110	2	1,1	2	1	2,3	NU 1022	N, NJ, NUP	-
	2,1	2,1	2	2	4,7	NU 222	N, NJ, NUP	HJ 222
	2,1	2,1	2	2	6,7	NU 2222	N, NJ, NUP	-
	3	3	2,5	2,5	10,5	NU 322	N, NJ, NUP	HJ 322
	3	3	2,5	2,5	17	NU 2322	N, NJ, NUP	HJ 2322
	4	4	3	3	20,5	NU 422	N, NJ, NUP	HJ 422
	2,5	2,5	2,5	2,5	27,3	467062	-	-
120	1,1	0,6	1	0,6	1,4	NU 1924	N, NJ, NUP	-
	2	1,1	2	1	2,45	NU 1024	N, NJ, NUP	-
	2	1,1	1	1,1	3,1	NU 2024	N, NJ, NUP	-
	2	1	1	1	7,8	315516	-	-
	2,1	2,1	2	2	5,6	NU 224	N, NJ, NUP	HJ 224
	2,1	2,1	2	2	8,3	NU 2224	N, NJ, NUP	HJ 2224
	2,1	2,1	2	2	7,6	NUB 322927	-	-
	3,7	3	3,5	2,5	17,8	322870	-	-
	3	3	2,5	2,5	13	NU 324	N, NJ, NUP	HJ 324
	3	3	2,5	2,5	23,5	NU 2324	N, NJ, NUP	HJ 2324
5	5	4	4	27,5	NU 424	N, NJ, NUP	HJ 424	
129,921	5	4	2,5	3	14	322932	-	-
130	2	1,1	2	1	3,75	NU 1026	N, NJ, NUP	-
	2	1,1	1	1,1	4,6	NU 2026	N, NJ, NUP	-
	1,1	1	1	1	6,1	NU 3026	N, NJ, NUP	-
	3	3	2,5	2,5	6,45	NU 226	N, NJ, NUP	HJ 226
	3	3	2,5	2,5	10	NU 2226	N, NJ, NUP	HJ 2226
	4	3	3	2,5	16,7	235013	-	-
	3	2,5	2,5	2	15	609341	-	-
	3,7	3	3,5	2,5	17,5	322880	-	-
	7,5	3	6	2,5	21,5	312733	-	-
	4	4	3	3	16	NU 326	N, NJ, NUP	HJ 326
	4	4	3	3	30	NU 2326	N, NJ, NUP	HJ 2326

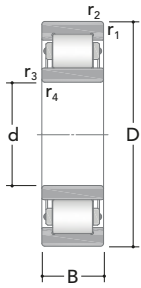

NU

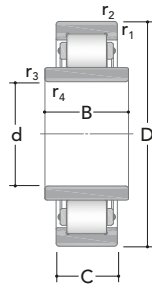

NUB

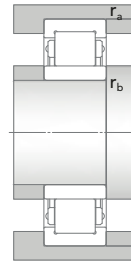

Main dimensions				Basic load ratings		Fatigue load limit	Speed ratings		Designation
d	D	B	C	Dynamic C	Static C ₀	C _u	Reference	Limiting	Standard design
[mm]				[kN]			[rpm]		
130	281	58	-	634	740	80	2100	-	319926
(cont.)	340	78	-	835	994	101	2000	-	NU 426
140	210	33	-	179	258	28	3200	4700	NU 1028
	210	42	-	311	488	55	2800	-	NU 2028
	250	42	-	456	509	57	2700	2800	NU 228
	250	68	-	652	820	92	2500	4100	NU 2228
	250	60	42	395	503	56	2400	-	NUB 322883
	270	78	-	649	864	93	2000	-	614073
	300	62	-	787	828	88	2300	2400	NU 328
	300	102	-	1214	1410	148	2200	3800	NU 2328
	300	114,3	-	1109	1550	165	2000	-	467063
	360	82	-	915	1060	106	1800	-	NU 428
149,969	320	65	-	818	1010	105	1800	-	313268
150	225	35	-	199	294	31,9	3000	4300	NU 1030
	225	45	-	346	545	60	2500	-	NU 2030
	225	56	-	411	707	78	2600	-	NU 3030
	270	45	-	505	593	63	2300	2400	NU 230
	270	73	-	734	916	98	2300	2400	NU 2230
	300	102	-	875	1230	130	1800	-	314834
	320	65	-	897	961	100	2000	3500	NU 330
	320	108	-	1364	1610	168	2000	3400	NU 2330
	380	85	-	974	1160	114	1700	-	NU 430
160	240	38	-	228	323	35,3	2700	4300	NU 1032
	240	48	-	413	663	71	2400	-	NU 2032
	240	60	-	441	780	86,5	2300	-	NU 3032
	290	48	-	582	670	71	2200	2300	NU 232
	290	80	-	921	1180	127	2100	3500	NU 2232
	290	98425	-	1013	1450	152	1900	-	320151
	300	84	-	717	1050	111	1800	-	609099

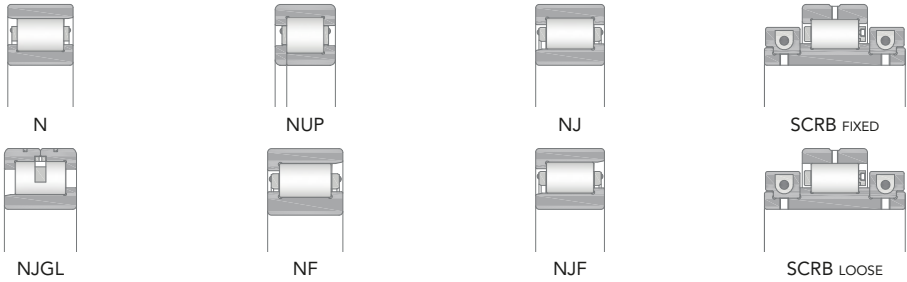

Dimensions					Mass	Designation		
d	r _{1,2min}	r _{3,4min}	r _{amax}	r _{bmax}		Standard design	Alternative design	Angle ring
[mm]					[kg]			
130	4	4	3	3	19	319926	-	-
(cont.)	5	5	4	4	36	NU 426	N, NJ, NUP	-
140	2	1,1	2	1	4	NU 1028	N, NJ, NUP	-
	2	1,1	1	1,1	4,9	NU 2028	N, NJ, NUP	-
	3	3	2,5	2,5	9,4	NU 228	N, NJ, NUP	HJ 228
	3	3	2,5	2,5	13,5	NU 2228	N, NJ, NUP	HJ 2228
	3	3	2,5	2,5	9,25	NUB 322883	-	-
	3	2,5	2,5	2,5	22	614073	-	-
	4	3	3	3	22	NU 328	N, NJ, NUP	HJ 328
	4	4	3	3	37	NU 2328	N, NJ, NUP	HJ 2328
	3	3	2,5	2,5	41,8	467063	-	-
	5	5	4	4	47	NU 428	N, NJ, NUP	-
149,969	4	4	3	3	24,5	313268	-	-
150	2,1	1,5	2	1,5	4,85	NU 1030	N, NJ, NUP	-
	2,1	1,5	1,5	1	6	NU 2030	N, NJ, NUP	-
	1,5	1,1	1	1	7,9	NU 3030	N, NJ, NUP	-
	3	3	2,5	2,5	11,5	NU 230	N, NJ, NUP	HJ 230
	3	3	2,5	2,5	18,5	NU 2230	N, NJ, NUP	HJ 2230
	4	4	3	3	35,5	314834	-	-
	4	4	3	3	28	NU 330	N, NJ, NUP	HJ 330
	4	4	3	3	45	NU 2330	N, NJ, NUP	-
	5	5	4	4	53,5	NU 430	N, NJ, NUP	-
160	2,1	1,5	2	1,5	5,95	NU 1032	N, NJ, NUP	HJ 1032
	2,1	1,5	1,5	1	7,9	NU 2032	N, NJ, NUP	-
	1,5	1	1	1	9,7	NU 3032	N, NJ, NUP	-
	3	3	2,5	2,5	14	NU 232	N, NJ, NUP	HJ 232
	3	3	2,5	2,5	24	NU 2232	N, NJ, NUP	HJ 2232
	3	3	2,5	2,5	31	320151	-	-
	7,5	4	3	3	28	609099	-	-

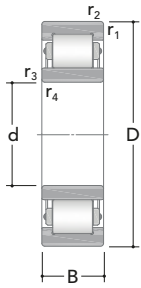

NU

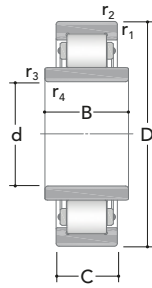

NUB

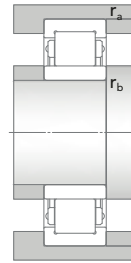

Main dimensions				Basic load ratings		Fatigue load limit	Speed ratings		Designation
d	D	B	C	Dynamic C	Static C ₀	C _u	Reference	Limiting	Standard design
[mm]				[kN]			[rpm]		
160	340	68	-	1007	1070	111	1800	3200	NU 332
(cont.)	340	114	-	1270	1850	185	1600	3200	NU 2332
165,1	279,4	61,912	-	631	892	95,6	2000	-	322832
170	230	28	-	185	287	30	2700	-	NU 1934
	260	42	-	360	395	41	2700	3700	NU 1034
	260	54	-	479	730	80,9	2200	-	NU 2034
	310	52	-	698	807	84	2000	3300	NU 234
	310	86	-	1061	1400	146	2000	3300	NU 2234
	360	72	-	950	1170	115	1600	1900	NU 334
	360	120	-	1570	2190	219	1500	3000	NU 2334
180	250	33	-	243	395	41	3600	-	NU 1936
	250	42	-	255	440	46,5	2500	-	NU 2936
	280	46	-	338	473	51	2400	3500	NU 1036
	280	60	-	625	966	103	2100	-	NU 2036
	280	74	-	699	1180	125	2000	-	NU 3036
	320	52	-	714	847	88	2000	3200	NU 236
	320	75	-	772	1080	110	1800	-	319641
	320	86	-	1097	1480	151	2000	3100	NU 2236
	340	100	-	1010	1470	150	1800	-	314525
	380	75	-	1031	1270	123	1500	1900	NU 336
	380	126	-	1587	2260	218	1400	2800	NU 2336
	440	95	-	1268	1580	148	1500	-	NU 436
190	260	33	-	246	400	40,5	2400	-	NU 1938
	260	42	-	260	449	46,9	2400	-	NU 2938
	290	46	-	342	497	53	2400	3300	NU 1038
	290	60	-	651	1030	107	2000	-	NU 2038
	290	75	-	730	1230	130	2000	-	NU 3038
	340	55	-	802	962	98	1900	3000	NU 238

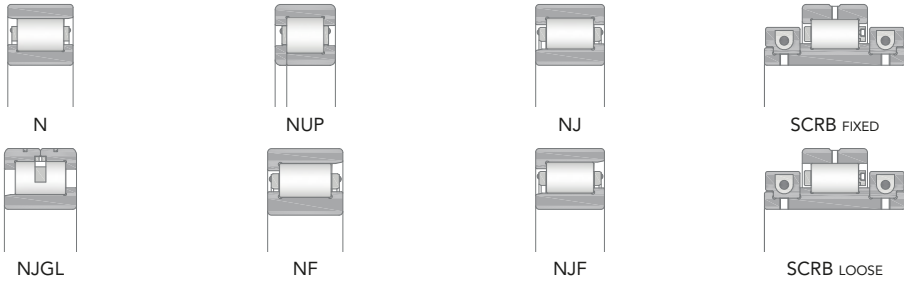

Dimensions					Mass	Designation		
d	r _{1,2min}	r _{3,4min}	r _{amax}	r _{bmax}		Standard design	Alternative design	Angle ring
[mm]					[kg]			
160	4	4	3	3	32,5	NU 332	N, NJ, NUP	HJ 332
(cont.)	4	4	3	3	53	NU 2332	N, NJ, NUP	-
165,1	4	4	3	3	23	322832	-	-
170	2	1,1	1	1	3,55	NU 1934	N, NJ, NUP	-
	2,1	2,1	2	2	8	NU 1034	N, NJ, NUP	HJ 1034
	2,1	2,1	2	2	11	NU 2034	N, NJ, NUP	HJ 234
	4	4	3	3	19	NU 234	N, NJ, NUP	HJ 2234
	4	4	3	3	30	NU 2234	N, NJ, NUP	-
	4	3	3	3	37,5	NU 334	N, NJ, NUP	-
	4	4	3	3	63	NU 2334	N, NJ, NUP	-
180	2	1	2	1	5,05	NU 1936	N, NJ, NUP	-
	2	2	2	2	6,7	NU 2936	N, NJ, NUP	-
	2,1	2,1	2	2	10,5	NU 1036	N, NJ, NUP	HJ 1036
	2,1	2,1	2	2	14	NU 2036	N, NJ, NUP	-
	2,1	1	1	1	17	NU 3036	N, NJ, NUP	-
	4	4	3	3	19,5	NU 236	N, NJ, NUP	HJ 236
	7,5	4	3	3	27,5	319641	-	-
	4	4	3	3	31,5	NU 2236	N, NJ, NUP	-
	4	4	3	3	43,5	314525	-	HJ 2236
	4	3	3	3	44,5	NU 336	N, NJ, NUP	-
	4	4	3	3	72,5	NU 2336	N, NJ, NUP	-
	6	6	5	5	79	NU 436	N, NJ, NUP	-
190	2	1,1	2	1	5,5	NU 1938	N, NJ, NUP	-
	2	2	2	2	7	NU 2938	N, NJ, NUP	-
	2,1	2,1	2	2	11	NU 1038	N, NJ, NUP	HJ 1038
	2,1	2,1	2	2	15	NU 2038	N, NJ, NUP	-
	2,1	1,7	2	1,5	18	NU 3038	N, NJ, NUP	-
	4	4	3	3	23,5	NU 238	N, NJ, NUP	HJ 238

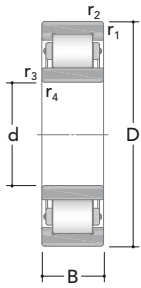

NU

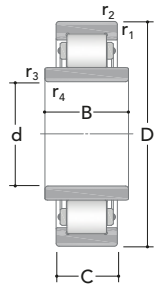

NUB

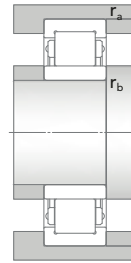

Main dimensions				Basic load ratings		Fatigue load limit	Speed ratings		Designation
d	D	B	C	Dynamic C	Static C ₀	C _u	Reference	Limiting	Standard design
[mm]				[kN]			[rpm]		
190 (cont.)	340	92	-	1232	1640	164	1800	2900	NU 2238
	400	78	-	1141	1470	140	1400	1700	NU 338
	400	132	-	1851	2564	237	1400	2700	NU 2338
200	250	30	-	185	341	33,1	2500	-	NU 2840
	280	38	-	266	397	40,7	2600	-	NU 1940
	280	48	-	325	576	59	2400	-	NU 2940
	310	51	-	376	559	57,4	2100	3100	NU 1040
	310	66	-	744	1200	123	1800	-	NU 2040
	310	82	-	780	1390	145	1800	-	NU 3040
	340	112	-	1201	1880	191	1500	-	NU 3140
	360	58	-	879	1040	104	1700	2800	NU 240
	360	98	-	1351	1880	188	1800	2800	NU 2240
	360	128	-	1556	2440	244	1400	-	NU 3240
	360	143	98	1237	1870	187	1700	-	NUB 326518
	420	80	-	1224	1643	151	1250	2400	NU 340
	420	138	-	1970	2790	254	1300	2500	NU 2340
210	380	61	-	846	1160	114	1600	-	463553
220	300	38	-	338	551	54	2200	-	NU 1944
	300	38	-	279	465	45,5	2200	-	246312
220	300	48	-	455	830	83	2200	-	NU 2944
	340	56	-	492	726	72,6	2000	2800	NU 1044
	340	72	-	878	1450	145	1700	-	NU 2044
	340	90	-	924	1690	169	1600	-	NU 3044
	350	83	-	839	1350	138	1500	-	314591
	370	120	-	1305	2110	207	1400	-	NU 3144
	400	65	-	1059	1275	124	1500	2700	NU 244
	400	108	-	1576	2270	211	1400	2600	NU 2244
	460	88	-	1195	1610	148	1400	1500	NU 344
	460	145	-	2407	3410	306	1200	1900	NU 2344

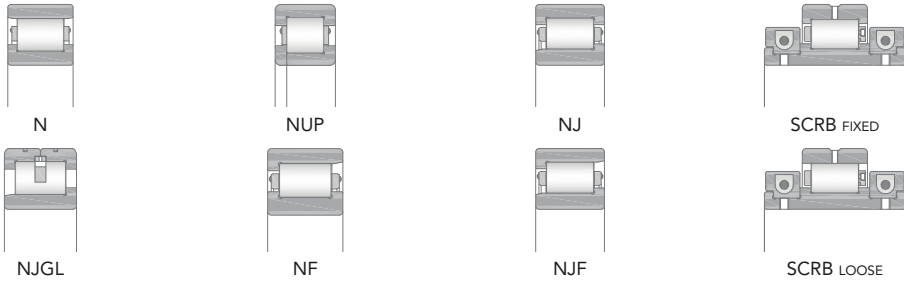

Dimensions					Mass	Designation		
d	r _{1,2min}	r _{3,4min}	r _{amax}	r _{bmax}		Standard design	Alternative design	Angle ring
[mm]					[kg]			
190 (cont.)	4	4	3	3	39	NU 2238	N, NJ, NUP	-
	5	5	4	4	50	NU 338	N, NJ, NUP	HJ 338
	5	5	4	4	82,5	NU 2338	N, NJ, NUP	-
200	1,5	1,5	1,5	1,5	3,55	NU 2840	N, NJ, NUP	-
	2,1	2,1	2	2	7,4	NU 1940	N, NJ, NUP	-
	2,1	2,1	2	2	9,5	NU 2940	N, NJ, NUP	-
	2,1	2,1	2	2	14	NU 1040	N, NJ, NUP	HJ 1040
	2,1	2,1	2	2	19	NU 2040	N, NJ, NUP	-
	2,1	1	2	1	23,5	NU 3040	N, NJ, NUP	-
	3	2	2,5	2	41	NU 3140	N, NJ, NUP	-
	4	4	3	3	28,5	NU 240	N, NJ, NUP	HJ 240
	4	4	3	3	46	NU 2240	N, NJ, NUP	-
	4	4	3	3	59	NU 3240	N, NJ, NUP	-
	4	4	3	3	50	NUB 326518	-	-
	5	5	4	4	56	NU 340	N, NJ, NUP	-
	5	5	4	4	96	NU 2340	N, NJ, NUP	-
210	5	5	4	4	32	463553	-	-
220	2,1	1,5	2	1,5	8,3	NU 1944	N, NJ, NUP	-
	4	2,1	3	2	8	246312	-	-
220	2,1	1,5	2	1,5	10	NU 2944	N, NJ, NUP	-
	3	3	2,5	2,5	18,5	NU 1044	N, NJ, NUP	HJ 1044
	3	3	2,5	2,5	25	NU 2044	N, NJ, NUP	-
	3	1,1	2,5	1	31	NU 3044	N, NJ, NUP	-
	3	3	2,5	2,5	31,5	314591	-	-
	4	1,5	3	1,5	51,5	NU 3144	N, NJ, NUP	-
	4	4	3	3	38,5	NU 244	N, NJ, NUP	-
	4	4	3	3	62,5	NU 2244	N, NJ, NUP	HJ 244
	5	5	4	4	72,5	NU 344	N, NJ, NUP	-
	5	5	4	4	124	NU 2344	N, NJ, NUP	-

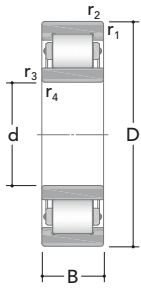

NU

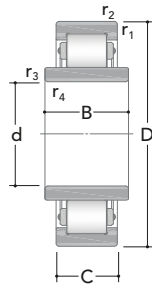

NUB

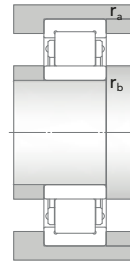

Main dimensions				Basic load ratings		Fatigue load limit	Speed ratings		Designation
d	D	B	C	Dynamic C	Static C ₀	C _u	Reference	Limiting	Standard design
[mm]				[kN]			[rpm]		
220,586	320	45	-	389	623	60	2000	-	411468
220,91	320	45	-	398	623	60	2000	-	413585
229,954	370	100	-	1175	2090	205	1400	-	475618
230	400	120	-	1684	2570	242	1500	-	322380
240	320	48	-	351	663	66	2000	-	NU 2948
	360	56	-	527	789	77	1800	2600	NU 1048
	360	72	-	900	1550	152	1500	-	NU 2048
	360	92	-	1008	1850	182	1500	-	NU 3048
	400	128	-	1452	2432	238	1300	-	NU 3148
	440	72	-	956	1350	127	1500	2000	NU 248
	440	120	-	1433	2330	221	1400	1900	NU 2248
	440	120	-	1587	2490	235	1400	-	313221
	500	95	-	1440	1990	179	1200	1400	NU 348
	500	155	-	2571	3610	316	1100	1800	NU 2348
250	380	83	-	908	1470	143	1500	-	314592
260	320	36	-	285	582	55	1800	-	NU 2852
	340	35	-	349	607	57	1800	-	312235
	340	38	-	344	618	58,3	1800	-	246313
	360	46	-	472	802	79	1700	-	NU 1952
	400	65	-	631	953	95,3	1600	2500	NU 1052
260	400	82	-	1195	2060	198	1400	-	NU 2052
	400	104	-	1340	2332	225	1400	-	NU 3052
	440	144	-	2080	3410	306	1200	-	NU 3152
	480	80	-	1159	1670	147	1300	1800	NU 252
	480	130	-	1766	2960	261	1200	1800	NU 2252
	540	102	-	1930	2680	234	1000	1600	NU 352

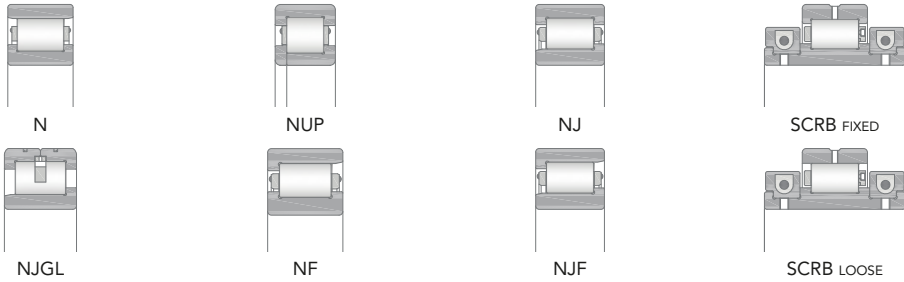

Dimensions					Mass	Designation		
d	r _{1,2min}	r _{3,4min}	r _{amax}	r _{bmax}		Standard design	Alternative design	Angle ring
[mm]					[kg]			
220,586	3	3	2,5	2,5	12,3	411468	-	-
220,91	3	3	2,5	2,5	12,2	413585	-	-
229,954	3	3	2,5	2,5	44,5	475618	-	-
230	3	3	2,5	2,5	74	322380	-	-
240	2,1	2,1	2	2	11,5	NU 2948	N, NJ, NUP	-
	3	3	2,5	2,5	20	NU 1048	N, NJ, NUP	HJ 1048
	3	3	2,5	2,5	26,5	NU 2048	N, NJ, NUP	-
	3	3	2,5	2,5	34	NU 3048	N, NJ, NUP	-
	3	1,1	2,5	1	64	NU 3148	N, NJ, NUP	-
	4	4	3	3	51,5	NU 248	N, NJ, NUP	-
	4	4	3	3	84	NU 2248	N, NJ, NUP	-
	4	4	3	3	84	313221	-	-
	5	5	4	4	94,5	NU 348	N, NJ, NUP	HJ 348
	5	5	4	4	155	NU 2348	N, NJ, NUP	-
250	3	3	2,5	2,5	35,5	314592	-	-
260	2	2	2	2	6,3	NU 2852	N, NJ, NUP	-
	2	2	2	2	8,7	312235	-	-
	4	2	3	2	9,3	246313	-	-
	2,1	1,5	2	1,5	14,5	NU 1952	N, NJ, NUP	-
	4	4	3	3	29,5	NU 1052	N, NJ, NUP	HJ 1052
260	4	4	3	3	39	NU 2052	N, NJ, NUP	-
	4	4	3	3	48	NU 3052	N, NJ, NUP	-
	4	4	3	3	98	NU 3152	N, NJ, NUP	-
	5	5	4	4	68,5	NU 252	N, NJ, NUP	HJ 252
	5	5	4	4	110	NU 2252	N, NJ, NUP	-
	6	6	5	5	125	NU 352	N, NJ, NUP	-

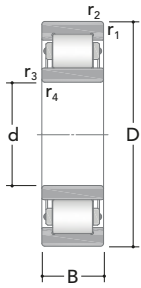

NU

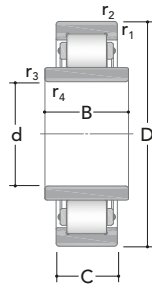

NUB

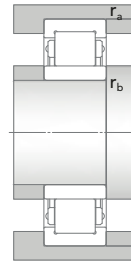

Main dimensions				Basic load ratings		Fatigue load limit	Speed ratings		Designation
d	D	B	C	Dynamic C	Static C ₀	C _u	Reference	Limiting	Standard design
[mm]				[kN]			[rpm]		
260	540	165	-	3182	4410	372	1000	-	NU 2352
(cont.)									
280	350	42	-	362	742	67	1800	-	NU 2856
	360	38	-	378	697	64,3	1700	-	246314
	380	46	-	524	873	82	1700	-	NU 1956
	380	60	-	759	1380	132	1600	-	NU 2956
	420	65	-	668	1050	101	1600	2300	NU 1056
	420	82	-	1237	2130	201	1300	-	NU 2056
	420	82	65	652	1040	100	1500	-	NUB 312961
	460	146	-	2271	3890	334	1100	-	NU 3156
	500	80	-	1296	1923	167	1300	1650	NU 256
	500	130	-	2199	3400	301	1100	1650	NU 2256
	500	165,1	-	2924	4930	424	1000	-	322312
	580	175	-	2723	4220	358	1000	1500	NU 2356
284,9	474,9	152,4	-	2256	4370	412	1100	-	475620
287,6	440	72	-	1066	1700	157	1200	-	463551
300	380	38	-	353	674	60	1600	-	NU 1860
	380	48	-	467	966	87	1600	-	NU 2860
	420	56	-	701	1130	109	1400	-	NU 1960
	420	72	-	997	1880	178	1400	-	NU 2960
	460	74	-	859	1377	130	1400	1700	NU 1060
300	460	95	-	1513	2730	253	1200	-	NU 2060
	460	118	-	1635	3010	281	1200	-	NU 3060
	540	85	-	1435	2100	181	1200	1600	NU 260
	540	140	-	2087	3410	297	1100	1600	NU 2260
	620	185	-	4028	5800	476	900	1400	NU 2360
320	415	43	-	472	848	78	1500	-	246315
	440	72	-	763	1490	139	1400	-	314756

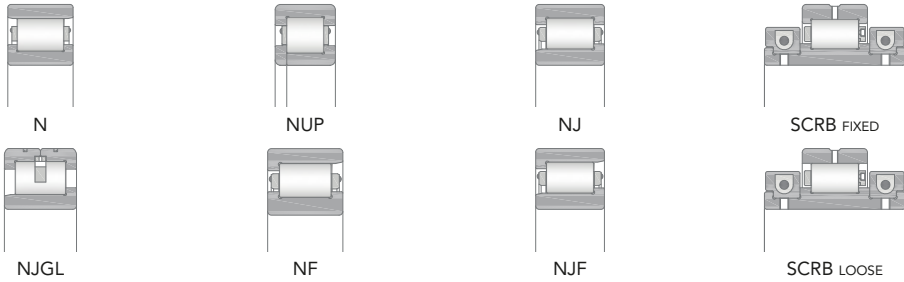

Dimensions					Mass	Designation		
d	r _{1,2min}	r _{3,4min}	r _{amax}	r _{bmax}		Standard design	Alternative design	Angle ring
[mm]					[kg]			
260	6	6	5	5	190	NU 2352	N, NJ, NUP	-
(cont.)								
280	2	1,1	2	1	9,6	NU 2856	N, NJ, NUP	-
	4	2	3	2	9,6	246314	-	-
	2,1	2,1	2	2	15,5	NU 1956	N, NJ, NUP	-
	2,1	2,1	2	2	20,5	NU 2956	N, NJ, NUP	-
	4	4	3	3	31,5	NU 1056	N, NJ, NUP	HJ 1056
	4	4	3	3	40	NU 2056	N, NJ, NUP	-
	4	4	3	3	34	NUB 312961	-	-
	5	5	4	4	105	NU 3156	N, NJ, NUP	-
	5	5	4	4	71,5	NU 256	N, NJ, NUP	-
	5	5	4	4	115	NU 2256	N, NJ, NUP	HJ 2256
	4	4	3	3	160	322312	-	-
	6	6	5	5	232	NU 2356	N, NJ, NUP	-
284,9	4	4	3	3	120	475620	-	-
287,6	6,4	6,4	6	6	42	463551	-	-
300	2,1	1,5	2	1,5	10,5	NU 1860	N, NJ, NUP	-
	2,1	1,5	2	1,5	13,5	NU 2860	N, NJ, NUP	-
	3	3	2,5	2,5	24,5	NU 1960	N, NJ, NUP	-
	3	3	2,5	2,5	33	NU 2960	N, NJ, NUP	-
	4	4	3	3	46,5	NU 1060	N, NJ, NUP	HJ 1060
300	4	4	3	3	59,5	NU 2060	N, NJ, NUP	-
	4	1,5	4	1,5	72	NU 3060	N, NJ, NUP	-
	5	5	4	4	88	NU 260	N, NJ, NUP	-
	5	5	4	4	145	NU 2260	N, NJ, NUP	-
	7,5	7,5	6	6	270	NU 2360	N, NJ, NUP	-
320	4	2,1	3	2	16,2	246315	-	-
	3	3	2,5	2,5	34,5	314756	-	-

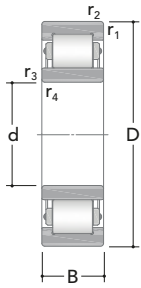

NU

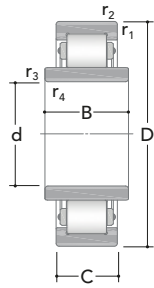

NUB

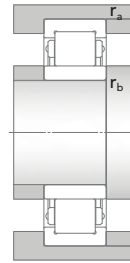

Main dimensions				Basic load ratings		Fatigue load limit C_u	Speed ratings		Designation
d	D	B	C	Dynamic C	Static C_0		Reference	Limiting	
[mm]				[kN]			[rpm]		
320	480	74	-	892	1410	130	1300	1700	NU 1064
(cont.)	480	95	-	1463	2610	241	1100	1700	NU 2064
	480	121	-	1857	3150	280	1100	1200	NU 3064
	540	176	-	3162	5340	445	900	1500	NU 3164
	580	92	-	1606	2410	201	1100	1400	NU 264
	580	150	-	3157	4990	414	1000	1400	NU 2264
	620	165	-	3439	5270	438	900	-	319915
330,15	558,8	141,29	-	2622	4440	375	1000	-	475622
340	420	35	-	213	395	33,1	1400	-	316197
	420	48	-	513	1100	96	1330	-	NU 2868
	460	56	-	692	1180	106	1300	1700	NU 1968
	460	72	-	1023	2010	183	1300	1700	NU 2968
	460,08	56	-	631	1100	100	1300	-	313816
	520	82	-	1089	1740	154	1200	1500	NU 1068
	520	133	-	2205	4080	359	1000	1500	NU 3068
	580	190	-	3477	5829	488	900	1400	NU 3168
	620	165	-	2649	4490	364	1000	1300	NU 2268
350	480	85	-	1054	2130	193	1100	-	612129
360	450	50	-	519	1010	90,6	1300	-	246316
	540	82	-	1116	1810	161	1200	1400	NU 1072
	540	106	-	1924	3590	309	1000	1400	NU 2072
	600	192	-	3439	6153	494	800	1300	NU 3172
	650	95	-	1965	3000	246	900	-	NU 272
	650	170	-	2952	4860	397	900	1200	NU 2272
360	750	224	-	4961	8050	622	700	-	NU 2372
380	480	40	-	270	517	37,3	1200	-	316010
	480	46	-	563	1105	97	1200	1800	NU 1876

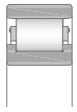

N

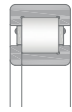

NUP

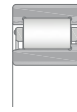

NJ

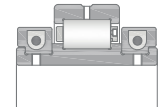

SCRB FIXED

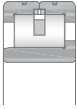

NJGL

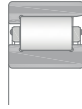

NF

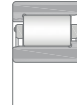

NJF

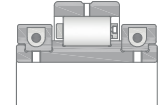

SCRB LOOSE

Dimensions					Mass	Designation		
d	r _{1,2min}	r _{3,4min}	r _{amax}	r _{bmax}		Standard design	Alternative design	Angle ring
[mm]					[kg]			
320	4	4	3	3	48,5	NU 1064	N, NJ, NUP	HJ 1064
(cont.)	4	4	3	3	62,5	NU 2064	N, NJ, NUP	-
	4	4	3	3	75	NU 3064	N, NJ, NUP	-
	5	5	4	4	175	NU 3164	N, NJ, NUP	-
	5	5	4	4	115	NU 264	N, NJ, NUP	-
	5	5	4	4	180	NU 2264	N, NJ, NUP	-
	6	6	5	5	235	319915	-	-
330,15					155	475622	-	-
340	2,1	2,1	2	2	9,6	316197	-	-
	2,1	2,1	2	2	15	NU 2868	N, NJ, NUP	-
	3	3	2,5	2,5	27,5	NU 1968	N, NJ, NUP	-
	3	3	2,5	2,5	37	NU 2968	N, NJ, NUP	-
	3	3	2,5	2,5	27,5	313816	-	-
	5	5	4	4	65	NU 1068	N, NJ, NUP	HJ 1068
	5	5	4	4	106	NU 3068	N, NJ, NUP	-
	5	5	4	4	210	NU 3168	N, NJ, NUP	-
	6	6	5	5	220	NU 2268	N, NJ, NUP	-
350	4	4	3	3	48	612129	-	-
360	4	4	3	3	18,7	246316	-	-
	5	5	4	4	67,5	NU 1072	N, NJ, NUP	HJ 1072
	5	5	4	4	88,5	NU 2072	N, NJ, NUP	-
	5	5	4	4	225	NU 3172	N, NJ, NUP	-
	6	6	5	5	150	NU 272	N, NJ, NUP	-
	6	6	5	5	250	NU 2272	N, NJ, NUP	-
360	7,5	7,5	6	6	510	NU 2372	N, NJ, NUP	-
380	2,1	2,1	2	2	15,5	316010	-	-
	2,1	2,1	2	2	23	NU 1876	N, NJ, NUP	-

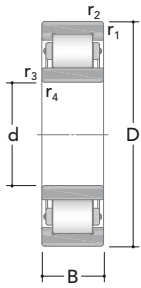

NU

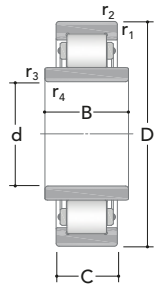

NUB

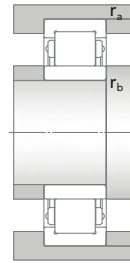

Main dimensions				Basic load ratings		Fatigue load limit	Speed ratings		Designation
d	D	B	C	Dynamic C	Static C ₀	C _u	Reference	Limiting	Standard design
[mm]				[kN]			[rpm]		
380 (cont.)	560	82	-	1152	1910	168	1100	1400	NU 1076
	560	106	-	1910	3700	309	900	1400	NU 2076
	560	135	-	2414	4710	397	900	1600	NU 3076
	680	175	-	4007	6360	507	800	1100	NU 2276
400	500	46	-	571	1170	99	1200	1700	NU 1880
	540	65	-	944	1700	150	1100	1400	NU 1980
	540	82	-	1401	2830	248	1100	1400	NU 2980
	600	90	-	1387	2300	194	1000	1300	NU 1080
	600	118	-	2447	4660	373	900	-	NU 2080
	600	148	-	2816	5450	437	900	1200	NU 3080
406,4	546,1	69,85	-	1118	2000	176	1100	-	322821
	603,25	82,55	-	1489	2512	205	800	-	322815
410	790	215	-	6131	9680	741	700	-	319896
	790	280	-	5575	9040	687	630	-	316931
420	520	40	-	295	608	47,3	1100	-	315932
	520	46	-	555	1100	89,9	1100	1400	NU 1884
	520	75	-	940	2220	191	1000	1400	NU 3884
	560	65	-	975	1789	155	1000	1300	NU 1984
	560	82	-	1421	2871	257	1000	1300	NU 2984
	620	90	-	1425	2473	202	1000	1200	NU 1084
	620	118	-	2360	4700	376	800	1200	NU 2084
	620	150	-	2921	5430	432	800	1200	NU 3084
700	224	-	4981	8990	694	700	1100	NU 3184	
430	530	40	-	294	601	45,8	1100	-	315834
440	540	40	-	292	600	40,8	1000	-	316011
	540	60	-	807	1899	153	1000	1300	NU 2888
	600	74	-	1058	1980	168	1000	1200	NU 1988

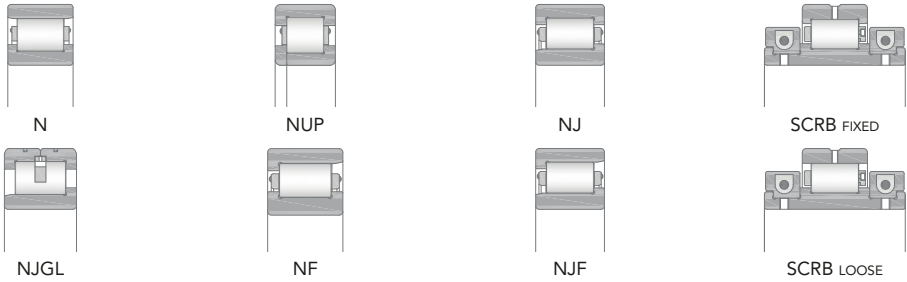

Dimensions					Mass	Designation		
d	r _{1,2min}	r _{3,4min}	r _{amax}	r _{bmax}		Standard design	Alternative design	Angle ring
[mm]					[kg]			
380 (cont.)	5	5	4	4	70	NU 1076	N, NJ, NUP	HJ 1076
	5	5	4	4	92,5	NU 2076	N, NJ, NUP	-
	5	5	4	4	115	NU 3076	N, NJ, NUP	-
	6	6	5	5	275	NU 2276	N, NJ, NUP	-
400	2,1	2,1	2	2	21	NU 1880	N, NJ, NUP	-
	4	4	3	3	41	NU 1980	N, NJ, NUP	-
	4	4	3	3	57	NU 2980	N, NJ, NUP	-
	5	5	4	4	91	NU 1080	N, NJ, NUP	HJ 1080
	5	5	4	4	120	NU 2080	N, NJ, NUP	-
	5	3	4	2,5	175	NU 3080	N, NJ, NUP	-
406,4	5	5	4	4	46,5	322821	-	-
	5	5	4	4	84	322815	-	-
410	7,5	7,5	6	6	500	319896	-	-
	7,5	7,5	6	6	610	316931	-	-
420	2,1	2,1	2	2	17,5	315932	-	-
	2,1	1,5	2	1,5	20	NU 1884	N, NJ, NUP	-
	2,1	1,5	2	1,5	33	NU 3884	N, NJ, NUP	-
	4	4	3	3	48	NU 1984	N, NJ, NUP	-
	4	4	3	3	59	NU 2984	N, NJ, NUP	-
	5	5	4	4	94	NU 1084	N, NJ, NUP	HJ 1084
	5	5	4	4	125	NU 2084	N, NJ, NUP	-
	5	3	4	3	160	NU 3084	N, NJ, NUP	-
	6	6	5	5	380	NU 3184	N, NJ, NUP	-
430	2,1	2,1	2	2	18,5	315834	-	-
440	2,1	2,1	2	2	18,5	316011	-	-
	2,1	2,1	2	2	34	NU 2888	N, NJ, NUP	-
	4	4	3	3	64	NU 1988	N, NJ, NUP	-

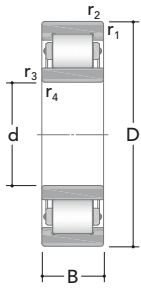

NU

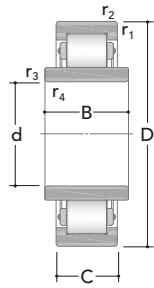

NUB

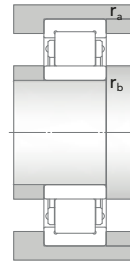

Main dimensions				Basic load ratings		Fatigue load limit	Speed ratings		Designation
d	D	B	C	Dynamic C	Static C ₀	C _u	Reference	Limiting	Standard design
[mm]				[kN]			[rpm]		
440 (cont.)	600	95	-	1883	3882	338	1000	1400	NU 2988
	650	94	-	1493	2630	210	1000	1100	NU 1088
	650	122	-	2581	4860	387	7900	1100	NU 2088
	650	157	-	2608	5360	422	800	-	NU 3088
440	720	226	-	5190	10057	769	620	1100	NU 3188
460	580	56	-	817	1690	139	1000	-	NU 1892
	580	72	-	1087	2374	191	1000	1200	NU 2892
	680	100	-	1653	2810	221	900	1100	NU 1092
	680	128	-	2843	5479	421	700	1100	NU 2092
	680	163	-	3432	6771	526	700	1120	NU 3092
	760	240	-	5210	9610	732	600	1000	NU 3192
460	830	165	-	4119	6750	506	700	1000	NU 1292
	830	212	-	5081	8500	644	700	1000	NU 2292
469,9	596,9	57,15	-	786	1600	120	900	-	635010
	698,5	139,7	-	2999	5590	429	700	-	326097
470	920	246	-	8203	13190	949	500	-	320362
480	600	56	-	764	1610	126	900	1100	NU 1896
	600	72	-	1103	2420	198	900	1100	NU 2896
	650	78	-	1156	2220	181	900	1100	NU 1996
	650	78	-	1332	2530	210	900	-	319164
	700	100	-	1661	2960	229	900	1100	NU 1096
	700	128	-	2852	5510	423	700	1100	NU 2096
	790	248	-	5975	10780	799	600	1000	NU 3196
	500	620	45	-	402	827	45,3	900	900
500	620	56	-	798	1720	137	900	840	NU 18/500
	670	78	-	1224	2395	196	800	-	NU 19/500

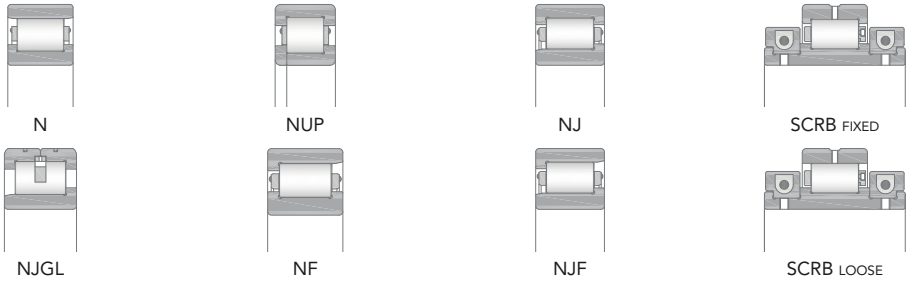

Dimensions					Mass	Designation		
d	r _{1,2min}	r _{3,4min}	r _{amax}	r _{bmax}		Standard design	Alternative design	Angle ring
[mm]					[kg]			
440	4	4	3	3	84	NU 2988	N, NJ, NUP	-
(cont.)	6	6	5	5	105	NU 1088	N, NJ, NUP	HJ 1088
	6	6	5	5	145	NU 2088	N, NJ, NUP	-
	6	4	5	4	180	NU 3088	N, NJ, NUP	-
440	6	6	5	5	395	NU 3188	N, NJ, NUP	-
460	3	3	2,5	2,5	37	NU 1892	N, NJ, NUP	-
	3	3	2,5	2,5	48	NU 2892	N, NJ, NUP	-
	6	6	5	5	125	NU 1092	N, NJ, NUP	HJ 1092
	6	6	5	5	165	NU 2092	N, NJ, NUP	-
	6	6	5	5	210	NU 3092	N, NJ, NUP	-
	7,5	7,5	6	6	455	NU 3192	N, NJ, NUP	-
460	7,5	7,5	6	6	415	NU 1292	N, NJ, NUP	-
	7,5	7,5	6	6	530	NU 2292	N, NJ, NUP	-
469,9	3	3	2,5	2,5	40,5	635010	-	-
	6	6	5	5	200	326097	-	-
470	9,5	9,5	8	8	750	320362	-	-
480	3	3	2,5	2,5	39	NU 1896	N, NJ, NUP	-
	3	3	2,5	2,5	47,5	NU 2896	N, NJ, NUP	-
	5	5	4	4	75,5	NU 1996	N, NJ, NUP	-
	5	5	4	4	78	319164	-	-
	6	6	5	5	130	NU 1096	N, NJ, NUP	HJ 1096
	6	6	5	5	170	NU 2096	N, NJ, NUP	-
	7,5	7,5	6	6	500	NU 3196	N, NJ, NUP	-
500	2,1	2,1	2	2	29	316198	-	-
	3	3	2,5	2,5	39	NU 18/500	N, NJ, NUP	-
	5	5	4	4	79	NU 19/500	N, NJ, NUP	-

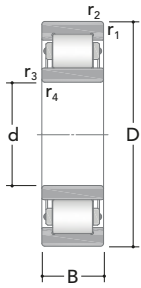

NU

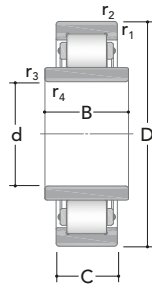

NUB

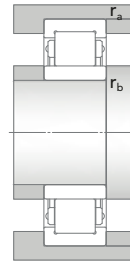

Main dimensions				Basic load ratings		Fatigue load limit	Speed ratings		Designation
d	D	B	C	Dynamic C	Static C ₀	C _u	Reference	Limiting	Standard design
[mm]				[kN]			[rpm]		
500 (cont.)	670	128	-	2304	5130	434	700	1100	NU 39/500
	720	100	-	1729	3040	231	800	1000	NU 10/500
	720	128	-	2930	5840	439	700	1000	NU 20/500
	720	167	-	3870	7950	606	700	1000	NU 30/500
	830	264	-	6490	11850	869	550	900	NU 31/500
	920	185	-	5249	8360	610	600	850	NU 12/500
530	650	45	-	415	890	61	2000	3000	315835
	650	72	-	1163	2720	214	800	1100	NU 28/530
	710	106	-	2354	4950	411	800	-	NU 29/530
	780	112	-	2310	4030	303	800	900	NU 10/530
	780	145	-	3791	7340	549	600	900	NU 20/530
	780	185	-	4123	8620	638	600	-	NU 30/530
	870	272	-	7453	14690	1046	500	840	NU 31/530
560	680	45	-	435	940	61	1800	2700	316053
	680	56	-	807	2062	152	800	1000	NU 18/560
	750	85	-	1645	3405	250	700	900	NU 19/560
	820	115	-	2359	4210	307	700	900	NU 10/560
	820	150	-	3752	7560	553	600	900	NU 20/560
	1030	206	-	7140	11000	766	500	700	NU 12/560
571,5	711,2	120,65	-	2457	6190	474	600	-	474795
600	730	52	-	465	1010	64,9	700	-	315836
	730	60	-	910	2068	107	700	900	NU 18/600
	800	90	-	1914	3790	274	700	830	NU 19/600
	800	118	-	2958	6520	473	700	850	NUP 29/600
	870	118	-	2761	5010	359	700	800	NU 10/600
	870	155	-	4186	7880	561	600	800	NU 20/600
	870	200	-	5419	10780	764	600	800	NU 30/600
	1090	155	-	5531	9790	669	500	650	NU 12/600

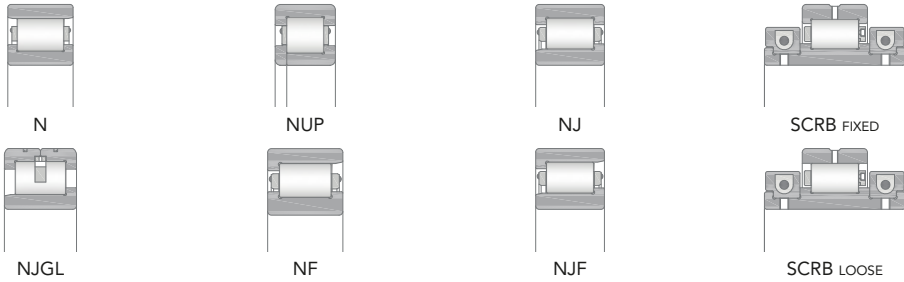

Dimensions					Mass	Designation		
d	r _{1,2min}	r _{3,4min}	r _{amax}	r _{bmax}		Standard design	Alternative design	Angle ring
[mm]					[kg]			
500	5	5	4	4	130	NU 39/500	N, NJ, NUP	-
(cont.)	6	6	5	5	135	NU 10/500	N, NJ, NUP	HJ 10/500
	6	6	5	5	180	NU 20/500	N, NJ, NUP	-
	6	6	5	5	225	NU 30/500	N, NJ, NUP	-
	7,5	7,5	6	6	595	NU 31/500	N, NJ, NUP	-
	7,5	7,5	6	6	585	NU 12/500	N, NJ, NUP	-
530	3	3	2,5	2,5	30	315835	-	-
	3	3	2,1	2,1	52	NU 28/530	N, NJ, NUP	-
	5	5	4	4	120	NU 29/530	N, NJ, NUP	-
	6	6	5	5	190	NU 10/530	N, NJ, NUP	-
	6	6	5	5	255	NU 20/530	N, NJ, NUP	-
	6	3	5	3	310	NU 30/530	N, NJ, NUP	-
	7,5	4	6	3	680	NU 31/530	N, NJ, NUP	-
560	3	3	2,5	2,5	31,5	316053	-	-
	3	3	2,5	2,5	44,5	NU 18/560	N, NJ, NUP	-
	5	5	4	4	110	NU 19/560	N, NJ, NUP	-
	6	6	5	5	210	NU 10/560	N, NJ, NUP	HJ 10/560
	6	6	5	5	290	NU 20/560	N, NJ, NUP	-
	9,5	9,5	8	8	805	NU 12/560	N, NJ, NUP	-
571,5	5	5	4	4	115	474795	-	-
600	3	3	2,5	2,5	41	315836	-	-
	3	3	2,5	2,5	50,5	NU 18/600	N, NJ, NUP	-
	5	5	4	4	130	NU 19/600	N, NJ, NUP	-
	5	5	4	4	165	NUP 29/600	N, NJ, NUP	-
	6	6	5	5	245	NU 10/600	N, NJ, NUP	HJ 10/600
	6	6	5	5	325	NU 20/600	N, NJ, NUP	-
	6	6	5	5	415	NU 30/600	N, NJ, NUP	-
	9,5	9,5	8	8	710	NU 12/600	N, NJ, NUP	-

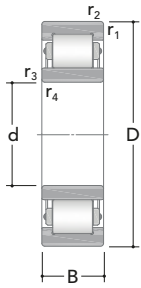

NU

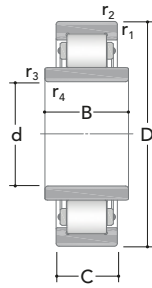

NUB

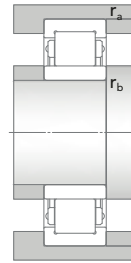

Main dimensions				Basic load ratings		Fatigue load limit	Speed ratings		Designation
d	D	B	C	Dynamic C	Static C ₀	C _u	Reference	Limiting	Standard design
[mm]				[kN]			[rpm]		
630	780	56	-	598	1270	84	1600	2200	315933
	780	88	-	1585	3850	289	700	830	NU 28/630
	780	112	-	2191	5650	446	600	600	NU 38/630
	850	100	-	2228	4350	311	630	800	NU 19/630
	850	128	-	3335	7130	505	700	800	NU 29/630
	920	128	-	3381	6110	424	600	800	NU 10/630
	920	170	-	4731	9420	664	500	800	NU 20/630
	920	212	-	6407	14120	987	500	-	NU 30/630
	1150	230	-	8699	13470	900	400	600	NU 12/630
640	790	56	-	611	1294	83	1600	2000	315837
660,4	863,6	107,95	-	3119	6450	448	500	600	464777
670	820	56	-	615	1360	82	1500	2000	316012
	820	69	-	1236	2750	200	600	-	NU 18/670
	900	103	-	2360	4660	319	600	730	NU 19/670
	980	136	-	3709	6730	460	600	700	NU 10/670
	980	180	-	5438	10780	735	480	700	NU 20/670
	980	230	-	6953	14730	1021	450	-	NU 30/670
673,1	838,2	117,475	-	3000	7160	537	600	-	316912
710	870	74	-	1447	3328	189	600	740	NU 18/710
	870	95	-	1919	4930	360	600	740	NU 28/710
	950	140	-	3767	8200	563	530	700	NU 29/710
	1030	140	-	4747	8400	563	500	700	NU 10/710
	1030	185	-	5852	11840	804	500	600	NU 20/710
720	880	62	-	697	1540	90,3	1300	1625	315799
750	920	78	-	1474	3390	163	540	640	NU 18/750
	1000	112	-	2716	5500	358	500	-	319166

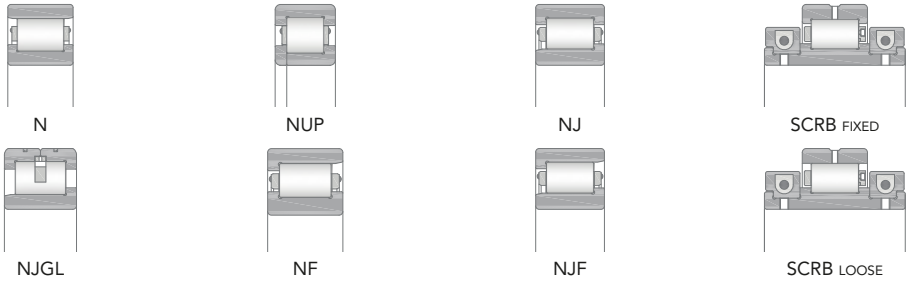

Dimensions					Mass	Designation		
d	r _{1,2min}	r _{3,4min}	r _{amax}	r _{bmax}		Standard design	Alternative design	Angle ring
[mm]					[kg]			
630	4	4	3	3	55	315933	-	-
	4	4	3	3	100	NU 28/630	N, NJ, NUP	-
	4	4	3	3	120	NU 38/630	N, NJ, NUP	-
	6	6	5	5	165	NU 19/630	N, NJ, NU	-
	6	6	5	5	220	NU 29/630	N, NJ, NUP	-
	7,5	7,5	6	6	285	NU 10/630	N, NJ, NUP	-
	7,5	7,5	6	6	400	NU 20/630	N, NJ, NUP	-
	7,5	7,5	6	6	490	NU 30/630	N, NJ, NUP	-
	12	12	10	10	1110	NU 12/630	N, NJ, NUP	-
640	4	4	3	3	56	315837	-	-
660,4	5	5	4	4	177	464777	-	-
670	3	3	2,5	2,5	60	316012	-	-
	4	4	3	3	84,5	NU 18/670	N, NJ, NUP	-
	6	6	5	5	195	NU 19/670	N, NJ, NUP	-
	7,5	7,5	6	6	350	NU 10/670	N, NJ, NUP	-
	7,5	7,5	6	6	480	NU 20/670	N, NJ, NUP	-
	7,5	4	6	3	595	NU 30/670	N, NJ, NUP	-
673,1	5	5	4	4	160	316912	-	-
710	4	4	3	3	97,5	NU 18/710	N, NJ, NUP	-
	4	4	3	3	130	NU 28/710	N, NJ, NUP	-
	6	6	5	5	295	NU 29/710	N, NJ, NUP	-
	7,5	7,5	6	6	415	NU 10/710	N, NJ, NUP	-
	7,5	7,5	6	6	540	NU 20/710	N, NJ, NUP	-
720	4	4	3	3	74,5	315799	-	-
750	5	5	4	4	110	NU 18/750	N, NJ, NUP	-
	6	6	5	5	255	319166	-	-

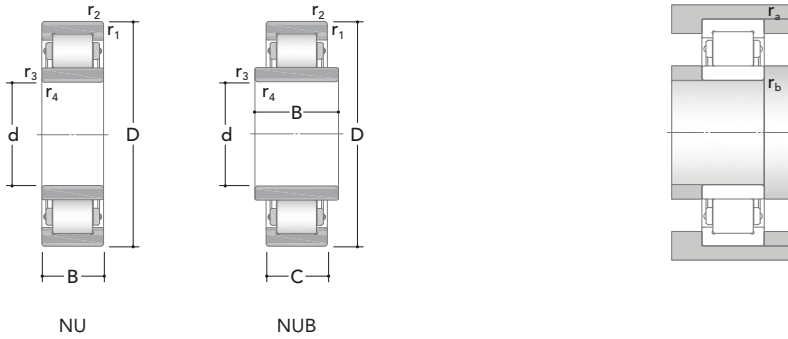

Main dimensions				Basic load ratings		Fatigue load limit C _u	Speed ratings		Designation
d	D	B	C	Dynamic C	Static C ₀		Reference	Limiting	
[mm]				[kN]		[rpm]		Standard design	
750	1090	150	-	4718	8720	580	410	600	NU 10/750
(cont.)	1090	195	-	7060	14428	968	410	600	NU 20/750
800	980	82	-	1719	4090	276	480	600	NU 18/800
	1150	155	-	5456	10490	688	430	550	NU 10/800
	1150	200	-	7023	14400	937	380	600	NU 20/800
820	990	72	-	858	1930	110	1120	1400	315800
850	1030	74	-	934	2080	120	1110	1400	316200
	1030	106	-	2122	5940	238	460	600	NU 28/850
	1120	118	-	3347	7160	459	450	520	NU 19/850
	1120	155	-	4648	10990	707	-	-	NU 29/850
900	1090	85	-	1965	4810	236	420	530	NU 18/900
	1090	112	-	2666	7150	472	410	390	NU 28/900
	1180	122	-	4110	8700	554	390	500	NU 19/900
	1180	165	-	5590	13860	887	380	480	NU 29/900
1000	1220	100	-	2614	6490	396	360	470	NU 18/1000
	1220	128	-	3570	9890	609	370	470	NU 28/1000
	1220	128	100	2624	6510	398	350	460	NUB 18/1000
	1320	185	-	6994	17070	1066	-	-	NU 29/1000
1030	1250	100	-	1490	3440	172	290	330	319579
1060	1280	100	-	1493	3390	216	-	-	316789
	1280	128	-	3809	10220	631	280	320	NU 28/1060
	1400	195	-	7236	17260	1058	250	390	NU 29/1060
	1400	250	-	9136	23880	1453	240	290	NU 39/1060
	1500	325	-	13020	32280	1937	-	-	NU 30/1060
1120	1360	104	-	1632	3845	227	200	250	316201

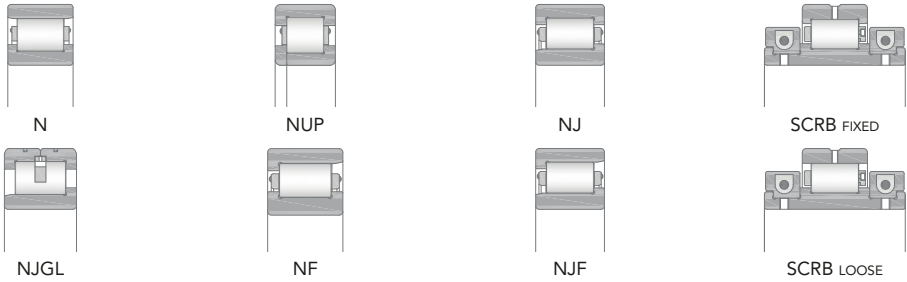

Dimensions					Mass	Designation		
d	r _{1,2min}	r _{3,4min}	r _{amax}	r _{bmax}		Standard design	Alternative design	Angle ring
[mm]					[kg]			
750	7,5	7,5	6	6	490	NU 10/750	N, NJ, NUP	-
(cont.)	7,5	7,5	6	6	635	NU 20/750	N, NJ, NUP	-
800	5	5	4	4	145	NU 18/800	N, NJ, NUP	-
	7,5	7,5	6	6	560	NU 10/800	N, NJ, NUP	-
	7,5	7,5	6	6	715	NU 20/800	N, NJ, NUP	-
820	5	5	4	4	100	315800	-	-
850	5	5	4	4	115	316200	-	-
	5	5	4	4	190	NU 28/850	N, NJ, NUP	-
	6	6	5	5	330	NU 19/850	N, NJ, NUP	-
	6	6	5	5	430	NU 29/850	N, NJ, NUP	-
900	5	5	4	4	170	NU 18/900	N, NJ, NUP	-
	5	5	4	4	235	NU 28/900	N, NJ, NUP	-
	6	6	5	5	380	NU 19/900	N, NJ, NUP	-
	6	6	5	5	560	NU 29/900	N, NJ, NUP	-
1000	6	6	5	5	265	NU 18/1000	N, NJ, NUP	-
	6	6	5	5	350	NU 28/1000	N, NJ, NUP	-
	6	6	5	5	287	NUB 18/1000	N, NJ, NUP	-
	7,5	7,5	6	6	700	NU 29/1000	N, NJ, NUP	-
1030	6	6	5	5	225	319579	-	-
1060	6	6	5	5	230	316789	-	-
	6	6	5	5	360	NU 28/1060	N, NJ, NUP	-
	7,5	7,5	6	6	870	NU 29/1060	N, NJ, NUP	-
	7,5	7,5	6	6	1070	NU 39/1060	N, NJ, NUP	-
	9,5	9,5	8	8	1900	NU 30/1060	N, NJ, NUP	-
1120	6	6	5	5	285	316201	-	-

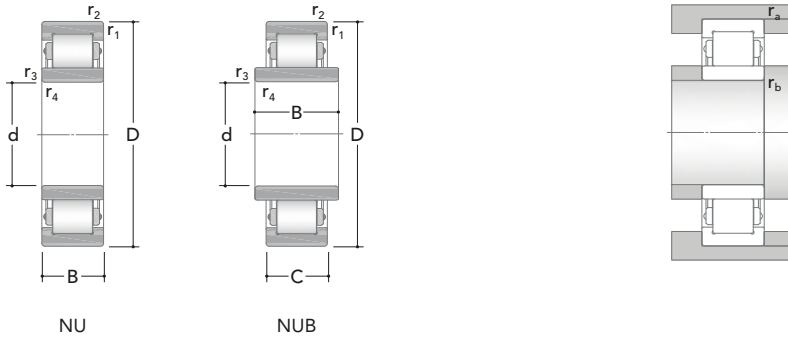

Main dimensions				Basic load ratings		Fatigue load limit	Speed ratings		Designation
d	D	B	C	Dynamic C	Static C ₀	C _u	Reference	Limiting	Standard design
[mm]				[kN]			[rpm]		
1120 (cont.)	1360	106	-	3397	8620	508	320	380	NU 18/1120
	1580	345	-	15683	38490	2290	180	210	NU 30/1120
1180	1420	106	-	3059	7730	451	290	360	NU 18/1180
	1540	206	-	9037	21500	1284	170	330	NU 29/1180
	1540	272	-	11221	28470	1698	180	340	NU 39/1180
1250	1500	106	-	1732	4080	236	200	250	315913
	1750	290	-	12950	30460	1758	150	170	NU 20/1250
1320	1600	122	-	4460	11241	646	240	300	NU 18/1320
				11472	30090	1736	-	-	
	1720	300	-	13100	34719	1972	200	280	NU 39/1320
	1850	400	-	21359	54780	3088	170	210	NU 30/1320
1400	1700	175	-	6694	18250	1037	200	320	NU 28/1400
1500	1820	140	-	3317	7950	437	180	220	319301
1700	2060	160	-	3694	9040	484	150	180	319286
1900	2300	175	-	8693	24620	1270	-	-	NU 18/1900

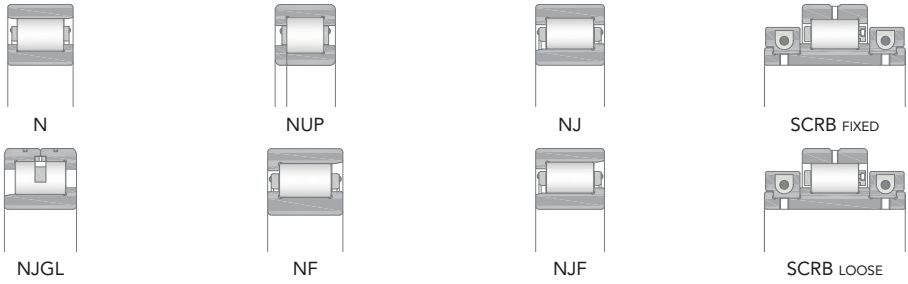

Dimensions					Mass	Designation		
d	r _{1,2min}	r _{3,4min}	r _{amax}	r _{bmax}		Standard design	Alternative design	Angle ring
[mm]					[kg]			
1120	6	6	5	5	335	NU 18/1120	N, NJ, NUP	-
(cont.)	9,5	9,5	8	8	2150	NU 30/1120	N, NJ, NUP	-
1180	6	6	5	5	350	NU 18/1180	N, NJ, NUP	-
	7,5	7,5	6	6	1050	NU 29/1180	N, NJ, NUP	-
	7,5	7,5	6	6	1400	NU 39/1180	N, NJ, NUP	-
1250	6	6	5	5	330	315913	-	-
	9,5	9,5	8	8	2320	NU 20/1250	N, NJ, NUP	-
1320	6	6	5	5	530	NU 18/1320	N, NJ, NUP	-
	7,5	7,5	6	6	1900	NU 39/1320	N, NJ, NUP	-
	12	12	10	10	3550	NU 30/1320	N, NJ, NUP	-
1400	7,5	7,5	6	6	860	NU 28/1400	N, NJ, NUP	-
1500	7,5	7,5	6	6	665	319301	-	-
1700	7,5	7,5	6	6	925	319286	-	-
1900	9,5	9,5	8	8	1480	NU 18/1900	N, NJ, NUP	-

Single row full complement cylindrical roller bearings

Radial internal clearance

Single row full complement cylindrical roller bearings are produced as standard with Normal radial internal clearance CN, but they are available with C2, C3, C4 and C5 radial clearance, in accordance with the ISO 5753:2009.

The radial internal clearance values are reported in the previous **Tab. 1 page 127** and **Tab. 2 page 128**, for cylindrical and tapered bore respectively, and they are valid only for bearing unmounted and unloaded.



Single row full complement cylindrical roller bearing

Misalignment

The permissible misalignment between the shaft and the seat of a single row full complement cylindrical roller bearing is restricted to a few minutes of arc:

- 4 minutes of arc for bearings of the narrow dimensional series 18
- 3 minutes of arc for bearings of the wider dimensional series 22, 23, 28, 29 and 30

The above values can be used for the non-

locating bearings, if the shaft and housing axes remain unchanged. Larger values of misalignment may be used, but with negative consequences regarding the bearing life. For additional information, please consult the RKB application engineering service.

Minimum load

A minimum radial load is requested for a single row full complement cylindrical roller bearings to allow an the correct functioning, especially in critical working conditions like: high speed, high acceleration and sudden changes of rotating direction. In these operating conditions, a sliding movement between rollers and raceways can take place by the inertial forces, influencing negatively the bearing life. Minimum radial load can be theoretically estimated using this formula:

$$F_{rm} > \frac{C_{0r}}{50}$$

Where:

- F_{rm} minimum radial load, [kN];
- C_{0r} basic static load rating, [kN].

Usually, the minimum radial load is reached or surpassed by the weight of the components supported by the bearing together with the loads acting on it, otherwise supplementary radial load must be applied on the single row full complement cylindrical roller bearing. In application where a starting up at a low temperature is planned or a lubricant with high viscosity is used, a larger value of the minimum radial load is required.

Axial load carrying capacities

RKB Single row full complement cylindrical roller bearings can be used in one direction locating position, withstanding axial loads combined with radial force.

In order to support continuous axial loads in one direction the bearing ribs have to be supported across their full height. The maximum axial load has to be in compliance with the following disequations:

$$F_a \leq 0,4 F_r$$

$$F_a \leq \frac{K_1 \cdot K_2 \cdot d_m^{1,5} \cdot n^{-0,6}}{1000}$$

$$F_a \leq \frac{K_2 \cdot d_m^2}{1000}$$

Where:

- F_a maximum axial load, [kN];
- K_1 experimental factor connected with lubrication system, [kN] see following **Tab. 4 page 130**;
- K_2 experimental factor connected with bearing series see following **Tab. 5 page 171**;
- n operating speed [rpm];
- d_m mean bearing diameter [mm];

Series	Factor K_2
NCF18	0,33
NCF29	0,75
NCF30	1,23
NCF22	1,43
NJG23	2,18

Tab. 5 - Experimental Factor K_2

For additional information regarding the above limits please consult the RKB application engineering services.

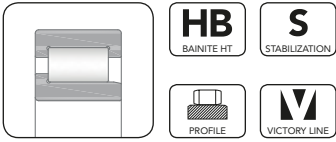
Type NJG (SL19)

- Outer ring with two integral side ribs
- Inner ring with one integral side rib
- Full complement (cageless) separable design for increased carrying capacities
- Reduced maximum rotational speed compared to caged design
- Optimized raceway geometry and roller profile
- Can be used in one direction locating position

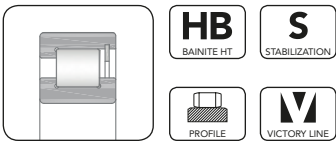
Type NCF (SL18)

- Outer ring with one integral side rib and retaining ring
- Inner ring with two integral side ribs
- Full complement (cageless) design for increased load carrying capacities
- Reduced maximum rotational speed compared to caged design
- Optimized raceway geometry and roller profile
- Can be used in one direction locating position

Suffixes	Internal Design
E	Optimized internal design with reinforced execution
EC	Optimized internal design for increased load ratings
SP	Special or non-standard bearing
V	Full complement of rolling elements (without cage)
ZB	Optimized roller profile for improved load distribution. It is not necessarily stated in the bearing code

Suffixes	Accuracy, clearance, running
C2	Radial internal clearance less than CN
CN	Standard radial internal clearance
C3	Radial internal clearance greater than Normal (CN)
C4	Radial internal clearance greater than C3
C5	Radial internal clearance greater than C4
CS	Special radial internal clearance
P6	Dimensional and running accuracy as per ISO tolerances Class 6

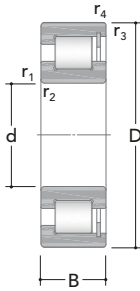

NCF (SL18)

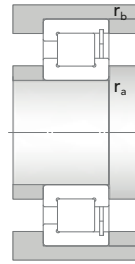

Main dimensions			Basic load ratings		Fatigue load limit C_u	Speed ratings		Designation
d	D	B	Dynamic C	Static C_0		Reference	Limiting	
[mm]			[kN]			[rpm]		
20	42	16	28	28,3	3,1	8200	8700	NCF 3004
	47	18	42	36,2	3,8	6200	8300	NCF 2204
25	47	16	32,4	35,4	3,8	6700	7900	NCF 3005
	52	18	47,6	42,3	4,2	5500	8100	NCF 2205
	62	24	69,1	67,8	8,5	4300	4800	NJG 2305
30	55	19	85,3	86,5	11	5800	6500	NCF 3006
	62	20	68,1	62,8	8,1	4600	6200	NCF 2206
	72	27	83	85,2	5,2	3800	4300	NJG 2306
35	62	20	48,6	55,4	6,48	5100	6000	NCF 3007
	72	23	86	77,1	9,1	4100	5800	NCF 2207
	80	31	106	113	14,2	3200	3800	NJG 2307
40	68	21	57,2	69,4	8,14	4600	5300	NCF 3008
	80	23	95,1	89,2	12,3	3470	4750	NCF 2208
	90	33	145	153	20	2800	3200	NJG 2308
45	75	23	59,8	76,5	8,97	4100	4600	NCF 3009
	85	23	96,8	100	13,2	3480	4500	NCF 2209
	100	36	173	197	25,6	2700	2900	NJG 2309
50	80	23	75,6	97,2	11,7	3800	4400	NCF 3010
	90	23	107	111	13,7	3400	4100	NCF 2210
55	90	26	104	138	17,1	3300	3700	NCF 3011
	100	25	138	147	18,4	2600	3500	NCF 2211
	120	43	231	255	32,9	2100	2400	NJG 2311
60	85	16	54,8	78,6	8,99	3400	4000	NCF 2912
	95	26	106	145	18,2	3200	3500	NCF 3012
	110	28	164	171	21,3	2500	3400	NCF 2212

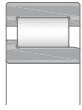

NJG (SL19)

Dimensions					Mass	Designation
d	r _{1,2min}	r _{3,4min}	r _{amax}	r _{bmax}		Standard design
[mm]					[kg]	
20	0,6	0,3	0,6	0,3	0,11	NCF 3004
	1	-	1	-	0,16	NCF 2204
25	0,6	0,3	0,6	0,3	0,12	NCF 3005
	1	-	1	-	0,18	NCF 2205
	1,1	-	1	-	0,38	NJG 2305
30	1	0,3	1	0,3	0,2	NCF 3006
	1	-	1	-	0,3	NCF 2206
	1,1	-	1	-	0,56	NJG 2306
35	1	0,3	1	0,3	0,26	NCF 3007
	1,1	-	1,1	-	0,44	NCF 2207
	1,5	-	1,5	-	0,75	NJG 2307
40	1	0,3	1	0,3	0,31	NCF 3008
	1,1	-	1,1	-	0,55	NCF 2208
	1,5	-	1,5	-	1	NJG 2308
45	1	0,3	1	0,3	0,4	NCF 3009
	1,1	-	1,1	-	0,59	NCF 2209
	1,5	-	1,5	-	1,45	NJG 2309
50	1	0,3	1	0,3	0,43	NCF 3010
	1,1	-	1,1	-	0,64	NCF 2210
55	1,1	0,6	1	0,6	0,64	NCF 3011
	1,5	-	1,5	-	0,87	NCF 2211
	2	-	2	-	2,3	NJG 2311
60	1	0,6	1	0,5	0,29	NCF 2912
	1,1	0,6	1	0,5	0,69	NCF 3012
	1,5	-	1,5	-	1,18	NCF 2212

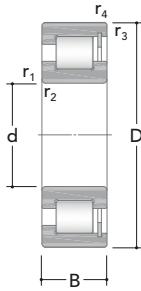

NCF (SL18)

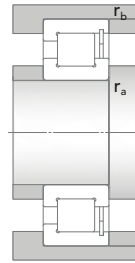

Main dimensions			Basic load ratings		Fatigue load limit C_u	Speed ratings		Designation
d	D	B	Dynamic C	Static C_0		Reference	Limiting	Standard design
[mm]			[kN]			[rpm]		
65	90	16	59,1	87,3	10,1	3100	3500	NCF 2913
	100	26	111	161	20	2900	3400	NCF 3013
	120	31	194	208	26,6	2370	3100	NCF 2213
	140	48	303	357	46,1	1800	2100	NJG 2313
70	100	19	75,4	116	13,7	2900	3300	NCF 2914
	110	30	126	171	22,1	2600	3100	NCF 3014
	125	31	179	219	27,1	2200	2960	NCF 2214
	150	51	332	393	49	1700	1900	NJG 2314
75	105	19	79,6	124	14,5	2700	3200	NCF 2915
	115	30	135	189	24,4	2500	2800	NCF 3015
	130	31	183	231	29,4	2100	2750	NCF 2215
	160	55	399	478	60	1500	1800	NJG 2315
80	110	19	81,2	130	15,4	2500	3000	NCF 2916
	125	34	165	227	29	2300	2600	NCF 3016
	140	33	217	277	35,2	2000	2840	NCF 2216
	170	58	460	562	70	1400	1700	NJG 2316
85	120	22	103	163	20	2500	2800	NCF 2917
	130	34	174	233	30	2300	2600	NCF 3017
	150	36	249	315	37,3	1970	2500	NCF 2217
	180	60	487	617	76,1	1300	1600	NJG 2317
90	125	22	104	176	20,8	2300	2600	NCF 2918
	140	37	198	278	35,2	2100	2400	NCF 3018
	160	40	281	363	46,8	1900	2300	NCF 2218
	190	64	553	684	83	1300	1500	NJG 2318
95	170	43	324	424	51,2	1800	2100	NCF 2219
100	140	24	129	198	24,3	2100	2200	NCF 2920

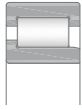

NJG (SL19)

Dimensions					Mass	Designation
d	r _{1,2min}	r _{3,4min}	r _{amax}	r _{bmax}		Standard design
[mm]					[kg]	
65	1	0,6	1	0,5	0,31	NCF 2913
	1,1	0,6	1	0,5	0,73	NCF 3013
	1,5	-	1,5	-	1,57	NCF 2213
	2,1	-	2	-	3,55	NJG 2313
70	1	0,6	1	0,5	0,49	NCF 2914
	1,1	0,6	1	0,5	1	NCF 3014
	1,5	-	1,5	-	1,66	NCF 2214
	2,1	-	2	-	4,4	NJG 2314
75	1	0,6	1	0,5	0,52	NCF 2915
	1,1	1,1	1	1	1,05	NCF 3015
	1,5	-	1,5	-	1,75	NCF 2215
	2,1	-	2	-	5,35	NJG 2315
80	1	0,6	1	0,5	0,55	NCF 2916
	1,1	0,6	1	0,5	1,45	NCF 3016
	2	-	2	-	2,15	NCF 2216
	2,1	-	2	-	6,4	NJG 2316
85	1,1	1	1	1	0,81	NCF 2917
	1,1	0,6	1	0,5	1,5	NCF 3017
	2	-	2	-	2,71	NCF 2217
	3	-	2,5	-	7,4	NJG 2317
90	1,1	1	1	1	0,84	NCF 2918
	1,5	1	1,5	1	1,95	NCF 3018
	2	-	2	-	3,46	NCF 2218
	3	-	2,5	-	8,75	NJG 2318
95	2,1	-	2	-	4,17	NCF 2219
100	1,1	1	1	1	1,15	NCF 2920

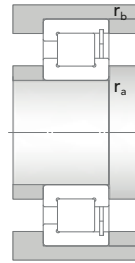
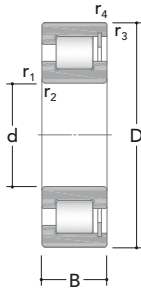

NCF (SL18)

Main dimensions			Basic load ratings		Fatigue load limit	Speed ratings		Designation
d	D	B	Dynamic C	Static C ₀	C _u	Reference	Limiting	Standard design
[mm]			[kN]			[rpm]		
100 (cont.)	150	37	212	307	37,1	1900	2300	NCF 3020
	180	46	384	521	62	1700	1700	NCF 2220
	215	73	694	908	107	1100	1300	NJG 2320
110	150	24	132	219	26	1800	2100	NCF 2922
	170	45	275	394	47	1700	2000	NCF 3022
	200	53	442	595	68,9	1430	1600	NCF 2222
	240	80	852	1050	121	1000	1100	NJG 2322
120	165	27	170	290	34,5	1700	1900	NCF 2924
	180	46	294	436	52	1600	1800	NCF 3024
	215	58	513	729	84	1300	1500	NCF 2224
	260	86	957	1230	138	1000	1100	NJG 2324
130	180	30	207	360	40,5	1500	1800	NCF 2926
	200	52	417	618	72	1400	1630	NCF 3026
	230	64	611	868	97	1300	1400	NCF 2226
	280	93	1075	1410	154	900	1100	NJG 2326
140	190	30	219	390	43	1400	1700	NCF 2928
	210	53	445	679	78	1300	1600	NCF 3028
	250	68	690	1000	112	1100	1300	NCF 2228
	300	102	1241	1655	179	800	1000	NJG 2328
150	190	20	108	199	19,2	1330	1700	NCF 1830
	190	24	147	282	30	1330	1600	NCF 2830
	210	36	289	486	55	1300	1500	NCF 2930
	225	56	454	709	80	1200	1500	NCF 3030
	270	73	774	1209	131	1000	1100	NCF 2230
	320	108	1445	1938	197	800	900	NJG 2330
160	200	20	110	210	20	1300	1540	NCF 1832
	200	24	148	301	30,1	1300	1400	NCF 2832

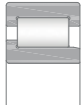

NJG (SL19)

Dimensions					Mass	Designation
d	r _{1,2min}	r _{3,4min}	r _{amax}	r _{bmax}		Standard design
[mm]					[kg]	
100	1,5	1	1,5	1	2,15	NCF 3020
(cont.)	2,1	2,1	2	2	5,1	NCF 2220
	3	-	2,5	-	13	NJG 2320
110	1,1	1	1	1	1,25	NCF 2922
	2	1	2	1	3,5	NCF 3022
	2,1	2,1	2	2	7,15	NCF 2222
	3	-	2,5	-	17,5	NJG 2322
120	1,1	1	1	1	1,75	NCF 2924
	2	1	2	1	3,8	NCF 3024
	2,1	2,1	2	2	9,05	NCF 2224
	3	-	2,5	-	22,5	NJG 2324
130	1,5	1,1	1,5	1	2,35	NCF 2926
	2	1	2	1	5,8	NCF 3026
	3	3	2,5	2,5	11	NCF 2226
	4	-	3	-	28	NJG 2326
140	1,5	1,1	1,5	1	2,4	NCF 2928
	2	1	2	1	6,1	NCF 3028
	3	3	2,5	2,5	14,5	NCF 2228
	4	-	3	-	35,5	NJG 2328
150	1,1	1	1	1	1,3	NCF 1830
	1,1	1	1	1	1,7	NCF 2830
	2	1,1	2	1	3,75	NCF 2930
	2,1	1,1	2	1	7,5	NCF 3030
	3	3	2,5	2,5	18,5	NCF 2230
	4	-	3	-	42,5	NJG 2330
160	1,1	1	1	1	1,45	NCF 1832
	1,1	1	1	1	1,65	NCF 2832

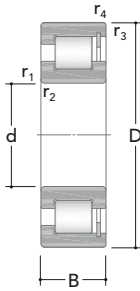

NCF (SL18)

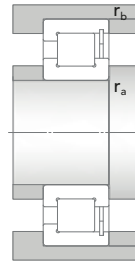

Main dimensions			Basic load ratings		Fatigue load limit C_u	Speed ratings		Designation
d	D	B	Dynamic C	Static C_0		Reference	Limiting	Standard design
[mm]			[kN]			[rpm]		
160 (cont.)	220	36	297	524	57,8	1200	1400	NCF 2932
	240	60	510	784	88	1100	1300	NCF 3032
	290	80	993	1480	158	900	1030	NCF 2232
170	215	27	195	376	40	1200	1400	NCF 2834
	230	36	312	553	59	1100	1300	NCF 2934
	240	30	276	439	46,4	1100	1200	316900
	260	67	661	1040	116	1000	1200	NCF 3034
	310	86	1091	1685	174	900	1000	NCF 2234
	360	120	1773	2420	233	700	800	NJG 2334
180	225	22	145	271	27	1100	1300	NCF 1836
	225	27	198	397	40,7	1100	1300	NCF 2836
	250	42	397	682	74	1000	1200	NCF 2936
	280	74	787	1266	136	1000	1100	NCF 3036
	320	86	1132	1767	184	900	900	NCF 2236
	380	126	1849	2620	252	600	700	NJG 2336
190	240	24	173	315	31	1000	1200	NCF 1838
	240	30	229	461	46,1	1000	1200	NCF 2838
	260	42	436	779	81,4	1000	1200	NCF 2938
	290	75	800	1270	138	1000	1100	NCF 3038
	340	92	1263	1920	198	710	900	NCF 2238
	400	132	2186	2990	279	600	700	NJG 2338
200	250	24	178	330	32	1000	1200	NCF 1840
	250	30	230	473	47	1000	1200	NCF 2840
	280	48	521	950	98	1000	1100	NCF 2940
	310	82	923	1500	157	900	1050	NCF 3040
	360	98	1386	2230	223	800	800	NCF 2240
	420	138	2258	3190	289	600	700	NJG 2340
220	270	24	184	362	34,2	1000	1100	NCF 1844

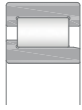

NJG (SL19)

Dimensions					Mass	Designation
d	r _{1,2min}	r _{3,4min}	r _{amax}	r _{bmax}		Standard design
[mm]					[kg]	
160	2	1,1	2	1	4	NCF 2932
(cont.)	2,1	1,1	2	1	9,1	NCF 3032
	3	3	2,5	2,5	23	NCF 2232
170	1,1	1	1	1	2,3	NCF 2834
	2	1,1	2	1	4,3	NCF 2934
	2,7	2,7	2,5	2,5	4,1	316900
	2,1	1,1	2	1	12,5	NCF 3034
	4	4	3	3	28,5	NCF 2234
	4	-	3	-	59,5	NJG 2334
180	1,1	1	1	1	1,95	NCF 1836
	1,1	1	1	1	2,6	NCF 2836
	2	1,1	2	1	6,2	NCF 2936
	2,1	2,1	2	2	16,5	NCF 3036
	4	4	3	3	29,5	NCF 2236
	4	-	3	-	69,5	NJG 2336
190	1,5	1,1	1,5	1	2,45	NCF 1838
	1,5	1,1	1,5	1	3,1	NCF 2838
	2	1,1	2	1	6,5	NCF 2938
	2,1	2,1	2	2	17	NCF 3038
	4	4	3	3	36	NCF 2238
	5	-	4	-	80	NJG 2338
200	1,5	1,1	1,5	1	2,6	NCF 1840
	1,5	1,1	1,5	1	2,6	NCF 2840
	2,1	1,5	2	1,5	9,1	NCF 2940
	2,1	2,1	2	2	22,5	NCF 3040
	4	4	3	3	43,5	NCF 2240
	5	-	4	-	92	NJG 2340
220	1,5	1,1	1,5	1	2,85	NCF 1844

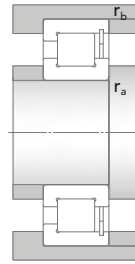
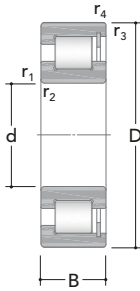

NCF (SL18)

Main dimensions			Basic load ratings		Fatigue load limit C_u	Speed ratings		Designation
d	D	B	Dynamic C	Static C_0		Reference	Limiting	Standard design
[mm]			[kN]			[rpm]		
220 (cont.)	270	30	244	523	50	900	1100	NCF 2844
	300	48	552	1040	104	900	1100	NCF 2944
	340	90	1087	1770	183	800	950	NCF 3044
	400	108	1832	2780	258	700	730	NCF 2244
	460	145	2709	3700	331	500	600	NJG 2344
240	300	28	259	502	46,8	900	1000	NCF 1848
	300	36	339	709	68,4	800	1000	NCF 2848
	320	48	584	1130	113	800	900	NCF 2948
	360	92	1146	1950	199	800	900	NCF 3048
	500	155	3115	4427	392	500	540	NJG 2348
260	320	28	273	548	50	800	900	NCF 1852
	320	36	354	778	73,3	730	900	NCF 2852
	360	60	729	1410	141	700	900	NCF 2952
	400	104	1529	2530	248	700	800	NCF 3052
260	540	165	3583	4970	427	400	500	NJG 2352
	540	206	4313	6240	535	300	440	NCF 3352
280	350	33	345	695	64	700	840	NCF 1856
	350	42	443	984	92	700	810	NCF 2856
	380	60	867	1720	165	700	800	NCF 2956
	420	106	1568	2620	257	700	750	NCF 3056
300	380	38	413	849	75	600	800	NCF 1860
	380	48	565	1230	114	600	800	NCF 2860
	420	72	1106	2208	209	600	700	NCF 2960
	460	118	1907	3190	294	600	700	NCF 3060
320	400	38	436	890	79	600	700	NCF 1864
	400	48	575	1300	118	600	700	NCF 2864
	440	72	1125	2320	216	600	650	NCF 2964
	480	121	1973	3420	307	500	600	NCF 3064

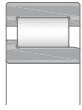

NJG (SL19)

Dimensions					Mass	Designation
d	r _{1,2min}	r _{3,4min}	r _{amax}	r _{bmax}		Standard design
[mm]					[kg]	
220	1,5	1,1	1,5	1	3,9	NCF 2844
(cont.)	2,1	1,5	2	1,5	9,9	NCF 2944
	3	3	2,5	2,5	29,5	NCF 3044
	4	4	3	3	58	NCF 2244
	5	-	4	-	111	NJG 2344
240	2	1,1	2	1	4,4	NCF 1848
	2	1,1	2	1	5,7	NCF 2848
	2,1	1,5	2	1,5	10,5	NCF 2948
	3	3	2,5	2,5	32	NCF 3048
	5	-	4	-	147	NJG 2348
260	2	1,1	2	1	4,75	NCF 1852
	2	1,1	2	1	6,2	NCF 2852
	2,1	1,5	2	1,5	18,5	NCF 2952
	4	4	3	3	46,5	NCF 3052
260	6	-	5	-	177	NJG 2352
	6	6	5	5	220	NCF 3352
280	2	1,1	2	1	7,1	NCF 1856
	2	1,1	2	1	9	NCF 2856
	2,1	1,5	2	1,5	19,5	NCF 2956
	4	4	3	3	50	NCF 3056
300	2,1	1,5	2	1,5	10	NCF 1860
	2,1	1,5	2	1,5	12	NCF 2860
	3	3	2,5	2,5	31	NCF 2960
	4	4	3	3	69	NCF 3060
320	2,1	1,5	2	1,5	10,5	NCF 1864
	2,1	1,5	2	1,5	13,5	NCF 2864
	3	3	2,5	2,5	33	NCF 2964
	4	4	3	3	74,5	NCF 3064

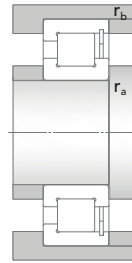
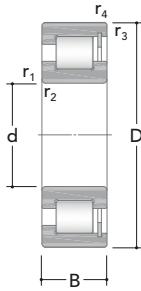

NCF (SL18)

Main dimensions			Basic load ratings		Fatigue load limit C_u	Speed ratings		Designation
d	D	B	Dynamic C	Static C_0		Reference	Limiting	Standard design
[mm]			[kN]			[rpm]		
340	420	38	449	947	83	600	650	NCF 1868
	460	72	1192	2470	225	500	610	NCF 2968
	520	133	2377	4100	351	500	570	NCF 3068
360	440	38	405	883	75,1	500	610	NCF 1872
	440	48	629	1440	127	500	610	NCF 2872
	480	72	1231	2570	237	500	600	NCF 2972
	540	134	2397	4220	358	500	600	NCF 3072
380	480	46	632	1270	112	500	600	NCF 1876
	480	60	893	2050	183	500	600	NCF 2876
	520	82	1556	3190	294	500	600	NCF 2976
	560	135	2708	5040	420	500	520	NCF 3076
400	500	46	622	1320	116	500	550	NCF 1880
	500	60	917	2130	187	450	540	NCF 2880
	540	82	1664	3432	308	500	530	NCF 2980
	600	148	2951	5450	446	400	500	NCF 3080
420	520	46	661	1444	123	500	510	NCF 1884
	520	60	940	2250	197	430	530	NCF 2884
	560	82	1629	3530	309	400	500	NCF 2984
	620	150	3019	5690	454	400	500	NCF 3084
440	540	46	672	1477	126	400	500	NCF 1888
	540	60	1059	2690	231	400	500	NCF 2888
	600	95	2024	4411	381	400	500	NCF 2988
	650	157	3685	7250	562	400	440	NCF 3088
460	580	56	925	1950	159	400	500	NCF 1892
	580	72	1288	3010	257	400	500	NCF 2892
	620	95	2070	4480	388	400	440	NCF 2992
	680	163	3686	6840	531	400	430	NCF 3092

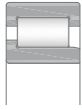

NJG (SL19)

Dimensions					Mass	Designation
d	r _{1,2min}	r _{3,4min}	r _{amax}	r _{bmax}		Standard design
[mm]					[kg]	
340	2,1	1,5	2	1,5	11	NCF 1868
	3	3	2,5	2,5	35	NCF 2968
	5	5	4	4	100	NCF 3068
360	2,1	1,5	2	1,5	11,5	NCF 1872
	2,1	1,5	2	1,5	15	NCF 2872
	3	3	2,5	2,5	36,5	NCF 2972
	5	5	4	4	105	NCF 3072
380	2,1	1,5	2	1,5	19,5	NCF 1876
	2,1	1,5	2	1,5	25	NCF 2876
	4	4	3	3	52	NCF 2976
	5	5	4	4	110	NCF 3076
400	2,1	1,5	2	1,5	20,5	NCF 1880
	2,1	1,5	2	1,5	26,5	NCF 2880
	4	4	3	3	54,5	NCF 2980
	5	5	4	4	145	NCF 3080
420	2,1	1,5	2	1,5	20,5	NCF 1884
	2,1	1,5	2	1,5	28	NCF 2884
	4	4	3	3	57	NCF 2984
	5	5	4	4	150	NCF 3084
440	2,1	1,5	2	1,5	22	NCF 1888
	2,1	1,5	2	1,5	30	NCF 2888
	4	4	3	3	80	NCF 2988
	6	6	5	5	175	NCF 3088
460	3	3	2,5	2,5	34	NCF 1892
	3	3	2,5	2,5	44	NCF 2892
	4	4	3	3	83	NCF 2992
	6	6	5	5	195	NCF 3092

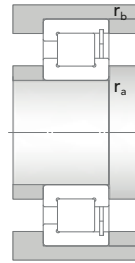
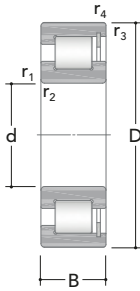

NCF (SL18)

Main dimensions			Basic load ratings		Fatigue load limit C_u	Speed ratings		Designation
d	D	B	Dynamic C	Static C_0		Reference	Limiting	Standard design
[mm]			[kN]			[rpm]		
480	600	56	934	2020	168	400	440	NCF 1896
	600	72	1322	3110	262	400	430	NCF 2896
	650	100	2318	4850	401	400	430	NCF 2996
	700	165	3765	7060	539	340	400	NCF 3096
500	620	56	945	2080	170	400	410	NCF 18/500
	620	72	1334	3330	273	400	410	NCF 28/500
	670	100	2379	5327	432	400	400	NCF 29/500
	720	167	3762	7350	559	340	400	NCF 30/500
530	650	56	994	2230	179	350	400	NCF 18/530
	650	72	1409	3440	284	340	400	NCF 28/530
	710	106	2714	5880	456	330	400	NCF 29/530
	780	185	5221	10560	777	300	400	NCF 30/530
560	680	56	1014	2340	184	300	400	NCF 18/560
	680	72	1418	3580	294	300	400	NCF 28/560
	750	112	2970	6600	483	300	400	NCF 29/560
	820	195	5831	11640	853	300	330	NCF 30/560
600	730	60	1043	2520	194	300	400	NCF 18/600
	730	78	1590	4250	336	300	350	NCF 28/600
	800	118	3360	7548	554	300	340	NCF 29/600
630	780	69	1232	2880	230	300	320	NCF 18/630
	780	88	1967	4930	385	300	310	NCF 28/630
	850	128	3693	8530	602	300	300	NCF 29/630
670	820	69	1281	3140	244	300	300	NCF 18/670
	820	88	1962	5260	412	300	300	NCF 28/670
	900	136	3894	8850	620	250	300	NCF 29/670
710	870	74	1533	3690	280	250	300	NCF 18/710
	870	95	2326	6200	472	250	300	NCF 28/710

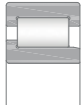

NJG (SL19)

Dimensions					Mass	Designation
d	r _{1,2min}	r _{3,4min}	r _{amax}	r _{bmax}		Standard design
[mm]					[kg]	
480	3	3	2,5	2,5	35,5	NCF 18/96
	3	3	2,5	2,5	46	NCF 28/96
	5	5	4	4	93	NCF 29/96
	6	6	5	5	205	NCF 30/96
500	3	3	2,5	2,5	35,5	NCF 18/500
	3	3	2,5	2,5	48	NCF 28/500
	5	5	4	4	100	NCF 29/500
	6	6	5	5	215	NCF 30/500
530	3	3	2,5	2,5	38,5	NCF 18/530
	3	3	2,5	2,5	49,5	NCF 28/530
	5	5	4	4	120	NCF 29/530
	6	6	5	5	300	NCF 30/530
560	3	3	2,5	2,5	40,5	NCF 18/560
	3	3	2,5	2,5	54	NCF 28/560
	5	5	4	4	140	NCF 29/560
	6	6	5	5	345	NCF 30/560
600	3	3	2,5	2,5	51,5	NCF 18/600
	3	3	2,5	2,5	67,5	NCF 28/600
	5	5	4	4	170	NCF 29/600
630	4	4	3	3	72,5	NCF 18/630
	4	4	3	3	92,5	NCF 28/630
	6	6	5	5	205	NCF 29/630
670	4	4	3	3	76,5	NCF 18/670
	4	4	3	3	98	NCF 28/670
	6	6	5	5	245	NCF 29/670
710	4	4	3	3	92,5	NCF 18/710
	4	4	3	3	115	NCF 28/710

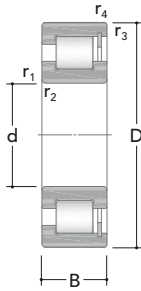

NCF (SL18)

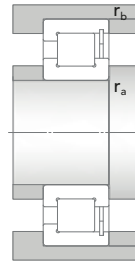

Main dimensions			Basic load ratings		Fatigue load limit C_u	Speed ratings		Designation
d	D	B	Dynamic C	Static C_0		Reference	Limiting	Standard design
[mm]			[kN]			[rpm]		
710	950	140	4303	9920	689	230	300	NCF 29/710
(cont.)								
750	920	78	1790	4410	323	230	300	NCF 18/750
	920	100	2662	6840	512	230	300	NCF 28/750
	1000	145	4425	10580	709	210	250	NCF 29/750
800	980	82	1957	4776	343	210	250	NCF 18/800
	980	106	2743	7450	546	210	240	NCF 28/800
	1060	150	4900	11900	793	190	230	NCF 29/800
850	1030	82	2065	5130	370	190	230	NCF 18/850
	1030	106	2837	7920	564	190	230	NCF 28/850
	1120	155	5271	12630	825	180	210	NCF 29/850
900	1090	85	2259	5660	402	180	210	NCF 18/900
	1090	112	3218	8970	642	180	210	NCF 28/900
	1180	165	6011	14520	945	160	200	NCF 29/900
950	1150	90	2390	6240	421	160	200	NCF 18/950
	1150	118	3402	9670	646	160	200	NCF 28/950
	1250	175	6510	16090	1007	150	200	NCF 29/950
1000	1220	100	2952	7420	450	150	200	NCF 18/1000
	1220	128	4113	11460	711	150	200	NCF 28/1000
	1320	185	7467	18270	1139	140	200	NCF 29/1000
1120	1360	106	3757	9500	576	120	150	NCF 18/1120

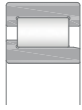

NJG (SL19)

Dimensions					Mass	Designation
d	r _{1,2min}	r _{3,4min}	r _{amax}	r _{bmax}		Standard design
[mm]					[kg]	
710	6	6	5	5	275	NCF 29/710
(cont.)						
750	5	5	4	4	110	NCF 18/750
	5	5	4	4	138	NCF 28/750
	6	6	5	5	315	NCF 29/750
800	5	5	4	4	126	NCF 18/800
	5	5	4	4	165	NCF 28/800
	6	6	5	5	359	NCF 29/800
850	5	5	4	4	131	NCF 18/850
	5	5	4	4	175	NCF 28/850
	6	6	5	5	406	NCF 29/850
900	5	5	4	4	154	NCF 18/900
	5	5	4	4	208	NCF 28/900
	6	6	5	5	472	NCF 29/900
950	5	5	4	4	185	NCF 18/950
	5	5	4	4	240	NCF 28/950
	7,5	7,5	6	6	565	NCF 29/950
1000	6	6	5	5	230	NCF 18/1000
	6	6	5	5	310	NCF 28/1000
	7,5	7,5	6	6	680	NCF 29/1000
1120	6	6	5	5	298	NCF 18/1120

Double row cylindrical roller bearings

With a wide range of executions of double row cylindrical roller bearings, RKB is able to fulfil any requirement in demanding applications such as large size gearboxes, machine tools, grinding mills and crushers.

To ensure superior performance, RKB double row cylindrical roller bearings are manufactured from high quality special steels, heat treated in optimized automatic lines.

With improved internal geometry and profile, double row cylindrical roller bearings can withstand high radial loads within a narrow cross section.

Internal clearance

Generally RKB double row cylindrical roller bearings are manufactured with normal radial clearance CN, but they can also feature C2, C3, C4 or C5 radial clearance in accordance to ISO 5753:2009. The radial internal clearance values are reported in the **Tab. 1 page 127** and **Tab. 2 page 128** and they are valid only for bearing unmounted and unloaded.



Double row cylindrical roller bearings

Axial displacement

NNU and NN bearing can accommodate axial displacement between shaft and housing within certain limits. And can be used as non-locating bearings, supporting radial loads only. As a consequence of the fact that the axial displacement takes between the inner ring and outer ring and not between the inner ring and shaft and outer ring and housing, there is no additional friction during the bearing rotation.

Misalignment

Any misalignment between shaft and seat of the double row cylindrical roller bearing creates a moment load inside the bearing. The bearing life will be obviously affected.

Minimum load

A minimum radial load is requested for a double row cylindrical roller bearings to allow the correct functioning, especially in critical working conditions like: high speed, high acceleration and sudden changes of rotating direction. In these operating conditions, a skidding between the rollers and raceways can be generated by the inertial forces, influencing negatively the bearing life. Minimum radial load can be theoretically estimated using the following formula:

$$F_{rm} > \frac{C_{0r}}{50}$$

Where:

- F_{rm} minimum radial load, [kN];
- C_{0r} basic static load rating, [kN] .

Usually, the minimum radial load is reached or surpassed by the weight of the components supported by the bearing together with the loads acting on it, otherwise supplementary radial load must be applied on the double row cylindrical roller bearing.

Designs and variants

Type NNU

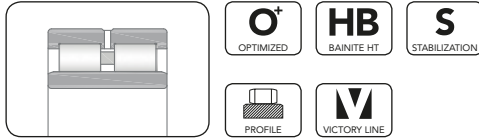

- Outer ring with three integral ribs
- Ribless inner ring
- One-piece double pronged machined brass or steel cage
- Annular groove and lubrication holes in outer ring
- Optimized raceway geometry and roller profile
- Available with cylindrical and tapered bore
- Available with locating slots in outer ring, lubrication holes in inner ring, lubrication grooves in side faces of inner and outer rings
- Available with steel pin-type cage and pierced roller design

Type NNUP

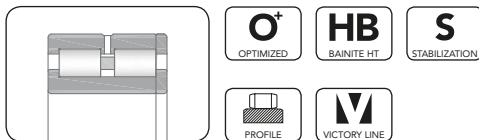

- Outer ring with two integral ribs and one loose rib
- Inner ring with one integral side rib and one loose rib
- One-piece double pronged machined brass or steel cage
- Annular groove and lubrication holes in outer ring
- Optimized raceway geometry and roller profile
- Available with locating slots in outer ring, lubrication holes in inner ring, lubrication grooves in side faces of inner and outer rings
- Available with steel pin-type cage and pierced roller design

Type NNUB

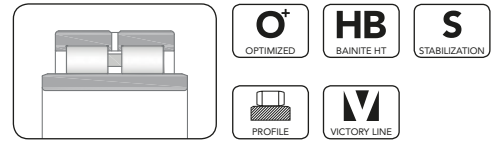

- Outer ring with three integral ribs
- Wider ribless inner ring
- One-piece double pronged machined brass or steel cage
- Annular groove and lubrication holes in outer ring
- Optimized raceway geometry and roller profile
- Available with locating slots in outer ring, lubrication holes in inner ring, lubrication grooves in side faces of inner and outer rings
- Available with steel pin-type cage and pierced roller design

Type NN

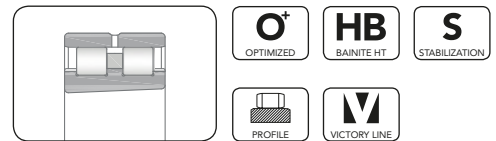

- Ribless outer ring
- Inner ring with three integral ribs
- One-piece double pronged machined brass cage
- Annular groove and lubrication holes in outer ring
- Optimized raceway geometry and roller profile
- Available with tapered and cylindrical bore
- Available with steel pin-type cage and pierced roller design

Split type 2ROW SCRB

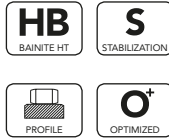
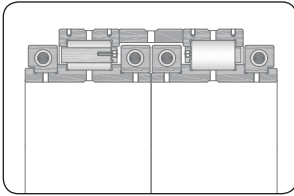

- Design used for medium and large size bearings
- Two wider inner ring with integral side ribs
- Two-piece window type for each bearing row
- Engineered for hard-to-reach positions (e.g. universal joint drive shaft supporting)
- Design for easy mounting, dismounting and maintenance to reduced machine downtime
- Available in locating and non-locating configuration

Prefixes

L	In a separable bearing: separate inner ring
R	In a separable bearing: outer ring with roller and cage assembly
SCRB	Out of standard double row cylindrical roller bearing followed by drawing number
2CRB	Out of standard double row cylindrical roller bearing followed by drawing number

Suffixes

Internal Design

OD	Special outer diameter. The number immediately following the OD gives the outer diameter in mm
B	Special bearing width. The number immediately following the B gives the width in mm
SP	Special or non-standard bearing
ZB	Optimized roller profile for improved load distribution. It is not necessarily stated in the bearing code

Suffixes

Cage

M	Machined brass cage guided on rolling elements
MA	Machined brass cage guided on outer ring
MF	Machined steel cage
AVH	Machined brass cage with round or square integral rivets guided on outer ring (MA), inner ring (MB) or rollers (M)

Suffixes

Lubrication

G	Helical groove in inner ring bore (not necessarily stated)
ISR3	Annular groove and three lubrication holes in inner ring
W33	Annular groove and three lubrication holes in outer ring
W33X	Annular groove and more than three lubrication holes in outer ring
W77X	Annular groove and more than three plugged lubrication holes in outer ring
W	Lubrication grooves in the side faces of inner and outer rings (not necessarily stated)
WI	Lubrication grooves in the side face of inner ring (not necessarily stated)
WO	Lubrication grooves in the side face of outer ring (not necessarily stated)

Suffixes

External design

K	Tapered bore, taper 1:12
K30	Tapered bore, taper 1:30

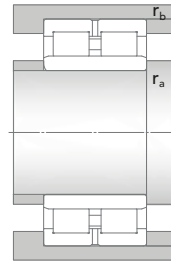
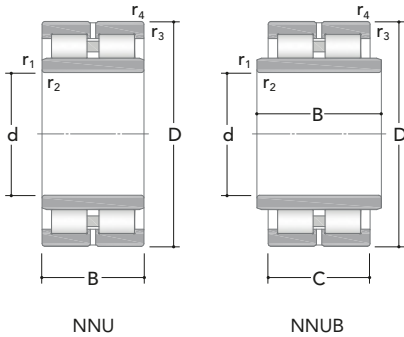

Main dimensions				Basic load ratings		Fatigue	Speed ratings	Designation
d	D	B	C	Dynamic C	Static C ₀	load limit C _u	Reference	Standard design
[mm]				[kN]			[rpm]	
100	140	40	-	126	252	29	6700	NNU 4920
	140	70	40	128	253	29	5100	NNUB 315033
	140	80	40	128	251	29	5100	NNUB 319114
	150	37	-	152	248	29	6400	NN 3020
	165	65	-	356	563	70	3800	NNU 4120
105	145	40	-	130	258	29	6400	NNU 4921
	160	41	-	191	303	36	5900	NN 3021
	175	69	-	415	668	80	3600	NNU 4121
110	150	40	-	130	268	30	6300	NNU 4922
	170	45	-	220	359	41,4	5600	NN 3022
	180	69	-	423	702	82	3400	NNU 4122
120	165	45	-	176	339	37,4	5600	NNU 4924
	165	45	-	201	373	43	4200	319826
	180	46	-	228	389	44	5300	NN 3024
	200	80	-	518	861	100	3200	NNU 4124
	215	130	100	705	1110	129	2300	NNUB 322978
127	174,65	75,41	-	315	651	76	3800	315643
130	180	50	-	186	383	40,8	5100	NNU 4926
	200	52	-	287	467	52	4800	NN 3026
	210	80	-	553	955	109	3000	NNU 4126
140	190	50	-	192	395	41	4800	NNU 4928
	210	53	-	294	517	56	4600	NN 3028
	225	85	-	634	1030	117	2800	NNU 4128
150	190	40	-	192	445	42	4800	NN 4830
	210	60	-	331	647	70	4600	NNU 4930
	225	56	-	334	566	62	4200	NN 3030

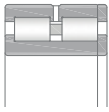

NNUP

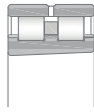

NN

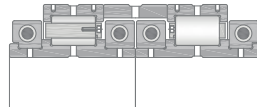

2ROW SCRBB

Dimensions					Mass	Designation	
d	r _{1,2min}	r _{3,4min}	r _{amax}	r _{bmax}		Cylindrical bore	Tapered bore
[mm]					[kg]		
100	1,1	1,1	1	1	1,9	NNU 4920	NNU 4920 K
	1,1	1,1	1	1	2,5	NNUB 315033	-
	1,1	1,1	1	1	2,65	NNUB 319114	-
	1,5	1,5	1,5	1,5	2,2	NN 3020	NN 3020 K
	1,1	2	1	2	5,5	NNU 4120	NNU 4120 K30
105	1,1	1,1	1	1	2	NNU 4921	NNU 4921 K
	2	2	2	2	2,8	NN 3021	NN 3021 K
	1,1	2	1	2	6,7	NNU 4121	NNU 4121 K30
110	1,1	1,1	1	1	2,05	NNU 4922	NNU 4922 K
	2	2	2	2	3,55	NN 3022	NN 3022 K
	1,1	2	1	2	6,95	NNU 4122	NNU 4122 K30
120	1,1	1,1	1	1	2,8	NNU 4924	NNU 4924 K
	1	1	1	1	2,8	319826	-
	2	2	2	2	3,85	NN 3024	NN 3024 K
	1,1	2	1	2	11	NNU 4124	NNU 4124 K30
	2x60°	1,1	2	1	15,5	NNUB 322978	-
127	1,1	1,5	1	1,5	5,3	315643	-
130	1,5	1,5	1,5	1,5	3,85	NNU 4926	NNU 4926 K
	1,1	2	2	2	5,75	NN 3026	NN 3026 K
	2	1,1	1	2	10,5	NNU 4126	NNU 4126 K30
140	1,5	1,5	1,5	1,5	4,1	NNU 4928	NNU 4928 K
	2	2	2	2	6,2	NN 3028	NN 3028 K
	2,1	2,1	2	2	13	NNU 4128	NNU 4128 K30
150	1,1	1,1	1	1	2,75	NN 4830	NN 4830 K
	2	2	2	2	6,25	NNU 4930	NNU 4930 K
	2,1	2,1	2	2	7,5	NN 3030	NN 3030 K

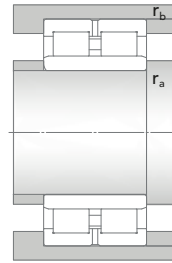
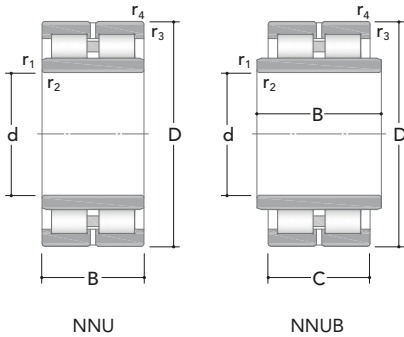

Main dimensions				Basic load ratings		Fatigue	Speed ratings	Designation
d	D	B	C	Dynamic C	Static C ₀	load limit C _u	Reference	Standard design
[mm]				[kN]			[rpm]	
150	250	100	-	748	1270	141	2500	NNU 4130
(cont.)								
155	220	60	-	330	676	72	3200	314781
160	220	60	-	328	673	71	4200	NNU 4932
	240	60	-	371	650	69	4000	NN 3032
	265	120	-	1009	1770	190	2300	320160
	270	109	-	945	1510	164	2300	NNU 4132
165,1	225,45	84,15	-	507	1100	118	2960	315642
170	230	60	-	338	682	72,1	4000	NNU 4934
	230	80	-	554	1170	126	3000	322340
	260	67	-	457	802	84	3600	NN 3034
	260	115	112,5	827	1630	173	2500	NNUB 320687
	280	109	-	957	1600	170	2100	NNU 4134
180	250	69	-	401	842	87	3600	NNU 4936
	280	74	-	568	995	101	3400	NN 3036
	300	118	-	1077	1820	189	2000	NNU 4136
190	260	69	-	394	879	90	3400	NNU 4938
	290	75	-	594	1070	107	3200	NN3038
	320	128	-	1337	2160	224	1900	NNU 4138
200	250	50	-	246	593	49	2500	NNU 4840
	280	80	-	480	1020	104	3200	NNU 4940
	310	82	-	637	1120	116	3000	NN 3040
	310	115	-	1003	1830	190	2100	313639
	333,98	174,6	-	1808	2791	274	1800	322185
	340	140	-	1458	2520	257	1800	NNU 4140
210	320	195	115	1018	2050	209	2000	NNUB 322459

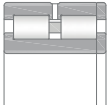

NNUP

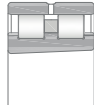

NN

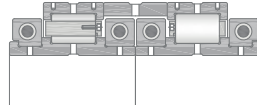

2ROW SCR

Dimensions					Mass	Designation	
d	r _{1,2min}	r _{3,4min}	r _{amax}	r _{bmax}		Cylindrical bore	Tapered bore
[mm]					[kg]		
150	2,1	2,1	2	2	18	NNU 4130	NNU 4130 K30
(cont.)							
155	1	2	1	2	7,6	-	314781 K
160	2	2	2	2	6,6	NNU 4932	NNU 4932 K
	2,1	2,1	2	2	9,1	-	NN 3032 K
	3	3	2,5	2,5	27	320160	-
	2,1	2,1	2	2	25	NNU 4132	NNU 4132 K30
165,1	1,5	1,5	1,5	1,5	10	315642	-
170	2	2	2	2	6,95	NNU 4934	NNU 4934 K
	2	2	2	2	9,55	322340	-
	2,1	2,1	2	2	12,5	-	NN 3034 K
	2,1	2,1	2	2	22	NNUB 320687	-
	2,1	2,1	2	2	26	NNU 4134	NNU 4134 K30
180	2	2	2	2	10,5	NNU 4936	NNU 4936 K
	2,1	2,1	2	2	16,5	-	NN 3036 K
	3	3	2,5	2,5	32,5	NNU 4136	NNU 4136 K30
190	2	2	2	2	11	NNU 4938	NNU 4938 K
	2,1	2,1	2	2	17	-	NN 3038 K
	3	3	2,5	2,5	41	NNU 4138	NNU 4138 K30
200	1,1	1,5	1	1,5	5,75	NNU 4840	NNU 4840 K
	2,1	2,1	2	2	15	NNU 4940	NNU 4940 K
	2,1	2,1	2	2	22	-	NN 3040 K
	2,1	2,1	2	2	31,5	313639	-
	7x45°	7x45°	7	7	69,5	322185	-
	3	3	2,5	2,5	51	NNU 4140	NNU 4140 K30
210	2,1	2,1	2	2	40,5	NNUB 322459	-

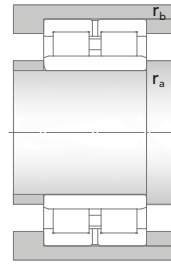
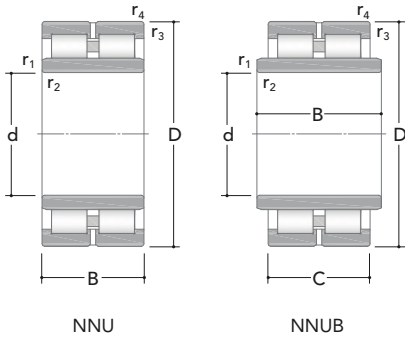

Main dimensions				Basic load ratings		Fatigue	Speed ratings	Designation
d	D	B	C	Dynamic C	Static C ₀	load limit C _u	Reference	Standard design
[mm]				[kN]			[rpm]	
220 (cont.)	300	80	-	519	1120	112	3000	NNU 4944
	300	100	-	890	1941	194	2300	322341
	330	115	-	1012	1930	197	1900	314889
	340	90	-	806	1440	141	2800	NN 3044
	370	150	-	1665	2890	284	1600	NNU 4144
240	300	60	-	363	924	81	2300	NNU 4848
	320	80	-	526	1210	117	2800	NNU 4948
	320	100	-	868	1950	192	1500	326257
	360	92	-	847	1540	151	2500	NN 3048
	400	160	-	1960	3580	348	1500	NNU 4148
260	360	100	-	747	1680	161	2500	NNU 4952
	360	102	-	981	2190	211	1900	314997
	370	110	-	1172	2320	228	1800	316028
	400	104	-	1028	1943	184	2300	NN 3052
	400	140	-	1641	3100	300	1600	NNU 4052
	440	180	-	2195	3870	362	1400	NNU 4152
	480	260	-	3184	5830	508	1100	313621
280	350	69	-	457	1197	100	1800	NNU 4856
	380	100	-	768	1808	171	2300	NNU 4956
	380	100	-	768	1808	171	2300	NNUP 4956
	400	142,5	-	1553	3710	351	1500	314070
	410	150	-	1759	3740	364	1500	314897
	420	106	-	1081	2040	192	2100	NN 3056
	420	140	-	1670	3090	299	1500	NNU 4056
	460	180	-	2587	4670	433	1300	NNU 4156
	470	200	-	2934	5550	515	1100	315976
	300	380	80	-	580	1540	127	1700
420		118	-	1009	2330	221	2100	NNU 4960
420		150	-	1886	4420	417	1700	326805

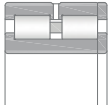

NNUP

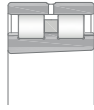

NN

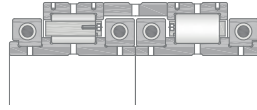

2ROW SCRBB

Dimensions					Mass	Designation	
d	r _{1,2min}	r _{3,4min}	r _{amax}	r _{bmax}		Cylindrical bore	Tapered bore
[mm]					[kg]		
220 (cont.)	2,1	2,1	2	2	16,5	NNU 4944	NNU 4944 K
	2,1	2,1	2	2	20,5	322341	-
	2,1	2,1	2	2	34,5	314889	-
	3	3	2,5	2,5	28,5	-	NN 3044 K
	4	4	3	3	65	NNU 4144	NNU 4144 K30
240	1,1	2	1	2	9,9	NNU 4848	NNU 4848 K
	2,1	2,1	2	2	17,5	NNU 4948	NNU 4948 K
	2,1	2,1	2	2	22,5	326257	-
	3	3	2,5	2,5	32	NN 3048	NN 3048 K
	4	4	3	3	85	NNU 4148	NNU 4148 K30
260	2,1	2,1	2	2	30,5	NNU 4952	NNU 4952 K
	9x20°	2,1	-	2	32	314997	-
	3	3	2	2	38,5	316028	-
	4	4	3	3	46	-	NN 3052 K
	4	4	3	3	63,5	NNU 4052	NNU 4052 K
	4	4	3	3	110	NNU 4152	NNU 4152 K30
	5	5	4	4	205	313621	-
280	1,1	2	1	2	15,5	NNU 4856	NNU 4856 K
	2,1	2,1	2	2	32,5	NNU 4956	NNU 4956 K
	2,1	2,1	2	2	33,5	NNUP 4956	-
	3	3	2,5	2,5	60	314070	-
	4	4	3	3	61	314897	-
	4	4	3	3	49,5	-	NN 3056 K
	4	4	3	3	66,5	NNU 4056	NNU 4056 K
	5	5	4	4	120	NNU 4156	NNU 4156 K30
	3	5	2,5	4	150	315976	-
300	1,5	2,1	1,5	2	22	NNU 4860	NNU 4860 K
	3	3	2,5	2,5	50	NNU 4960	NNU 4960 K
	6,4x20°	1,5	6	1,5	55,5	326805	-

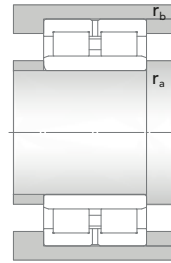
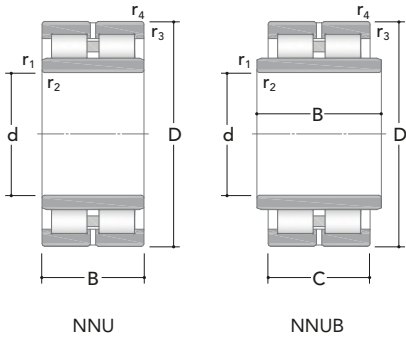

Main dimensions				Basic load ratings		Fatigue	Speed ratings	Designation
d	D	B	C	Dynamic C	Static C ₀	load limit C _u	Reference	Standard design
[mm]				[kN]			[rpm]	
300 (cont.)	460	118	-	1247	2360	224	2000	NN 3060
	460	160	-	2025	3990	374	1400	NNU 4060
	460	180	-	2569	5430	484	1100	320119
	500	200	-	2881	5270	452	1200	NNU 4160
320	400	80	-	771	2050	171	1600	NNU 4864
	440	118	-	1070	2450	237	2000	NNU 4964
	440	118	-	1070	2450	237	2000	NNUP 4964
	460	120	-	1741	3590	334	1000	322216
	480	121	-	1303	2550	235	1900	NN 3064
	480	160	-	2107	4290	399	1300	NNU 4064
	480	175	-	2486	5336	504	1000	315583
	540	218	-	3404	6170	527	1100	NNU 4164
340	420	80	-	642	1800	141	1480	NNU 4868
	420	80	-	642	1800	141	1480	NNUP 4868
	460	118	-	1112	2610	241	1810	NNU 4968
	520	133	-	1629	3190	285	1690	NN 3068
	520	180	-	2528	5070	452	1170	NNU 4068
	520	305	200	3287	7060	607	950	NNUB 320118
	580	243	-	4020	7390	611	1010	NNU 4168
	350	500	190	-	2482	5600	511	1000
520		150	-	2116	4470	397	900	319878
355,59	558,8	279,4	-	4400	8330	706	1000	322186
							900	
360	480	118	-	1120	2770	247	1800	NNU 4972
	500	125	-	1787	3635	334	1270	320075
	500	125	-	2080	4280	358	1000	322217
	510	190	-	2573	6020	543	950	320299
	540	134	-	1721	3420	307	1590	NN 3072
	540	180	-	2815	5660	506	1170	NNU 4072

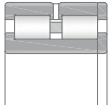

NNUP

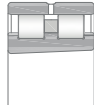

NN

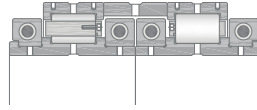

2ROW SCRBB

Dimensions					Mass	Designation	
d	r _{1,2min}	r _{3,4min}	r _{amax}	r _{bmax}		Cylindrical bore	Tapered bore
[mm]					[kg]		
300	4	4	3	3	68,5	-	NN 3060 K
(cont.)	4	4	3	3	96	NNU 4060	NNU 4060 K
	4	4	3	3	118	320119	-
	5	5	4	4	155	NNU 4160	NNU 4160 K30
320	1,5	2,1	1,5	2	23,5	NNU 4864	NNU 4864 K
	3	3	2,5	2,5	53	NNU 4964	NNU 4964 K
	3	3	2,5	2,5	55,5	NNUP 4964	-
	3	3	2,5	2,5	70	322216	-
	4	4	3	3	74	-	NN 3064 K
	4	4	3	3	100	NNU 4064	NNU 4064 K
	4	1,5	3	1,5	115	315583	-
	5	5	4	4	200	NNU 4164	NNU 4164 K30
340	1,5	2,1	1,5	2	25	NNU 4868	NNU 4868 K
	2,1	2,1	2	2	24,5	NNUP 4868	-
	3	3	2,5	2,5	56	NNU 4968	NNU 4968 K
	5	5	4	4	97,5	-	NN 3068 K
	5	5	4	4	140	NNU 4068	NNU 4068 K
	5	5	4	4	185	NNUB 320118	-
	5	5	4	4	260	NNU 4168	NNU 4168 K30
350	5	5	4	4	115	314563	-
	5	5	4	4	110	319878	-
355,59	10,5x45°	3x45°	10	3	270	322186	-
360	3	3	2,5	2,5	58,5	NNU 4972	NNU 4972 K
	3	3	2,5	2,5	72	320075	-
	3	3	2,5	2,5	80	322217	-
	5	5	4	4	120	320299	-
	5	5	4	4	105	-	NN 3072 K
	5	5	4	4	140	NNU 4072	NNU 4072 K

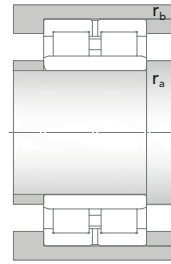
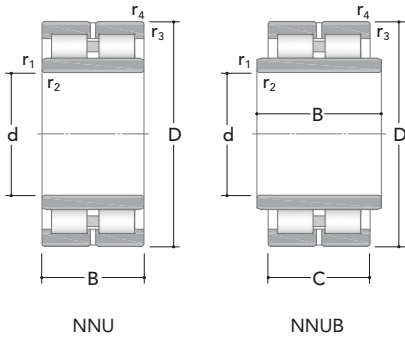

Main dimensions				Basic load ratings		Fatigue load limit	Speed ratings	Designation
d	D	B	C	Dynamic C	Static C ₀	C _u	Reference	Standard design
[mm]				[kN]			[rpm]	
360	600	243	-	4239	8420	688	950	NNU 4172
(cont.)								
370	520	220	193	2762	6680	568	900	NNUB 319961
380	480	100	-	945	2530	210	1300	NNU 4876
	520	140	-	1456	3530	208	1300	NNU 4976
	540	130	-	2034	4270	377	900	326131
	540	150	-	2533	5450	476	900	316062
	540	200	-	3141	6890	593	800	320041
	560	135	-	1699	3410	301	1600	NN 3076
	560	180	-	2894	5940	525	1100	NNU 4076
	620	243	-	4320	8380	670	900	NNU 4176
400	500	100	-	961	2733	207	1200	NNU 4880
	500	100	-	961	2733	207	1200	NNUP 4880
	540	140	-	1679	4479	331	1600	NNU 4980
	560	205	-	3179	7740	650	800	314987
	590	220	-	3650	8190	686	800	315802
	600	148	-	2129	4450	376	1500	NN 3080
	600	200	-	3503	7060	588	1000	NNU 4080
	600,19	200	-	3477	7130	594	1000	326880
	600,19	200	-	3492	7120	593	800	326363
	650	250	-	4720	9340	737	800	NNU 4180
406,4	647,7	342,8	-	6355	12290	983	800	322187
410	600	140	-	3829	8570	713	800	316019
420	520	100	-	997	2810	193	1200	NNU 4884
	560	140	-	1523	3980	343	1500	NNU 4984
	580	130	-	2306	4710	407	1100	320074
	580	130	-	2522	5280	463	800	326137
	580	160	-	2316	5300	466	900	313555

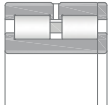

NNUP

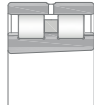

NN

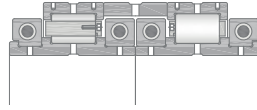

2ROW SCR

Dimensions					Mass	Designation	
d	r _{1,2min}	r _{3,4min}	r _{amax}	r _{bmax}		Cylindrical bore	Tapered bore
[mm]					[kg]		
360	5	5	4	4	275	NNU 4172	NNU 4172 K30
(cont.)							
370	13,7x20°	1,5	-	1,5	130	NNUB 319961	-
380	1,5	2,1	1,5	2	44	NNU 4876	NNU 4876 K
	4	4	3	3	87,5	NNU 4976	NNU 4976 K
	4	4	3	3	100	326131	-
	8,5x20°	2	-	2	110	316062	-
	5	2	4	2	145	320041	-
	5	5	4	4	110	-	NN 3076 K
	5	5	4	4	150	NNU 4076	NNU 4076 K
	5	5	4	4	285	NNU 4176	NNU 4176 K30
400	1,5	2,1	1,5	2	46	NNU 4880	NNU 4880 K
	2,1	2,1	2	2	45,5	NNUP 4880	-
	4	4	3	3	91,5	NNU 4980	NNU 4980 K
	5	2	4	2	160	314987	-
	5	5	4	4	210	315802	-
	5	5	4	4	140	-	NN 3080 K
	5	5	4	4	205	NNU 4080	NNU 4080 K
	5	5	4	4	200	326880	-
	5	5	4	4	205	326363	-
	6	6	5	5	325	NNU 4180	NNU 4180 K30
406,4	13x45°	5x45°	12	5	435	322187	-
410	5	5	4	4	215	316019	-
420	1,5	2,1	1,5	2	48	NNU 4884	NNU 4884 K
	4	4	3	3	95,5	NNU 4984	NNU 4984 K
	4	4	3	3	110	320074	-
	4	4	3	3	110	326137	-
	4	4	3	3	125	313555	-

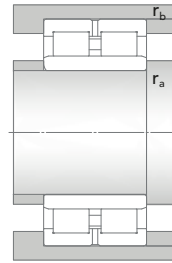
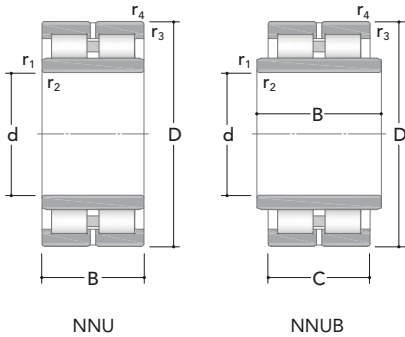

Main dimensions				Basic load ratings		Fatigue	Speed ratings	Designation
d	D	B	C	Dynamic C	Static C ₀	load limit C _u	Reference	Standard design
[mm]				[kN]			[rpm]	
420	600	220	-	3609	8710	713	800	314982
(cont.)	620	150	-	2122	4480	378	1400	NN 3084
	620	200	-	3508	7460	607	1000	NNU 4084
	620	200	-	3494	7660	643	700	314391
	620	260	-	4340	10080	870	900	614844
	700	280	-	5457	11310	893	800	NNU 4184
440	540	100	-	1016	3399	216	1100	NNU 4888
	600	160	-	2072	5120	443	1400	NNU 4988
	620	225	-	3870	9670	789	700	316077
	640	230	-	4596	9790	779	900	316521
	650	157	-	2426	5020	418	1300	NN 3088
	650	212	-	3920	8250	666	900	NNU 4088
	720	280	-	5768	11660	889	700	NNU 4188
457,2	660,4	228,6	203,2	3651	7990	627	700	NNUB 322969
460	580	118	-	1199	3190	220	1100	NNU 4892
	620	160	-	2111	5390	456	1300	NNU 4992
	650	235	-	4429	11040	887	700	316739
	680	163	-	2585	5410	448	1300	NN 3092
	680	218	-	4267	8860	709	800	NNU 4092
	760	300	-	6496	13020	989	700	NNU 4192
480	650	170	-	2349	6010	502	1300	NNU 4996
	700	165	-	2668	5790	475	1200	NN 3096
	700	218	-	4353	9490	738	800	NNU 4096
	700	260	-	5352	12380	941	600	316189
	790	308	-	7090	14090	1064	700	NNU 4196
487,98	637	175	-	3040	7530	6044	700	326196
490	694	174	-	3733	8890	741	700	316639

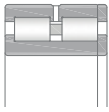

NNUP

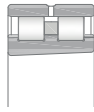

NN

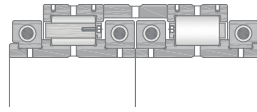

2ROW SCRBB

Dimensions					Mass	Designation	
d	r _{1,2min}	r _{3,4min}	r _{amax}	r _{bmax}		Cylindrical bore	Tapered bore
[mm]					[kg]		
420	2	2	2	2	205	314982	-
(cont.)	5	5	4	4	145	-	NN 3084 K
	5	5	4	4	183	NNU 4084	NNU 4084 K
	4	4	3	3	220	314391	-
	6	6	5	5	280	614844	-
	6	6	5	5	440	NNU 4184	NNU 4184 K30
440	1,5	2,1	1,5	2	50	NNU 4888	NNU 4888 K
	4	4	3	3	130	NNU 4988	NNU 4988 K
	12x20°	2	-	2	220	316077	-
	6	6	5	5	250	316521	-
	6	6	5	5	170	-	NN 3088 K
	6	6	5	5	215	NNU 4088	NNU 4088 K
	6	6	5	5	450	NNU 4188	NNU 4188 K30
457,2	6	6	5	5	235	NNUB 322969	-
460	3	3	2,5	2,5	75	NNU 4892	NNU 4892 K
	4	4	3	3	135	NNU 4992	NNU 4992 K
	12x20°	3	-	2,5	260	316739	-
	6	6	5	5	195	-	NN 3092 K
	6	6	5	5	240	NNU 4092	NNU 4092 K
	7,5	7,5	6	6	535	NNU 4192	NNU 4192 K30
480	5	5	4	4	160	NNU 4996	NNU 4996 K
	6	6	5	5	200	NN 3096	NN 3096 K
	6	6	5	5	275	NNU 4096	NNU 4096 K
	6	6	5	5	345	316189	-
	7,5	7,5	6	6	590	NNU 4196	NNU 4196 K30
487,98	10x20°	4	-	3	170	326196	-
490	16x20°	5	-	4	215	316639	-

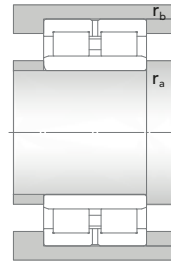
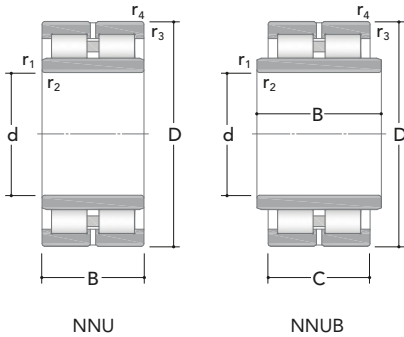

Main dimensions				Basic load ratings		Fatigue	Speed ratings	Designation	
d	D	B	C	Dynamic C	Static C ₀	load limit C _u	Reference	Standard design	
[mm]				[kN]			[rpm]		
500	650	130	-	2035	5050	421	700	319254	
	670	170	-	2295	6050	506	1200	NNU 49/500	
	680	225	-	4166	10880	870	600	314990	
	700	170	-	2688	5360	402	850	320570	
	720	167	-	2705	5780	474	1200	NN 30/500	
	720	218	-	4407	9800	750	800	NNU 40/500	
	720	218	-	4668	10740	810	600	314419	
	830	325	-	7446	14910	1113	600	NNU 41/500	
510	760	400	275	5987	13180	998	600	NNUB 320996	
529,91	870	335		7809	16570	1218	500	312844	
530	710	180	-	2828	7770	638	1060	NNU 49/530	
	760	260	-	5888	14090	1044	600	316536	
	780	185	-	3340	7100	523	1060	NN 30/530	
	780	225	-	4456	9410	688	600	326064	
	780	250	-	4736	10000	750	600	315040	
	780	250	-	5481	12150	896	700	NNU 40/530	
	780	475	285		7222	17220	1284	600	NNUB 320117
	870	335	-	7721	15990	1159	600	NNU 41/530	
546,05	698,5	215,9	-	3586	7620	583	700	464787	
550	800	260	-	5834	13146,5	961	600	316115	
560	735	170	-	2951	6930	559	800	326061	
	740	180	-	2674	7220	560	640	313191	
	750	190	-	3189	8500	683	1010	NNU 49/560	
	820	195	-	3744	7860	575	950	NN 30/560	
	820	258	-	5681	12840	946	670	NNU 40/560	
	920	355	-	8844	18160	1310	560	NNU 41/560	

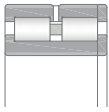

NNUP

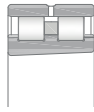

NN

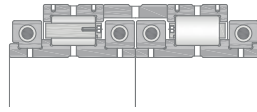

2ROW SCR

Dimensions					Mass	Designation	
d	r _{1,2min}	r _{3,4min}	r _{amax}	r _{bmax}		Cylindrical bore	Tapered bore
[mm]					[kg]		
500	5	5	4	4	120	319254	-
	5	5	4	4	165	NNU 49/500	NNU 49/500 K
	5	2	4	2	250	314990	-
	5	5	4	4	210	320570	-
	6	6	5	5	210	NN 30/500	NN 30/500 K
	6	6	5	5	285	NNU 40/500	NNU 40/500 K
	13,5x20°	6	-	5	310	314419	-
	7,5	7,5	6	6	710	NNU 41/500	NNU 41/500 K30
510	6	3	5	2,5	485	NNUB 320996	-
529,91	7,5	7,5	6	6	830	312844	-
530	5	5	4	4	200	NNU 49/530	NNU 49/530 K
	12x20°	5	-	4	510	316536	-
	6	6	5	5	270	NN 30/530	NN 30/530 K
	20x20°	6	-	5	370	326064	-
	6	6	5	5	400	315040	-
	6	6	5	5	420	NNU 40/530	NNU 40/530 K
	5	5	4	4	560	NNUB 320117	-
	7,5	7,5	6	6	790	NNU 41/530	NNU 41/530 K30
546,05	4	4	3	3	215	464787	-
550	14x20°	6	-	5	455	316115	-
560	5	5	4	4	165	326061	-
	5	5	4	4	215	313191	-
	5	5	4	4	235	NNU 49/560	NNU 49/560 K
	6	6	5	5	315	NN 30/560	NN 30/560 K
	6	6	5	5	475	NNU 40/560	NNU 40/560 K
	7,5	7,5	6	6	930	NNU 41/560	NNU 41/560 K30

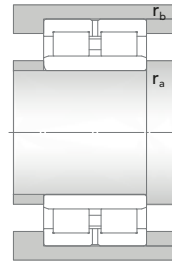
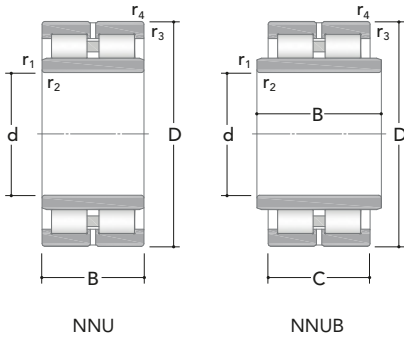

Main dimensions				Basic load ratings		Fatigue	Speed ratings	Designation
d	D	B	C	Dynamic C	Static C ₀	load limit C _u	Reference	Standard design
[mm]				[kN]			[rpm]	
600	800	200	-	3583	10030	787	950	NNU 49/600
	820	287,5	-	6483	17900	1283	500	319584
	870	200	-	3827	8560	604	900	NN 30/600
	870	272	-	6850	15510	1114	600	NNU 40/600
	980	375	-	9802	21080	1452	500	NNU 41/600
630	850	218	-	4038	11260	869	900	NNU 49/630
	920	212	-	4278	9680	672	850	NN 30/630
	920	290	-	7730	17150	1196	600	NNU 40/630
	1030	400	-	10900	23550	1599	480	NNU 41/630
635	762	101,6	-	1670	4540	324	740	319943
650	920	335	-	8697	23080	1592	560	326894
660	880	225	-	4126	11770	828	490	313477
670	900	230	-	4988	13570	921	850	NNU 49/670
	980	230	-	5045	11290	772	800	NN 30/670
	980	308	-	8333	19510	1334	530	NNU 40/670
	1090	412	-	12233	25140	1706	450	NNU 41/670
710	950	243	-	5326	15110	1027	740	NNU 49/710
	1030	236	-	5792	13040	869	710	NN 30/710
	1030	315	-	9482	21580	1459	510	NNU 40/710
	1150	438	-	13517	28470	1898	400	NNU 41/710
723,975	927,2	190	-	4453	11900	813	500	322191
750	920	170	-	3440	10000	706	585	NN 48/750
	1000	250	-	5538	15920	1055	710	NNU 49/750
	1000	250	-	6199	16420	1108	420	314420
	1090	250	-	6976	15990	1039	660	NN 30/750

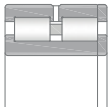

NNUP

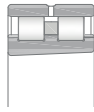

NN

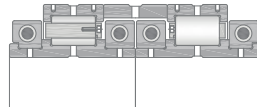

2ROW SCRBB

Dimensions					Mass	Designation	
d	r _{1,2min}	r _{3,4min}	r _{amax}	r _{bmax}		Cylindrical bore	Tapered bore
[mm]					[kg]		
600	5	5	4	4	280	NNU 49/600	NNU 49/600 K
	15x20°	3	-	2,5	470	319584	-
	6	6	5	5	355	NN 30/600	NN 30/600 K
	6	6	5	5	530	NNU 40/600	NNU 40/600 K
	7,5	7,5	6	6	1100	NNU 41/600	NNU 41/600 K30
630	6	6	5	5	355	NNU 49/630	NNU 49/630 K
	7,5	7,5	6	6	430	NN 30/630	NN 30/630 K
	7,5	7,5	6	6	635	NNU 40/630	NNU 40/630 K
	7,5	7,5	6	6	1330	NNU 41/630	NNU 41/630 K30
635	5	5	4	4	86,5	319943	-
650	17x20°	4	-	3	740	326894	-
660	6	6	5	5	390	313477	-
670	6	6	5	5	410	NNU 49/670	NNU 49/670 K
	7,5	7,5	6	6	530	NN 30/670	NN 30/670 K
	7,5	7,5	6	6	765	NNU 40/670	NNU 40/670 K
	7,5	7,5	6	6	1500	NNU 41/670	NNU 41/670 K30
710	6	6	5	5	480	NNU 49/710	NNU 49/710 K
	7,5	7,5	6	6	590	NN 30/710	NN 30/710 K
	7,5	7,5	6	6	850	NNU 40/710	NNU 40/710 K
	9,5	9,5	8	8	1790	NNU 41/710	NNU 41/710 K30
723,975	6	2	5	2	340	322191	-
750	5	5	4	4	240	NN 48/750	NN 48/750 K
	6	6	5	5	540	NNU 49/750	NNU 49/750 K
	6	6	5	5	575	314420	-
	7,5	7,5	6	6	705	NN 30/750	NN 30/750 K

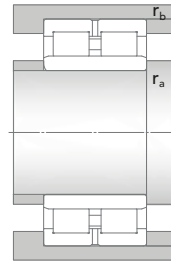
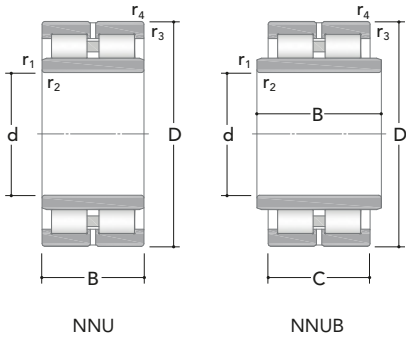

Main dimensions				Basic load ratings		Fatigue	Speed ratings	Designation
d	D	B	C	Dynamic C	Static C ₀	load limit C _u	Reference	Standard design
[mm]				[kN]			[rpm]	
750	1090	335	-	10137	23730	1582	460	NNU 40/750
(cont.)	1220	475	-	16148	35390	2313	400	NNU 41/750
760	1030	400	-	12362	33820	2228	-	239503
800	1060	258	-	5877	16780	1106	-	NNU 49/800
	1150	258	-	7757	17940	1156	-	NN 30/800
	1150	345	-	10942	25890	1693	-	NNU 40/800
	1260	375	-	12836	27810	1788	320	326379
	1280	475	-	16320	40891	2625	360	NNU 41/800
850	1120	272	-	5944	17990	1139	-	NNU 49/850
	1220	272	-	7949	18250	1158	-	NN 30/850
	1220	365	-	11641	28100	1804	-	NNU 40/850
900	1180	280	-	6634	19720	1233	-	NNU 49/900
	1280	280	-	8327	19730	1233	-	NN 30/900
	1280	375	-	12880	31140	1977	-	NNU 40/900
950	1250	300	-	7364	22340	1396	-	NNU 49/950
	1360	300	-	9117	22220	1359	-	NN 30/950
	1360	412	-	14078	35210	2182	-	NNU 40/950
1000	1320	315	-	8676	25620	1577	-	NNU 49/1000
	1320	315	-	8676	25620	1606	-	NN 49/1000
	1420	308	-	10004	24200	1511	-	NN 30/1000
	1420	412	-	15489	37310	2317	-	NNU 40/1000
1060	1400	335	-	10635	30380	1853	-	NNU 49/1060
	1500	325	-	11156	27210	1642	-	NN 30/1060
1120	1460	335	-	10462	31250	1845	-	NNU 49/1120

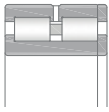

NNUP

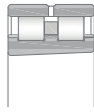

NN

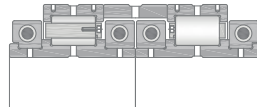

2ROW SCRBB

Dimensions					Mass	Designation	
d	r _{1,2min}	r _{3,4min}	r _{amax}	r _{bmax}		Cylindrical bore	Tapered bore
[mm]					[kg]		
750	7,5	7,5	6	6	925	NNU 40/750	NNU 40/750 K
(cont.)	9,5	9,5	8	8	2230	NNU 41/750	NNU 41/750 K30
760	7,5	4	6	3	1280	239503	-
800	6	6	5	5	615	NNU 49/800	NNU 49/800 K
	7,5	7,5	6	6	790	NN 30/800	NN 30/800 K
	7,5	7,5	6	6	1140	NNU 40/800	NNU 40/800 K
	9,5	9,5	8	8	1850	326379	-
	9,5	9,5	8	8	2390	NNU 41/800	NNU 41/800 K30
850	6	6	5	5	715	NNU 49/850	NNU 49/850 K
	7,5	7,5	6	6	480	NN 30/850	NN 30/850 K
	7,5	7,5	6	6	300	NNU 40/850	NNU 40/850 K
900	6	6	5	5	805	NNU 49/900	NNU 49/900 K
	7,5	7,5	6	6	1050	NN 30/900	NN 30/900 K
	7,5	7,5	6	6	1500	NNU 40/900	NNU 40/900 K
950	7,5	7,5	6	6	960	NNU 49/950	NNU 49/950 K
	7,5	7,5	6	6	1300	NN 30/950	NN 30/950 K
	7,5	7,5	6	6	1900	NNU 40/950	NNU 40/950 K
1000	7,5	7,5	6	6	1250	NNU 49/1000	NNU 49/1000 K
	7,5	7,5	6	6	1200	NN 49/1000	NN 49/1000 K
	7,5	7,5	6	6	1400	NN 30/1000	NN 30/1000 K
	7,5	7,5	6	6	2000	NNU 40/1000	NNU 40/1000 K
1060	7,5	7,5	6	6	1350	NNU 49/1060	NNU 49/1060 K
	9,5	9,5	8	8	1650	NN 30/1060	NN 30/1060 K
1120	7,5	7,5	6	6	1450	NNU 49/1120	NNU 49/1120 K

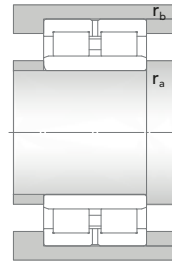
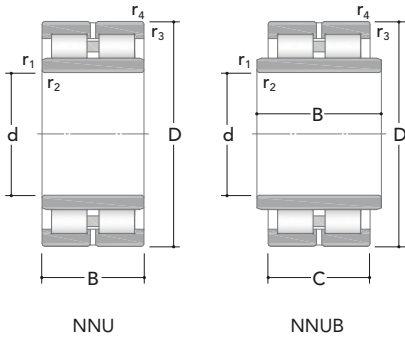

Main dimensions				Basic load ratings		Fatigue load limit	Speed ratings	Designation
d	D	B	C	Dynamic C	Static C ₀	C _u	Reference	Standard design
[mm]				[kN]			[rpm]	
1180	1540	355	-	11803	35290	2078	-	NNU 49/1180
1311	1720	300	-	12421	34120	1978	169	326372
1320	1720	400	-	13845	41980	2420	-	NNU 49/1320
	1720	400	-	13845	41980	2420	-	NN 49/1320

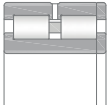

NNUP

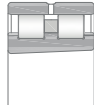

NN

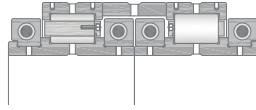

2ROW SCR

Dimensions					Mass	Designation	
d	r _{1,2min}	r _{3,4min}	r _{amax}	r _{bmax}		Cylindrical bore	Tapered bore
[mm]					[kg]		
1180	7,5	7,5	6	6	1650	NNU 49/1180	NNU 49/1180 K
1311	7,5	7,5	6	6	1820	326372	-
1320	7,5	7,5	6	6	3100	NNU 49/1320	NNU 49/1320 K
	7,5	7,5	6	6	3060	NN 49/1320	NN 49/1320 K

Double row full complement cylindrical roller bearings

Double row full complement cylindrical roller bearings feature both solid inner and outer rings, as well as rolling elements properly guided between ribs. Due to that particular design (cageless) they can host the large numbers of rollers, leading to the highest load rating values. On the other side, they allow a maximum rotating speed lower than the classical cage design. Available in non locating, semi-locating and locating design these bearings represent the proper technical solution in several fields and applications.

Internal clearance

Double row full complement cylindrical roller bearings are produced as standard with Normal radial internal clearance CN, but they are also available with C2, C3, and C4 radial internal clearance, in accordance with the ISO 5753:2009. The radial internal clearance values are reported in the **Tab. 1 page 127** and **Tab. 2 page 128** and they are valid only for bearing unmounted and unloaded. The axial internal clearance of NNC and NNCF, which can axially locate the shaft in both directions, is in the range of 0.1 to 0.2 mm for all sizes.



Double row full complement cylindrical roller bearing

Axial displacement

NNCL and NNCF bearing can accommodate axial displacement between shaft and housing within certain limits. As a consequence of the fact that the axial displacement takes between the inner ring and outer ring and not between the inner ring and shaft and outer ring and housing, there is no additional friction during the bearing rotation.

Misalignment

Any misalignment between shaft and seat of the double row full complement cylindrical roller bearing creates a moment load inside the bearing. The bearing life will be obviously affected.

Minimum load

A minimum radial load is requested for a double row full complement cylindrical roller bearings to allow the correct functioning, especially in critical working conditions like: high speed, high acceleration and sudden changes of rotating direction. In these operating conditions, a skidding between the rollers and raceways can be generated by the inertial forces, influencing negatively the bearing life. Minimum radial load can be theoretically estimated using the following formula:

$$F_{rm} > \frac{C_{0r}}{50}$$

Where:

- F_{rm} minimum radial load, [kN];
- C_{0r} basic static load rating, [kN].

Usually, the minimum radial load is reached or surpassed by the weight of the components supported by the bearing together with the loads acting on it, otherwise supplementary radial load must be applied on the double row full complement cylindrical roller bearing.

Designs and variants

Type NNC (SL01)

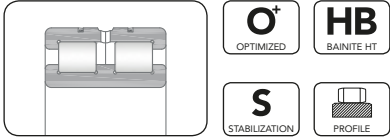

- Split outer ring with two integral ribs, clamped with a retaining ring
- Inner ring with three integral ribs
- Full complement (cageless) design for increased load carrying capacities
- Reduced maximum rotational speed compared to caged design
- Annular groove and lubrication holes in outer ring
- Optimized raceway geometry and roller profile
- Can be used in locating position

Type NNF (SL04)

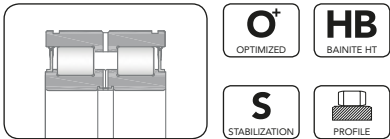

- Outer ring with one central integral rib
- Split inner ring with three integral ribs, clamped with a retaining ring
- Full complement (cageless) design for increased load carrying capacities
- Reduced maximum rotational speed
- Annular groove and lubrication holes in outer and inner ring
- Optimized raceway geometry and roller profile
- Integrated rubber seals on both bearing sides to avoid contamination
- Available filled with grease
- Can be used in locating position

Type NNCL (SL02)

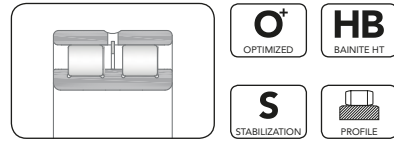

- Ribless outer ring
- Inner ring with three integral ribs
- Full complement (cageless) design for increased load carrying capacities
- Reduced maximum rotational speed compared to caged design
- Annular groove and lubrication holes in outer ring
- Separating ring between the two rows of rollers
- Optimized raceway geometry and roller profile
- Can be used in locating position

Type NNCF

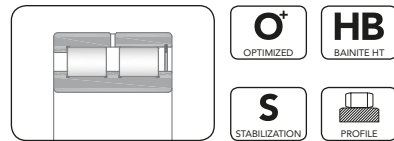

- Outer ring with one integral side rib and retaining ring
- Inner ring with three integral ribs
- Full complement (cageless) design for increased load carrying capacities
- Reduced maximum rotational speed compared to caged design
- Optimized raceway geometry and roller profile
- Can be used in one direction locating position (semi-locating design)
- Available with annular groove and lubrication holes in outer or inner ring

Suffixes	Internal Design
DA	Modified snap ring grooves in outer ring and two-piece inner ring held together by retaining ring
ADA	Wider snap ring grooves in outer ring and two-piece inner ring held together by retaining ring
OD	Special outer diameter. The number immediately following the OD gives the outer diameter in mm
B	Special bearing width. The number immediately following the B gives the width in mm
SP	Special or non-standard bearing
ZB	Optimized roller profile for improved load distribution. It is not necessarily stated in the bearing code

Suffixes	Cage
V	Full complement of rolling elements (without cage)

Suffixes	Lubrication
G	Helical groove in inner ring bore (not necessarily stated)
ISR3	Annular groove and three lubrication holes in inner ring
W33	Annular groove and three lubrication holes in outer ring
W33X	Annular groove and more than three lubrication holes in outer ring
W77X	Annular groove and more than three plugged lubrication holes in outer ring
W	Lubrication grooves in the side faces of inner and outer rings (not necessarily stated)
WI	Lubrication grooves in the side face of inner ring (not necessarily stated)
WO	Lubrication grooves in the side face of outer ring (not necessarily stated)

Suffixes	External design
P	Contact seal on one side (3194 series)
PP	Contact seal on both sides (NNF 50 series)
LS	Contact seal on one side (NNF 50 series)
2LS	Contact seal on both sides (3194 series)
NR	Snap ring groove in outer ring with suitable snap ring



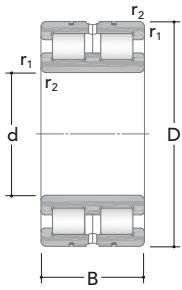

NNC (SL01)

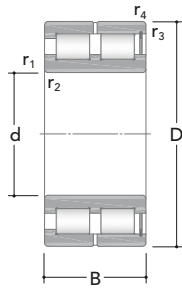

NNCF

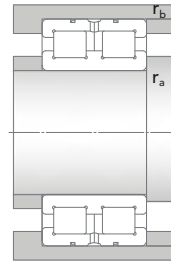

Main dimensions			Basic load ratings		Fatigue load limit	Speed ratings		Designation
d	D	B	Dynamic C	Static C ₀	C _u	Reference	Limiting	Standard design
[mm]			[kN]			[rpm]		
20	42	30	52,4	56,3	6,1	8300	8800	NNCF 5004 V
25	47	30	59	69,6	7,5	6700	7900	NNCF 5005 V
30	55	34	73,8	86,5	10	5800	6400	NNCF 5006 V
35	62	36	89,5	110	12,7	5100	5800	NNCF 5007 V
40	68	38	105	139	17	4600	5200	NNCF 5008 V
45	75	40	113	155	18,2	4100	4700	NNCF 5009 V
50	80	40	144	193	23,2	3800	4300	NNCF 5010 V
55	90	46	189	275	33,9	3300	3700	NNCF 5011 V
60	85	25	77,7	135	14,1	3400	3900	NNCF 4912 V
	85	25	77,7	135	14,1	3400	3900	NNC 4912 V
	85	25	77,7	135	14,1	3400	3900	NNCL 4912 V
	95	46	197	299	36,4	3200	3500	NNCF 5012 V
65	100	46	211	321	40	2900	3400	NNCF 5013 V
70	100	30	113	192	22,3	2900	3300	NNCF 4914 V
	100	30	113	192	22,3	2900	3300	NNC 4914 V
	100	30	113	192	22,3	2900	3300	NNCL 4914 V
	110	54	235	343	45	2700	3100	NNCF 5014 V
75	115	54	249	377	49	2500	2700	NNCF 5015 V
80	110	30	121	213	25	2500	3000	NNCF 4916 V
	110	30	121	213	25	2500	2900	NNC 4916 V
	110	30	121	213	25	2500	2900	NNCL 4916 V

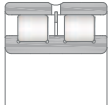

NNCL (SL02)

Dimensions					Mass	Designation
d	r _{1,2min}	r _{3,4min}	r _{amax}	r _{bmax}		Standard design
[mm]					[kg]	
20	0,6	0,3	0,5	0,3	0,2	NNCF 5004 V
25	0,6	0,3	0,5	0,3	0,23	NNCF 5005 V
30	1	0,3	1	0,3	0,35	NNCF 5006 V
35	1	0,3	1	0,3	0,46	NNCF 5007 V
40	1	0,3	1	0,3	0,56	NNCF 5008 V
45	1	0,3	1	0,3	0,71	NNCF 5009 V
50	1	0,3	1	0,3	0,76	NNCF 5010 V
55	1,1	0,6	1	0,5	1,15	NNCF 5011 V
60	1	1	1	1	0,48	NNCF 4912 V
	1	-	1	-	0,49	NNC 4912 V
	1	-	1	-	0,47	NNCL 4912 V
	1,1	0,6	1	0,5	1,25	NNCF 5012 V
65	1,1	0,6	1	0,5	1,3	NNCF 5013 V
70	1	1	1	1	0,77	NNCF 4914 V
	1	-	1	-	0,78	NNC 4914 V
	1	-	1	-	0,75	NNCL 4914 V
	1,1	0,6	1	0,5	1,85	NNCF 5014 V
75	1,1	0,6	1	0,5	1,95	NNCF 5015 V
80	1	1	1	1	0,87	NNCF 4916 V
	1	-	1	-	0,88	NNC 4916 V
	1	-	1	-	0,85	NNCL 4916 V

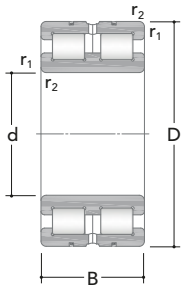

NNC (SL01)

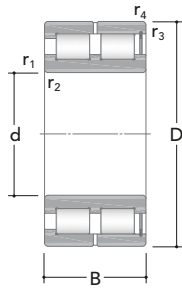

NNCF

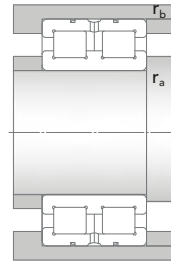

Main dimensions			Basic load ratings		Fatigue load limit	Speed ratings		Designation
d	D	B	Dynamic C	Static C ₀	C _u	Reference	Limiting	Standard design
[mm]			[kN]			[rpm]		
80	125	60	305	452	58,1	2300	2600	NNCF 5016 V
(cont.)								
85	130	60	318	472	60	2300	2600	NNCF 5017 V
90	125	35	160	296	35	2300	2700	NNCF 4918 V
	125	35	160	296	35	2300	2600	NNC 4918 V
	125	35	160	296	35	2300	2600	NNCL 4918 V
	140	67	364	552	68,5	2100	2500	NNCF 5018 V
100	140	40	208	399	46,4	1900	2300	NNCF 4920 V
	140	40	208	399	46,4	1900	2300	NNC 4920 V
	140	40	208	399	46,4	1900	2200	NNCL 4920 V
	150	67	392	614	74	1900	2200	NNCF 5020 V
105	145	47	233	474	55	1960,000	-	319372
110	150	40	221	429	49	1800	2100	NNCF 4922 V
	150	40	221	429	49	1800	2100	NNC 4922 V
	150	40	221	429	49	1800	2100	NNCL 4922 V
	170	80	513	799	95	1700	1900	NNCF 5022 V
120	165	45	240	478	53	1600	1900	NNCF 4924 V
	165	45	240	478	53	1600	1900	NNC 4924 V
	165	45	240	478	53	1600	1900	NNCL 4924 V
	180	80	546	878	104	1600	1800	NNCF 5024 V
130	180	50	297	529	60	1500	1700	NNCF 4926 V
	180	50	297	529	60	1500	1700	NNC 4926 V
	180	50	297	529	60	1500	1700	NNCL 4926 V
	200	95	757	1238	142	1400	1700	NNCF 5026 V
140	190	50	307	566	63	1400	1600	NNCF 4928 V
	190	50	307	566	63	1400	1700	NNC 4928 V

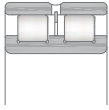

NNCL (SL02)

Dimensions					Mass	Designation
d	r _{1,2min}	r _{3,4min}	r _{amax}	r _{bmax}		Standard design
[mm]					[kg]	
80	1,1	0,6	1	0,5	2,6	NNCF 5016 V
(cont.)						
85	1,1	0,6	1	0,5	2,7	NNCF 5017 V
90	1,1	1,1	1	1	1,35	NNCF 4918 V
	1,1	-	1	-	1,35	NNC 4918 V
	1,1	-	1	-	1,3	NNCL 4918 V
	1,5	1	1,5	1	3,6	NNCF 5018 V
100	1,1	1,1	1	1	1,95	NNCF 4920 V
	1,1	-	1	-	1,95	NNC 4920 V
	1,1	-	1	-	1,9	NNCL 4920 V
	1,5	1	1,5	1	3,95	NNCF 5020 V
105	1,1	1,1	1	1	2,4	319372
110	1,1	1,1	1	1	2,1	NNCF 4922 V
	1,1	-	1	-	2,15	NNC 4922 V
	1,1	-	1	-	2,1	NNCL 4922 V
	2	1	2	1	6,3	NNCF 5022 V
120	1,1	1,1	1	1	2,9	NNCF 4924 V
	1,1	-	1	-	2,95	NNC 4924 V
	1,1	-	1	-	2,85	NNCL 4924 V
	2	1	2	1	6,75	NNCF 5024 V
130	1,5	1,5	1,5	1,5	3,9	NNCF 4926 V
	1,5	-	1,5	-	3,95	NNC 4926 V
	1,5	-	1,5	-	3,8	NNCL 4926 V
	2	1	2	1	10	NNCF 5026 V
140	1,5	1,5	1,5	1,5	4,15	NNCF 4928 V
	1,5	-	1,5	-	4,2	NNC 4928 V

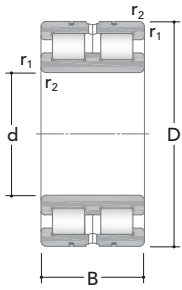

NNC (SL01)

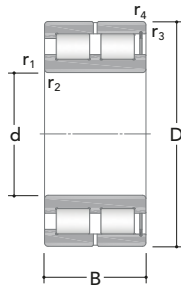

NNCF

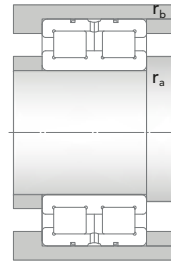

Main dimensions			Basic load ratings		Fatigue load limit	Speed ratings		Designation
d	D	B	Dynamic C	Static C ₀	C _u	Reference	Limiting	Standard design
[mm]			[kN]			[rpm]		
140 (cont.)	190	50	307	566	63	1400	1700	NNCL 4928 V
	210	95	802	1350	151	1300	1600	NNCF 5028 V
150	190	40	253	574	59	1400	1600	NNCF 4830 V
	190	40	253	574	59	1400	1600	NNC 4830 V
	190	40	253	574	59	1400	1600	NNCL 4830 V
	210	60	432	816	90	1300	1500	NNCF 4930 V
	210	60	432	816	90	1300	1500	NNC 4930 V
	210	60	432	816	90	1300	1500	NNCL 4930 V
	225	100	837	1429	160	1200	1500	NNCF 5030 V
160	200	40	261	603	61	1300	1500	NNCF 4832 V
	200	40	261	603	61	1300	1500	NNC 4832 V
	200	40	261	603	61	1300	1500	NNCL 4832 V
	220	60	442	899	94,8	1200	1400	NNCF 4932 V
	220	60	442	899	94,8	1200	1400	NNC 4932 V
	220	60	442	899	94,8	1200	1400	NNCL 4932 V
	240	109	960	1590	179	1100	1300	NNCF 5032 V
170	215	45	286	647	64,7	1200	1400	NNCF 4834 V
	215	45	286	647	64,7	1200	1400	NNC 4834 V
	215	45	286	647	64,7	1200	1400	NNCL 4834 V
	230	60	459	932	98	1100	1300	NNCF 4934 V
	230	60	459	932	98	1100	1300	NNC 4934 V
	230	60	459	932	98	1100	1300	NNCL 4934 V
	260	122	1240	2090	233	1000	1200	NNCF 5034 V
180	225	45	297	689	68,9	1100	1300	NNCF 4836 V
	225	45	297	689	68,9	1100	1300	NNC 4836 V
	225	45	297	689	68,9	1100	1300	NNCL 4836 V
	250	69	590	1210	126	1000	1200	NNCF 4936 V
	250	69	590	1210	126	1000	1200	NNC 4936 V
	250	69	590	1210	126	1000	1200	NNCL 4936 V

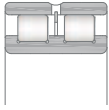

NNCL (SL02)

Dimensions					Mass	Designation
d	r _{1,2min}	r _{3,4min}	r _{amax}	r _{bmax}		Standard design
[mm]					[kg]	
140	1,5	-	1,5	-	4,1	NNCL 4928 V
	(cont.) 2	1	2	1	11	NNCF 5028 V
150	1,1	1,1	1	1	2,8	NNCF 4830 V
	1,1	-	1	-	2,9	NNC 4830 V
	1,1	-	1	-	2,7	NNCL 4830 V
	2	2	2	2	6,55	NNCF 4930 V
	2	-	2	-	6,65	NNC 4930 V
	2	-	2	-	6,45	NNCL 4930 V
	2	1,1	2	1	13,5	NNCF 5030 V
160	1,1	1,1	1	1	3	NNCF 4832 V
	1,1	-	1	-	3,1	NNC 4832 V
	1,1	-	1	-	2,9	NNCL 4832 V
	2	2	2	2	6,9	NNCF 4932 V
	2	-	2	-	7	NNC 4932 V
	2	-	2	-	6,8	NNCL 4932 V
	2,1	1,1	2	1	16	NNCF 5032 V
170	1,1	1,1	1	1	4	NNCF 4834 V
	1,1	-	1	-	4,1	NNC 4834 V
	1,1	-	1	-	3,9	NNCL 4834 V
	2	2	2	2	7,2	NNCF 4934 V
	2	-	2	-	7,35	NNC 4934 V
	2	-	2	-	7,1	NNCL 4934 V
	2,1	1,1	2	1	23	NNCF 5034 V
180	1,1	1,1	1	1	4,2	NNCF 4836 V
	1,1	-	1	-	4,3	NNC 4836 V
	1,1	-	1	-	4,1	NNCL 4836 V
	2	2	2	2	10,5	NNCF 4936 V
	2	-	2	-	11	NNC 4936 V
	2	-	2	-	10,5	NNCL 4936 V

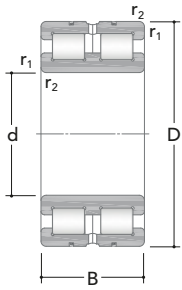

NNC (SL01)

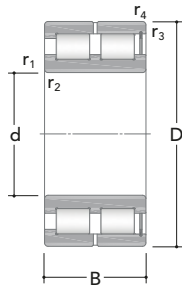

NNCF

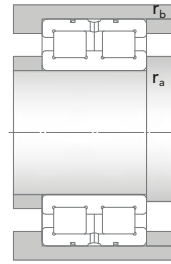

Main dimensions			Basic load ratings		Fatigue load limit	Speed ratings		Designation
d	D	B	Dynamic C	Static C ₀	C _u	Reference	Limiting	Standard design
[mm]			[kN]			[rpm]		
180	280	136	1441	2460	266	1000	1100	NNCF 5036 V
(cont.)								
190	240	50	357	744	75,9	1000	1200	NNCF 4838 V
	240	50	357	744	75,9	1000	1300	NNC 4838 V
	240	50	357	744	75,9	1000	1200	NNCL 4838 V
	260	69	600	1288	132	1000	1200	NNCF 4938 V
	260	69	600	1288	131	1000	1200	NNC 4938 V
	260	69	600	1288	132	1000	1200	NNCL 4938 V
	290	136	1482	2590	279	1000	1100	NNCF 5038 V
200	250	50	366	793	79	1000	1200	NNCF 4840 V
	250	50	366	793	79	1000	1200	NNC 4840 V
	250	50	366	793	79	1000	1200	NNCL 4840 V
	280	80	696	1470	150	1000	1100	NNCF 4940 V
	280	80	696	1470	150	1000	1100	NNC 4940 V
	280	80	696	1470	150	1000	1200	NNCL 4940 V
	310	150	1705	3020	317	900	1040	NNCF 5040 V
220	270	50	378	853	84	1000	1100	NNCF 4844 V
	270	50	378	853	84	1000	1050	NNC 4844 V
	270	50	378	853	84	1000	1100	NNCL 4844 V
	300	80	739	1580	158	900	1030	NNCF 4944 V
	300	80	739	1580	158	900	1100	NNC 4944 V
	300	80	739	1580	158	900	1040	NNCL 4944 V
	340	160	2028	3580	373	800	940	NNCF 5044 V
240	300	60	534	1305	127	900	1000	NNCF 4848 V
	300	60	534	1305	126	900	950	NNC 4848 V
	300	60	534	1305	125	900	1000	NNCL 4848 V
	320	80	784	1750	172	800	1000	NNCF 4948 V
	320	80	784	1750	172	800	1000	NNC 4948 V
	320	80	784	1750	172	800	1000	NNCL 4948 V
	360	160	2143	3840	394	800	900	NNCF 5048 V

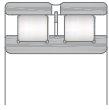

NNCL (SL02)

Dimensions					Mass	Designation
d	r _{1,2min}	r _{3,4min}	r _{amax}	r _{bmax}		Standard design
[mm]					[kg]	
180	2,1	2,1	2	2	30,5	NNCF 5036 V
(cont.)						
190	1,5	1,5	1,5	1,5	5,5	NNCF 4838 V
	1,5	-	1,5	-	5,65	NNC 4838 V
	1,5	-	1,5	-	5,3	NNCL 4838 V
	2	2	2	2	11	NNCF 4938 V
	2	-	2	-	11	NNC 4938 V
	2	-	2	-	11	NNCL 4938 V
	2,1	2,1	2	2	31,5	NNCF 5038 V
200	1,5	1,5	1,5	1,5	5,8	NNCF 4840 V
	1,5	-	1,5	-	5,9	NNC 4840 V
	1,5	-	1,5	-	5,7	NNCL 4840 V
	2,1	2,1	2	2	15,5	NNCF 4940 V
	2,1	-	2	-	16	NNC 4940 V
	2,1	-	2	-	15,5	NNCL 4940 V
	2,1	2,1	2	2	41	NNCF 5040 V
220	1,5	1,5	1,5	1,5	6,3	NNCF 4844 V
	1,5	-	1,5	-	6,4	NNC 4844 V
	1,5	-	1,5	-	6,2	NNCL 4844 V
	2,1	2,1	2	2	17	NNCF 4944 V
	2,1	-	2	-	17	NNC 4944 V
	2,1	-	2	-	17	NNCL 4944 V
	3	3	2,5	2,5	52,5	NNCF 5044 V
240	2	2	2	2	9,9	NNCF 4848 V
	2	-	2	-	10	NNC 4848 V
	2	-	2	-	9,8	NNCL 4848 V
	2,1	2,1	2	2	18,5	NNCF 4948 V
	2,1	-	2	-	18,5	NNC 4948 V
	2,1	-	2	-	18	NNCL 4948 V
	3	3	2,5	2,5	56	NNCF 5048 V

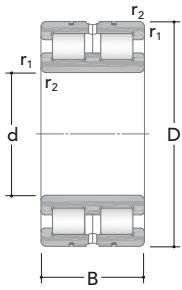

NNC (SL01)

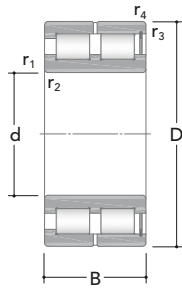

NNCF

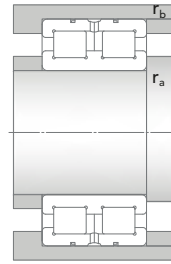

Main dimensions			Basic load ratings		Fatigue load limit	Speed ratings		Designation
d	D	B	Dynamic C	Static C ₀	C _u	Reference	Limiting	Standard design
[mm]			[kN]			[rpm]		
260	320	60	556	1380	130	800	900	NNCF 4852 V
	320	60	556	1380	130	800	900	NNC 4852 V
	320	60	556	1380	130	800	900	NNCL 4852 V
	360	100	1168	2540	244	700	830	NNCF 4952 V
	360	100	1168	2540	244	700	820	NNC 4952 V
	360	100	1168	2540	244	700	810	NNCL 4952 V
280	400	190	2833	5050	495	700	780	NNCF 5052 V
	350	69	741	1830	170	700	820	NNCF 4856 V
		69	741	1830	170	700	820	NNC 4856 V
		69	741	1830	170	700	820	NNCL 4856 V
	380	100	1215	2695	252	700	800	NNCF 4956 V
		100	1215	2695	255	700	800	NNC 4956 V
100		1215	2695	259	700	800	NNCL 4956 V	
300	420	190	2902	5220	512	700	750	NNCF 5056 V
	380	80	858	2110	195	700	730	NNCF 4860 V
		80	858	2110	195	700	740	NNC 4860 V
		80	858	2110	195	700	800	NNCL 4860 V
	420	118	1681	3700	350	700	700	NNCF 4960 V
		118	1681	3700	350	700	700	NNC 4960 V
118		1681	3700	350	700	700	NNCL 4960 V	
320	460	218	3530	6540	599	600	700	NNCF 5060 V
	400	80	897	2270	207	600	700	NNCF 4864 V
		80	897	2270	207	600	700	NNC 4864 V
		80	897	2270	207	600	700	NNCL 4864 V
	440	118	1762	3990	369	600	700	NNCF 4964 V
		118	1762	3990	369	600	700	NNC 4964 V
118		1762	3990	369	600	700	NNCL 4964 V	
340	480	218	3682	6940	619	500	600	NNCF 5064 V
	420	80	925	2380	214	600	700	NNCF 4868 V

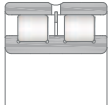

NNCL (SL02)

Dimensions					Mass	Designation
d	r _{1,2min}	r _{3,4min}	r _{amax}	r _{bmax}		Standard design
[mm]					[kg]	
260	2	2	2	2	11	NNCF 4852 V
	2	-	2	-	11	NNC 4852 V
	2	-	2	-	10,5	NNCL 4852 V
	2,1	2,1	2	2	31,5	NNCF 4952 V
	2,1	-	2	-	32	NNC 4952 V
	2,1	-	2	-	31	NNCL 4952 V
	4	4	3	3	85,5	NNCF 5052 V
280	2	2	2	2	16	NNCF 4856 V
	2	-	2	-	16	NNC 4856 V
	2	-	2	-	15,5	NNCL 4856 V
	2,1	2,1	2	2	33,5	NNCF 4956 V
	2,1	-	2	-	34	NNC 4956 V
	2,1	-	2	-	33	NNCL 4956 V
	4	4	3	3	90,5	NNCF 5056 V
300	2,1	2,1	2	2	22,5	NNCF 4860 V
	2,1	-	2	-	23	NNC 4860 V
	2,1	-	2	-	22	NNCL 4860 V
	3	3	2,5	2,5	52,5	NNCF 4960 V
	3	-	2,5	-	53	NNC 4960 V
	3	-	2,5	-	52	NNCL 4960 V
	4	4	3	3	130	NNCF 5060 V
320	2,1	2,1	2	2	23,5	NNCF 4864 V
	2,1	-	2	-	24	NNC 4864 V
	2,1	-	2	-	23	NNCL 4864 V
	3	3	2,5	2,5	55,5	NNCF 4964 V
	3	-	2,5	-	56	NNC 4964 V
	3	-	2,5	-	55	NNCL 4964 V
	4	4	3	3	135	NNCF 5064 V
340	2,1	2,1	2	2	25	NNCF 4868 V

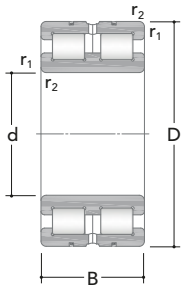

NNC (SL01)

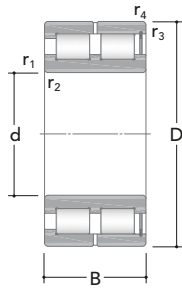

NNCF

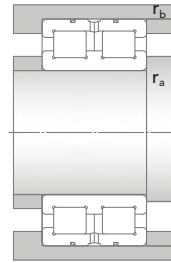

Main dimensions			Basic load ratings		Fatigue load limit	Speed ratings		Designation
d	D	B	Dynamic C	Static C ₀	C _u	Reference	Limiting	Standard design
[mm]			[kN]			[rpm]		
340	420	80	925	2380	214	600	700	NNC 4868 V
(cont.)	420	80	925	2380	214	600	650	NNCL 4868 V
	460	118	1785	4210	386	500	600	NNCF 4968 V
	460	118	1785	4210	386	500	600	NNC 4968 V
	460	118	1785	4210	386	500	600	NNCL 4968 V
	520	243	4334	8250	706	500	600	NNCF 5068 V
360	440	80	939	2520	221	500	600	NNCF 4872 V
	440	80	939	2520	221	500	600	NNC 4872 V
	440	80	939	2520	221	500	600	NNCL 4872 V
	480	118	1849	4470	402	500	600	NNCF 4972 V
	480	118	1849	4470	402	500	600	NNC 4972 V
	480	118	1849	4470	402	500	600	NNCL 4972 V
	540	243	4330	8480	721	500	550	NNCF 5072 V
380	480	100	1392	3620	312	500	570	NNCF 4876 V
	480	100	1392	3620	312	500	570	NNC 4876 V
	480	100	1392	3620	312	500	570	NNCL 4876 V
	520	140	2355	5630	494	500	550	NNCF 4976 V
	520	140	2355	5630	494	500	560	NNC 4976 V
	520	140	2355	5630	494	500	540	NNCL 4976 V
	560	243	4679	9050	742	500	510	NNCF 5076 V
400	500	100	1418	3740	324	500	540	NNCF 4880 V
	500	100	1418	3740	324	500	560	NNC 4880 V
	500	100	1418	3740	324	500	550	NNCL 4880 V
	540	140	2454	5990	519	500	510	NNCF 4980 V
	540	140	2454	5990	519	500	510	NNC 4980 V
	540	140	2454	5990	519	500	510	NNCL 4980 V
	600	272	5484	10990	899	440	500	NNCF 5080 V
420	520	100	1347	3920	319	460	-	NNCF 4884 V
	520	100	1347	3920	319	480	-	NNC 4884 V

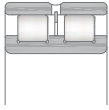

NNCL (SL02)

Dimensions					Mass	Designation
d	r _{1,2min}	r _{3,4min}	r _{amax}	r _{bmax}		Standard design
[mm]					[kg]	
340	2,1	-	2	-	25,5	NNC 4868 V
(cont.)	2,1	-	2	-	25,5	NNCL 4868 V
	3	3	2,5	2,5	58,5	NNCF 4968 V
	3	-	2,5	-	59	NNC 4968 V
	3	-	2,5	-	58	NNCL 4968 V
	5	5	4	4	185	NNCF 5068 V
360	2,1	2,1	2	2	26,5	NNCF 4872 V
	2,1	-	2	-	27	NNC 4872 V
	2,1	-	2	-	26	NNCL 4872 V
	3	3	2,5	2,5	61,5	NNCF 4972 V
	3	-	2,5	-	62	NNC 4972 V
	3	-	2,5	-	61	NNCL 4972 V
	5	5	4	4	195	NNCF 5072 V
380	2,1	2,1	2	2	45	NNCF 4876 V
	2,1	-	2	-	45,5	NNC 4876 V
	2,1	-	2	-	44	NNCL 4876 V
	4	4	3	3	91,5	NNCF 4976 V
	4	-	3	-	92,5	NNC 4976 V
	4	-	3	-	90,5	NNCL 4976 V
	5	5	4	4	200	NNCF 5076 V
400	2,1	2,1	2	2	46	NNCF 4880 V
	2,1	-	2	-	46,5	NNC 4880 V
	2,1	-	2	-	46	NNCL 4880 V
	4	4	3	3	95,5	NNCF 4980 V
	4	-	3	-	96,5	NNC 4980 V
	4	-	3	-	94,5	NNCL 4980 V
	5	5	4	4	270	NNCF 5080 V
420	2,1	2,1	2	2	49,5	NNCF 4884 V
	2,1	-	2	-	49,5	NNC 4884 V

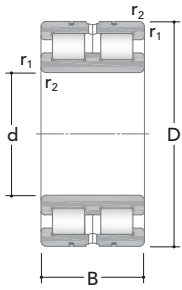

NNC (SL01)

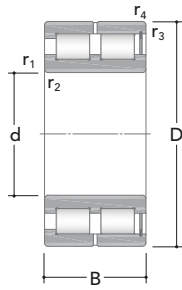

NNCF

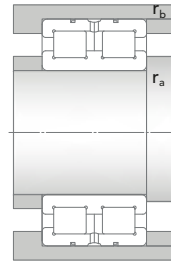

Main dimensions			Basic load ratings		Fatigue load limit	Speed ratings		Designation
d	D	B	Dynamic C	Static C ₀	C _u	Reference	Limiting	Standard design
[mm]			[kN]			[rpm]		
420 (cont.)	520	100	1347	3920	319	500	-	NNCL 4884 V
	560	140	2217	5980	508	430	-	NNCF 4984 V
	560	140	2217	5980	508	460	-	NNC 4984 V
	560	140	2217	5980	508	470	-	NNCL 4984 V
440	540	100	1414	4080	334	440	-	NNCF 4888 V
	540	100	1414	4080	334	450	-	NNC 4888 V
	540	100	1414	4080	334	460	-	NNCL 4888 V
	600	160	3000	7460	637	420	-	NNCF 4988 V
	600	160	3000	7460	635	450	-	NNC 4988 V
	600	160	3000	7460	635	420	-	NNCL 4988 V
460	580	118	1555	4470	373	420	-	NNCF 4892 V
	580	118	1555	4470	373	420	-	NNC 4892 V
	580	118	1555	4470	373	440	-	NNCL 4892 V
	620	160	3027	7590	650	390	-	NNCF 4992 V
	620	160	3027	7590	650	390	-	NNC 4992 V
	620	160	3027	7590	650	410	-	NNCL 4992 V
480	600	118	1572	4680	384	390	-	NNCF 4896 V
	600	118	1572	4680	384	410	-	NNC 4896 V
	600	118	1572	4680	384	390	-	NNCL 4896 V
	650	170	3314	8210	702	380	-	NNCF 4996 V
	650	170	3314	8210	702	390	-	NNC 4996 V
	650	170	3314	8210	702	370	-	NNCL 4996 V
500	620	118	1596	4840	385	420	-	NNCF 48/500 V
	620	118	1596	4840	385	390	-	NNC 48/500 V
	620	118	1596	4840	385	390	-	NNCL 48/500 V
	670	170	3364	8790	734	370	-	NNCF 49/500 V
	670	170	3364	8790	734	360	-	NNC 49/500 V
	670	170	3364	8790	734	370	-	NNCL 49/500 V

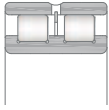

NNCL (SL02)

Dimensions					Mass	Designation
d	r _{1,2min}	r _{3,4min}	r _{amax}	r _{bmax}		Standard design
[mm]					[kg]	
420	2,1	-	2	-	49,5	NNCL 4884 V
(cont.)	4	4	3	3	99,5	NNCF 4984 V
	4	-	3	-	99,5	NNC 4984 V
	4	-	3	-	99,5	NNCL 4984 V
440	2,1	2,1	2	2	52	NNCF 4888 V
	2,1	-	2	-	52	NNC 4888 V
	2,1	-	2	-	52	NNCL 4888 V
	4	4	3	3	137	NNCF 4988 V
	4	-	3	-	137	NNC 4988 V
	4	-	3	-	137	NNCL 4988 V
460	3	3	2,5	2,5	76	NNCF 4892 V
	3	-	2,5	-	76	NNC 4892 V
	3	-	2,5	-	76	NNCL 4892 V
	4	4	3	3	140	NNCF 4992 V
	4	-	3	-	140	NNC 4992 V
	4	-	3	-	140	NNCL 4992 V
480	3	3	2,5	2,5	78,5	NNCF 4896 V
	3	-	2,5	-	78,5	NNC 4896 V
	3	-	2,5	-	78,5	NNCL 4896 V
	5	5	4	4	165	NNCF 4996 V
	5	-	4	-	165	NNC 4996 V
	5	-	4	-	165	NNCL 4996 V
500	3	3	2,5	2,5	81,5	NNCF 48/500 V
	3	-	2,5	-	81,5	NNC 48/500 V
	3	-	2,5	-	81,5	NNCL 48/500 V
	5	5	4	4	175	NNCF 49/500 V
	5	-	4	-	175	NNC 49/500 V
	5	-	4	-	175	NNCL 49/500 V

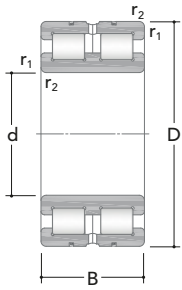

NNC (SL01)

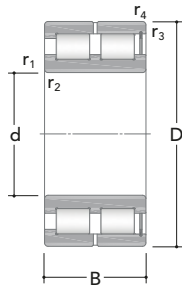

NNCF

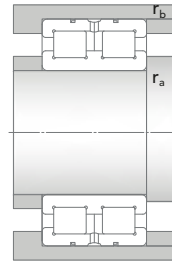

Main dimensions			Basic load ratings		Fatigue load limit	Speed ratings		Designation
d	D	B	Dynamic C	Static C ₀	C _u	Reference	Limiting	Standard design
[mm]			[kN]			[rpm]		
530	650	118	1695	5320	419	370	-	NNCF 48/530 V
	650	118	1695	5320	419	370	-	NNC 48/530 V
	650	118	1695	5320	419	350	-	NNCL 48/530 V
	710	180	3925	10160	827	330	-	NNCF 49/530 V
	710	180	3925	10160	827	330	-	NNC 49/530 V
	710	180	3925	10160	827	330	-	NNCL 49/530 V

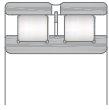

NNCL (SL02)

Dimensions					Mass	Designation
d	r _{1,2min}	r _{3,4min}	r _{amax}	r _{bmax}		Standard design
[mm]					[kg]	
530	3	3	2,5	2,5	85	NNCF 48/530 V
	3	-	2,5	-	86	NNC 48/530 V
	3	-	2,5	-	84	NNCL 48/530 V
	5	5	4	4	200	NNCF 49/530 V
	5	-	4	-	200	NNC 49/530 V
	5	-	4	-	200	NNCL 49/530 V

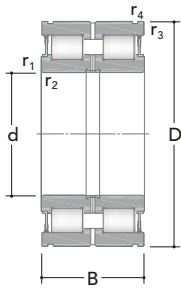

NNF (SL04)

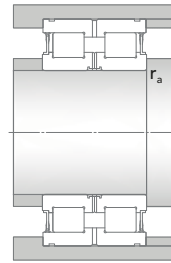

Main dimensions				Basic load ratings		Fatigue load limit	Speed ratings	Designation
d	D	B	C	Dynamic C	Static C ₀	C _u	Limiting	Standard design
[mm]				[kN]			[rpm]	
20	42	30	29	45,8	54,6	5,7	3000	NNF 5004
25	47	30	29	50,7	65	6,7	2700	NNF 5005
30	55	34	33	57,8	74	7,7	2300	NNF 5006
35	62	36	35	69,4	97,9	10,6	1900	NNF 5007
40	68	38	37	85	114,3	13	1800	NNF 5008
45	75	40	39	101,7	145,7	17	1600	NNF 5009
50	80	40	39	109	158	18,4	1500	NNF 5010
55	90	46	45	128	195	23	1300	NNF 5011
60	95	46	45	136	207	25	1200	NNF 5012
65	100	46	45	136	220	26	1200	NNF 5013
70	110	54	53	187	284	34,4	1100	NNF 5014
75	115	54	53	227	309	40	1000	NNF 5015
80	125	60	59	251	411	52	900	NNF 5016
85	130	60	59	270	422	54	900	NNF 5017
90	140	67	66	317	545	68,9	800	NNF 5018
95	145	67	66	329	564	70	800	NNF 5019
100	150	67	66	335	569	68	800	NNF 5020

Dimensions				Mass	Designation
d	r _{1,2min}	r _{3,4min}	r _{amax}		Standard design
[mm]				[kg]	
20	0,5	0,3	0,3	0,2	NNF 5004
25	0,5	0,3	0,3	0,24	NNF 5005
30	0,5	0,3	0,3	0,37	NNF 5006
35	0,5	0,3	0,3	0,48	NNF 5007
40	0,8	0,6	0,4	0,56	NNF 5008
45	0,8	0,6	0,4	0,7	NNF 5009
50	0,8	0,6	0,4	0,76	NNF 5010
55	1	0,6	0,6	1,2	NNF 5011
60	1	0,6	0,6	1,25	NNF 5012
65	1	0,6	0,6	1,35	NNF 5013
70	1	0,6	0,6	1,85	NNF 5014
75	1	0,6	0,6	1,95	NNF 5015
80	1,5	0,6	1	2,7	NNF 5016
85	1,5	0,6	1	2,85	NNF 5017
90	1,5	0,6	1	3,7	NNF 5018
95	1,5	0,6	1	3,9	NNF 5019
100	1,5	0,6	1	3,95	NNF 5020

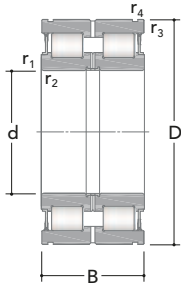

NNF (SL04)

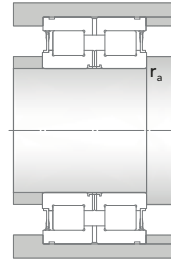

Main dimensions				Basic load ratings		Fatigue load limit	Speed ratings	Designation
d	D	B	C	Dynamic C	Static C ₀	C _u	Limiting	Standard design
[mm]				[kN]			[rpm]	
110	170	80	79	410	693	81,3	700	NNF 5022
120	180	80	79	426	851	85,1	620	NNF 5024
130	190	69	68	382	731	83	600	319110
	190	80	79	443	800	89,8	600	319426
	200	95	94	622	1044	118	600	NNF 5026
140	200	80	79	468	861	96,1	600	319428
	210	95	94	641	1100	125	530	NNF 5028
150	210	80	79	482	897	98	500	319430
	225	100	99	758	1272	141	500	NNF 5030
160	220	80	79	504	994	105	500	319432
	240	109	108	772	1390	152	430	NNF 5032
170	230	80	79	520	1040	108	500	319434
	260	122	121	1022	1780	191	430	NNF 5034
180	240	80	79	524	1080	112	440	319436
	280	136	135	1169	2090	225	400	NNF 5036
190	260	80	79	547	1170	119	400	319438
	290	136	135	1180	2160	232	400	NNF 5038
200	270	80	79	566	1230	123	400	319440
	310	150	149	1458	2860	296	400	NNF 5040
220	300	95	94	881	1850	185	340	322108
	340	160	159	1630	3060	311	320	NNF 5044
240	360	160	159	1677	3340	334	290	NNF 5048

Dimensions				Mass	Designation
d	r _{1,2min}	r _{3,4min}	r _{amax}		Standard design
[mm]				[kg]	
110	1,8	0,6	1,5	6,45	NNF 5022
120	1,8	0,6	1,5	6,9	NNF 5024
130	1,8	0,6	1	6,5	319110
	1,8	0,6	1,5	7,5	319426
	1,8	0,6	1,5	10,5	NNF 5026
140	1,8	0,6	1,5	8	319428
	1,8	0,6	1,5	11	NNF 5028
150	1,8	0,6	1,5	8,4	319430
	2	0,6	2	13,5	NNF 5030
160	1,8	0,6	1,5	8,8	319432
	2	0,6	2	16,5	NNF 5032
170	1,8	0,6	1,5	9,3	319434
	2	0,6	2	22,5	NNF 5034
180	1,8	0,6	1,5	9,8	319436
	2	0,6	2	30	NNF 5036
190	1,8	0,6	1,5	12,5	319438
	2	0,6	2	31,5	NNF 5038
200	1,8	0,6	1,5	13	319440
	2	0,6	2	42	NNF 5040
220	2	1	1	19,5	322108
	2	1	2	53,5	NNF 5044
240	2	1	2	57,5	NNF 5048

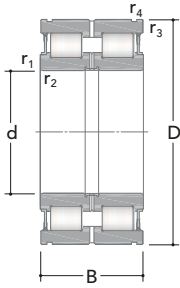

NNF (SL04)

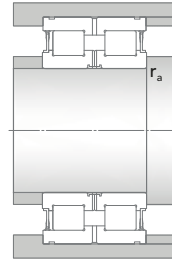

Main dimensions				Basic load ratings		Fatigue load limit	Speed ratings	Designation
d	D	B	C	Dynamic C	Static C ₀	C _u	Limiting	Standard design
[mm]				[kN]			[rpm]	
260	400	160	159	1918	3510	341	270	320848

Dimensions				Mass	Designation
d	r _{1,2min}	r _{3,4min}	r _{amax}		Standard design
[mm]				[kg]	
260	3	1,5	1,5	70	320848

Multi row cylindrical roller bearings

Multi row cylindrical roller bearings, also known as Multiroll, are made up of two parts: inner ring (L) and outer assembly (R), which includes outer rings, cage and four rows of rollers.

They are mainly used in rolling mill stands, where they are subjected to very high radial loads and impacts combined with medium-low speeds.

RKB Multiroll bearings are manufactured in different executions, to suit a wide range of applications and environments, above all in the harsh conditions of the steel and aluminum industry. May be available with a cylindrical bore for special design and applications as well as featuring tapered bore (taper 1:12) normally required as replacement for oil film bearings.



Multi row cylindrical roller bearings

Internal clearance

RKB multi row cylindrical roller bearings are usually manufactured in C3 or C4 radial internal clearance both typical in rolling mill application. Should the bearing be mounted loose fit on rolling mill neck, the radial clearance becomes

C2. Standard radial internal clearance for multi row cylindrical roller bearings with a cylindrical bore are provided in **Tab. 1 page 127**. For Multi row cylindrical roller bearings with a taper bore are usually produced with an internal clearance reported in **Tab. 2 page 128**.

Minimum load

A minimum radial load is requested for multi row cylindrical roller bearings to perform efficiently, especially in critical working conditions like: high speed, high acceleration and sudden changes of rotating direction. In these operating conditions, a skidding between rollers and raceways can be generated by the inertial forces, influencing negatively the bearing life. Assuming a continuous operation, the minimum radial load can be estimated using the following formula:

$$F_{rm} > \frac{C_{0r}}{50}$$

Where:

- F_{rm} minimum radial load, [kN];
- C_{0r} basic static load rating, [kN].

Usually, the minimum radial load is reached or surpassed by the weight of the components supported by the bearing together with the loads acting on it, otherwise supplementary radial load must be applied on the multi row cylindrical roller bearings. In application where a starting up at a low temperature is planned or a lubricant with high viscosity is used, a greater minimum radial load is required.

Bearing fittings

Multi row cylindrical roller bearings can be mounted on the roll neck both "tight fit" and "loose fit".

Typical "tight fit" values for roll neck can be found in the following **Tab. 6 page 241**.

Nominal bearing bore	Typical roll neck tolerance	
	Sup.	Inf.
[mm]	[mm]	
d < 200	n6	
200 <d ≤ 400	p6/r6	
400 <d ≤ 630	+0,200	+0,260
630 <d ≤ 800	+0,250	+0,330
900 <d ≤ 1250	+0,320	+0,420
1250 <d ≤ 1400	+0,400	+0,550
1400 <d ≤ 1600	+0,520	+0,650

Tab. 6 - General tight fit tolerances for roll neck

Viceversa, four row cylindrical roller bearings requesting an inner ring "loose fit", the roll neck typical tolerance is "e7".

As regards fitting tolerances for the chock bore, typical values are the following:

- "H6" for D ≤ 800 [mm]
- "H7" for D > 800 [mm]

With reference to four row cylindrical roller bearings featuring a tapered bore please consult the RKB application engineering services.

Designs and variants

Type AF2D/A2D

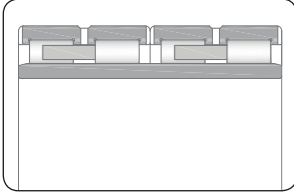

- Design used for small and medium size bearings
- One-piece ribless inner ring
- Two-piece outer ring with three integral ribs
- Double pronged high strength machined steel cage for increased stiffness and resistance to corrosive environments (AF2D)
- Annular groove and lubrication holes in outer ring
- Available with lubrication grooves in rings side faces
- Available with double pronged machined brass cage (A2D)

Type F2CII/EVO

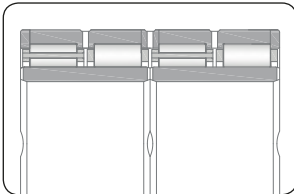

- Design used for large size bearings
- Two-piece ribless inner ring with lubrication grooves in side faces
- Two-piece outer ring with separated side flanges and one central spacer
- Two-piece pin-type steel cage with lightened design for optimized lubrication
- Pierced rollers design for increased carrying capacities
- Available with four window type machined brass cage (EVO)

Type Q2AC

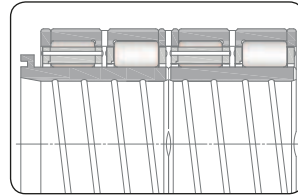

- Design used for large size bearings with increased shoulder on inner ring for seal seating
- Two-piece inner ring with lubrication grooves in side faces
- Two-piece outer ring with separated side flanges and one central spacer
- Four window type machined brass cage
- Annular groove and lubrication holes in outer ring

Type GB2DX

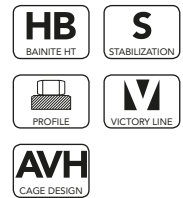
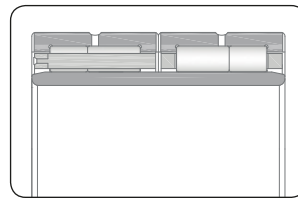

- Designed for rolling mill stands with automatic roll changing device
- One-piece ribless inner ring with increased length of chamfers to facilitate mounting
- Two-piece outer ring with integral ribs
- Two-piece reinforced window type machined brass cage with integral rivets (AVH) for optimized roller drop
- Long-short roller arrangement for better load distribution and reduced edge stress
- Optimized for oil lubrication and automatic grease lubrication systems

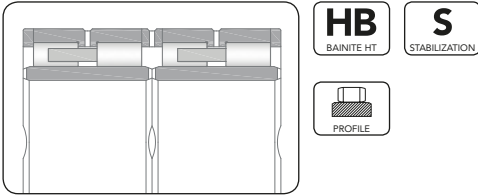
Type D2CII

- Design used for medium and large size bearings
- Two-piece ribless inner ring with lubrication grooves in side faces
- Two-piece outer ring with separated side flanges and one central spacer
- Double pronged machined brass cage
- Annular groove and lubrication holes in outer ring
- Design for facilitated mounting and dismounting

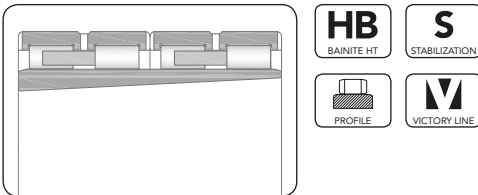
Special designs and variants**Type AF2D/A2D K/K30****Multi row cylindrical roller bearings with tapered bore**

RKB offers multi row cylindrical roller bearings both with 1:12 and 1:30 conicity depending on the bearing size. For additional information, please consult the RKB application engineering service.

Prefixes

L	In a separable bearing: separate inner ring
R	In a separable bearing: outer ring with roller and cage assembly
4CRB	Out of standard four-row cylindrical roller bearing followed by drawing number
NNU 60	Out of standard four-row cylindrical roller bearing followed by dimension indication

Note: unless differently specified, by default the mating of L and its corresponding R always give a C4 internal radial clearance

Suffixes

Main design

A	Two outer rings each with three integral ribs. One inner ring. Two double pronged machined brass cages guided on rolling elements
AF	As A, but with reinforced machined steel cage
B	As A, but with a spacer between the two outer rings
C or All	As A, but with inner ring split into two halves
CF	As C, but with reinforced machined steel cage
DII	Two outer rings each with an integral central rib and one loose flange ring; one spacer. One inner ring split into two halves. Two double pronged machined brass cages guided on rolling elements
EII	Two outer rings each with three integral ribs. One inner ring split into two halves. Four steel pin-type cages and pierced rollers
FII	Two outer rings each with an integral central rib and one loose flange ring; one spacer. One inner ring split into two halves. Four steel pin-type cages and pierced rollers
FIIEVO	As FII, but with four window type machine brass cages
GII or GXII	Two outer rings each with two integral ribs. One inner ring split into two halves. Two double row window type machined brass cages
GB or GBX	As GII, but with one inner ring in one piece (not split)
H	One outer ring with three loose guide rings and two loose flange rings. One inner ring. Two double pronged machined brass cages
I	Two outer rings each with integral central rib and two loose flange rings; one spacer. Two inner rings. Four pressed steel cages
L	One outer ring with five integral ribs. One inner ring. Four pronged machined brass cages guided on rolling elements
M	As C, but with one wider inner ring
N	As D, but with one wider inner ring
O	As F, but with one wider inner ring
P	As H, but with one wider inner ring
Q	As F, but with one wider inner ring with concentric shoulder
R	As F, but with two wider inner rings; one inner ring with concentric shoulder
VJ 202	Bearing set of two double row bearings

Suffixes

Internal design

ZB	Optimized roller profile for improved load distribution. It is not necessarily stated in the bearing code
SP	Special or non-standard bearing
W	One wider inner ring
WS	One wider inner ring with special concentric shoulder

Suffixes	Cage
S/F	Steel cage

Suffixes	Accuracy, clearance, running
HP	High precision running accuracy (better than P6)

Suffixes	Lubrication
1	Annular groove and lubrication holes in spacer between outer rings
2	Annular groove and lubrication holes in outer rings
3	Annular groove and lubrication holes in spacer between outer rings and Annular groove and lubrication holes in outer rings
A	Helical groove in inner ring bore
B	Scallops in the side faces of inner and outer rings
C	Scallops in the side face of inner ring
D	Scallops in the side face of outer ring

Suffixes	External design
K	Tapered bore, taper 1:12
K30	Tapered bore, taper 1:30

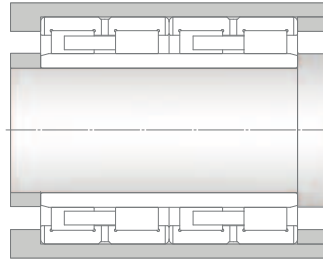
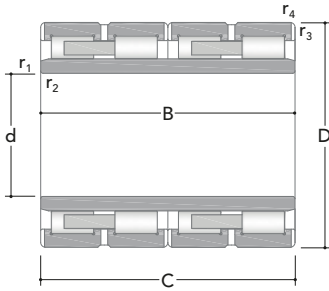

AF2D/A2D

Main dimensions				Basic load ratings		Fatigue load limit	Designation	
d	D	B	C	Dynamic C	Static C ₀	C _u	Cylindrical bore	
[mm]				[kN]				
115	165	107,5	90	401	760	87	319738	
127	174,625	150,812	150,812	624	1310	152	315643	
139,7	215	195	187	1020	2260	258	466971	
	215	195	187	1218	2530	288	459696	
145	210	155	155	800	1550	172	314625	
	225	156	156	906	1650	182	313924	
150	230	156	156	894	1640	181	313891	
160	230	130	130	773	1330	142	314190	
	230	168	168	1100	2180	238	315189	
	233	180	180	1147	2760	311	457627	
165,1	225,425	168,275	168,275	1012	2210	237	315642	
170	230	130	130	678	1390	145	313673	
	230	160	160	1088	2350	254	322340	
	240	130	130	912	1857	199	635122	
	260	225	225	1658	3320	352	313587	
180	260	168	168	1400	2470	262	313812	
	190	260	168	168	1128	2590	269	313651
		270	200	200	1500	3320	342	314199
280	200	200	1726	3320	342	314049		
200	270	170	170	1225	2690	274	314553	
	280	170	170	1441	2990	304	314385	
	280	170	170	1421	3136	322	314385 GB2	
	280	180	170	1365	2970	302	319019	

⁽¹⁾ Bearing set of two double row bearings (Suffix VJ 202)

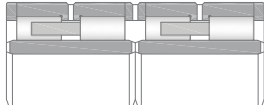

D2C

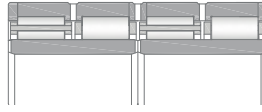

F2CII/EVO

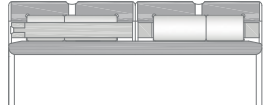

GB2

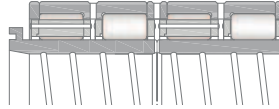

Q2AC

Dimensions			Mass	Designation
d	r _{1,2min}	r _{3,4min}		Cylindrical bore
[mm]			[kg]	
115	1,1	1,1	8,5	319738
127	1,1	1,5	10,5	315643
139,7	3	0,4	25	466971
	3	0,4	24	459696
145	1,1	1,1	18	314625
	2	2	23	313924
150	2	2	24	313891
160	1,5	1,5	17	314190
	2	2	23,5	315189
	2,5	1,8	26,5	457627
165,1	1,5	1,5	20	315642
170	2	2	15	313673
	2	2	19	322340
	2	2	19	635122
	2,1	2,1	43,5	313587
180	2,1	2,1	29,5	313812
190	2	2	27	313651
	2,1	2,1	37,5	314199
	2,1	2,1	41,5	314049
200	2,1	2,1	28,5	314553
	2,1	2,1	33,5	314385
	2,1	2,1	35	314385 GB2
	2,1	2,1	35	319019

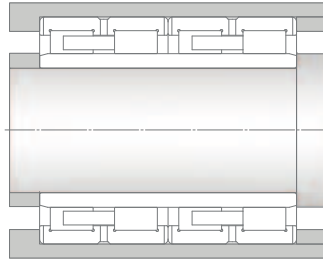
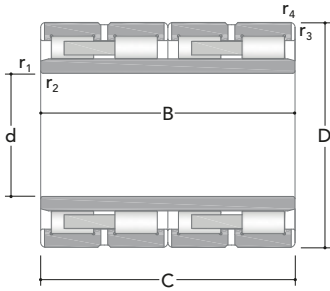

AF2D/A2D

Main dimensions				Basic load ratings		Fatigue load limit	Designation
d	D	B	C	Dynamic C	Static C ₀	C _u	Cylindrical bore
[mm]				[kN]			
200	280	200	200	1492	3353	345	313893
(cont.)	285	200	200	1466	3840	399	457628
	290	192	192	1526	3190	319	313811
	310	230	230	2038	3730	388	313639 ⁽¹⁾
210	290	192	192	1460	3390	354	313646
220	300	200	200	1793	3823	382	322341
230	330	206	206	2008	3920	382	313824
	365	250	250	2657	4890	489	313581
240	330	180	180	1739	3770	372	635194
	330	220	220	1711	4322	417	313921
	330	240	220	1709	4260	411	320415
	360	290	290	3262	6500	635	322292
250	340	230	230	1878	4920	502	457629
260	360	204	204	1983	4360	421	314997
	360	230	230	2008	4580	448	320956
	370	220	220	2170	4570	457	313823
	370	240	220	2185	4540	458	319464
	400	290	290	3521	6980	669	313427
265	370	234	234	2216	5330	513	313922
270	380	295	275	3121	7140	689	315605
280	390	220	220	2416	4960	486	313822
	390	250	220	2227	4900	480	319259
	390	275	275	3106	7130	688	314719
	400	285	285	3182	7280	703	314070 ⁽¹⁾

⁽¹⁾ Bearing set of two double row bearings (Suffix VJ 202)

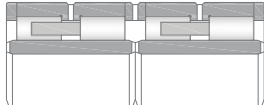

D2C

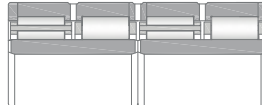

F2CII/EVO

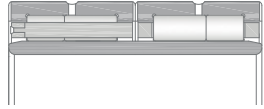

GB2

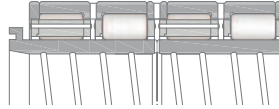

Q2AC

Dimensions			Mass	Designation
d	r _{1,2min}	r _{3,4min}		Cylindrical bore
[mm]			[kg]	
200	0,6	2,1	39	313893
(cont.)	2,1	2	44	457628
	2,1	2,1	42,5	313811
	2,1	2,1	63	313639 ⁽¹⁾
210	2,1	2,1	41	313646
220	2,1	2,1	41	322341
230	2,1	2,1	58	313824
	3	3	100	313581
240	2,1	2,1	49,5	635194
	2,1	2,1	58	313921
	2,1	2,1	60	320415
	8x20°	2	130	322292
250	3	2,3x45°	65	457629
260	2,1	2,1	64,5	314997
	3	3	73,5	320956
	3	3	77,5	313823
	3	3	78,5	319464
	4	4	135	313427
265	3	3	80,5	313922
270	2	1	100	315605
280	3	3	82,5	313822
	3	3	84,5	319259
	7x20°	1,1	100	314719
	3	3	120	314070 ⁽¹⁾

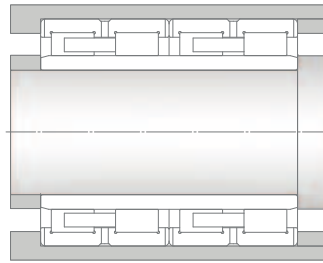
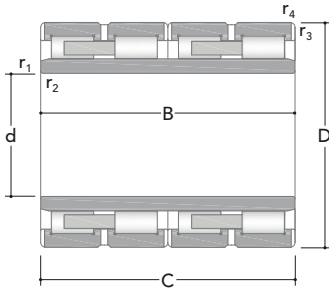

AF2D/A2D

Main dimensions				Basic load ratings		Fatigue load limit	Designation
d	D	B	C	Dynamic C	Static C ₀	C _u	Cylindrical bore
[mm]				[kN]			
280	410	300	300	3493	7470	732	314897
(cont.)	420	300	300	3506	7260	686	313487
290	390	190	190	2060	4530	438	635195
300	420	300	300	4013	8670	837	314484
	420	320	300	3739	8680	838	319129
320	460	240	240	2939	7160	666	322216
	480	350	350	5017	10750	961	314274
330	460	340	340	4443	10080	939	313445
340	480	350	350	4900	10990	1019	314485
	480	370	350	4605	10890	1010	319040
	500	370	370	5274	11680	1069	322261
	560	380	380	6749	12820	1073	313404
350	500	380	380	4972	11270	1028	314563
	500	410	410	5816	13670	1197	322777
	520	300	300	4350	8920	793	319878
	520	300	300	4350	8920	793	326909
	520	320	300	4350	8920	789	326858
360	500	250	250	3599	7270	663	320075
	500	250	250	3506	8350	766	322217
	510	400	380	5283	12090	1090	316890
370	520	380	380	5468	12970	1140	314486
380	540	260	260	3426	8630	763	326131
	540	300	300	5008	10800	947	313030
	540	400	380	6126	13800	1183	320989

⁽¹⁾ Bearing set of two double row bearings (Suffix VJ 202)

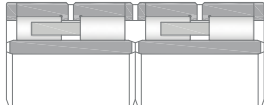

D2C

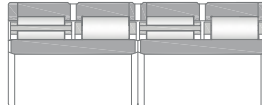

F2CII/EVO

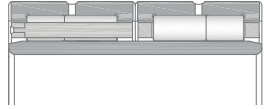

GB2

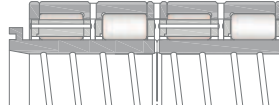

Q2AC

Dimensions			Mass	Designation
d	r _{1,2min}	r _{3,4min}		Cylindrical bore
[mm]			[kg]	
280	4	4	130	314897
(cont.)	4	4	150	313487
290	2,1	2,1	67	635195
300	7x20°	1,5	130	314484
	4	1,5	135	319129
320	3	3	140	322216
	10x20°	1,5	220	314274
330	10,5x20°	1,5	175	313445
340	8x20°	1,5	205	314485
	4	1,5	200	319040
	13x20°	3	260	322261
	5	4	350	313404
350	5	5	240	314563
	11,5x20°	3	285	322777
	5	5	220	319878
	8x20°	5	220	326909
	8x20,5°	5	240	326858
360	3	3	145	320075
	3	3	140	322217
	4	1,5	260	316890
370	10x20°	1,5	255	314486
380	4	4	205	326131
	8,5x20°	2	220	313030
	4	1,5	300	320989

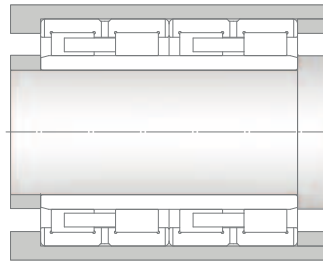
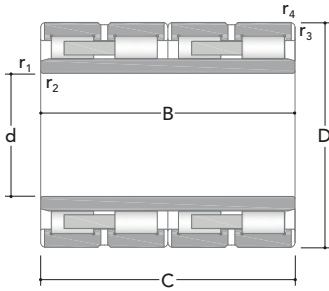

AF2D/A2D

Main dimensions				Basic load ratings		Fatigue load limit	Designation
d	D	B	C	Dynamic C	Static C ₀	C _u	Cylindrical bore
[mm]				[kN]			
380	540	400	380	5771	13480	1141	315606
(cont.)	540	400	400	5845	13950	1216	313511
	540	400	400	6116	14940	1285	326366
	560	300	300	4995	9510	838	322189
	560	325	325	5181	10540	925	322264
390	540	320	320	5258	12010	1024	322498
	550	310	310	5155	11120	993	313190
399,93	590	440	440	8645	20060	1701	313038
400	560	410	410	6299	15330	1297	313015
	590	440	440	7267	16330	1377	315802
410	560	400	400	6393	15920	1363	316689
	560	400	400	5508	15920	1363	322038
	560	420	400	6002	14320	1226	320612
	600	440	440	7669	17120	1514	313877
420	580	260	260	3791	9630	828	320074
	580	320	320	4658	10770	947	313555
	600	440	440	7189	17520	1453	313513
	620	400	400	6948	15490	1281	314391
431,5	571,5	300	300	4412	10086	870	326361
440	620	450	450	7919	19310	1576	314554
	620	470	450	7203	17270	1433	320608
	650	355	355	6715	13770	1062	316899
	660	340	340	6628	13650	1076	635043
447,295	635,176	463,55	463,55	8263	19690	1605	314792

⁽¹⁾ Bearing set of two double row bearings (Suffix VJ 202)

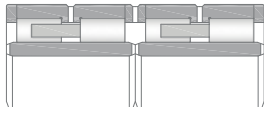

D2C

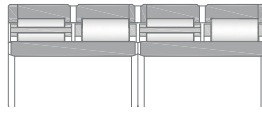

F2CII/EVO

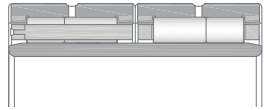

GB2

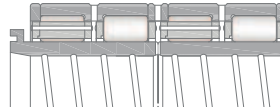

Q2AC

Dimensions			Mass	Designation
d	r _{1,2min}	r _{3,4min}		Cylindrical bore
[mm]			[kg]	
380	4	1,5	295	315606
(cont.)	10x20°	2	295	313511
	10x20°	2	305	326366
	13,5x20°	2	260	322189
	13,5x20°	5	265	322264
390	10x20°	2	230	322498
	11x20°	4	240	313190
399,93	10x20°	5	420	313038
400	13,5x20°	2	315	313015
	5	5	415	315802
410	11x20°	2	290	316689
	14x20°	2	295	322038
	13x20°	2	275	320612
	5	5	425	313877
420	4	4	210	320074
	4	4	250	313555
	8x20°	2	400	313513
	4	4	430	314391
431,5	10,5x20°	4	210	326361
440	12x20°	2	440	314554
	14x20°	2	420	320608
	12,5x20°	4	420	316899
	6	6	430	635043
447,295	13,5x20°	5	460	314792

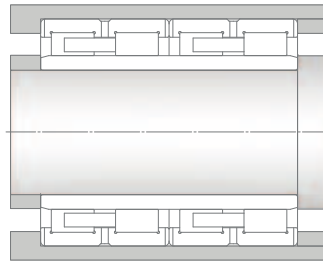
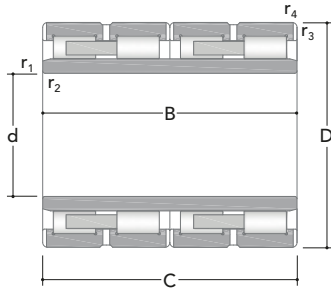

AF2D/A2D

Main dimensions				Basic load ratings		Fatigue load limit	Designation
d	D	B	C	Dynamic C	Static C ₀	C _u	Cylindrical bore
[mm]				[kN]			
450	590	300	300	3861	11930	1014	315811
459,95	760	600	600	14101	30390	2312	312980
460	650	355	355	6301	14420	1205	313031
	650	424	424	7905	18160	1518	315196
	650	460	424	7892	17980	1503	322993
	650	470	470	8931	22270	1889	314560
	650	470	470	8931	22270	1889	319155
	680	400	400	8032	17080	1323	322374
475	600	368	368	5516	14590	1249	326261
480	650	450	450	8176	20780	1666	316690
	680	420	420	8328	19070	1482	319320
	680	500	500	9231	21650	1673	316624
	680	500	500	9639	23530	1892	313516
487,98	637,045	350	350	5078	15170	1210	326196
500	650	260	260	4064	10090	806	319254
	670	450	450	8148	21970	1798	316083
	670	480	450	8372	21880	1790	322039
	680	450	450	8218	21610	1729	316515
	710	480	480	8813	21460	1619	316968
	720	400	400	7846	17570	1318	322066
	720	530	530	10765	28000	2083	314441
	738	500	500	10657	23030	1747	326853
510	680	500	500	8861	25480	1960	319411
529,91	870	670	670	15665	33400	2443	312844

⁽¹⁾ Bearing set of two double row bearings (Suffix VJ 202)

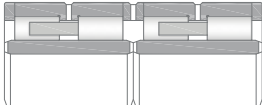

D2C

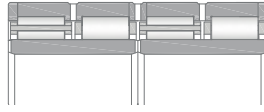

F2CII/EVO

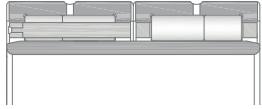

GB2

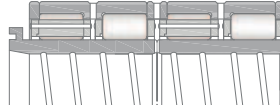

Q2AC

Dimensions			Mass	Designation
d	r _{1,2min}	r _{3,4min}		Cylindrical bore
[mm]			[kg]	
450	12x45°	4	245	315811
459,95	15x20°	6	1160	312980
460	12x20°	3	380	313031
	12x20°	3	450	315196
	12x20°	3	490	322993
	12x20°	3	510	314560
	3	3	510	319155
	6	6	640	322374
475	3	3	235	326261
480	12,5x20°	2	440	316690
	12x20°	3	515	319320
	13x20°	3	605	316624
	13x20°	3	585	313516
487,98	10,5x20°	4	300	326196
500	5	5	225	319254
	12,5x20°	5	460	316083
	12,5x20°	5	485	322039
	5	2	500	316515
	18x20°	5	610	316968
	6	3	530	322066
	13x20°	5	730	314441
	1E0(20°	6	735	326853
510	7,5x20°	5	522	319411
529,91	7,5	7,5	1660	312844

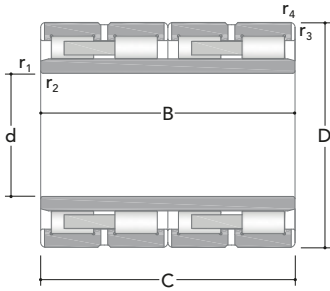

AF2D/A2D

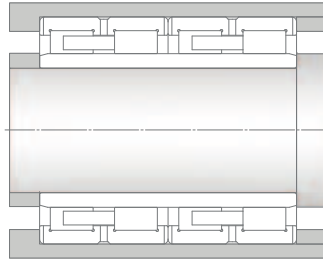

Main dimensions				Basic load ratings		Fatigue load limit	Designation
d	D	B	C	Dynamic C	Static C ₀	C _u	Cylindrical bore
[mm]				[kN]			
530	760	520	520	11621	28120	2092	314886
	780	500	500	9365	20030	1502	315040
	780	570	570	12646	31970	2361	314517
536,176	762,03	558,8	558,8	11449	28540	2126	313535
	762,03	558,8	558,8	11083	29470	2161	322142
549,85	740	510	510	10191	26690	2214	326897
550	740	510	510	10204	26570	2204	316691
	800	520	520	11667	26160	1935	316115
	800	560	560	12048	27580	2009	322719
559,84	920	710	710	20344	44600	3186	313189
560	820	600	600	14149	33720	2430	322930
571,1	812,97	594	594	13593	33120	2521	313499
580	780	521	486	9932	26990	2039	326140
600	820	575	575	13832	35790	2535	315175
	870	540	540	13137	31330	2228	315068
	870	578	540	13203	31440	2236	322497
	870	640	640	14957	39700	2829	314317
	870	640	640	15690	39700	2829	315513
610	820	430	430	9394	23430	1688	315257
628	922	600	600	16719	38640	2675	315071
634,5	901,87	674	674	16762	44480	3114	313705

⁽¹⁾ Bearing set of two double row bearings (Suffix VJ 202)

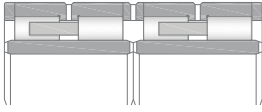

D2C

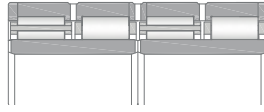

F2CII/EVO

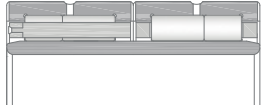

GB2

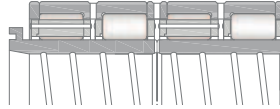

Q2AC

Dimensions			Mass	Designation
d	r _{1,2min}	r _{3,4min}		Cylindrical bore
[mm]			[kg]	
530	12x20°	5	775	314886
	6	6	805	315040
	14x20°	3	960	314517
536,176	16x20°	4	830	313535
	16x20°	4	820	322142
549,85	15x20°	2	615	326897
550	15x20°	2	615	316691
	10x20°	6	895	316115
	18,5x20°	6	930	322719
559,84	20x20°	4	2000	313189
560	20x20°	3	1080	322930
571,1	14x20°	5	1000	313499
580	12x20°	2	700	326140
600	15x20°	3	910	315175
	22x20°	4	1100	315068
	19,5x20°	4	1150	322497
	17x20°	4	1300	314317
	20x20°	4	1340	315513
610	19x20°	3	650	315257
628	17,5x20°	6	1420	315071
634,5	18x20°	4	1400	313705

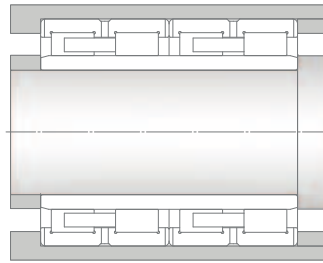
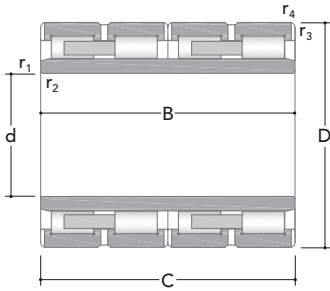

AF2D/A2D

Main dimensions				Basic load ratings		Fatigue load limit C_u	Designation Cylindrical bore
d	D	B	C	Dynamic C	Static C_0		
[mm]				[kN]			
650	920	670	670	17334	46250	3183	313007
658	1075	650	650	20521	42820	2888	320525
660	820	440	440	7442	22500	1609	239509
	880	450	450	7260	23200	1730	313477
680	980	640	640	17012	43510	2967	313154
690	980	715	715	19748	53780	3635	313008
700	930	620	620	15032	42700	2979	316967
710	1000	715	715	19988	54900	3676	313403
730	960	620	620	15492	44920	2995	315982
	1030	750	750	20674	57760	3851	314518
748	1135	690	690	21920	50880	3342	420625
750	1000	500	500	12356	32950	2203	314420
	1000	670	670	17550	49260	3300	315973
759	1210	740	740	26985	83980	3754	313685
760	1080	790	790	23944	64730	4348	312979
761,425	1079,602	787,4	787,4	23589	65310	4387	312967
	1079,602	787,4	787,4	23471	65330	4389	322143
799	1080	700	700	20060	57610	3742	326892
800	1080	700	700	19565	58060	3771	315599

⁽¹⁾ Bearing set of two double row bearings (Suffix VJ 202)

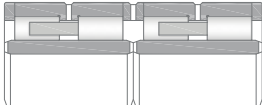

D2C

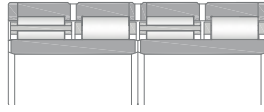

F2CII/EVO

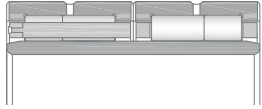

GB2

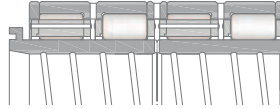

Q2AC

Dimensions			Mass	Designation
d	r _{1,2min}	r _{3,4min}		Cylindrical bore
[mm]			[kg]	
650	17x20°	4	1450	313007
658	22x20°	75	2490	320525
660	7,5	4	530	239509
	6	6	785	313477
680	20x20°	4	1590	313154
690	20x20°	4	1780	313008
700	18x20°	3	1180	316967
710	17x20°	4	1860	313403
730	20x20°	3	1220	315982
	21x20°	6	2040	314518
748	21x20°	4	2635	420625
750	6	6	1150	314420
	20x20°	3	1480	315973
759	4	4	3480	313685
760	7,5	7,5	2440	312979
761,425	19x20°	7,5	2400	312967
	19x20°	75	2410	322143
799	20x20°	3	1955	326892
800	20x20°	3	1950	315599

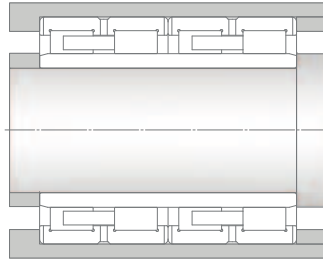
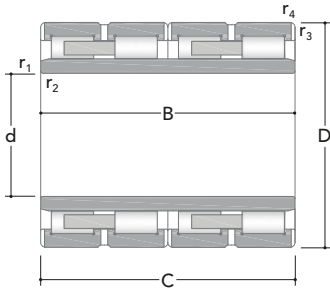

AF2D/A2D

Main dimensions				Basic load ratings		Fatigue load limit	Designation
d	D	B	C	Dynamic C	Static C ₀	C _u	Cylindrical bore
[mm]				[kN]			
820	1100	745	720	19593	56190	3697	316341
	1130	800	800	24143	67600	4374	320455
	1130	825	800	24339	66900	4329	319313
850	1150	840	840	25292	74630	4776	315826
862,98	1219,302	876,3	889	30121	85370	5428	312966
865	1180	750	750	23081	66020	4237	319668
900	1220	840	840	28582	78970	4936	316043
	1280	930	930	32974	91670	5914	313528
937,5	1270,25	825,5	825,5	28122	82070	5241	315265
950	1360	975	975	34207	98550	6110	319862
	1360	1000	1000	37911	109500	6769	314520
980	1310	880	880	28900	84840	5296	319303
1000	1360	800	800	27757	82950	5097	316234
1200	1590	1050	1050	41830	132600	7916	315494

⁽¹⁾ Bearing set of two double row bearings (Suffix VJ 202)

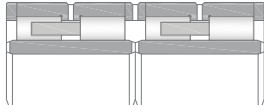

D2C

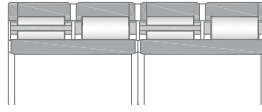

F2CII/EVO

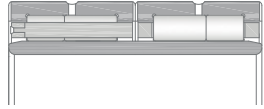

GB2

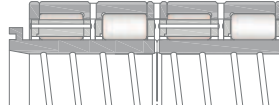

Q2AC

Dimensions			Mass	Designation
d	r _{1,2min}	r _{3,4min}		
[mm]			[kg]	Cylindrical bore
820	22x20°	3	2000	316341
	23x20°	6	2540	320455
	23x20°	6	2570	319313
850	23x20°	4	2570	315826
862,98	7,5	4	3470	312966
865	20x20°	8,5x45°	2520	319668
900	24x24°	4	3060	316043
	25x20°	4	4080	313528
937,5	27x20°	4	3160	315265
950	26x20°	6	4900	319862
	22x20°	5	5020	314520
980	20x20°	14x45°	3310	319303
1000	23x20°	4	3560	316234
1200	30x20°	6	5970	315494

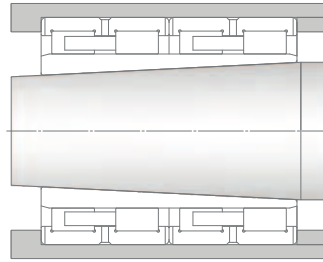
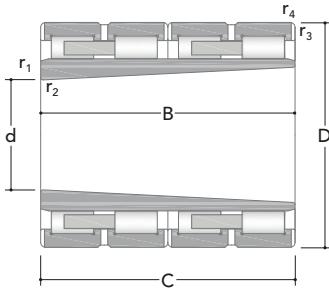

AF2D/A2D K/K30

Main dimensions				Basic load ratings		Fatigue load limit	Designation
d	D	B	C	Dynamic C	Static C ₀	C _u	Tapered bore
[mm]				[kN]			
105	150	71	71	256	472	52	319148
125	180	100	90	428	863	94,6	319768
140	210	155	155	798	1530	173	313900
151,5	230	168	168	1042	2190	239	314024
	230	168	168	1090	2270	249	467334
160	240	175	175	1188	2510	271	313436
160,69	260	178,7	166	1089	2520	272	466949
162	230	130	130	664	1382	144	312863
170	260	160	160	1086	2120	224	313423
175	260	180	180	1223	3120	337	457919
181	260	180	180	1132	2600	270	314874
	260	180	180	969	2580	278	452683
181,5	260	168	168	1133	2530	258	314023
	260	168	168	956	2590	279	467333
182	260	168	183	1136	2570	267	312942
183,33	280	200	200	1383	3430	373	457920
190	280	200	200	1491	3320	342	313583
	290	180	180	1444	2800	285	313422
192	270	170	170	1225	2690	272	313153

Dimensions			Mass	Designation
d	r _{1,2min}	r _{3,4min}		Tapered bore
[mm]			[kg]	
105	0,6	1,1	4,1	319148
125	1	1,5	7,9	319768
140	1,1	1,1	17	313900
151,5	1,1	2	24	314024
	2	2x45°	23	467334
160	1	2	24	313436
160,69	2,1	1,2x45°	34	466949
162	1	2	16	312863
170	0,6	1,1	29,5	313423
175	1	1,8x45°	32	457919
181	2	2	29,5	314874
	1	3,5x45°	28	452683
181,5	1,1	2	27,5	314023
	1,5	1x45°	27	467333
182	1	2	28	312942
183,33	1,5	2x45°	43	457920
190	1,1	2,1	40	313583
	1	2,1	41	313422
192	1	2,1	28,5	313153

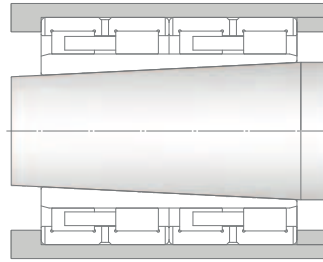
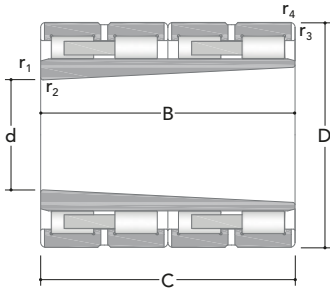

AF2D/A2D K/K30

Main dimensions				Basic load ratings		Fatigue load limit	Designation
d	D	B	C	Dynamic C	Static C ₀	C _u	Tapered bore
[mm]				[kN]			
200,833	310	230	230	1880	4700	485	457922
202	290	192	192	1429	3360	351	313152
	290	202,23	192	1305	3580	378	467419
	290	207	192	1456	3350	350	312858
205	310	225	225	1940	4230	423	313584
228,33	325	200	200	1599	4480	468	461839
230	330	220	220	2016	4590	459	313438
231	330	235	220	1736	4310	416	312943
246,67	380	280	280	2670	7050	665	457927
255	370	249	234	2222	5380	518	312860
260	400	250	250	2718	5760	551	313439
	400	285	285	3127	7290	704	313532
266,25	400	285	285	2545	6680	629	457929
320	480	350	350	4553	10930	1014	316345
340	520	300	300	4271	8870	788	315767
356,67	550	400	400	5226	14780	1271	457939
365	540	300	300	5079	10790	947	313041
382,5	590	450	450	6915	15980	1402	319352

Dimensions			Mass	Designation
d	r _{1,2min}	r _{3,4min}		Tapered bore
[mm]			[kg]	
200,833	3	3,2x45°	62,5	457922
202	1	2,1	39,5	313152
	1,5	2,5x45°	49	467419
	1	2,1	42,5	312858
205	1,1	3	58	313584
228,33	1	2	48,5	461839
230	1,1	2,1	57,5	313438
231	1,1	2,1	59	312943
246,67	3	2,8x45°	115	457927
255	1,1	3	82	312860
260	1,1	3	110	313439
	1,1	3	125	313532
266,25	4	3,2x45°	120	457929
320	1,5	1,5	215	316345
340	2	5	215	315767
356,67	3,2	4x45°	335	457939
365	2	2	230	313041
382,5	5	6,4x45°	425	319352

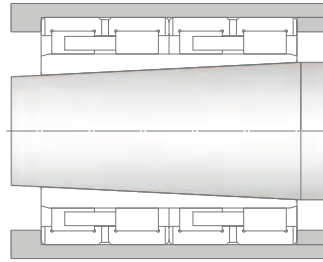
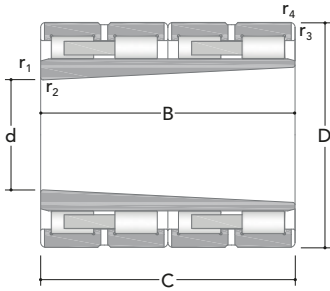

AF2D/A2D K/K30

Main dimensions				Basic load ratings		Fatigue load limit	Designation
d	D	B	C	Dynamic C	Static C ₀	C _u	Tapered bore
[mm]				[kN]			
412,335	650	488	480	7530	21000	1714	467373
	650	488	488	8518	18660	1473	314964
412,5	630	450	450	6689	18760	1580	457945
440	650	355	355	6281	14540	1215	313032
485	740	540	540	10853	28150	2133	315523
511,584	760	560	580	11848	34290	2214	457956
551,667	830	580	580	12223	32170	2296	457960
571,627	870	640	640	13529	40070	2869	319446
571,667	870	640	640	17852	49430	3510	457962
606,667	920	640	640	16711	44660	3077	315526
633,334	960	680	680	14468	44330	3103	457969
773,334	1120	800	800	23510	64650	4244	319991
811,692	1180	850	850	25442	66860	4326	457984
918,354	1330	950,125	950	26633	84380	5361	457995
950	1360	1000	1000	37600	109500	6769	314520

Dimensions			Mass	Designation
d	r _{1,2min}	r _{3,4min}		Tapered bore
[mm]			[kg]	
412,335	5	4,5x45°	565	467373
	4	4	575	314964
412,5	1,5	4,5x45°	490	457945
440	3	3	400	313032
485	5	5	830	315523
511,584	3	5,8x45°	915	457956
551,667	3	6,1x45°	1070	457960
571,627	3	4	1335	319446
571,667	4	6,4x45°	1170	457962
606,667	4	5	1525	315526
633,334	4	6,4x45°	1675	457969
773,334	4	8,5x45°	2715	319991
811,692	1,5	8,5x45°	2980	457984
918,354	6	6x45°	4380	457995
950	4	5	4830	314520



Tapered roller bearings

Tapered roller bearings	272
Single row tapered roller bearings.....	272
Axial Internal clearance and preload.....	272
Adjustment and running in	272
Misalignment.....	274
Minimum load	274
Cage	274
Designs and variants	275
Type TS.....	275
Type DB	275
Type DF	275
Suffixes.....	276
Part numbering.....	277
Inch size.....	277
Metric size	280
Product tables.....	282
Product tables.....	306
Double row tapered roller bearings	350
Tolerances and accuracy	350
Axial internal clearance	350
Misalignment.....	350
Minimum load.....	350
Designs and variants	351
Type TDO.....	351
Type TDI	351
Type TDONASW.....	351
Type TDIS with steep contact angle	351
Type TDISS with steep contact angle	352
Type TDIS with retention sleeve.....	352
Type TDISS with retention sleeve.....	352
Suffixes.....	353
Part numbering.....	354
First system	354

Second system.....	356
Product tables.....	358
Product tables.....	378
Product tables.....	390
Product tables.....	394
Four-row tapered roller bearings.....	396
Bearing internal clearance.....	396
Minimum load.....	396
Bearings fitting.....	396
Designs and variants.....	398
Type TQO ₁	398
Type TQO ₂	398
Type TQO ₃	398
Type TQOE.....	398
Type SET2xTDI.....	399
Type TQI.....	399
Type TQIT.....	399
Type TQITE.....	399
Type TQOT.....	400
Type TQOS ₁	400
Type TQOS ₂	400
Type TQOS ₃	400
Type TQOES.....	401
Suffixes.....	402
Part numbering.....	404
First system.....	404
Second system.....	406
Product tables.....	408

RKB
BEARING INDUSTRIES
SWITZERLAND

Tapered roller bearings

The tapered roller bearings manufactured by RKB are engineered to withstand combined radial and thrust loads. Available in a rich portfolio of designs and sizes, in standardized and non-standardized dimensional series, RKB tapered roller bearings can be in metric or inch measurements and represent the state of the art. Manufactured from high hardness materials, featuring unparalleled fatigue strength and resistance to wear, RKB TRBs provide excellent performance even under severe operating conditions.

RKB's single row, matched pair, double and four-row tapered roller bearings are optimized to ensure increased load carrying capacities and high stiffness in special applications. RKB Bainite Hardening Treatment (HB) and High Temperature Dimensional Stabilization (S) can be applied on bearing rings and rollers.

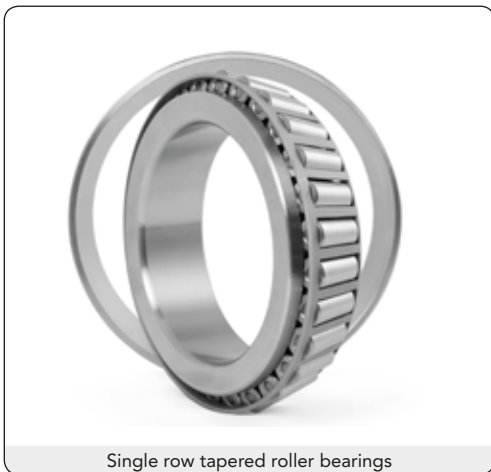

Single row tapered roller bearings

RKB single row and matched pair tapered roller bearings (SRTRBs) are widely used in all industrial segments, in standard and critical applications. The tighter dimensional tolerances, obtained through an extremely high precision manufacturing technology, and the optimized inner geometry (E-Type class) make of such bearings a reliable solution to improve the performance of any machine. Naturally, the matched pairs can be assembled according to the customer's special needs (e.g. a given axial internal clearance). The bearing dimensional and running accuracy conforms to ISO/ABMA/GOST specifications.

Axial Internal clearance and preload

The internal axial load or preload of the single row taper roller bearing can be obtained only during the mounting by adjusting one bearing against to the second one, which guarantees the location on the opposite side.

For standard internal clearance of paired metric single row tapered roller bearings in face-to-face or back-to-back arrangement please see **Tab. 1 page 273**.

Adjustment and running in

Before adjusting the taper roller bearings against each other, it is mandatory to rotate them in order to permit the rollers to find their final position. During the running-in, the working temperature of the taper roller bearings will increase rapidly due to the high frictional moment, but when the running-in period will be completed the temperature becomes stable and the thermal equilibrium takes place.

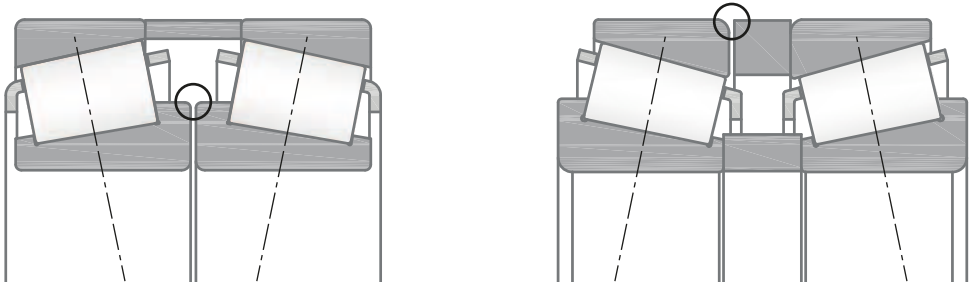

Bore diameter		Axial internal clearance of matched bearings in the series											
d		329		320		330		331, 302, 322, 332		303, 323		313	
over	incl.	high	low	high	low	high	low	high	low	high	low	high	low
[mm]		[µm]											
-	30	-	-	80	120	-	-	100	140	130	170	60	100
30	40	-	-	100	140	-	-	120	160	140	180	70	110
40	50	-	-	120	160	180	220	140	180	160	200	80	120
50	65	-	-	140	180	200	240	160	200	180	220	100	140
65	80	-	-	160	200	250	290	180	220	200	260	110	170
80	100	270	310	190	230	350	390	210	270	240	300	110	170
100	120	270	330	220	280	340	400	220	280	280	340	130	190
120	140	310	370	240	300	340	400	240	300	330	390	160	220
140	160	370	430	270	330	340	400	270	370	370	430	180	240
160	180	370	430	310	370	-	-	310	370	390	450	-	-
180	190	370	430	340	400	-	-	340	400	440	500	-	-
190	200	390	450	340	400	-	-	340	400	440	500	-	-
200	225	440	500	390	450	-	-	390	450	490	550	-	-
225	250	440	500	440	500	-	-	440	500	540	600	-	-
250	280	540	600	490	550	-	-	490	550	-	-	-	-
280	300	640	700	540	600	-	-	540	600	-	-	-	-
300	340	640	700	590	650	-	-	590	650	-	-	-	-

Tab. 1 - Axial internal clearance of paired metric single row tapered roller bearings in face-to-face or back-to-back arrangement

Misalignment

The permissible misalignment between the shaft and seat of the single row tapered roller bearing is restricted to a few minutes of arc, approximately from 2 to 4 minutes of arc.

These values can be considered valid if the shaft and housing axes remain unchanged. Larger values of misalignment may be used, but with negative consequences regarding the bearing life. For additional information, please consult the RKB application engineering service.

Minimum load

A minimum radial load is requested for single tapered roller bearings, like for all ball and roller bearings, in order to guarantee an adequate operation condition, especially in critical working conditions: high speed ($n > 0.5$ reference speed), high acceleration and sudden changes of rotating direction. In these operating conditions a sliding movement between the rollers and raceways can be generated by the inertial forces, influencing negatively the bearing life. Minimum radial load can be calculated using the following formula:

$$\frac{F_{rm}}{C_r} > 0,02$$

Where

- F_{rm} minimum radial load, [kN];
- C_r basic dynamic radial load, [kN].

Usually, the minimum radial load is reached or surpassed by the weight of the components supported by the bearing and the loads acting on it, otherwise supplementary radial load must be applied on the single row tapered roller bearing. In application where a starting up at low temperature is planned or a lubricant with high viscosity is used, a greater minimum radial load is required.

Cage

RKB single row tapered roller bearings feature one-piece window type pressed steel cage guided on rollers. In order to mount correctly the bearings, it is recommended to keep a proper space to host laterally the cage protrusions. For additional informations please consult the RKB application engineering services.

Designs and variants

Type TS

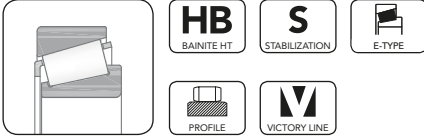

- Ribless outer ring (cup)
- Inner ring with two integral ribs (cone)
- One-piece window type pressed steel cage
- Supports radial and axial loads in one direction
- Suitable for medium to high operating speeds
- Separable design
- Optimized geometry (E-Type)
- Optimized roller profile
- Available in metric and inch sizes

Type DF

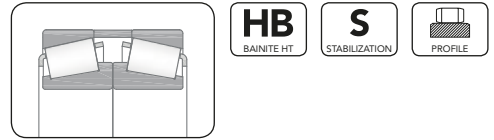

- Matched set of single row TRBs (face-to-face arrangement)
- Available with cup and cone spacers (plain or with lubrication holes)
- Supports radial and axial loads in both directions
- Low arrangement stiffness
- Increased angular misalignment
- Optimized geometry (E-Type)
- Optimized roller profile
- Preset or adjusted BEP on customer's request
- Available in metric and inch sizes

Type DB

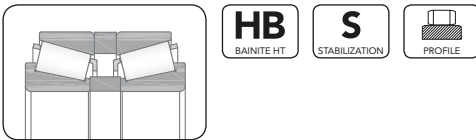

- Matched set of single row TRBs (back-to-back arrangement)
- Available with cup and cone spacers (plain or with lubrication holes)
- Supports radial and axial loads in both directions
- High arrangement stiffness
- Reduced angular misalignment
- Optimized geometry (E-Type)
- Optimized roller profile
- Preset or adjusted BEP on customer's request
- Available in metric and inch sizes

Suffixes	Internal design
A	Standard contact angle
B	Steep contact angle
SP	Special or non-standard bearing
BT1B	Single row tapered roller bearing
C	Cone with boundary dimensions same as basic part number but modified inner geometry
E	Optimized inner geometry
DRW	Special or non-standard bearing
ZB	Optimized roller profile for improved load distribution. It is not necessarily stated in the bearing code

Suffixes	Cage
J	Pressed steel cage

Suffixes	Accuracy, clearance, running
CL0 or CLN	Dimensional and running accuracy to ISO tolerance class 0 or normal
CL2	Dimensional and running accuracy to ISO tolerance class 2
CL3	Dimensional and running accuracy to ISO tolerance class 3
CL4	Dimensional and running accuracy to ISO tolerance class 4

Suffixes	External design
N1 or W	One locating slot in cup
N2 or W	Two locating slots in cup

Suffixes	Set
DB	Two bearings matched for mounting back-to-back
DF	Two bearings matched for mounting face-to-face
DT	Two bearings matched for mounting in tandem
DB...	Two bearings matched for mounting back-to-back. The number immediately following the DB identifies the design of the spacers
DF...	Two bearings matched for mounting face-to-face. The number immediately following the DF identifies the design of the spacers

Suffixes	Alternative designation
TS	Out of standard single row tapered roller bearing followed by drawing number

Part numbering

Several part-numbering systems have been developed in the last 70 years for tapered roller bearings. Inch size bearings are usually given individual part numbers for the cone and the cup, while ISO metric bearings are identified by means of a unique part number for the bearing assembly as a whole.

Inch size

Original system

	Section 1	Section 2	Section 3
	Prefix	Numerical code	Suffix
Example	EE	107060/107105	C

Tab. 2 - Original system: structure

Prefix	Component	Description
-	Cone and cup	-
A	Cone and cup	Part of the standard basic series number
EE	Cone	Large and small ribs close guided rollers. It was originally used to designate close guided rollers. Even if this designation is no longer in use, the prefix has been maintained on existing part numbers
NA	Cone	Non-adjustable. Two single cones with front faces contacting, mated with a double cup to form a double row bearing with internal clearances preset
J	Cone and cup	A J preceding the prefix or numerical code indicates a metric design bearing component

Tab. 3 - Original system: prefixes

ABMA system

	Section 1	Section 2	Section 3	Section 4	Section 5
	Duty class	Angularity	Basic series	Component	Suffix
Example	HM	3	226	49	C

Tab. 4 - ABMA system: structure

Prefix	Component
EL	Extra Light
LL	Lighter than Light
L	Light
LM	Light Medium
M	Medium
HM	Heavy Medium
H	Heavy
HH	Heavier than Heavy
EH	Extra Heavy
T	Thrust only
J	Metric size
-	Different prefixes or absence of prefixes indicates original inch part numbering system

Tab. 5 - ABMA system: duty class

Cup angle	Code	
over	incl.	
0	to 23° 59' 59,99"	1
24°	to 25° 29' 59,99"	2
25° 30'	to 26° 59' 59,99"	3
27°	to 28° 29' 59,99"	4
28° 30'	to 30° 29' 59,99"	5
30° 30'	to 32° 29' 59,99"	6
32° 30'	to 35° 59' 59,99"	7
36°	to 44° 59' 59,99"	8
45°	Up, but not thrust only	9
90°	Thrust only	0

Tab. 6 - ABMA system: angularity

Series indication	Maximum bore range [mm]		Maximum bore range [inches]	
	over	incl.	over	incl.
0-9 incl.	Extremely small tapered roller bearings			
00-19 incl.	0	25,4	0	1
20-99 incl.	25,4	50,8	1	2
000-029 incl.				
039-129 incl.	50,8	76,2	2	3
130-189 incl.	76,2	101,6	3	4
190-239 incl.	101,6	127,0	4	5
240-289 incl.	127,0	152,4	5	6
290-339 incl.	152,4	177,8	6	7
340-389 incl.	177,8	203,2	7	8
390-429 incl.	203,2	228,6	8	9
430-469 incl.	228,6	254,0	9	10
470-509 incl.	254,0	279,4	10	11
510-549 incl.	279,4	304,8	11	12

Tab. 7 (1 of 2) - ABMA system: basic series

Series indication	Maximum bore range [mm]		Maximum bore range [inches]	
	over	incl.	over	incl.
550-579 incl.	304,8	330,2	12	13
580-609 incl.	330,2	355,6	13	14
610-639 incl.	355,6	381,0	14	15
640-659 incl.	381,0	406,4	15	16
660-679 incl.	406,4	431,8	16	17
680-699 incl.	431,8	457,2	17	18
695-709 incl.	457,2	482,6	18	19
710-724 incl.	482,6	508,0	19	20
725-739 incl.	508,0	534,4	20	21
740-754 incl.	534,4	558,8	21	22
755-769 incl.	558,8	584,2	22	23
770-784 incl.	584,2	609,6	23	24
785-799 incl.	609,6	635,0	24	25
800-829 incl.	635,0	762,0	25	30
830-859 incl.	762,0	889,0	30	35
860-879 incl.	889,0	1016,0	35	40
880-889 incl.	1016,0	1270,0	40	50
890-899 incl.	1270,0	1841,5	50	72,5
900-999 incl.	Extremely large tapered roller bearings			

Tab. 7 (2 of 2) - ABMA system: basic series

Component	Component number
Cups	10-19 (maximum section)
Cones	30-49 (minimum section)

Tab. 8 - Component

Metric size

First system

The J prefix placed at the beginning of an ABMA bearing code identifies metric dimensioned and tolerated cones and cups.

	Section 0	Section 1	Section 2	Section 3	Section 4	Section 5
	Prefix	Duty class	Angularity	Basic series	Component	Suffix
Example	J	HM	3	226	49	C

Tab. 9 - Metric system: structure

ISO 15 system

	Section 1	Section 2	Section 3	Section 4	Section 5
	Bearing type	Width series	Diameter series	Bore indication	Suffix
Example	3	2	2	18	C

Tab. 10 - ISO 15 system: structure

ISO 355 system

	Section 1	Section 2	Section 3	Section 4	Section 5	Section 6
	Prefix (none or T)	Contact angle series (alpha)	Diameter series	Width series	Bore diameter	Suffix
Example	T	4	E	B	240	C

Tab. 11 - ISO 15 system: structure

Designation of contact angle series (alpha)	Alpha	
	over	incl.
1	Reserved for future use	
2	10°	13° 52'
3	13° 52'	15° 59'
4	15° 59'	18° 55'
5	18° 55'	23°
6	23°	27°
7	27°	30°

Tab. 12 - ISO 355 system: contact angle series (alpha)

Designation of diameter series	D/d ^{0,77}	
	over	incl.
A	Reserved for future use	
B	3,4	3,8
C	3,8	4,4
D	4,4	4,7
E	4,7	5
F	5	5,6
G	5,6	7

Tab. 13 - ISO 355 system: diameter series

Designation of width series	T/(D-d) ^{0,95}	
	over	incl.
A	Reserved for future use	
B	0,5	0,68
C	0,68	0,8
D	0,8	0,88
E	0,88	1

Tab. 14 - ISO 355 system: width series

Optimized bearing system

The J prefix identifies metric dimensioned and toleranced cones and cups.

	Section 0	Section 1	Section 2	Section 3	Section 4
	Prefix	Duty class	Bore diameter	Component	Suffix
Example	J	P	130	49	A

Tab. 15 - Optimized bearing system: structure

Duty class	Application
C, D, F	General purpose
N	Combination of general purpose and pinion
P	High speed
S, T	Pinion
W	High axial loads

Tab. 16 - Optimized bearing system: duty class

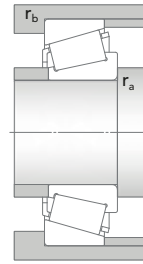
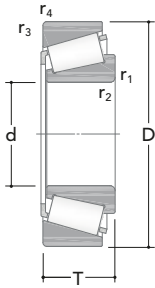

TS

Main dimensions			Basic load ratings		Fatigue load limit C_u	Speed ratings		Designation
d	D	T	Dynamic C	Static C_0		Reference	Limiting	
[mm]			[kN]			[rpm]		
15	42	14,25	27,3	20	2,08	13630	15870	30302
17	40	13,25	23,5	19	1,84	13800	15600	30203
	47	15,25	33,7	25	2,70	11500	13600	30303
	47	20,25	42,7	34	3,63	10700	13930	32303
20	42	15	29,9	27	2,65	11700	13890	32004
	47	15,25	34,5	28	3,00	10700	12800	30204
	52	16,25	42,2	33	3,54	10790	12330	30304
	52	22,25	54,6	45	5,00	9970	11900	32304
22	44	15	31,3	29	2,85	12030	12900	320/22
	47	15	32,9	32	3,28	10600	12030	32005
25	52	16,25	38,3	33	3,50	9770	11240	30205
	52	19,25	50,8	46	4,90	10010	11200	32205
	52	22	57,3	56	6,00	9310	11450	33205
	62	18,25	56	43	4,75	8700	10580	30305
	62	18,25	46,2	40	4,50	7740	9670	31305
	62	25,25	73,1	62	7,20	8260	10200	32305
	62	25,25	73,1	62	7,20	8260	10200	32305
28	52	16	38,4	38	4,00	9100	11260	320/28
	58	17,25	47,2	41	4,40	9240	10300	302/28
	58	20,25	51,7	50	5,50	8540	10300	322/28
30	55	17	44	44	4,59	8800	10550	32006
	62	17,25	50,7	44	4,80	8200	9500	30206
	62	21,25	62,2	57	6,30	8200	9400	32206
	62	25	79	77	8,40	7880	9490	33206
	72	20,75	69	56	6,40	7200	8810	30306
	72	20,75	58,9	50	5,70	6850	8300	31306
	72	28,75	93,9	84	9,76	6700	8600	32306
	72	28,75	93,9	84	9,76	6700	8600	32306

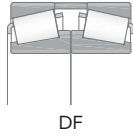
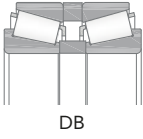

Dimensions					Factor	Mass	Designation
d	r _{1,2min}	r _{3,4min}	r _{amax}	r _{bmax}	e		
[mm]						[kg]	
15	1	1	1	1	0,28	0,094	30302
17	1	1	1	1	0,35	0,079	30203
	1	1	1	1	0,28	0,13	30303
	1	1	1	1	0,28	0,17	32303
20	0,6	0,6	0,6	0,6	0,37	0,098	32004
	1	1	1	1	0,35	0,12	30204
	1,5	1,5	1,5	1,5	0,3	0,17	30304
	1,5	1,5	1,5	1,5	0,3	0,23	32304
22	0,6	0,6	0,6	0,6	0,4	0,1	320/22
25	0,6	0,6	0,6	0,6	0,43	0,11	32005
	1	1	1	1	0,37	0,15	30205
	1	1	1	1	0,57	0,19	32205
	1	1	1	1	0,35	0,22	33205
	1,5	1,5	1,5	1,5	0,3	0,26	30305
	1,5	1,5	1,5	1,5	0,83	0,27	31305
	1,5	1,5	1,5	1,5	0,3	0,36	32305
28	1	1	1	1	0,43	0,14	320/28
	1	1	1	1	0,37	0,2	302/28
	1	1	1	1	0,57	0,25	322/28
30	1	1	1	1	0,43	0,17	32006
	1	1	1	1	0,37	0,23	30206
	1	1	1	1	0,37	0,29	32206
	1	1	1	1	0,35	0,35	33206
	1,5	1,5	1,5	1,5	0,31	0,38	30306
	1,5	1,5	1,5	1,5	0,83	0,39	31306
	1,5	1,5	1,5	1,5	0,31	0,55	32306

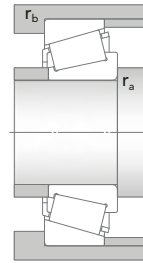
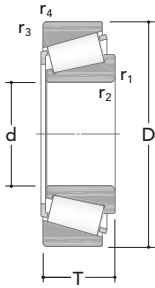

TS

Main dimensions			Basic load ratings		Fatigue load limit C_u	Speed ratings		Designation
d	D	T	Dynamic C	Static C_0		Reference	Limiting	
[mm]			[kN]			[rpm]		
32	53	14,5	33,2	36	3,60	8800	10700	26749/710
	58	17	45	47	4,70	8200	9600	320/32
35	62	18	52,8	54	5,87	7600	9100	32007
	72	18,25	63,6	57	6,00	7360	8210	30207
	72	24,25	82,4	77	8,60	7250	8400	32207
	72	28	104,1	106	11,80	6280	8100	33207
	80	22,75	87,8	74	8,30	6830	7750	30307
	80	22,75	75,4	67	7,80	5700	7270	31307
	80	32,75	117,1	114	11,30	6160	7790	32307
	80	32,75	117,1	114	11,30	6160	7790	32307
37	80	32,75	94,4	114	12,90	6000	8200	32307/37
38	63	17	45,4	53	5,30	7690	9200	69349/310
	68	19	53,4	71	7,67	6800	8800	32008/38
40	68	19	65,2	72	7,55	6700	8260	32008
	75	26	98,8	103	11,50	6500	7910	33108
	80	19,75	75,9	67	7,76	6390	7400	30208
	80	24,75	90,4	86	9,90	6310	7300	32208
	80	32	128	133	15,00	5750	7300	33208
	85	33	150	150	17,30	6010	7400	T2EE 040
	90	25,25	105,8	96	10,70	5800	6970	30308
	90	25,25	89,9	81	9,50	5300	6400	31308
	90	35,25	141	138	16,00	5430	6900	32308
45	75	20	71,1	80	8,80	6430	7320	32009
	80	26	102,7	115	12,80	6400	6800	33109
	85	20,75	82,5	76	8,71	5700	6970	30209
	85	24,75	98,3	99	11,00	6100	6900	32209
	85	32	130	143	16,30	5570	6470	33209
	95	29	108,8	111	12,80	4940	6120	T7FC 045
	95	36	180	188	20,60	5450	6900	T2ED 045
	95	36	180	188	20,60	5450	6900	T2ED 045

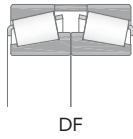
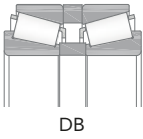

Dimensions					Factor	Mass	Designation
d	r _{1,2min}	r _{3,4min}	r _{amax}	r _{bmax}	e		
[mm]						[kg]	
32	3,6	1,3	3	1,3	0,33	0,11	26749/710
	1	1	1	1	0,46	0,19	320/32
35	1	1	1	1	0,44	0,23	32007
	1,5	1,5	1,5	1,5	0,37	0,33	30207
	1,5	1,5	1,5	1,5	0,37	0,44	32207
	1,5	1,5	1,5	1,5	0,35	0,53	33207
	2	1,5	2	1,5	0,31	0,51	30307
	2	1,5	2	1,5	0,83	0,52	31307
	2	1,5	2	1,5	0,31	0,8	32307
37	2	1,5	2	1,5	0,54	0,77	32307/37
38	1,3	1,3	1,3	1,3	0,43	0,21	69349/310
	1	1	1	1	0,37	0,3	32008/38
40	1	1	1	1	0,37	0,28	32008
	1,5	1,5	1,5	1,5	0,35	0,5	33108
	1,5	1,5	1,5	1,5	0,37	0,42	30208
	1,5	1,5	1,5	1,5	0,37	0,53	32208
	1,5	1,5	1,5	1,5	0,35	0,73	33208
	1	2	1	2	0,35	0,9	T2EE 040
	2	1,5	2	1,5	0,35	0,73	30308
	2	1,5	2	1,5	0,83	0,72	31308
45	2	1,5	2	1,5	0,35	1,05	32308
	1	1	1	1	0,4	0,34	32009
	1,5	1,5	1,5	1,5	0,37	0,55	33109
	1,5	1,5	1,5	1,5	0,4	0,47	30209
	1,5	1,5	1,5	1,5	0,4	0,58	32209
	1,5	1,5	1,5	1,5	0,4	0,79	33209
	2,5	2,5	2,5	2,5	0,88	0,93	T7FC 045
	2,5	2,5	2,5	2,5	0,33	1,2	T2ED 045

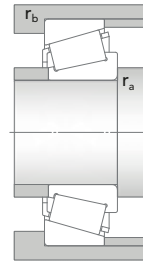
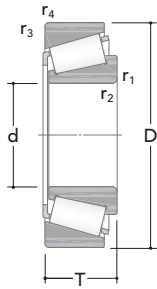

TS

Main dimensions			Basic load ratings		Fatigue load limit C_u	Speed ratings		Designation
d	D	T	Dynamic C	Static C_0		Reference	Limiting	
[mm]			[kN]			[rpm]		
45	100	27,25	132	121	14,20	5100	6000	30309
(cont.)	100	27,25	113	103	12,40	4800	5860	31309
	100	38,25	172	172	20,20	4780	6000	32309
46	75	18	50	71	7,65	6100	8200	503349/310
50	80	20	75	89	9,54	5800	7070	32010
	80	24	85,4	101	11,50	5800	6800	33010
	82	21,5	89,9	100	11,00	5800	7000	104948/910
	85	26	106,4	122	13,40	5300	6400	33110
	90	21,75	93	91	10,50	5400	6400	30210
	90	24,75	100,3	99	11,60	5400	6600	32210
	90	28	132	139	16,00	5320	6800	205149/110
	90	32	141	162	18,10	4800	6120	33210
	100	36	189	200	22,40	5160	6200	T2ED 050
	105	32	134	138	16,00	4330	5400	T7FC 050
	110	29,25	154	140	16,60	5100	5400	30310
	110	29,25	131	119	14,40	4300	5100	31310
	110	42,25	209	215	24,00	4300	5560	32310
55	90	23	98,6	117	12,80	5000	6120	32011
	90	27	112	136	15,40	5400	6040	33011
	95	30	135	156	17,60	5230	5800	33111
	100	22,75	110	105	12,00	5000	5790	30211
	100	26,75	132	130	15,00	4800	5830	32211
	100	35	168	193	21,30	4300	5540	33211
	110	39	221	229	26,00	4400	5700	T2ED 055
	115	34	157	163	19,30	3800	4820	T7FC 055
	120	31,5	174	163	19,30	4600	4890	30311
	120	31,5	148	137	16,60	4010	4900	31311
	120	45,5	242	260	27,40	4200	4800	32311
60	95	23	100,9	123	13,30	5100	5880	32012

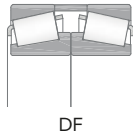
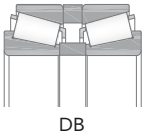

Dimensions					Factor	Mass	Designation
d	r _{1,2min}	r _{3,4min}	r _{amax}	r _{bmax}	e		
[mm]						[kg]	
45	2	1,5	2	1,5	0,35	0,97	30309
(cont.)	2	1,5	2	1,5	0,83	0,95	31309
	2	1,5	2	1,5	0,35	1,4	32309
	46	2,3	1,6	2,3	1,5	0,4	0,3
50	1	1	1	1	0,43	0,38	32010
	1	1	1	1	0,31	0,45	33010
	3,6	1,2	3,4	1,2	0,3	0,43	104948/910
	1,5	1,5	1,5	1,5	0,4	0,58	33110
	1,5	1,5	1,5	1,5	0,43	0,54	30210
	1,5	1,5	1,5	1,5	0,43	0,62	32210
	3	2,5	2,5	2,5	0,33	0,75	205149/110
	1,5	1,5	1,5	1,5	0,4	0,86	33210
	2,5	2,5	2,5	2,5	0,35	1,3	T2ED 050
	3	3	2,5	2,5	0,88	1,25	T7FC 050
	2,5	2	2,5	2	0,35	1,25	30310
	2,5	2	2,5	2	0,83	1,2	31310
	2,5	2	2,5	2	0,35	1,95	32310
55	1,5	1,5	1,5	1,5	0,4	0,56	32011
	1,5	1,5	1,5	1,5	0,31	0,66	33011
	1,5	1,5	1,5	1,5	0,37	0,85	33111
	2	1,5	2	1,5	0,4	0,7	30211
	2	1,5	2	1,5	0,4	0,84	32211
	2	1,5	2	1,5	0,4	1,15	33211
	2,5	2,5	2,5	2,5	0,35	1,7	T2ED 055
	3	3	2,5	2,5	0,88	1,6	T7FC 055
	2,5	2	2,5	2	0,35	1,55	30311
	2,5	2	2,5	2	0,83	1,55	31311
	2,5	2	2,5	2	0,35	2,5	32311
60	1,5	1,5	1,5	1,5	0,43	0,59	32012

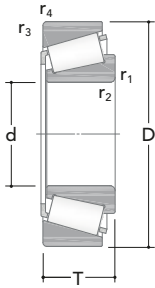

TS

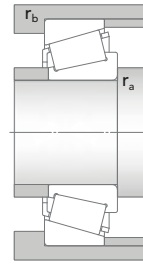

Main dimensions			Basic load ratings		Fatigue load limit C_u	Speed ratings		Designation
d	D	T	Dynamic C	Static C_0		Reference	Limiting	
[mm]			[kN]		[rpm]			
60	95	27	112	143	16,00	5100	5800	33012
(cont.)	100	30	145	168	19,80	4730	5570	33112
	110	23,75	119	113	13,30	4800	5290	30212
	110	29,75	156	161	18,50	4540	5100	32212
	110	38	209	239	26,20	4060	5150	33212
	115	40	240	259	30,00	4450	5300	T2EE 060
	125	37	189	202	24,70	3690	4630	T7FC 060
	130	33,5	208	197	23,50	3800	4630	30312
	130	33,5	177	167	20,30	3500	4650	31312
	130	48,5	279	301	33,00	3550	4570	32312
65	100	23	103,4	127	14,00	4800	5230	32013
	100	27	120	151	17,50	4800	5400	33013
	110	28	150	183	21,20	4360	5300	511946/910
	110	31	172	194	22,30	4280	5300	T2DD 065
	110	34	177	205	24,00	4380	4800	33113
	120	24,75	142	132	16,50	4300	4870	30213
	120	32,75	187	191	23,00	4010	4840	32213
	120	41	238	274	30,10	3600	4600	33213
	130	37	195	214	25,70	3390	4340	T7FC 065
	140	36	243	228	27,50	3560	4100	30313
	140	36	204	194	23,50	3200	4120	31313
	140	51	322	337	40,00	3190	4100	32313
70	110	25	124,9	151	17,50	4100	4800	32014
	110	31	159	199	22,50	4380	4800	33014
	120	37	213	253	28,20	3800	4670	33114
	125	26,25	157	154	18,00	3800	4570	30214
	125	33,25	194	206	24,70	3950	4540	32214
	125	41	250	281	33,00	3500	4340	33214
	130	43	287	322	38,00	3700	4700	T2ED 070
	140	39	219	238	27,70	3100	3920	T7FC 070
	150	38	229	217	27,00	3130	3980	31314

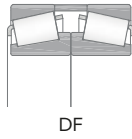
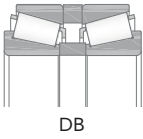

Dimensions					Factor	Mass	Designation
d	r _{1,2min}	r _{3,4min}	r _{amax}	r _{bmax}	e		
[mm]						[kg]	
60	1,5	1,5	1,5	1,5	0,33	0,7	33012
(cont.)	1,5	1,5	1,5	1,5	0,4	0,92	33112
	2	1,5	2	1,5	0,4	0,88	30212
	2	1,5	2	1,5	0,4	1,15	32212
	2	1,5	2	1,5	0,4	1,55	33212
	2,5	2,5	2,5	2,5	0,33	1,85	T2EE 060
	3	3	2,5	2,5	0,83	2,05	T7FC 060
	3	2,5	3	2,5	0,35	1,95	30312
	3	2,5	3	2,5	0,83	1,9	31312
	3	2,5	3	2,5	0,35	3,1	32312
65	1,5	1,5	1,5	1,5	0,46	0,63	32013
	1,5	1,5	1,5	1,5	0,35	0,75	33013
	3	2,5	2,8	2,5	0,4	1,05	511946/910
	2	2	2	2	0,33	1,15	T2DD 065
	1,5	1,5	1,5	1,5	0,4	1,3	33113
	2	1,5	2	1,5	0,4	1,1	30213
	2	1,5	2	1,5	0,4	1,5	32213
	2	1,5	2	1,5	0,4	2	33213
	3	3	2,5	2,5	0,88	2,2	T7FC 065
	3	2,5	3	2,5	0,35	2,45	30313
	3	2,5	3	2,5	0,83	2,35	31313
	3	2,5	3	2,5	0,35	3,75	32313
70	1,5	1,5	1,5	1,5	0,43	0,85	32014
	1,5	1,5	1,5	1,5	0,28	1,05	33014
	2	1,5	2	1,5	0,37	1,7	33114
	2	1,5	2	1,5	0,43	1,25	30214
	2	1,5	2	1,5	0,43	1,6	32214
	2	1,5	2	1,5	0,4	2,1	33214
	8	2,5	7	2,5	0,33	2,45	T2ED 070
	3	3	2,5	2,5	0,88	2,65	T7FC 070
	3	2,5	3	2,5	0,83	2,9	31314

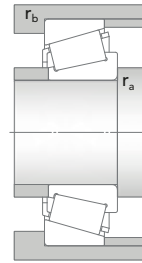
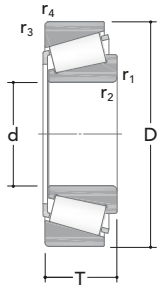

TS

Main dimensions			Basic load ratings		Fatigue load limit C_u	Speed ratings		Designation
d	D	T	Dynamic C	Static C_0		Reference	Limiting	
[mm]			[kN]			[rpm]		
70	150	38	271	256	31,00	3530	3910	30314
(cont.)	150	54	361	396	43,00	3050	3930	32314
75	105	20	87,5	117	13,10	4380	5200	32915
	115	25	130	164	18,50	3800	4680	32015
	115	31	168	228	26,00	3900	4660	33015
	120	31	172	214	25,00	3950	4800	714249/210
	125	37	216	266	30,00	3600	4320	33115
	130	27,25	171	177	20,30	3600	4390	30215
	130	33,25	195	211	24,60	3590	4330	32215
	130	41	252	296	34,00	3200	4110	33215
	145	52	369	447	50,00	3300	4100	T3FE 075
	150	42	250	278	31,00	2900	3730	T7FC 075
	160	40	301	292	34,00	3000	3800	30315
	160	40	253	246	29,00	2840	3730	31315
	160	58	413	472	48,00	2870	3690	32315
80	125	29	166	218	24,30	3640	4290	32016
	125	36	208	285	32,00	3640	4300	33016
	130	35	213	278	31,00	3640	4400	515649/610
	130	37	222	281	31,00	3670	4250	33116
	140	28,25	183	182	21,30	3430	4120	30216
	140	35,25	231	242	28,90	3520	3870	32216
	140	46	306	371	41,90	3000	3900	33216
	160	45	277	311	36,00	2700	3540	T7FC 080
	170	42,5	274	267	30,30	2700	3430	31316
	170	42,5	337	324	36,00	2840	3500	30316
	170	61,5	468	499	56,00	2900	3500	32316
85	130	29	172	221	25,80	3380	4130	32017
	130	36	223	306	35,00	3500	4210	33017
	140	41	269	344	38,00	3300	3890	33117
	150	30,5	215	220	25,50	3290	3710	30217

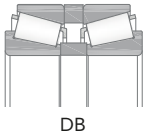

DB

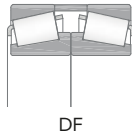

DF

Dimensions					Factor	Mass	Designation
d	r _{1,2min}	r _{3,4min}	r _{amax}	r _{bmax}	e		
[mm]						[kg]	
70	3	2,5	3	2,5	0,35	2,95	30314
(cont.)	3	2,5	3	2,5	0,35	4,55	32314
75	1	1	1	1	0,33	0,48	32915
	1,5	1,5	1,5	1,5	0,46	0,91	32015
	1,5	1,5	1,5	1,5	0,3	1,15	33015
	2,5	2,5	2,5	2	0,44	1,3	714249/210
	2	1,5	2	1,5	0,4	1,8	33115
	2	1,5	2	1,5	0,43	1,4	30215
	2	1,5	2	1,5	0,43	1,65	32215
	2	1,5	2	1,5	0,43	2,2	33215
	11	3	11	3	0,43	3,9	T3FE 075
	3	3	2,5	2,5	0,88	3,25	T7FC 075
	3	2,5	3	2,5	0,35	3,5	30315
	3	2,5	3	2,5	0,83	3,5	31315
	3	2,5	3	2,5	0,35	5,55	32315
80	1,5	1,5	1,5	1,5	0,43	1,3	32016
	1,5	1,5	1,5	1,5	0,28	1,65	33016
	3	2,5	2,8	2,5	0,4	1,75	515649/610
	2	1,5	2	1,5	0,43	1,85	33116
	2,5	2	2,5	2	0,43	1,6	30216
	2,5	2	2,5	2	0,43	2,05	32216
	2,5	2	2,5	2	0,43	2,9	33216
	3	3	2,5	2,5	0,88	4	T7FC 080
	3	2,5	3	2,5	0,83	4,05	31316
	3	2,5	3	2,5	0,35	4,15	30316
	3	2,5	3	2,5	0,35	6,2	32316
85	1,5	1,5	1,5	1,5	0,44	1,35	32017
	1,5	1,5	1,5	1,5	0,3	1,75	33017
	2,5	2	2,5	2	0,4	2,45	33117
	2,5	2	2,5	2	0,43	2,05	30217

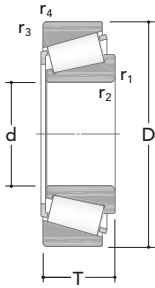

TS

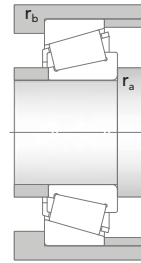

Main dimensions			Basic load ratings		Fatigue load limit C_u	Speed ratings		Designation
d	D	T	Dynamic C	Static C_0		Reference	Limiting	
[mm]			[kN]			[rpm]		
85	150	38,5	263	287	33,30	3320	3700	32217
(cont.)	150	49	356	427	48,00	2900	3800	33217
	180	44,5	367	368	40,20	2700	3300	30317
	180	44,5	294	287	32,00	2500	3270	31317
	180	63,5	499	552	58,00	2700	3300	32317
90	140	32	208	267	31,00	3360	3710	32018
	140	39	265	350	40,00	3220	3960	33018
	150	45	307	393	43,00	3050	3770	33118
	160	32,5	237	246	28,40	3150	3400	30218
	160	42,5	309	344	38,00	3040	3540	32218
	190	46,5	353	398	44,00	2500	3400	30318
	190	46,5	281	314	35,60	2300	2970	31318
	190	67,5	491	618	64,70	2500	3300	32318
95	145	32	205	268	30,70	3100	3700	32019
	145	39	275	374	40,60	3000	3700	33019
	170	34,5	266	276	31,40	2870	3300	30219
	170	45,5	348	392	43,00	2970	3280	32219
	180	49	274	398	44,00	2300	2990	T7FC 095
	200	49,5	351	395	42,00	2500	2940	30319
	200	49,5	311	357	39,00	2300	2900	31319
	200	71,5	535	675	71,00	2300	2900	32319
100	140	25	147	202	22,60	3000	3900	32920
	145	24	154	191	20,70	3000	3700	T4CB 100
	150	32	210	281	31,00	2900	3490	32020
	150	39	278	387	41,80	3120	3400	33020
	155	32	173	284	31,00	2680	-	332118
	157	42	248	404	42,10	2900	3700	220149/110
	157	42	246	404	43,00	2800	-	328115
	160	41	249	388	41,70	2700	3700	720249/210
	165	47	386	475	53,00	2910	3600	T2EE 100

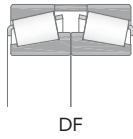
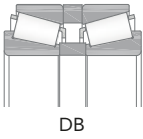

Dimensions					Factor	Mass	Designation
d	r _{1,2min}	r _{3,4min}	r _{amax}	r _{bmax}	e		
[mm]						[kg]	
85	2,5	2	2,5	2	0,43	2,6	32217
(cont.)	2,5	2	2,5	2	0,43	3,55	33217
	4	3	4	3	0,35	4,85	30317
	4	3	4	3	0,83	4,6	31317
	4	3	4	3	0,35	7,6	32317
90	2	1,5	2	1,5	0,43	1,75	32018
	2	1,5	2	1,5	0,27	2,2	33018
	2,5	2	2,5	2	0,4	3,1	33118
	2,5	2	2,5	2	0,43	2,5	30218
	2,5	2	2,5	2	0,43	3,35	32218
	4	3	4	3	0,35	5,65	30318
	4	3	4	3	0,83	5,4	31318
	4	3	4	3	0,35	8,4	32318
95	2	1,5	2	1,5	0,44	1,85	32019
	2	1,5	2	1,5	0,28	2,3	33019
	3	2,5	3	2,5	0,43	3	30219
	3	2,5	3	2,5	0,43	4,1	32219
	4	4	3	3	0,88	5,25	T7FC 095
	4	3	4	3	0,35	6,45	30319
	4	3	4	3	0,83	6,3	31319
	4	3	4	3	0,35	9,8	32319
100	1,5	1,5	1,5	1,5	0,33	1,15	32920
	3	3	2,5	2,5	0,48	1,2	T4CB 100
	2	1,5	2	1,5	0,46	1,9	32020
	2	1,5	2	1,5	0,28	2,4	33020
	2,5	2,5	2,5	2,5	0,46	2,2	332118
	8	3,5	7	3,3	0,33	2,9	220149/110
	3	3,5	3	3	0,33	2,95	328115
	3	2,5	2,8	2,5	0,48	3,05	720249/210
	3	3	2,5	2,5	0,31	3,9	T2EE 100

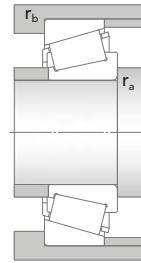
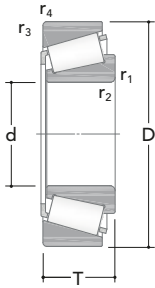

TS

Main dimensions			Basic load ratings		Fatigue load limit C_u	Speed ratings		Designation
d	D	T	Dynamic C	Static C_0		Reference	Limiting	
[mm]			[kN]			[rpm]		
100	180	37	300	320	36,00	2740	3080	30220
(cont.)	180	49	391	446	47,00	2740	3100	32220
	180	63	526	655	71,00	2300	3100	33220
	215	45	258	319	35,10	1860	-	328180
	215	51,5	435	483	54,00	2300	2750	30320
	215	56,5	401	471	50,00	2100	2590	31320
	215	77,5	610	790	82,00	2100	2820	32320
105	160	35	249	338	37,20	2950	3280	32021
	160	43	304	435	45,00	2940	3270	33021
	190	39	334	354	40,00	2500	2940	30221
	190	53	448	514	55,00	2500	3010	32221
	225	53,5	460	528	57,00	1990	2600	30321
	225	81,5	650	807	86,00	1900	2600	32321
106	160	35	204	337	37,30	2610	-	331974
110	150	25	154	222	24,00	2900	3700	32922
	160	27	154	235	27,10	2540	-	T4CB 110
	170	38	289	390	40,00	2800	3100	32022
	170	47	348	497	53,00	2700	3170	33022
	180	47	323	513	57,00	2400	-	522649/10
	180	56	451	634	65,10	2500	2960	33122
	200	41	380	411	42,00	2300	2750	30222
	200	56	493	578	60,00	2300	2800	32222
	240	48	297	360	41,10	1700	-	328164
	240	54,5	510	578	63,00	2100	2470	30322
	240	63	493	580	62,00	1800	2470	31322
	240	84,5	667	839	85,60	1800	2400	32322
120	165	29	204	309	32,00	2780	3200	32924
	170	27	196	246	26,90	2500	3200	T4CB 120
	170	27	136	225	25,00	2200	-	328031

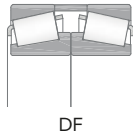
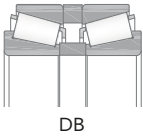

DB

DF

Dimensions					Factor	Mass	Designation
d	r _{1,2min}	r _{3,4min}	r _{amax}	r _{bmax}	e		
[mm]						[kg]	
100	3	2,5	3	2,5	0,43	3,6	30220
(cont.)	3	2,5	3	2,5	0,43	4,95	32220
	3	2,5	3	2,5	0,4	6,7	33220
	3	3	2,5	2,5	1,05	6,5	328180
	4	3	4	3	0,35	7,95	30320
	4	3	4	3	0,83	8,6	31320
	4	3	4	3	0,35	12,5	32320
105	2,5	2	2,5	2	0,44	2,45	32021
	2,5	2	2,5	2	0,28	3	33021
	3	2,5	3	2,5	0,43	4,3	30221
	3	2,5	3	2,5	0,43	6,05	32221
	4	3	4	3	0,35	9,15	30321
	4	3	4	3	0,35	14	32321
106	6,4	2	6	2	0,44	2,3	331974
110	1,5	1,5	1,5	1,5	0,35	1,25	32922
	3	3	2,5	2,5	0,44	1,6	T4CB 110
	2,5	2	2,5	2	0,43	3,05	32022
	2,5	2	2,5	2	0,28	3,85	33022
	3	2,5	2,5	2	0,40	4,65	522649/10
	2,5	2	2,5	2	0,43	5,5	33122
	3	2,5	3	2,5	0,43	5,05	30222
	3	2,5	3	2,5	0,43	7,1	32222
	3	3	2,5	2,5	1,05	8,45	328164
	4	3	4	3	0,35	11	30322
	4	3	4	3	0,83	12	31322
	4	3	4	3	0,35	16,5	32322
120	1,5	1,5	1,5	1,5	0,35	1,8	32924
	3	3	2,5	2,5	0,48	1,75	T4CB 120
	5	2,5	4	2,5	0,79	1,8	328031

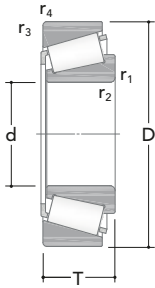

TS

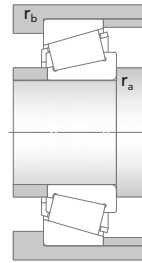

Main dimensions			Basic load ratings		Fatigue load limit	Speed ratings		Designation
d	D	T	Dynamic C	Static C ₀	C _u	Reference	Limiting	
[mm]			[kN]			[rpm]		
120 (cont.)	180	38	302	416	42,40	2530	2900	32024
	180	48	356	541	56,00	2500	2990	33024
	215	43,5	412	462	49,00	2160	2640	30224
	215	61,5	578	690	73,00	2180	2590	32224
	260	59,5	595	709	73,60	1900	2300	30324
	260	68	574	686	73,00	1600	2110	31324
	260	90,5	851	1119	110,00	1700	2230	32324
130	180	32	242	370	37,00	2300	2900	32926
	185	29	195	314	32,60	2230	-	T4CB 130
	200	45	388	540	55,00	2140	2580	32026
	220	64	492	758	75,70	1950	-	442768
	230	43,75	444	493	51,00	2010	2390	30226
	230	64	514	739	75,00	1860	-	443742
	230	67,75	586	836	84,00	1900	2400	32226
	280	63,75	678	804	81,10	1700	2120	30326
	280	72	645	782	80,00	1500	2050	31326
	280	98,75	1022	1353	131,00	1430	2060	32326
140	190	32	253	386	40,00	2300	2800	32928
	195	29	245	327	33,30	2200	2700	T4CB 140
	210	45	403	593	57,70	2240	2430	32028
	250	45,75	444	578	57,70	1800	2250	30228
	250	71,75	685	988	101,00	1800	2230	32228
	300	63,5	652	1011	94,00	1450	-	440740
	300	67,75	797	947	93,00	1580	1940	30328
	300	77	745	900	90,00	1400	1880	31328
150	210	32	284	387	40,00	2030	2500	T4DB 150
	225	48	458	657	65,30	2050	2250	32030
	225	59	557	862	85,00	2010	2250	33030
	270	49	453	560	57,00	1700	2110	30230
	270	77	777	1124	114,00	1600	2120	32230

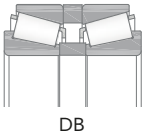

DB

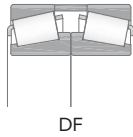

DF

Dimensions					Factor	Mass	Designation
d	r _{1,2min}	r _{3,4min}	r _{amax}	r _{bmax}	e		
[mm]						[kg]	
120	2,5	2	2,5	2	0,46	3,3	32024
(cont.)	2,5	2	2,5	2	0,3	4,15	33024
	3	2,5	3	2,5	0,43	6,1	30224
	3	2,5	3	2,5	0,43	9,05	32224
	4	3	4	3	0,35	13,5	30324
	4	3	4	3	0,83	15,5	31324
	4	3	4	3	0,35	21,5	32324
130	2	1,5	2	1,5	0,33	2,4	32926
	3	3	2	2,5	0,48	2,25	T4CB 130
	2,5	2	2,5	2	0,43	4,95	32026
	3	3	2,5	2,5	0,33	9,4	442768
	4	3	4	3	0,43	6,85	30226
	3	2,5	2,5	2,5	0,43	10,5	443742
	4	3	4	3	0,43	11	32226
	5	4	5	4	0,35	17	30326
	5	4	5	4	0,83	18,5	31326
	5	4	3	3	0,35	30,5	32326
140	2	1,5	2	1,5	0,35	2,55	32928
	3	3	2,5	2,5	0,5	2,4	T4CB 140
	2,5	2	2,5	2	0,46	5,25	32028
	4	3	4	3	0,43	8,7	30228
	4	3	4	3	0,43	14	32228
	7	3,3	6	3	0,31	21,5	440740
	5	4	3	3	0,35	21	30328
	5	4	5	4	0,83	22,5	31328
150	3	3	2,5	2,5	0,46	3,1	T4DB 150
	3	2,5	3	2,5	0,46	6,4	32030
	3	2,5	3	2,5	0,37	8,05	33030
	4	3	4	3	0,43	10,5	30230
	4	3	4	3	0,43	18	32230

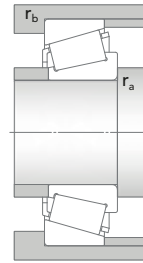
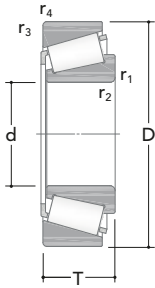

TS

Main dimensions			Basic load ratings		Fatigue load limit C_u	Speed ratings		Designation
d	D	T	Dynamic C	Static C_0		Reference	Limiting	
[mm]			[kN]			[rpm]		
150 (cont.)	320	72	872	1056	104,00	1450	1750	30330
	320	82	835	1012	101,00	1300	1750	31330
	320	114	1167	1640	155,00	1290	-	32330
160	220	32	296	411	41,90	1960	2400	T4DB 160
	240	51	534	772	77,30	1810	2120	32032
	245	61	640	981	96,40	1860	2100	T4EE 160
	290	52	573	729	73,00	1500	1890	30232
	290	84	928	1412	131,00	1500	1900	32232
	340	75	979	1197	112,00	1400	1750	30332
165	290	63500	651	1004	95,00	1450	-	440771
170	230	32	311	439	43,00	1800	2300	T4DB 170
	230	38	347	591	54,00	1800	2300	32934
	240	46	395	757	72,80	1630	-	734449/410
	260	57	629	918	88,00	1750	1920	32034
	310	57	649	865	83,00	1400	1730	30234
	310	91	1073	1619	151,00	1400	1740	32234
	360	80	1087	1324	131,00	1250	1540	30334
180	240	32	306	455	44,00	1820	2200	T4DB 180
	250	45	439	732	68,00	1750	2200	32936
	250	47	370	690	67,00	1560	-	736149/110
	280	64	785	1161	110,00	1500	1900	32036
	320	57	636	818	80,00	1400	1700	30236
	320	91	1080	1641	149,00	1300	1630	32236
190	260	45	447	773	71,00	1610	1900	32938
	260	46	443	768	72,00	1640	2000	738249/210
	260	46	356	773	71,00	1460	-	332265
	280	50	479	826	79,00	1000	1400	328166
	290	64	798	1212	111,00	1490	1700	32038

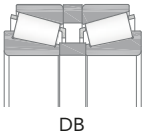

DB

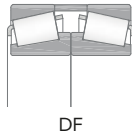

DF

Dimensions					Factor	Mass	Designation
d	r _{1,2min}	r _{3,4min}	r _{amax}	r _{bmax}	e		
[mm]						[kg]	
150	5	4	3	3	0,35	28,5	30330
(cont.)	5	4	5	4	0,83	27	31330
	5	4	3	3	0,35	46	32330
160	3	3	2,5	2,5	0,48	3,25	T4DB 160
	3	2,5	3	2,5	0,46	7,85	32032
	3	2	3	2	0,44	10,5	T4EE 160
	4	3	4	3	0,43	13	30232
	4	3	4	3	0,43	23	32232
	5	4	5	4	0,35	29	30332
165	7	3,3	6,5	3	0,31	17,5	440771
170	3	3	2,5	2,5	0,46	3,45	T4DB 170
	2,5	2	2,5	2	0,37	4,5	32934
	3	2,5	2,5	2,5	0,44	6,5	734449/410
	3	2,5	3	2,5	0,44	10,5	32034
	5	4	5	4	0,43	16,5	30234
	5	4	5	4	0,43	28,5	32234
	5	4	3	3	0,35	35	30334
180	3	3	2,5	2,5	0,48	3,6	T4DB 180
	2,5	2	2,5	2	0,48	6,65	32936
	3	2,5	2,5	2,5	0,48	6,65	736149/110
	3	2,5	3	2,5	0,43	14	32036
	5	4	5	4	0,46	17	30236
	5	4	5	4	0,46	29,5	32236
190	2,5	2	2,5	2	0,48	7	32938
	3	4	2,8	2,5	0,48	7	738249/210
	3	2,5	2,5	2	0,48	7,2	332265
	3	4	2,5	3	0,30	10,7	328166
	3	2,5	3	2,5	0,44	15	32038

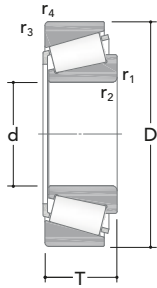

TS

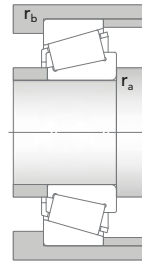

Main dimensions			Basic load ratings		Fatigue load limit C_u	Speed ratings		Designation
d	D	T	Dynamic C	Static C_0		Reference	Limiting	
[mm]			[kN]			[rpm]		
190	340	60	757	1013	94,00	1300	1540	30238
(cont.)	340	97	1261	1934	176,00	1200	1550	32238
200	260	28	198	416	39,00	1470	-	329053
	270	37	404	599	57,00	1500	1900	T4DB 200
	270	45	376	758	72,00	1450	-	331473
	280	51	587	954	88,00	1570	1800	32940
	300	54,5	558	1005	95,00	1360	-	330710
	300	65	660	1265	115,00	1300	-	840449/410
	310	70	807	1383	126,00	1300	1670	32040
	317,5	70	731	1333	119,00	1260	-	440408
	360	64	833	1126	105,00	1200	1490	30240
	360	104	1288	2004	180,00	1200	1480	32240
210	260	30	197	459	43,10	1470	-	332465
	300	54,5	552	987	96,00	1340	-	332284
215	340	76	900	1644	151,00	870	1150	332110
220	285	41	490	837	74,00	1470	1760	T2DC 220
	300	51	599	991	92,30	1360	1700	32944
	340	76	944	1638	152,00	1200	1500	32044
	340	90,475	1053	2067	184,00	1150	-	328144
	400	72	1054	1395	127,00	1100	1390	30244
	400	90	1078	1734	158,00	890	-	332348
	400	114	1717	2724	230,00	1000	1290	32244
240	320	42	523	813	73,70	1280	1500	T4EB 240
	320	51	624	1070	97,40	1270	1500	32948
	320	57	762	1308	119,00	1290	1500	T2EE 240
	360	76	1000	1815	155,00	1100	1370	32048
	440	127	1897	3351	270,00	960	1140	32248

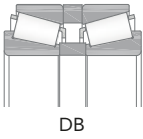

DB

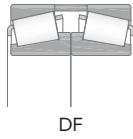

DF

Dimensions					Factor	Mass	Designation
d	r _{1,2min}	r _{3,4min}	r _{amax}	r _{bmax}	e		
[mm]						[kg]	
190	5	4	5	4	0,43	20,5	30238
(cont.)	5	4	5	4	0,43	36	32238
200	1	1,5	1	1,5	0,30	4	329053
	3	3	2,5	2,5	0,48	5,5	T4DB 200
	2,5	2	2	2	0,48	7	331473
	3	2,5	3	2,5	0,4	9,5	32940
	4	3	3	2,5	0,31	12,7	330710
	3,5	2,5	3	2	0,52	15,5	840449/410
	3	2,5	2,5	2,5	0,43	19	32040
	3,5	3,5	3	3	0,43	20,3	440408
	5	4	5	4	0,43	24,5	30240
	5	4	5	4	0,4	42,5	32240
210	2	1,5	2	1,5	0,52	3,4	332465
	4	3	4	2,5	0,31	11,4	332284
215	4	3	3	2,5	0,43	25,5	332110
220	4	3	3	2,5	0,31	6,45	T2DC 220
	3	2,5	3	2,5	0,43	10	32944
	4	3	4	3	0,43	24,5	32044
	4	3	3	2,5	0,35	30,3	328144
	5	4	4	3	0,43	34,5	30244
	5	5	4	4	0,75	45,5	332348
	5	4	4	3	0,43	59,5	32244
240	3	3	2,5	2,5	0,46	8,45	T4EB 240
	3	2,5	3	2,5	0,46	11	32948
	3	2	3	2	0,35	12,5	T2EE 240
	4	3	4	3	0,46	26,5	32048
	5	4	4	3	0,43	83,5	32248

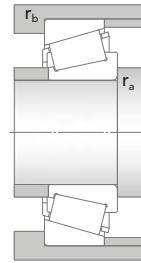
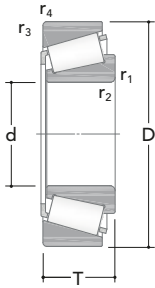

TS

Main dimensions			Basic load ratings		Fatigue load limit C_u	Speed ratings		Designation
d	D	T	Dynamic C	Static C_0		Reference	Limiting	
[mm]			[kN]			[rpm]		
242	406	97	1413	2507	215,00	980	-	332255
255	560	123	1819	2688	225,00	700	-	328213
260	400	87	1234	2210	189,00	1000	1200	32052
	400	98	1433	2564	227,00	1020	-	329066
	410	95	1412	2595	224,00	1010	-	332551
	480	137	2369	3638	301,00	860	1050	32252
	540	109	2128	3063	249,00	790	1120	332973
	540	113	2121	3007	254,00	820	-	30352
280	380	63,5	964	1641	145,00	1100	1210	32956
	420	87	1295	2359	200,00	960	1110	32056
300	420	76	1121	2243	186,00	920	1200	32960
	460	100	1627	3010	244,00	870	1050	32060
	540	149	2976	4812	360,00	780	950	32260
320	440	76	1159	2372	192,00	870	1030	32964
	480	100	1667	3079	252,00	830	970	32064
	620	141	2811	4584	365,00	630	-	332303
340	460	76	1172	2416	195,00	810	1100	32968
360	480	76	1202	2521	206,00	770	1000	32972
	680	165	3675	6237	460,00	570	-	332302
460	860	210	5596	10293	689,00	450	580	332304
560	1080	265	9070	15804	1012,00	250	-	334018
680	1000	190	5677	12573	808,00	320	440	332787

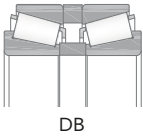

DB

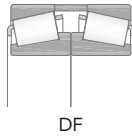

DF

Dimensions					Factor	Mass	Designation
d	r _{1,2min}	r _{3,4min}	r _{amax}	r _{bmax}	e		
[mm]						[kg]	
242	4	4	3	3	0,43	49	332255
255	6	6	5	5	0,88	123	328213
260	5	4	5	4	0,43	38	32052
	4	1,5	3	-	0,30	42,5	329066
	5	5	4	4	0,37	45,5	332551
	6	5	5	4	0,43	105	32252
	6	6	5	5	0,35	107	332973
	6	6	5	5	0,35	110	30352
280	3	2,5	3	2,5	0,43	20	32956
	5	4	5	4	0,46	40,5	32056
300	4	3	4	3	0,4	31,5	32960
	5	4	5	4	0,43	58	32060
	6	5	5	4	0,43	140	32260
320	4	3	4	3	0,43	33,5	32964
	5	4	5	4	0,46	64	32064
	7,5	7,5	7	7	0,60	180	332303
340	4	3	4	3	0,44	35	32968
360	4	3	4	3	0,46	37	32972
	7,5	7,5	6	6	0,60	260	332302
460	7,5	7,5	6	6	0,57	510	332304
560	9,5	9,5	8	8	0,43	1060	334018
680	6	6	5	5	0,43	485	332787

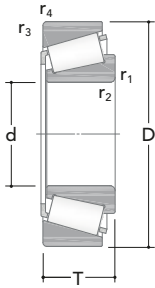

TS

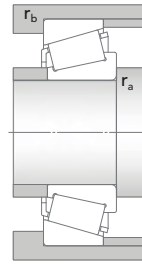

Main dimensions			Basic load ratings		Fatigue load limit	Speed ratings		Designation
d	D	T	Dynamic C	Static C ₀	C _u	Reference	Limiting	
[mm]			[kN]			[rpm]		
710	950	113	2861	6579	448,00	320	470	332890
900	1180	122	3931	9157	585,00	240	350	328214

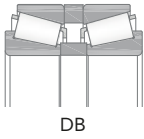

DB

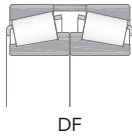

DF

Dimensions					Factor	Mass	Designation
d	r _{1,2min}	r _{3,4min}	r _{amax}	r _{bmax}	e		
[mm]						[kg]	
710	6	6	5	5	0,44	200	332890
900	6	6	5	5	0,40	340	328214

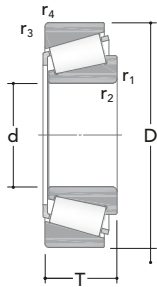

TS

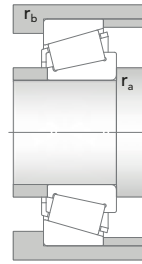

Main dimensions			Basic load ratings		Fatigue load limit C_u	Speed ratings		Designation Standard design
d	D	T	Dynamic C	Static C_0		Reference	Limiting	
[mm]/[in]			[kN]			[rpm]		
14,989 0,590	34,989 1,378	10,998 0,433	16,5	13	1,31	15500	18900	4059/4138
15,875 0,625	41,275 1,625	14,288 0,563	21,8	21	2,17	17910	19500	03062/162
	42,862 1,688	14,288 0,563	21	17	1,80	11500	14580	11590/520
17,462 0,688	39,878 1,57	13,843 0,545	25,9	21	2,09	13560	16500	11749/710
19,05 0,75	45,237 1,781	15,494 0,61	33,5	28	2,90	11700	15200	11949/910
	49,225 1,938	18,034 0,71	47,2	52	5,60	10700	14700	09067/195
	49,225 1,938	19,845 0,781	39,3	40	4,30	10700	14700	09074/195
21,43 0,844	45,237 1,781	15,492 0,610	27,7	31	3,20	10700	14700	12748/710
21,987 0,866	45,237 1,781	15,494 0,61	33,9	31	3,20	10700	14500	12749/710
	45,974 1,81	15,494 0,61	33,9	31	3,20	10700	14500	12749/711
25,4 1	50,292 1,98	14,224 0,56	32,4	30	3,00	10130	12600	44643/610
	50,8 2	15,011 0,591	28	31	3,14	13970	14000	07100/210
	57,15 2,25	17,462 0,688	49,2	46	4,80	8800	10800	15578/520

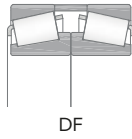
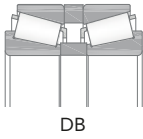

Dimensions					Factor	Mass	Designation
d	r _{1,2min}	r _{3,4min}	r _{amax}	r _{bmax}	e		Standard design
[mm]/[in]						[kg]	
14,989 0,590	0,8	1,3	0,8	1,3	0,46	0,051	4059/4138
15,875 0,625	1,3 0,05	2 0,08	1,3	2	0,31	0,095	03062/162
	1,5 0,06	1,5 0,06	1,5	1,5	0,72	0,1	11590/520
17,462 0,688	1,3 0,05	1,3 0,05	1,3	1,3	0,28	0,082	11749/710
19,05 0,75	1,3 0,05	1,3 0,05	1,3	1,3	0,3	0,12	11949/910
	1,3 0,05	1,3 0,05	1,3	1,3	0,27	0,17	09067/195
	1,5 0,06	1,3 0,05	1,5	1,3	0,27	0,19	09074/195
21,43 0,844	1,3 0,05	1,3 0,05	1,3	1,3	0,31	0,12	12748/710
21,987 0,866	1,3 0,05	1,3 0,05	1,3	1,3	0,31	0,12	12749/710
	1,3 0,05	1,3 0,05	1,3	1,3	0,31	0,12	12749/711
25,4 1	1,3 0,05	1,3 0,05	1,3	1,3	0,37	0,13	44643/610
	1,5 0,06	1,5 0,06	1,5	1,5	0,4	0,13	07100/210
	1,3 0,05	1,5 0,06	1,3	1,5	0,35	0,22	15578/520

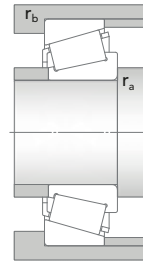
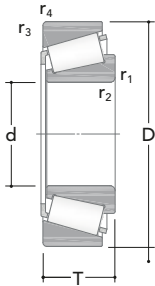

TS

Main dimensions			Basic load ratings		Fatigue load limit C_u	Speed ratings		Designation
d	D	T	Dynamic C	Static C_0		Reference	Limiting	Standard design
[mm]/[in]			[kN]			[rpm]		
25,4	57,15	19,431	49,2	45	5,00	8800	10800	84548/510
1	2,25	0,765						
(cont.)	62	19,05	60,4	58	6,10	8350	10200	15101/245
	2,441	0,75						
26,162	61,912	19,05	60,4	58	6,10	8350	10200	15103/243
1,03	2,438	0,75						
	62	19,05	60,4	58	6,10	8350	10200	15103/245
	2,441	0,75						
26,988	50,292	14,224	32,4	30	3,00	10130	12600	44649/610
1,063	1,98	0,56						
28,575	57,15	19,845	59	55	6,00	9290	10900	1985/1922
1,125	2,25	0,781						
	57,15	19,845	59	55	6,00	9290	10900	1988/1922
	2,25	0,781						
	64,292	21,433	60,4	61	6,80	7700	9690	86647/610
	2,531	0,844						
	73,025	22,225	56,8	70	7,50	6800	8670	02872/820
	2,875	0,875						
29	50,292	14,224	31,6	33	3,35	9940	11900	45449/410
1,142	1,98	0,56						
30,162	64,292	21,433	60,4	61	6,80	7700	9690	86649/610
1,188	2,531	0,844						
	68,262	22,225	66,3	69	7,90	7300	9100	88043/010
	2,688	0,875						
31,75	59,131	15,875	43	42	4,30	8790	10100	67048/010
1,25	2,328	0,625						

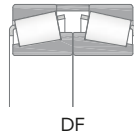
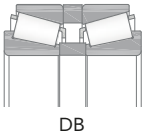

Dimensions					Factor	Mass	Designation
d	r _{1,2min}	r _{3,4min}	r _{amax}	r _{bmax}	e		Standard design
[mm]/[in]						[kg]	
25,4 1	1,5 0,06	1,5 0,06	1,5	1,5	0,54	0,24	84548/510
(cont.)	0,8 0,03	1,3 0,05	0,8	1,3	0,35	0,31	15101/245
26,162 1,03	0,8 0,03	2 0,08	0,8	2	0,35	0,29	15103/243
	0,8 0,03	1,3 0,05	0,8	1,3	0,35	0,29	15103/245
26,988 1,063	3,5 0,14	1,3 0,05	3,3	1,3	0,37	0,11	44649/610
28,575 1,125	0,8 0,03	1,5 0,06	0,8	1,5	0,33	0,23	1985/1922
	3,5 0,14	1,5 0,06	3,3	1,5	0,33	0,22	1988/1922
	1,5 0,06	1,5 0,06	1,5	1,5	0,54	0,35	86647/610
	0,8 0,03	3,3 0,13	0,8	3,1	0,46	0,49	02872/820
29 1,142	3,5 0,14	1,3 0,05	3,3	1,3	0,37	0,11	45449/410
30,162 1,188	1,5 0,06	1,5 0,06	1,5	1,5	0,54	0,33	86649/610
	2,3 0,09	1,5 0,06	2,3	1,5	0,54	0,41	88043/010
31,75 1,25	3,6 0,14	1,3 0,05	3,4	1,3	0,4	0,18	67048/010

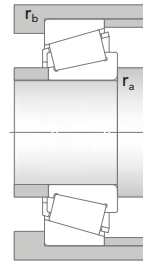
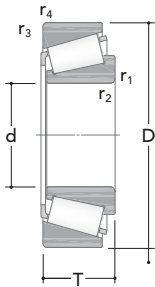

TS

Main dimensions			Basic load ratings		Fatigue load limit C_u	Speed ratings		Designation Standard design
d	D	T	Dynamic C	Static C_0		Reference	Limiting	
[mm]/[in]			[kN]			[rpm]		
31,75	61,912	18,161	60,4	58	6,10	8350	10200	15123/243
1,25	2,438	0,715						
(cont.)	62	18,161	60,4	58	6,10	8350	10200	15123/245
	2,441	0,715						
	73,025	29,37	86,4	94	10,50	6930	8300	88542/510
	2,875	1,156						
33,338	68,262	22,225	66,3	69	7,90	7300	9100	88048/010
1,313	2,688	0,875						
34,925	65,088	18,034	58,6	57	6,20	7920	9400	48548/510
1,375	2,563	0,71						
	65,088	18,034	58,6	57	6,20	7920	9400	48548/510
	2,563	0,71						
	69,012	19,845	66	68	7,28	7200	9100	14137/276
	2,717	0,781						
	72,233	25,4	81,8	90	10,00	6700	8300	88649/610
	2,844	1						
	73,025	23,812	90	89	9,70	7170	8600	25877/821
	2,875	0,938						
	73,025	26,988	93,9	93	10,40	7320	8600	23690/620
	2,875	1,063						
	76,2	29,37	81,9	100	11,20	6500	8590	31594/520
	3	1,156						
	76,2	29,37	96,4	107	11,70	6510	8200	89446/410
	3	1,156						
34,988	59,131	15,875	41	44	4,50	7990	10300	68149/110
1,378	2,328	0,625						
36,512	76,2	29,37	96,4	107	11,70	6510	8200	89449/410
1,438	3	1,156						

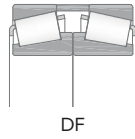
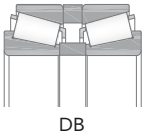

Dimensions					Factor	Mass	Designation
d	r _{1,2min}	r _{3,4min}	r _{amax}	r _{bmax}	e		Standard design
[mm]/[in]						[kg]	
31,75	4	2	3,8	2	0,35	0,24	15123/243
1,25	0,16	0,08					
(cont.)	4	1,3	3,8	1,3	0,35	0,24	15123/245
	0,16	0,05					
	1,3	3,3	1,3	3,1	0,54	0,62	88542/510
	0,05	0,13					
33,338	0,8	1,5	0,8	1,5	0,54	0,38	88048/010
1,313	0,03	0,06					
34,925	0,8	1,3	0,8	1,3	0,37	0,26	48548/510
1,375	0,03	0,05					
	3,5	1,3	3	1,3	0,37	0,25	48548/510
	0,14	0,05					
	1,5	1,3	1,5	1,3	0,37	0,34	14137/276
	0,06	0,05					
	2,3	2,3	2,3	2,3	0,54	0,5	88649/610
	0,09	0,09					
	1,5	0,8	1,5	0,8	0,3	0,47	25877/821
	0,06	0,03					
	3,5	1,5	3,3	1,5	0,37	0,52	23690/620
	0,14	0,06					
	1,5	3,3	1,5	3,1	0,4	0,63	31594/520
	0,06	0,13					
	3,5	3,3	3,3	3,1	0,54	0,66	89446/410
	0,14	0,13					
34,988	3,5	1,3	3,3	1,3	0,43	0,17	68149/110
1,378	0,14	0,05					
36,512	3,5	3,3	3,3	3,1	0,54	0,64	89449/410
1,438	0,14	0,13					

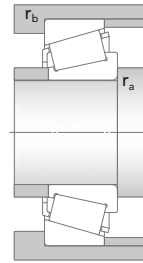
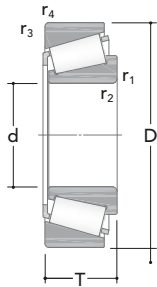

TS

Main dimensions			Basic load ratings		Fatigue load limit C_u	Speed ratings		Designation Standard design
d	D	T	Dynamic C	Static C_0		Reference	Limiting	
[mm]/[in]			[kN]			[rpm]		
38,1	65,088	18,034	53,2	57	6,10	7300	9500	29748/710
1,5	2,563	0,71						
	65,088	18,034	53,2	57	6,10	7300	9500	29749/710
	2,563	0,71						
	65,088	19,812	53,2	57	6,10	7300	9500	29749/711
	2,563	0,78						
	76,2	23,812	91,2	93	10,40	6760	8600	2788/2720
	3	0,938						
	79,375	29,37	113,1	111	12,40	6500	7800	3490/3420
	3,125	1,156						
	82,55	29,37	107,1	118	13,40	6250	7000	801346/310
	3,25	1,156						
	82,55	29,37	107,1	118	13,40	6250	7000	801346/310
	3,25	1,156						
	88,5	26,988	124,8	114	13,20	6000	7700	418/414
	3,484	1,063						
41,275	73,431	19,558	67,8	69	7,54	6980	8500	501349/310
1,625	2,891	0,77						
	73,431	21,43	67,8	69	7,54	6980	8500	501349/314
	2,891	0,844						
	76,2	18,009	56,4	56	6,10	6500	7900	11163/300
	3	0,709						
	76,2	18,009	56,4	56	6,10	6500	7900	11162/300
	3	0,709						
	76,2	22,225	84,7	86	9,66	6400	7800	24780/720
	3	0,875						
	82,55	26,543	92	91	10,70	6150	7600	802048/011
	3,25	1,045						
	88,9	30,162	115	127	14,60	5300	6600	803146/110
	3,5	1,188						

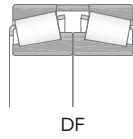
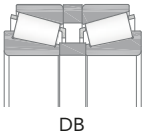

Dimensions					Factor	Mass	Designation	
d	r _{1,2min}	r _{3,4min}	r _{amax}	r _{bmax}	e		Standard design	
[mm]/[in]						[kg]		
38,1	2,3	1,3	2,3	1,3	0,33	0,23	29748/710	
1,5	0,09	0,05						
	2,3	1,3	2	1,3	0,33	0,24	29749/710	
	0,09	0,05						
	2,3	1,3	2,3	1,3	0,33	0,24	29749/711	
	0,09	0,05						
	3,5	3,3	3,3	3,1	0,3	0,5	2788/2720	
	0,14	0,13						
	3,5	3,3	3,3	3,1	0,37	0,67	3490/3420	
	0,14	0,13						
	2,3	3,3	2,3	3,1	0,54	0,78	801346/310	
0,09	0,13							
0,8	3,3	0,8	3,1	0,54	0,78	801346/310		
0,03	0,13							
3,5	1,5	3,3	1,5	0,26	0,83	418/414		
0,14	0,06							
41,275	3,5	0,8	3,3	0,8	0,4	0,34	501349/310	
	1,625	0,14	0,03					
		3,5	0,8	3,3	0,8	0,4	0,36	501349/314
		0,14	0,03					
		0,8	1,5	0,8	1,5	0,48	0,34	11163/300
		0,03	0,06					
		1,5	1,5	1,5	1,5	0,48	0,34	11162/300
		0,06	0,06					
		3,5	0,8	3,3	0,8	0,4	0,43	24780/720
		0,14	0,03					
3,5		3,3	3,3	3,1	0,54	0,62	802048/011	
0,14	0,13							
3,5	3,3	3	3	0,54	0,9	803146/110		
0,14	0,13							

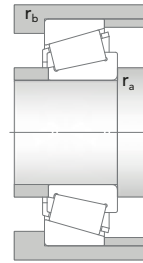
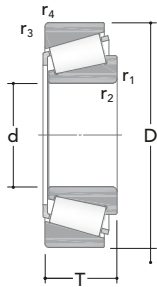

TS

Main dimensions			Basic load ratings		Fatigue load limit C_u	Speed ratings		Designation Standard design
d	D	T	Dynamic C	Static C_0		Reference	Limiting	
[mm]/[in]			[kN]			[rpm]		
42,875 1,688	82,931 3,265	23,812 0,938	100,1	107	11,70	6190	7700	25577/520
	82,931 3,265	26,988 1,063	100,1	107	12,00	6190	7700	25577/523
44,45 1,75	82,931 3,265	23,812 0,938	100,1	107	11,70	6190	7700	25580/520
	83,058 3,27	23,876 0,94	100,1	107	11,70	6190	7700	25580/522
	82,931 3,265	26,988 1,063	100,1	107	11,70	6190	7700	25580/523
	88,9 3,5	30,162 1,188	115	127	14,60	5300	6600	803149/110
	95,25 3,75	30,958 1,219	109	97	11,30	4800	6130	53178/377
	95,25 3,75	30,958 1,219	124,2	121	14,00	4760	6090	903249/210
	104,775 4,125	36,512 1,438	182	206	22,20	4630	5700	807040/010
	107,95 4,25	36,512 1,438	185	193	21,30	4940	5900	535/532 X
	111,125 4,375	38,1 1,5	185	193	21,30	4940	5900	535/532 A
45,237 1,781	87,312 3,438	30,162 1,188	127	133	15,00	5800	7100	3585/3525
45,242 1,781	73,431 2,891	19,558 0,77	65,4	75	8,15	6500	7900	102949/910
	77,788 3,063	19,842 0,781	67,4	71	7,54	6230	7700	603049/011

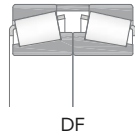
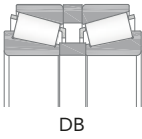

Dimensions					Factor	Mass	Designation
d	r _{1,2min}	r _{3,4min}	r _{amax}	r _{bmax}	e		Standard design
[mm]/[in]						[kg]	
42,875	3,5	0,8	3,3	0,8	0,33	0,57	25577/520
1,688	0,14	0,03					
	3,5	2,3	3,3	2,3	0,33	0,57	25577/523
	0,14	0,09					
44,45	3,5	0,8	3,3	0,8	0,33	0,57	25580/520
1,75	0,14	0,03					
	3,5	2	3,3	2	0,33	0,57	25580/522
	0,14	0,08					
	3,5	2,3	3,3	2,3	0,33	0,57	25580/523
	0,14	0,09					
	3,5	3,3	3,3	3,1	0,54	0,85	803149/110
	0,14	0,13					
	2	2,3	2	2,3	0,75	0,93	53178/377
	0,08	0,09					
	3,5	0,8	3,3	0,8	0,75	1	903249/210
	0,14	0,03					
	3,5	3,3	3,3	3,1	0,48	1,5	807040/010
	0,14	0,13					
	3,5	3,3	3,3	3,1	0,3	1,7	535/532 X
	0,14	0,13					
	3,5	3,3	3,3	3,1	0,3	1,85	535/532 A
	0,14	0,13					
45,237	3,5	3,3	3,3	3,1	0,31	0,85	3585/3525
1,781	0,14	0,13					
45,242	3,5	0,8	3,3	0,8	0,3	0,31	102949/910
1,781	0,14	0,03					
	3,5	0,8	3,3	0,8	0,43	0,37	603049/011
	0,14	0,03					

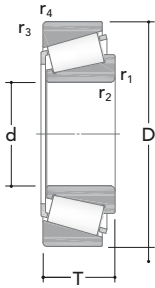

TS

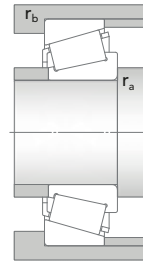

Main dimensions			Basic load ratings		Fatigue load limit C_u	Speed ratings		Designation Standard design
d	D	T	Dynamic C	Static C_0		Reference	Limiting	
[mm]/[in]			[kN]			[rpm]		
45,618	82,931	26,988	100,1	107	11,70	6190	7700	25590/523
1,796	3,265	1,063						
	83,058	23,876	100,1	107	11,70	6190	7700	25590/522
	3,27	0,94						
46,038	79,375	17,462	60	62	6,80	6370	7600	18690/620
1,813	3,125	0,688						
	85	20,638	88,1	82	9,20	6170	7000	359/354 X
	3,347	0,813						
47,625	88,9	20,638	95,3	92	10,40	5730	6900	369/362 A
1,875	3,5	0,813						
	95,25	30,162	132	146	17,30	5230	6300	804846/810
	3,75	1,188						
	101,6	34,925	183	190	21,60	5140	6300	528/522
	4	1,375						
49,212	114,3	44,45	226	225	25,00	4550	5800	65390/320
1,938	4,5	1,75						
50,8	88,9	20,638	95,3	92	10,40	5730	6900	368/362 A
2	3,5	0,813						
	90	25	95,3	92	10,40	5730	6900	368/362 X
	3,543	0,984						
	93,264	30,162	135	147	17,00	5100	6100	3780/3720
	3,672	1,188						
	104,775	36,512	182	206	22,20	4630	5700	807046/010
	4,125	1,438						
	104,775	39,688	197	226	25,00	4850	5800	4580/4535
	4,125	1,563						
53,975	88,9	19,05	72,2	77	9,00	5500	6600	806649/610
2,125	3,5	0,75						

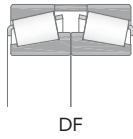
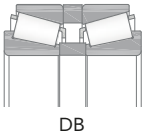

Dimensions					Factor	Mass	Designation
d	r _{1,2min}	r _{3,4min}	r _{amax}	r _{bmax}	e		Standard design
[mm]/[in]						[kg]	
45,618	3,5	2,3	3,3	2,3	0,33	0,59	25590/523
1,796	0,14	0,09					
	3,5	2	3,3	2	0,33	0,55	25590/522
	0,14	0,08					
46,038	2,8	1,5	2,6	1,5	0,37	0,33	18690/620
1,813	0,11	0,06					
	2,3	1,5	2,3	1,5	0,31	0,49	359/354 X
	0,09	0,06					
47,625	2,3	1,3	2,3	1,3	0,31	0,55	369/362 A
1,875	0,09	0,05					
	3,5	3,3	3,3	3,1	0,54	0,95	804846/810
	0,14	0,13					
	8	3,3	7	3,1	0,28	1,25	528/522
	0,31	0,13					
49,212	3,5	3,3	3,3	3,1	0,43	2,2	65390/320
1,938	0,14	0,13					
50,8	3,5	1,3	3,3	1,3	0,31	0,5	368/362 A
2	0,14	0,05					
	3,5	2	3,3	2	0,31	0,58	368/362 X
	0,14	0,08					
	3,5	3,3	3,3	3,1	0,33	0,87	3780/3720
	0,14	0,13					
	3,5	3,3	3,3	3,1	0,48	1,5	807046/010
	0,14	0,13					
	3,5	3,3	3,3	3,1	0,33	1,65	4580/4535
	0,14	0,13					
53,975	2,3	2	2,3	2	0,54	0,44	806649/610
2,125	0,09	0,08					

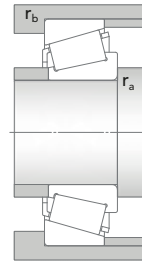
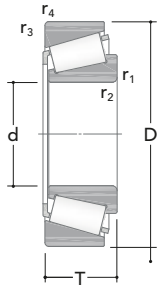

TS

Main dimensions			Basic load ratings		Fatigue load limit C_u	Speed ratings		Designation Standard design
d	D	T	Dynamic C	Static C_0		Reference	Limiting	
[mm]/[in]			[kN]			[rpm]		
53,975	95,25	27,783	128	136	16,00	5100	6400	33895/821
2,125	3,75	1,094						
(cont.)	95,25	27,783	128	136	16,00	5100	6400	33895/822
	3,75	1,094						
	107,95	36,512	182	189	21,70	4930	5900	539/532 X
	4,25	1,438						
	111,125	38,1	182	189	21,70	4930	5900	539/532 A
	4,375	1,5						
	123,825	36,512	174	158	19,80	3800	4900	72212/487
	4,875	1,438						
57,15	96,838	21	100,8	103	11,50	4980	6200	387/382 A
2,25	3,813	0,827						
	104,775	30,162	151	159	18,70	4770	5700	462/453 X
	4,125	1,188						
	112,712	30,162	177	206	23,40	4200	5300	39581/520
	4,438	1,188						
	119,985	32,75	177	206	23,40	4200	5300	39580/528
	4,724	1,289						
	119,985	32,75	177	206	23,40	4200	5300	39581/528
	4,724	1,289						
60,325	130,175	36,512	188	180	22,40	3400	4340	911245/210
2,375	5,125	1,438						
61,912	146,05	41,275	200	237	29,00	3000	3960	913842/810
2,438	5,75	1,625						
	146,05	41,275	200	237	29,00	3000	3960	913843/810
	5,75	1,625						
63,5	112,712	30,162	151	184	21,10	4460	5400	3982/3920
2,5	4,438	1,188						

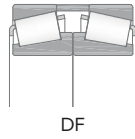
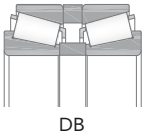

Dimensions					Factor	Mass	Designation
d	r _{1,2min}	r _{3,4min}	r _{amax}	r _{bmax}	e		Standard design
[mm]/[in]						[kg]	
53,975	1,5	2,3	1,5	2,3	0,33	0,8	33895/821
2,125	0,06	0,09					
(cont.)	1,5	0,8	1,5	0,8	0,33	0,81	33895/822
	0,06	0,03					
	3,5	3,3	3,3	3,1	0,3	1,45	539/532 X
	0,14	0,13					
	3,5	3,3	3,3	3,1	0,3	1,55	539/532 A
	0,14	0,13					
	3,5	3,3	3,3	3,1	0,75	2	72212/487
	0,14	0,13					
57,15	3,5	0,8	3,3	0,8	0,35	0,59	387/382 A
2,25	0,14	0,03					
	2,3	3,3	2,3	3,1	0,33	1,05	462/453 X
	0,09	0,13					
	8	3,3	7	3,1	0,33	1,35	39581/520
	0,31	0,13					
	3,5	0,8	3,3	0,8	0,33	1,75	39580/528
	0,14	0,03					
	8	0,8	7	0,8	0,33	1,75	39581/528
	0,31	0,03					
60,325	5	3,3	4,6	3,1	0,83	2,1	911245/210
2,375	0,2	0,13					
61,912	3,5	3,3	3,3	3,1	0,79	3,2	913842/810
2,438	0,14	0,13					
	7	3,3	6,6	3,1	0,79	3,15	913843/810
	0,28	0,13					
63,5	3,5	3,3	3,3	3,1	0,4	1,25	3982/3920
2,5	0,14	0,13					

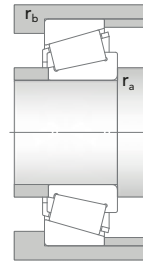
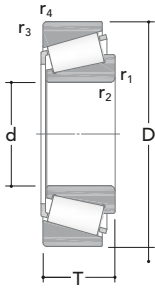

TS

Main dimensions			Basic load ratings		Fatigue load limit C_u	Speed ratings		Designation Standard design
d	D	T	Dynamic C	Static C_0		Reference	Limiting	
[mm]/[in]			[kN]		[rpm]			
65,088 2,563	135,755 5,345	53,975 2,125	358	405	44,90	3600	4700	6379/6320
66,675 2,625	112,712 4,438	30,162 1,188	177	202	23,80	4100	5400	39590/520
	112,712 4,438	30,162 1,188	151	184	21,10	4460	5400	3984/3920
	119,985 4,724	32,75 1,289	177	202	23,80	4100	5400	39590/528
	135,755 5,345	53,975 2,125	358	405	44,90	3600	4700	6386/6320
69,85 2,75	120 4,724	32,545 1,281	189	226	26,70	3900	5100	47487/420
	127 5	36,512 1,438	219	258	29,00	4010	4800	566/563
73,025 2,875	127 5	36,512 1,438	219	258	29,00	4010	4800	567/563
76,2 3	109,538 4,313	19,05 0,75	71,4	102	11,00	4200	4900	814749/710
	127 5	30,162 1,188	172	203	24,00	3700	4500	42687/620
	133,35 5,25	33,338 1,313	200	262	30,00	3460	4100	47678/620
	139,992 5,512	36,512 1,438	225	279	31,00	3450	4200	575/572
	161,925 6,375	49,212 1,938	315	336	38,00	2780	3540	9285/9220
77,788 3,063	127 5	30,163 1,188	172	203	24,00	3700	4500	42690/620

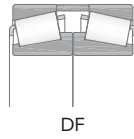
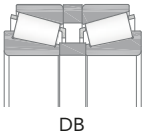

Dimensions					Factor	Mass	Designation
d	r _{1,2min}	r _{3,4min}	r _{amax}	r _{bmax}	e		Standard design
[mm]/[in]						[kg]	
65,088	3,5	3,3	3,3	3,1	0,33	3,7	6379/6320
2,563	0,14	0,13					
66,675	3,5	3,3	3,3	3,1	0,33	1,15	39590/520
2,625	0,14	0,13					
	3,5	3,3	3,3	3,1	0,4	1,15	3984/3920
	0,14	0,13					
	3,5	0,8	3,3	0,8	0,33	1,2	39590/528
	0,14	0,03					
	4,3	3,3	3,9	3,1	0,33	3,65	6386/6320
	0,17	0,13					
69,85	3,5	0,5	3	0,5	0,35	1,5	47487/420
2,75	0,14	0,02					
	3,5	3,3	3,3	3,1	0,37	1,9	566/563
	0,14	0,13					
73,025	3,5	3,3	3,3	3,1	0,37	1,8	567/563
2,875	0,14	0,13					
76,2	1,5	1,5	1,5	1,5	0,5	0,6	814749/710
3	0,06	0,06					
	3,5	3,3	3,3	3,1	0,43	1,45	42687/620
	0,14	0,13					
	6,4	3,3	6	3,1	0,4	1,95	47678/620
	0,25	0,13					
	3,5	3,3	3,3	3,1	0,4	2,45	575/572
	0,14	0,13					
	3,5	3,3	3,3	3,1	0,72	4,4	9285/9220
	0,14	0,13					
77,788	3,5	3,3	3	3	0,43	1,45	42690/620
3,063	0,14	0,13					

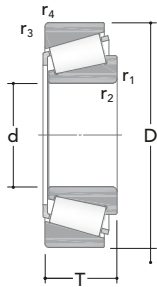

TS

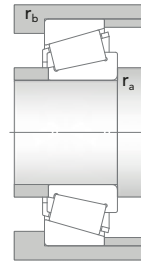

Main dimensions			Basic load ratings		Fatigue load limit C_u	Speed ratings		Designation Standard design
d	D	T	Dynamic C	Static C_0		Reference	Limiting	
[mm]/[in]			[kN]			[rpm]		
82,55 3,25	139,992 5,512	36,512 1,438	225	279	31,00	3450	4200	580/572
92,075 3,625	152,4 6	39,688 1,563	240	308	33,20	3100	3800	598/592 A
95,25 3,75	152,4 6	39,688 1,563	240	308	33,20	3100	3800	594/592 A
	168,275 6,625	41,275 1,625	285	362	39,00	2700	3300	683/672
100,012 3,938	157,162 6,188	36,512 1,438	204	338	37,20	2520	-	52393/618
	161,925 6,375	36,512 1,438	204	338	37,20	2520	-	52393/637
101,6 4	146,05 5,75	21,433 0,844	80	152	16,40	2730	-	521945/910
	157,162 6,188	36,512 1,438	204	338	36,20	2520	-	52400/618
	157,162 6,188	36,512 1,438	204	338	36,20	2520	-	52401/618
	161,925 6,375	36,512 1,438	204	338	36,20	2520	-	52400/637
109,538 4,313	158,75 6,25	23,02 0,906	101,2	161	18,50	2600	-	332727
109,974 4,330	177,8 7	41,275 1,625	246	412	43,00	2420	-	64432/700
	180 7,087	41,275 1,625	246	412	43,00	2420	-	64432/708

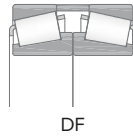
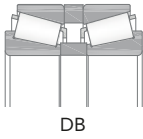

Dimensions					Factor	Mass	Designation
d	r _{1,2min}	r _{3,4min}	r _{amax}	r _{bmax}	e		Standard design
[mm]/[in]						[kg]	
82,55 3,25	3,5 0,14	3,3 0,13	3,3	3,1	0,4	2,2	580/572
92,075 3,625	3,5 0,14	3,3 0,13	3,3	3,1	0,44	2,7	598/592 A
95,25 3,75	3,5 0,14	3,3 0,13	3,3	3,1	0,44	2,55	594/592 A
	3,5 0,14	3,3 0,13	3,3	3,1	0,48	3,75	683/672
100,012 3,938	3,5	3,3	3	3	0,48	2,45	52393/618
	3,5	3,3	3	3	0,48	2,8	52393/637
101,6 4	1,5	1,5	1,5	1,5	0,4	1,15	521945/910
	3,5	3,3	3	3	0,48	2,45	52400/618
	8	3,3	7	3	0,48	2,45	52401/618
	3,5	3,3	3	3	0,48	2,65	52400/637
109,538 4,313	5	3,3	3	3	0,6	1,35	332727
109,974 4,330	3,5	3,3	3	3	0,52	3,7	64432/700
	3,5	3,3	3	3	0,52	3,9	64432/708

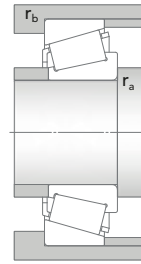
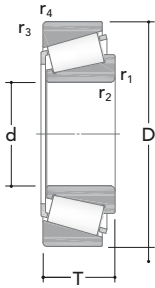

TS

Main dimensions			Basic load ratings		Fatigue load limit C _u	Speed ratings		Designation Standard design
d	D	T	Dynamic C	Static C ₀		Reference	Limiting	
[mm]/[in]			[kN]			[rpm]		
109,987	159,987	34,925	156	348	8,58	2540	-	522548/510
4,330	6,299	1,375						
	159,987	34,925	156	348	8,58	2540	-	522549/510
	6,299	1,375						
109,992	177,8	41,275	246	412	43,00	2500	-	64433/700
4,330	7	1,625						
	180	41,275	246	412	43,00	2500	-	64433/708
	7,087	1,625						
114,3	177,8	41,275	309	416	42,40	2500	3200	64450/700
4,5	7	1,625						
	180	41,275	246	412	42,80	2500	-	64450/708
	7,087	1,625						
	180,975	34,925	227	280	30,00	2500	3100	68450/712
	7,125	1,375						
	190,5	47,625	316	516	55,00	2190	-	71450/750
	7,5	1,875						
	192	47,625	316	516	56,00	2190	-	71450/753
	7,559	1,875						
	212,725	66,675	625	766	81,40	2360	2790	938/932
	8,375	2,625						
	212,725	66,675	624	841	87,00	2010	2650	224346/310
	8,375	2,625						
	228,6	53,975	732	938	97,70	1620	-	926740/710
	9	2,125						
114,976	177,8	41,275	252	413	42,70	2400	-	64452/700
4,527	7	1,625						
	180	41,275	252	413	42,70	2400	-	64452/708
	7,087	1,625						
	212,725	66,675	607	813	90,00	2100	2550	224349/310
	8,375	2,625						

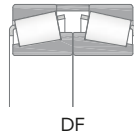
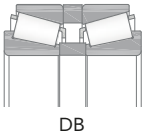

Dimensions					Factor	Mass	Designation
d	r _{1,2min}	r _{3,4min}	r _{amax}	r _{bmax}	e		Standard design
[mm]/[in]						[kg]	
109,987 4,330	7,9	3,3	7	3	0,4	2,2	522548/510
	3,5	3,3	3	3	0,4	2,3	522549/510
109,992 4,330	3,5	3,3	3	3	0,52	3,7	64433/700
	3,5	3,3	3	3	0,52	3,9	64433/708
114,3 4,5	3,5	3,3	3,3	3,1	0,52	3,6	64450/700
	0,14	0,13					
	3,5	3,3	3	3	0,52	3,8	64450/708
	3,5	3,3	3,3	3,1	0,5	2,95	68450/712
	0,14	0,13					
	3,5	3,3	3	3	0,43	5,25	71450/750
	3,5	3,3	3	3	0,43	5,4	71450/753
	7	3,3	6	3	0,33	10	938/932
7	3,3	6	3	0,33	10,5	224346/310	
114,976 4,527	3,5	3,3	3	3	0,75	9,65	926740/710
	9	3,3	8	3	0,52	3,55	64452/700
	9	3,3	8	3	0,52	3,75	64452/708
7	3,3	6	3	0,33	10,5	224349/310	

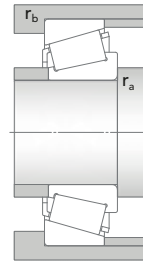
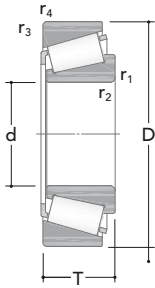

TS

Main dimensions			Basic load ratings		Fatigue load limit C_u	Speed ratings		Designation	
d	D	T	Dynamic C	Static C_0		Reference	Limiting	Standard design	
[mm]/[in]			[kN]			[rpm]			
117,475 4,625	180,975	34,925	181	279	30,00	2410	-	68462/712	
	7,125	1,375	180,975	34,925	181	279	30,00	2410	-
	7,125	1,375							
120,65 4,75	169,862	25,4	133	266	27,00	2420	-	225842/810	
	6,688	1							
	190,5	46,038	394	539	56,00	2430	2740	624749/710	
	7,5	1,813							
	254	77,788	730	1076	106,00	1710	-	228340/310	
	10	3,063							
127 5	169,862	25,4	133	266	27,00	2420	-	225849/810	
	6,688	1							
	182,562	39,688	279	439	44,00	2400	2760	48290/220	
	7,188	1,563							
	196,85	46,038	400	590	59,00	2180	2800	67388/322	
	7,75	1,813							
	215,9	47,625	342	605	63,00	1800	-	74500/850	
	8,5	1,875							
	228,6	53,975	416	619	64,00	1870	-	926747/710	
	9	2,125							
	254	77,788	730	1076	106,00	1710	-	228349/310	
	10	3,063							
133,35 5,25	177,008	25,4	164	277	28,00	2300	3000	327249/210	
	6,969	1							
	190,5	39,688	249	503	50,00	2220	-	48385/320	
	7,5	1,563							
	196,85	46,038	323	588	60,00	2000	3010	67390/322	
	7,75	1,814							
	196,85	46,038	323	588	60,00	2000	2930	67391/322	
	7,75	1,813							

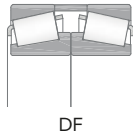
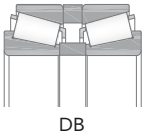

Dimensions					Factor	Mass	Designation
d	r _{1,2min}	r _{3,4min}	r _{amax}	r _{bmax}	e		Standard design
[mm]/[in]						[kg]	
117,475 4,625	3,5	3,3	3	3	0,5	2,8	68462/712
	8	3,3	7	3	0,5	2,8	68463/712
120,65 4,75	1,5	1,5	1	1	0,33	1,85	225842/810
	3,5	1,5	3	1	0,43	4,85	624749/710
	9,7	6,4	9	6	0,33	19,5	228340/310
127 5	1,5	1,5	1	1	0,33	1,6	225849/810
	3,5	3,3	3	3	0,3	3,3	48290/220
	3,5	3,3	3,3	3,1	0,35	5,15	67388/322
	0,14	0,13					
	3,5	3,3	3	3	0,48	7	74500/850
	3,5	3,3	3	3	0,75	8,9	926747/710
	9,7	6,4	9	6	0,33	18,5	228349/310
133,35 5,25	1,5	1,5	1,5	1,5	0,35	1,75	327249/210
	0,06	0,06					
	3,5	3,3	3	3	0,33	3,55	48385/320
	3,5	3,3	3	3	0,35	4,7	67390/322
	8	3,3	7	3	0,35	4,65	67391/322

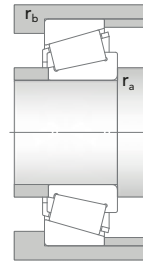
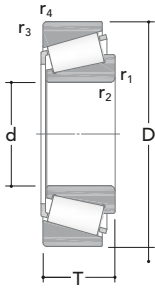

TS

Main dimensions			Basic load ratings		Fatigue load limit C_u	Speed ratings		Designation Standard design
d	D	T	Dynamic C	Static C_0		Reference	Limiting	
[mm]/[in]			[kN]			[rpm]		
133,35	215,9	47,625	342	605	63,00	1800	-	74525/850
5,25	8,5	1,875						
(cont.)	234,95	63,5	676	912	90,30	2000	2450	95525/925
	9,25	2,5						
	234,95	63,5	547	893	91,00	1800	-	95528/925
	9,25	2,5						
136,525	190,5	39,688	249	503	49,00	2220	-	48393/320
5,375	7,5	1,563						
	190,5	39,688	249	503	49,00	2220	-	48393/320
	7,5	1,563						
139,7	215,9	47,625	342	605	63,00	1800	-	74550/850
5,5	8,5	1,875						
	236,538	57,15	507	841	87,40	1720	-	231132/110
	9,313	2,25						
142,875	200,025	41,275	250	518	52,00	1960	-	48685/620
5,625	7,875	1,625						
146,05	193,675	28,575	173	358	36,00	2050	-	36690/620
5,75	7,625	1,125						
	193,675	28,575	173	358	36,00	2050	-	36691/620
	7,625	1,125						
	200,025	41,275	250	518	52,00	1960	-	332808
	7,874	1,625						
	241,3	57,15	476	840	82,00	1730	-	82576/950
	9,5	2,25						
	304,8	88,9	839	1164	114,00	1250	-	932145/110
	12	3,5						
149,225	236,538	57,15	623	848	86,70	2040	2300	231148/110
5,875	9,313	2,25						

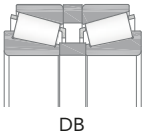

DB

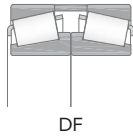

DF

Dimensions					Factor	Mass	Designation
d	r _{1,2min}	r _{3,4min}	r _{amax}	r _{bmax}	e		Standard design
[mm]/[in]						[kg]	
133,35 5,25	3,5	3,3	3	3	0,48	6,5	74525/850
(cont.)	9,7	3,3	9	3	0,37	11,5	95525/925
	4,8	3,3	4	3	0,37	11,5	95528/925
136,525 5,375	5,5	3,3	5	3	0,33	3,3	48393/320
	3,5	3,3	3	3	0,33	3,3	48393/320
139,7 5,5	3,5	3,3	3	3	0,48	6	74550/850
	3,5	3,3	3	3	0,31	10	231132/110
142,875 5,625	3,5	3,3	3	3	0,3	3,8	48685/620
146,05 5,75	1,5	1,5	1	1	0,37	2,3	36690/620
	4,8	1,5	4	1	0,37	2,3	36691/620
	3,5	3,3	3	3	0,33	3,75	332808
	3,5	3,3	3	3	0,44	10	82576/950
	6,4	6,4	6	6	0,72	28	932145/110
149,225 5,875	6,4 0,25	3,3 0,13	6	3,1	0,31	9,05	231148/110

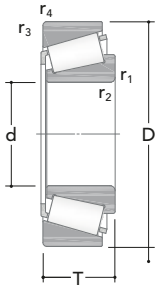

TS

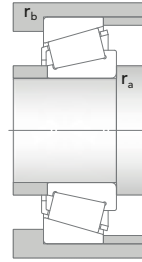

Main dimensions			Basic load ratings		Fatigue load limit C_u	Speed ratings		Designation Standard design
d	D	T	Dynamic C	Static C_0		Reference	Limiting	
[mm]/[in]			[kN]		[rpm]			
152,4	222,25	46,83	399	638	61,00	2000	2500	231649/610
6	8,75	1,844	584	990	95,50	1630	-	99600/100
	254	66,675						
	10	2,625						
155,575	336,55	85,725	837	1183	118,00	1200	-	328833
6,125	13,25	3,375	170	280	27,00	1980	2500	432348/310
	8,094	0,938						
	225,425	41,275						
8,875	1,625	262	582	56,00	1680	-	46780/720	
165,1	225,425	41,275	262	582	56,00	1680	-	46790/720
6,5	8,875	1,625	1187	1715	155,00	1270	1670	437549/510
	336,55	92,075						
	13,25	3,625						
177,8	227,012	30,162	234	424	40,00	1830	2400	36990/920
7	8,938	1,188	489	895	88,00	1550	-	236849/810
	260,35	53,975						
	10,25	2,125						
178,595	265,112	51,595	616	886	84,00	1600	2000	336948/912
7,031	10,438	2,031	616	886	84,00	1600	2000	336949/912
179,934	265,112	51,595						
7,084	10,438	2,031						
184,15	266,7	47,625	372	798	75,00	1440	-	67883/820
7,25	10,5	1,875						

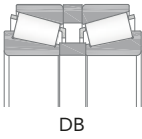

DB

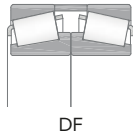

DF

Dimensions					Factor	Mass	Designation
d	r _{1,2min}	r _{3,4min}	r _{amax}	r _{bmax}	e		Standard design
[mm]/[in]						[kg]	
152,4	3,5	1,5	3,3	1,5	0,33	5,85	231649/610
6	0,14	0,06					
	7	3,3	6	3	0,4	12,5	99600/100
155,575	6,4	6,4	6	6	0,79	33,5	328833
6,125							
158,75	4,8	1,5	4,4	1,5	0,37	1,9	432348/310
6,25	0,19	0,06					
	3,5	3,3	3	3	0,37	5,3	46780/720
165,1	3,5	3,3	3	3	0,37	4,75	46790/720
6,5							
	3,3	6,4	3	6	0,37	37	437549/510
177,8	1,5	1,5	1,5	1,5	0,44	2,95	36990/920
7	0,06	0,06					
	3,5	3,3	3	3	0,33	9,35	236849/810
178,595	3,3	3,3	3,1	3,1	0,33	9,55	336948/912
7,031	0,13	0,13					
179,934	3,3	3,3	3,1	3,1	0,33	9,4	336949/912
7,084	0,13	0,13					
184,15	3,5	3,3	3	3	0,48	8,2	67883/820
7,25							

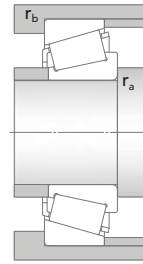
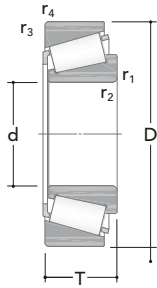

TS

Main dimensions			Basic load ratings		Fatigue load limit C_u	Speed ratings		Designation Standard design
d	D	T	Dynamic C	Static C_0		Reference	Limiting	
[mm]/[in]			[kN]			[rpm]		
187,325	269,875	55,562	475	957	90,80	1500	-	238849/810
7,375	10,625	2,188						
	282,575	50,8	498	701	66,00	1500	1900	87737/111
	11,125	2						
189,738	279,4	52,388	645	991	92,00	1560	1750	239447/410
7,47	11	2,063						
190,475	279,4	52,388	528	985	93,00	1500	1950	239449/410
7,5	11	2,063						
190,5	266,7	47,625	372	798	73,70	1440	-	67885/820
7,5	10,5	1,875						
	282,575	50,8	498	701	66,00	1500	1900	87750/111
	11,125	2						
191,237	279,4	52,388	528	985	95,00	1500	1950	239448/410
7,529	11	2,063						
196,85	241,3	23,812	190	319	29,00	1750	2200	639249/210
7,75	9,5	0,938						
	257,175	39,688	337	665	57,60	1670	2000	739749/710
	10,125	1,563						
200,025	276,225	42,862	477	781	72,00	1580	1800	241147/110
7,875	10,875	1,688						
203,2	261,142	28,575	218	442	41,30	1460	-	641149/110
8	10,281	1,125						
	282,575	46,038	382	835	76,00	1340	-	67983/920
	11,125	1,813						

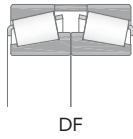
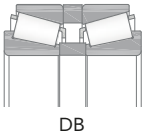

Dimensions					Factor	Mass	Designation
d	r _{1,2min}	r _{3,4min}	r _{amax}	r _{bmax}	e		Standard design
[mm]/[in]						[kg]	
187,325 7,375	3,5	3,3	3	3	0,33	9,85	238849/810
	3,5 0,14	3,3 0,13	3,3	3,1	0,43	9,95	87737/111
189,738 7,47	3,3	3,3	3	3	0,33	11	239447/410
190,475 7,5	3,3 0,13	3,3 0,13	3,1	3,1	0,33	9,5	239449/410
190,5 7,5	3,5	3,3	3	3	0,48	8,2	67885/820
	3,5 0,14	3,3 0,13	3,3	3,1	0,43	9,55	87750/111
191,237 7,529	3,3 0,13	3,3 0,13	3,1	3,1	0,33	9,2	239448/410
196,85 7,75	1,5 0,06	1,5 0,06	1,5	1,5	0,43	2,1	639249/210
	3,5 0,14	3,3 0,13	3,3	3,1	0,44	5,35	739749/710
200,025 7,875	3,5 0,14	3,3 0,13	3,3	3,1	0,31	7,7	241147/110
203,2 8	1,5	1,5	1,5	1,5	0,4	3,75	641149/110
	3,5	3,3	3	3	0,5	8,95	67983/920

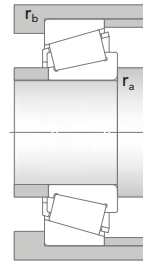
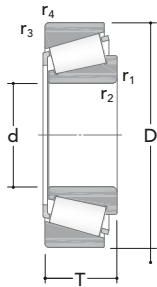

TS

Main dimensions			Basic load ratings		Fatigue load limit C_u	Speed ratings		Designation Standard design
d	D	T	Dynamic C	Static C_0		Reference	Limiting	
[mm]/[in]			[kN]		[rpm]			
203,987 8,031	276,225 10,875	42,862 1,688	477	781	72,00	1580	1800	241148/110
206,375 8,125	282,575 11,125	46,038 1,813	469	828	76,70	1470	1750	67985/920
	336,55 13,25	98,425 3,875	1217	2153	191,00	1200	1580	242649/610
212,725 8,375	285,75 11,25	46,038 1,813	460	844	77,00	1490	1800	742745/710
215,9 8,5	285,75 11,25	46,038 1,813	460	844	77,00	1490	1800	742749/710
216,408 8,52	285,75 11,25	46,038 1,813	460	844	77,00	1490	1800	742747/710
	285,75 11,25	46,038 1,813	328	703	62,00	1360	-	443786
216,713 8,532	285,75 11,25	46,038 1,813	460	844	77,00	1490	1800	742747/710
220,116 8,666	317,5 12,5	47,625 1,875	517	979	90,00	1200	-	245832/810
220,878 8,696	317,5 12,5	47,625 1,875	517	979	90,00	1200	-	245833/810
230,188 9,063	317,5 12,5	47,625 1,875	643	977	90,00	1380	1570	245846/810
231,775 9,125	300,038 11,813	33,338 1,313	266	426	39,00	1390	1650	544091/118

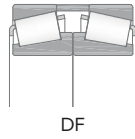
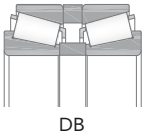

Dimensions					Factor	Mass	Designation
d	r _{1,2min}	r _{3,4min}	r _{amax}	r _{bmax}	e		Standard design
[mm]/[in]						[kg]	
203,987 8,031	3,5 0,14	3,3 0,13	3,3	3,1	0,31	7,2	241148/110
206,375 8,125	3,5 0,14	3,3 0,13	3	3	0,5	8,6	67985/920
	3,3	3,3	3	3	0,33	34	242649/610
212,725 8,375	3,5	3,3	3	3	0,48	8	742745/710
215,9 8,5	3,5	3,3	3	3	0,48	7,9	742749/710
216,408 8,52	3,5 0,14	3,3 0,13	3,3	3,1	0,48	7,9	742747/710
	3,5	3,3	3	3	0,48	7,85	443786
216,713 8,532	3,5 0,14	3,3 0,13	3,3	3,1	0,48	7,85	742747/710
220,116 8,666	3,3	3,3	3	3	0,31	12,5	245832/810
220,878 8,696	3,3	3,3	3	3	0,31	12,5	245833/810
230,188 9,063	3,3	3,3	3	3	0,31	11	245846/810
231,775 9,125	3,5 0,14	3,3 0,13	3,3	3,1	0,4	5,3	544091/118

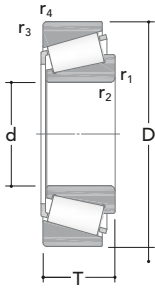

TS

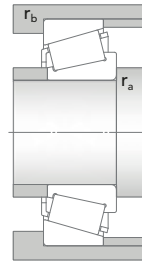

Main dimensions			Basic load ratings		Fatigue load limit C_u	Speed ratings		Designation
d	D	T	Dynamic C	Static C_0		Reference	Limiting	Standard design
[mm]/[in]			[kN]		[rpm]			
231,775	317,5	47,625	643	977	90,00	1380	1570	245848/810
9,125	12,5	1,875						
(cont.)								
247,65	406,4	115,888	1615	3136	256,00	990	-	249949/910
9,75	16	4,563						
254	533,4	133,35	2116	2908	239,00	720	970	332901
10	21	5,25						
	533,4	133,35	1853	2753	228,00	730	950	953749/710
	21	5,25						
255,6	342,9	57,15	800	1398	125,00	1210	1400	349547/510
10,063	13,5	2,25						
255,625	342,945	57,15	658	1388	126,00	1070	-	417708
10,064	13,501	2,25						
	342,945	57,15	658	1388	126,00	1070	-	255-417054
	13,501	2,25						
257,175	342,9	57,15	800	1398	125,00	1210	1400	349549/510
10,125	13,5	2,25						
	358,775	71,438	1022	1767	155,00	1200	1400	249747/710
	14,125	2,813						
263,525	325,438	28,575	272	555	48,00	1290	1500	38880/820
10,375	12,813	1,125						
265	355,6	57,15	647	1404	125,00	1080	-	451347/310
10,433	14	2,25						
266,56	325,438	29,5	205	472	41,80	1180	-	446356
10,500	12,813	1,161						

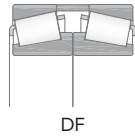
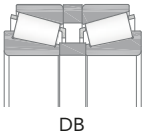

Dimensions					Factor	Mass	Designation
d	r _{1,2min}	r _{3,4min}	r _{amax}	r _{bmax}	e		Standard design
[mm]/[in]						[kg]	
231,775 9,125 (cont.)	3,3	3,3	3	3	0,31	10,5	245848/810
247,65 9,75	6,4	6,4	6	6	0,33	60	249949/910
254 10	6,4	6,4	6	6	0,88	120	332901
	6,4	6,4	6	6	0,94	121	953749/710
255,6 10,063	1,5 0,06	3,3 0,13	1,5	3	0,35	15	349547/510
255,625 10,064	6,4	3,3	6	3	0,35	14	417708
	6,4	3,3	6	3	0,35	14,4	255-417054
257,175 10,125	6,4 0,25	3,3 0,13	6	3	0,35	14	349549/510
	1,5 0,06	3,3 0,13	1,5	3	0,33	21,5	249747/710
263,525 10,375	1,5 0,06	1,5 0,06	1,5	1,5	0,37	5,3	38880/820
265 10,433	3,5	3,3	3	3	0,35	16	451347/310
266,56 10,500	1	1,5	1	1,5	0,37	5,1	446356

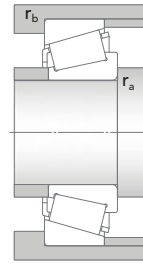
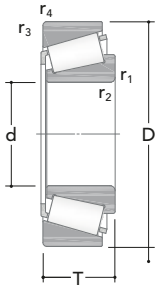

TS

Main dimensions			Basic load ratings		Fatigue load limit C _u	Speed ratings		Designation Standard design
d	D	T	Dynamic C	Static C ₀		Reference	Limiting	
[mm]/[in]			[kN]			[rpm]		
266,7 10,5	325,438 12,813	27,755 1,093	205	472	41,80	1180	-	443884
	355,6 14	57,15 2,25	647	1404	125,00	1080	-	451349/310
292,1 11,5	374,65 14,75	47,625 1,875	618	1129	99,00	1110	1300	555249/210
300 11,811	495,3 19,5	141,288 5,563	2345	4516	358,00	770	1120	258248/210
304,8 12	393,7 15,5	50,8 2	656	1220	104,00	1010	1200	357049/010
	546,1 21,5	171,053 6,734	3075	5560	418,00	730	970	617089
330,2 13	415,925 16,375	47,625 1,875	406	977	79,00	850	-	440009
	482,6 19	85,725 3,375	1201	2535	201,00	770	1030	526130/190
333,375 13,125	469,9 18,5	90,488 3,563	1437	2874	230,00	780	1050	261049/010
343,154 13,51	450,85 17,75	66,675 2,625	1009	2218	179,00	870	1100	361649/610
346,075 13,625	488,95 19,25	95,25 3,75	1533	3153	255,00	820	1100	262749/710
355,6 14	482,6 19	60,32 2,375	565	1205	98,00	760	1130	431884

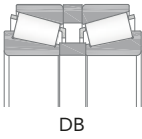

DB

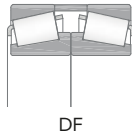

DF

Dimensions					Factor	Mass	Designation
d	r _{1,2min}	r _{3,4min}	r _{amax}	r _{bmax}	e		Standard design
[mm]/[in]						[kg]	
266,7	1,5	1,5	1,5	1,5	0,37	5,1	443884
10,5	3,5	3,3	3	3	0,35	15,5	451349/310
292,1	3,5	3,3	3,3	3,1	0,4	12,5	555249/210
11,5	0,14	0,13					
300	6,4	6,4	6	6	0,33	107	258248/210
11,811							
304,8	6,4	3,3	6	3,1	0,35	14,5	357049/010
12	0,25	0,13					
	8	8	7	7	0,35	170	617089
330,2	3,5	3,5	3	3	0,5	14,3	440009
13	6,4	3,3	6	3	0,4	48,5	526130/190
333,375	6,4	3,3	6	3	0,33	47	261049/010
13,125							
343,154	8,5	3,5	7,5	3,3	0,35	28	361649/610
13,51	0,33	0,14					
346,075	6,4	3,3	6	3,1	0,33	55	262749/710
13,625	0,25	0,13					
355,6	7	7	6,5	6,5	0,48	26,5	431884
14							

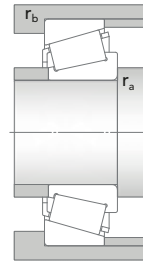
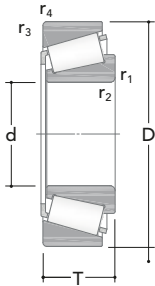

TS

Main dimensions			Basic load ratings		Fatigue load limit C_u	Speed ratings		Designation Standard design
d	D	T	Dynamic C	Static C_0		Reference	Limiting	
[mm]/[in]			[kN]			[rpm]		
380,1 14,961	480 18,898	50 1,969	594	1502	120,00	710	-	380-332420
381 15	479,425 18,875	49,213 1,938	647	1488	121,00	770	1000	865547/512
384,175 15,125	546,1 21,5	104,775 4,125	1865	4092	325,00	720	950	266449/410
403,225 15,875	460,375 18,125	28,575 1,125	249	764	58,60	780	1060	566848/810
406,4 16	508 20	61,912 2,438	829	2143	168,00	680	950	467549/510
	549,275 21,625	85,725 3,375	1471	3072	234,00	680	850	567949/910
	574,675 22,625	76,2 3	943	2029	164,00	640	860	285160/226
	762 30	180,975 7,125	3685	6033	445,00	450	600	969249/210
415,925 16,375	590,55 23,25	114,3 4,5	2121	4736	370,00	620	860	268749/710
430,212 16,938	603,25 23,75	76,2 3	1086	2335	185,00	620	830	241693/375
431,8 17	571,5 22,5	89,694 3,531	1448	3443	266,00	620	780	328284
431,902 17,004	685,698 26,996	177,8 7	3947	8669	584,00	500	730	332900

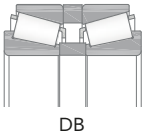

DB

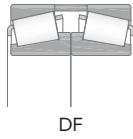

DF

Dimensions					Factor	Mass	Designation
d	r _{1,2min}	r _{3,4min}	r _{amax}	r _{bmax}	e		Standard design
[mm]/[in]						[kg]	
380,1 14,961	6	4	5	3,5	0,5	20,5	380-332420
381 15	6,4 0,25	3,3 0,13	6	3,1	0,5	20	865547/512
384,175 15,125	6,4 0,25	6,4 0,25	6	6	0,33	77	266449/410
403,225 15,875	3,5 0,14	3,3 0,13	3,3	3,1	0,4	6,7	566848/810
406,4 16	3,3	3,3	3	3	0,37	26,5	467549/510
	6,4 0,25	3,3 0,13	6	3,1	0,4	53,5	567949/910
	6,8	3,3	6	3	0,5	53,5	285160/226
	12,7	12,7	12	12	0,94	320	969249/210
415,925 16,375	6,4 0,25	6,4 0,25	6	6	0,33	120	268749/710
430,212 16,938	6,4 0,25	6,4 0,25	6	6	0,52	59	241693/375
431,8 17	6,4 0,25	6,4 0,25	6	6	0,44	60	328284
431,902 17,004	6,4 0,25	6,4 0,25	6	6	0,48	253	332900

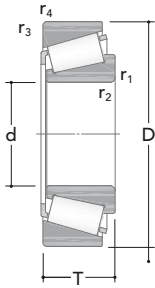

TS

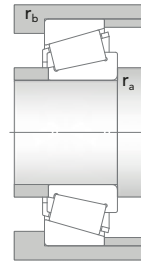

Main dimensions			Basic load ratings		Fatigue load limit C_u	Speed ratings		Designation Standard design
d	D	T	Dynamic C	Static C_0		Reference	Limiting	
[mm]/[in]			[kN]		[rpm]			
447,675 17,625	635 25	120,65 4,75	2361	5466	402,00	540	770	270749/710
457,2 18	573,088 22,563	74,612 2,938	1205	2965	231,00	600	800	570649/610
	603,25 23,75	85,725 3,375	1437	3430	263,00	610	840	770949/910
	615,95 24,25	85,725 3,375	1473	3785	281,00	540	780	272235/210
	660,4 26	91,28 3,594	1778	3605	278,00	540	690	737181/260
479,425 18,875	679,45 26,75	128,588 5,063	2767	6327	453,00	500	750	332529
480 18,898	950 37,402	240 9,449	7033	12551	840,00	380	-	332263
482,6 19	634,873 24,995	80,962 3,188	1468	3642	281,00	580	740	243190/250
488,95 19,25	634,873 24,995	84,138 3,313	1430	3678	263,00	580	750	772748/710
498,323 19,619	634,873 24,995	80,962 3,188	1468	3642	281,00	580	740	243196/243250
498,475 19,625	634,873 24,995	80,962 3,188	1468	3642	271,00	580	740	243196/250
498,653 19,632	634,873 24,995	80,962 3,188	1468	3642	281,00	580	740	243196/250

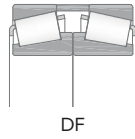
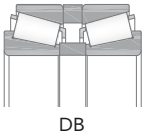

Dimensions					Factor	Mass	Designation
d	r _{1,2min}	r _{3,4min}	r _{amax}	r _{bmax}	e		Standard design
[mm]/[in]						[kg]	
447,675 17,625	6,4 0,25	6,4 0,25	6	6	0,33	120	270749/710
457,2 18	6,4 0,25	6,4 0,25	6	6	0,4	43,5	570649/610
	6,4 0,25	3,3 0,13	6	3,1	0,46	61,5	770949/910
	6,4	6,4	6	6	0,33	72	272235/210
	10,5	6,4	10	6	0,37	91	737181/260
479,425 18,875	6,4	6,4	6	6	0,33	145	332529
480 18,898	9,5	9,5	9	9	0,54	760	332263
482,6 19	6,4 0,25	3,3 0,13	6	3	0,35	67,5	243190/250
488,95 19,25	6,4 0,25	3,3 0,13	6	3,1	0,48	63,5	772748/710
498,323 19,619	6,4	3,3	6	3	0,35	60	243196/243250
498,475 19,625	6,4 0,25	3,3 0,13	6	3,1	0,35	59,5	243196/250
498,653 19,632	6,4 0,25	3,3 0,13	6	3	0,35	59,5	243196/250

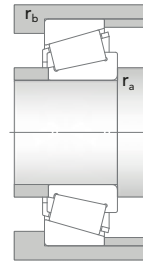
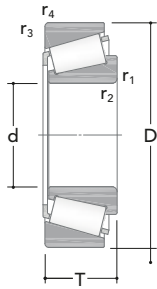

TS

Main dimensions			Basic load ratings		Fatigue load limit C_u	Speed ratings		Designation Standard design
d	D	T	Dynamic C	Static C_0		Reference	Limiting	
[mm]/[in]			[kN]			[rpm]		
520,7 20,5	736,6 29	88,9 3,5	1631	3373	248,00	490	660	982051/900
536,575 21,125	761,873 29,995	146,05 5,75	3325	8090	544,00	440	580	276449/410
	820 32,284	152 5,984	3930	7839	537,00	400	580	328017
539,75 21,25	635 25	50,8 2	774	2145	161,00	520	740	575349/310
549,275 21,625	692,15 27,25	80,963 3,188	1343	3492	252,00	670	960	476549/510
558,8 22	736,6 29	88,108 3,469	1827	4177	303,00	480	650	843220/290
	736,6 29	104,775 4,125	2358	5725	403,00	480	650	377449/410
607,72 23,926	787,4 31	93,662 3,688	2164	5303	380,00	430	590	649239/310
609,6 24	787,4 31	93,662 3,688	2164	5303	380,00	430	530	649240/310
635 25	736,6 29	57,15 2,25	863	2636	187,00	440	600	80780/720
660,4 26	812,8 32	95,25 3,75	1955	5533	385,00	380	490	281147/110
	939,8 37	136,525 5,375	3782	8130	551,00	340	-	332383

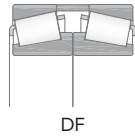
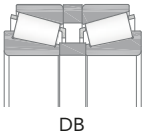

Dimensions					Factor	Mass	Designation
d	r _{1,2min}	r _{3,4min}	r _{amax}	r _{bmax}	e		Standard design
[mm]/[in]						[kg]	
520,7 20,5	6,4 0,25	3,3 0,13	6	3	0,48	100	982051/900
536,575 21,125	6,4 0,25	6,4 0,25	6	6	0,33	208	276449/410
	6	5	5	4	0,43	272	328017
539,75 21,25	6,4 0,25	6,4 0,25	6	6	0,4	27	575349/310
549,275 21,625	6,4 0,25	6,4 0,25	6	6	0,37	67	476549/510
558,8 22	6,4 0,25	6,4 0,25	6	6	0,35	92,5	843220/290
	6,4 0,25	6,4 0,25	6	6	0,35	115	377449/410
607,72 23,926	6,4 0,25	6,4 0,25	6	6	0,37	110	649239/310
609,6 24	6,4 0,25	6,4 0,25	6	6	0,37	110	649240/310
635 25	3,3 0,13	3,3 0,13	3	3	0,44	37	80780/720
660,4 26	6,4 0,25	6,4 0,25	6	6	0,33	105	281147/110
	6,4 0,25	6,4 0,25	6	6	0,4	287	332383

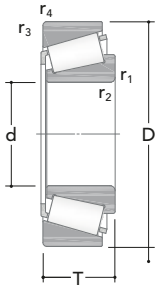

TS

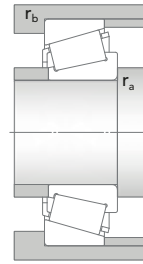

Main dimensions			Basic load ratings		Fatigue load limit C_u	Speed ratings		Designation Standard design
d	D	T	Dynamic C	Static C_0		Reference	Limiting	
[mm]/[in]			[kN]		[rpm]			
660,4 26	1000 39,370	152,4 6	4423	9595	614,00	320	460	334140
(cont.)								
679,45 26,75	901,7 35,5	142,875 5,625	3591	8956	603,00	340	480	281849/810
682,625 26,875	965,2 38	185,738 7,313	5137	12609	793,00	330	-	332283
	1080 42,520	200 7,874	6765	13097	837,00	290	420	332705
685,8 27	876,3 34,5	93,662 3,688	2091	5458	378,00	370	460	655270/345
711,2 28	939,8 37	120,65 4,75	2644	6183	426,00	310	420	328068
723,9 28,5	914,4 36	84,138 3,313	2076	4881	336,00	350	490	755285/360
736,6 29	825,5 32,5	31,75 1,25	425	1384	90,60	370	-	582949/910
749,3 29,5	990,6 39	159,5 6,280	4593	12093	744,00	320	430	283649/610
759,925 29,918	889 35	69,85 2,75	1221	3786	256,00	370	480	483448/418
	889 35	88,9 3,5	1955	6120	410,00	330	-	183448/410
760 29,921	889 35	69,85 2,75	1221	3786	256,00	370	480	483448/418

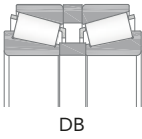

DB

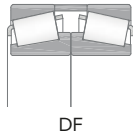

DF

Dimensions					Factor	Mass	Designation
d	r _{1,2min}	r _{3,4min}	r _{amax}	r _{bmax}	e		Standard design
[mm]/[in]						[kg]	
660,4 26	6,4 0,25	6,4 0,25	6	6	0,43	410	334140
(cont.)							
679,45 26,75	9,7	6,4	9	6	0,33	242	281849/810
682,625 26,875	6,4 0,25	6,4 0,25	6	6	0,33	420	332283
	12	12	11	11	0,43	640	332705
685,8 27	6,4 0,25	6,4 0,25	6	6	0,43	130	655270/345
711,2 28	6,4 0,25	6,4 0,25	6	6	0,75	206	328068
723,9 28,5	5,5	6,4 0,25	5	6	0,37	115	755285/360
736,6 29	3,5	3,3	3	3	0,4	22,5	582949/910
749,3 29,5	6,4 0,25	6,4 0,25	6	6	0,33	330	283649/610
759,925 29,918	3,3 0,13	3,3 0,13	3	3	0,37	67,5	483448/418
	3,3 0,13	3,3 0,13	3	3	0,3	94	183448/410
760 29,921	3,3 0,13	3,3 0,13	3,1	3,1	0,37	67,5	483448/418

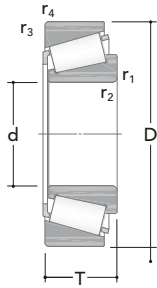

TS

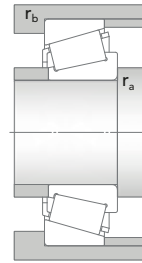

Main dimensions			Basic load ratings		Fatigue load limit C_u	Speed ratings		Designation Standard design
d	D	T	Dynamic C	Static C_0		Reference	Limiting	
[mm]/[in]			[kN]			[rpm]		
760	889	88,9	1876	5854	380,00	340	470	183448/410
29,921	35	3,5						
(cont.)								
762	889	69,85	1221	3786	256,00	370	480	483449/418
30,000	35	2,75						
	889	88,9	1876	5854	380,00	340	470	183449/410
	35	3,5						
774,7	965,2	93,662	1929	4938	332,00	310	430	752305/380
30,5	38	3,688						
801,688	914,4	58,738	1105	3529	237,00	330	460	584449/410
31,563	36	2,313						
838,2	1041,4	93,662	2026	5183	346,00	290	370	763330/410
33	41	3,688						
857,25	1092,2	120,65	2785	7325	477,00	280	370	157337/430
33,75	43	4,75						
928	1060	92	2209	8004	318,00	260	-	286948/910
36,535	41,732	3,622						
930	1060	92	2209	8004	318,00	260	-	286949/910
36,614	41,732	3,622						
977,9	1130,3	66,675	1434	4440	282,00	240	330	687949/910
38,5	44,5	2,625						
1016	1270	101,6	2734	7470	467,00	210	280	168400/500
40	50	4						

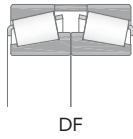
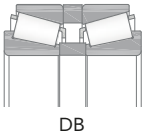

Dimensions					Factor	Mass	Designation
d	r _{1,2min}	r _{3,4min}	r _{amax}	r _{bmax}	e		Standard design
[mm]/[in]						[kg]	
760	3,3	3,3	3,1	3,1	0,3	94	183448/410
29,921	0,13	0,13					
(cont.)							
762	3,3	3,3	3	3	0,37	66,5	483449/418
30,000	0,13	0,13					
	3,3	3,3	3,1	3,1	0,3	94	183449/410
	0,13	0,13					
774,7	6,4	3,3	6	3	0,4	131	752305/380
30,5	0,25	0,13					
801,688	3,5	3,3	3	3	0,4	53,5	584449/410
31,563							
838,2	6,4	6,4	6	6	0,44	160	763330/410
33	0,25	0,25					
857,25	19	6,4	18	6	0,57	245	157337/430
33,75							
928	3,3	3,3	3	3	0,33	119	286948/910
36,535	0,13	0,13					
930	3,3	3,3	3	3	0,33	117	286949/910
36,614	0,13	0,13					
977,9	6,4	6,4	6	6	0,44	100	687949/910
38,5	0,25	0,25					
1016	9,7	9,7	9	9	0,5	275	168400/500
40							

Double row tapered roller bearings

RKB double row tapered roller bearings are produced in several configurations (TDO, TDONASW, TDI, TDIS) to support combined forces and locate the shaft in both directions. Manufactured with a given axial clearance (BEP), RKB double row tapered roller bearings can fully exploit their potential in a variety of industries and applications. In order to manufacture products with the highest possible resistance to fatigue and wear, RKB makes use of different bearing steel grades and special heat treatments. The bearing dimensional and running accuracy conforms to ISO/ABMA/GOST specifications.



Double row tapered roller bearings

Tolerances and accuracy

Dimensional and running tolerances for RKB double row tapered roller bearings are mostly in conformity with Normal class. Other specific tolerances may be available by customer request. For additional information please consult the RKB application engineering services.

Axial internal clearance

RKB double row tapered roller bearings TDO and TDI configuration feature a specific Bench End Play (BEP) according to application type, contact angle and main boundary dimension. Different value of B.E.P. maybe provided according to customer request. For additional information please consult the RKB application engineering services.

Misalignment

Angular misalignment lead to uneven load distribution among rollers and rows as well as local overloading. Thus reduction in terms of bearing life expectation may appear.

Minimum load

In order to get a correct functioning double row tapered roller bearings have to be always loaded with a minimum value, in particular in case of application featuring high speed, high acceleration and/or quick variation of load direction. According to the above condition the minimum required load can be evaluated as following:

$$\frac{F_m}{C} > 0,02$$

where:

- F_m minimum radial load, [kN];
- C dynamic load rating, [kN].

Designs and variants

Type TDO

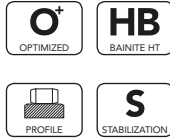
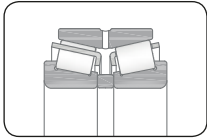

- One ribless outer ring (one double cup)
- Two inner rings with two ribs each (two single cones)
- Two one-piece window type pressed steel cages
- One single spacer between inner rings (plain or with lubrication grooves and holes)
- Supports radial and axial loads in both directions
- High arrangement stiffness
- Reduced angular misalignment
- Optimized roller profile
- Preset or adjusted BEP on customer's request
- Available in metric and inch sizes

Type TDI

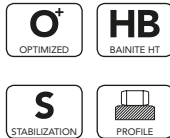
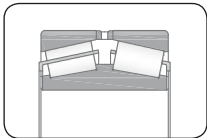

- Two ribless outer rings (two single cups)
- One inner ring with three ribs (one double cone)
- Two one-piece window type pressed steel cages
- One single spacer between outer rings (plain or with lubrication grooves and holes)
- Supports radial and axial loads in both directions
- Optimized roller profile
- Preset or adjusted BEP on customer's request
- Available in metric and inch sizes

Type TDONASW

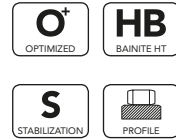
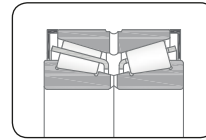

- One ribless outer ring (one double cup)
- Two inner rings with two ribs each (two single cones)
- Two one-piece window type pressed steel cages
- Lubrication grooves in cones internal side face
- Lateral shields or seals for contaminant exclusion
- Execution without spacer
- Supports radial and axial loads in both directions
- High arrangement stiffness
- Optimized roller profile
- Preset or adjusted BEP on customer's request
- Available in metric and inch sizes

Type TDIS with steep contact angle

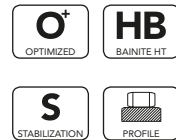
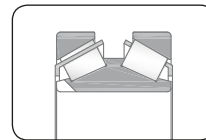

- Two ribless outer rings (two single cups)
- One inner ring with three ribs (one double cone)
- Two one-piece window type pressed steel cages
- Supports axial loads in both directions
- Designed with increased contact angle
- Suitable for high axial load carrying capacity
- Available with steel pin-type cage and pierced roller design
- Available with one or more antirotation keyway slots on each side of double cone
- Available in metric and inch sizes

Type TDISS with steep contact angle

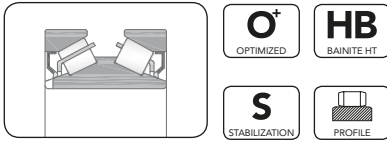

- Two ribless outer rings (two single cups)
- One inner ring with three ribs (one double cone)
- Two one-piece window type pressed steel cages
- Lateral seals for contaminant exclusion
- Supports axial loads in both directions
- Designed with increased contact angle
- Suitable for high axial load carrying capacity
- Available with steel pin-type cage and pierced roller design
- Available with one or more antirotation keyway slots on each side of double cone
- Available in metric and inch sizes

Type TDISS with retention sleeve

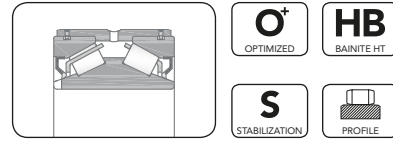

- Two ribless outer rings (two single cups)
- One inner ring with three ribs (one double cone)
- Two one-piece window type pressed steel cages
- Lateral seals for contaminant exclusion
- Preset or adjusted BEP on customer's request
- Designed with increased contact angle
- Suitable for high axial load carrying capacity
- Available with one or more antirotation keyway slots on each side of double cone
- Outer bush with annular groove and lubrication holes
- Available in metric and inch sizes

Type TDIS with retention sleeve

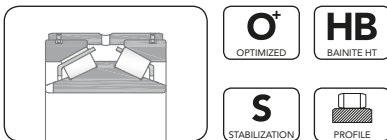

- Two ribless outer rings (two single cups)
- One inner ring with three ribs (one double cone)
- Two one-piece window type pressed steel cages
- Preset or adjusted BEP on customer's request
- Designed with increased contact angle
- Suitable for high axial load carrying capacity
- Available with one or more antirotation keyway slots on each side of double cone
- Outer bush with annular groove and lubrication holes
- Available in metric and inch sizes

Suffixes	Internal design
B	In TDI bearings, special double cone width. The number immediately following the B gives the double cone width in mm (decimals excluded)
C	In TDO bearings, special double cup width. The number immediately following the C gives the double cone width in mm (decimals excluded)
ZB	Optimized roller profile for improved load distribution. It is not necessarily stated in the bearing code
SP	Special or non-standard bearing
BT2B	Double row tapered roller bearing

Suffixes	Accuracy, clearance, running
HP	High precision (better than P6)

Suffixes	External design
FF/1	FKM seal on both sides
FF	NBR seal on both sides

Part numbering

First system

	Section 1	Section 2	Section 3	Section 4	Section 5
	Configuration	Boundary dimensions	Execution	Material and heat treatment of bearing components	Special surface treatment
	TDO, TDI, TDONA, TDIS, TDISS, TDIT, TDOS, TDONASW, TDONASWE, TDONASWB	dxDxT/DxTxd	A1...An, AA, AB, AD, AC1, A1B etc. indicating major or minor revision based on: customer's request, application requirement, technology or design advancement, presence of special features. The meaning of such combination of characters and numbers may vary from bearing to bearing	HB1...HB7 HA1...HA7	PT1...PT7 AWT1...AWT7 ACT1...ACT3
Example	TDO	020503/519395	AA3	HA4	PT4
	One double cup, two single cones, and two one-piece window type pressed steel cages, one cone single spacer between cones.	d: 02,95 inches = 74,93 mm D: 05,51 inches = 139,95 mm T: 03,93 inches = 99,82 mm	As basic TDO configuration, but with counterbored hole for locking pin and special Bench End Play	Cones, cup and rollers in case hardening steel	Phosphate treated cones, cup and rollers

Tab. 17 (1 of 2) - First system: structure

Section 6	Section 7	Section 8	Section 9	Section 10
Roller features	Final bearing specification	K	$r_{1,2 \text{ min}}$ $r_{3,4 \text{ min}}$	Suffix
ZB	BT2B	The three figures immediately following the K indicates the K thrust value without a decimal mark	The four figures immediately following the three digits of the K value indicate the minimum values in mm of radii 1,2 and 3,4 without decimal marks	Different features from standard version
ZB	BT2B	K136	3506	VL
Optimized roller profile for improved load distribution	Double row tapered roller bearing	K: 1,36	$r_{1,2 \text{ min}} : 3,5 \text{ mm}$ $r_{3,4 \text{ min}} : 0,6 \text{ mm}$	Victory Line

Tab. 17 (2 of 2) - First system: structure

Second system

	Section 1	Section 2	Section 3	Section 4
	Configuration	Boundary dimensions	Execution	Material and heat treatment of bearing components
	TDO, TDI, TDONA, TDIS, TDISS, TDIT, TDOS, TDONASW, TDONASWE, TDONASWB	Up to six digits	A1...An, AA, AB, AD, AE1, A1B etc. indicating major or minor revision based on: customer's request, application requirement, technology or design advancement, presence of special features. Typically the meaning of such combination of alphabetical and numerical characters vary from bearing to bearing.	HB1...HB7 HA1...HA7
Example	TDI	331792	A9	HB1
	Double row tapered roller bearing with one double cone, two one-piece window type pressed steel cages with rollers, two single cups, and one cup spacer. X configuration	No dimension indication	As basic TDI configuration, but with lubrication grooves in side faces of double cone	Cone and cups in through hardening steel with bainitic treatment

Tab. 18 (1 of 2) - Second system: structure

Section 5	Section 6	Section 7	Section 8
Configuration	Boundary dimensions	Execution	Material and heat treatment of bearing components
PT1...PT7 AWT1...AWT7 ACT1...ACT3	ZB	BT2B	Different features from standard version
ACT1	ZB	BT2B	VL
Anticorrosion treated cone and cups	Optimized roller profile for improved load distribution	Double row tapered roller bearing	Victory Line

Tab. 18 (2 of 2) - Second system: structure

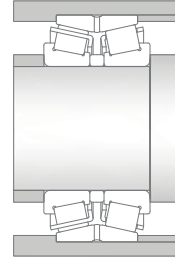
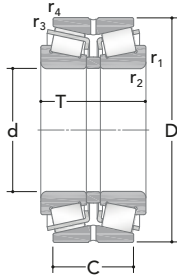

TDO

Main dimensions				Basic load ratings		Fatigue load limit C_u	Designation (AFBMA Part number)
d	D	T	C	Dynamic C	Static C_0		
[mm]				[kN]			
100	150	55	39,05	223	351	42	TDO 332759
3,937	5,906	2,165	1,537				
	150	76,2	61,976	301	534	61	TDO 328818
	5,906	3	2,44				
	180	80	64	458	638	72	TDO 617335
	7,087	3,150	2,520				
101,6	146,05	49,212	38,94	268	370	41	TDO 332767
4	5,75	1,938	1,533				(521945/910)
107,95	146,05	49,212	39,688	153	311	32,4	TDO 331392
4,25	5,75	1,938	1,563				(521949/910)
	146,05	49,212	39,688	153	311	32,4	TDO 331571
	5,75	1,938	1,563				(521949/910)
	158,75	53,978	39,688	127	321	37	TDO 614018
	6,25	2,125	1,563				(37425/626)
110	200	90	72	561	790	91	TDO 328947
4,331	7,874	3,543	2,835				
114,3	177,8	92,075	69,85	467	833	85	TDO 612700
4,5	7	3,625	2,75				(64450/700)
120	180	86	68	421	828	90	TDO 331181
4,724	7,087	3,386	2,677				
130	230	146	118,5	945	1690	171	TDO 330431
5,118	9,055	5,748	4,668				
133,35	215,9	106,362	80,962	643	1220	125	TDO 332160
5,25	8,5	4,188	3,188				(74525/851)

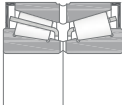

TDONASW

Dimensions			Factor	Mass	Designation
d	r _{1,2min}	r _{3,4min}	e		(AFBMA Part number)
[mm]				[kg]	
100	2,5	0,8	0,65	3,00	TDO 332759
3,937	3,5	0,6	0,40	4,25	TDO 328818
	3	0,8	0,43	7,65	TDO 617335
101,6	1,5	0,8	0,37	2,45	TDO 332767
4					(521945/910)
107,95	1,5	0,8	0,40	2,25	TDO 331392
4,25	1,5	0,8	0,40	2,25	(521949/910)
	3,5	0,8	0,60	3,00	TDO 331571
					(521949/910)
					TDO 614018
					(37425/626)
110	3	1	0,43	11,00	TDO 328947
4,331					
114,3	3,5	0,8	0,52	7,75	TDO 612700
4,5					(64450/700)
120	2,5	0,8	0,46	7,10	TDO 331181
4,724					
130	4	1,5	0,43	23,50	TDO 330431
5,118					
133,35	3,5	1,5	0,48	14,50	TDO 332160
5,25					(74525/851)

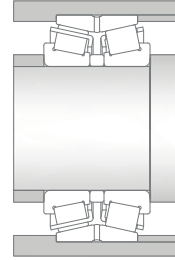
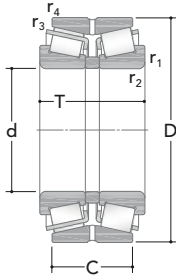

TDO

Main dimensions				Basic load ratings		Fatigue load limit	Designation
d	D	T	C	Dynamic C	Static C ₀	C _u	(AFBMA Part number)
[mm]				[kN]			
139,7	254	149,225	111,125	1086	1965	193	TDO 332750
5,5	10	5,875	4,375				(99550/102)
140	200	93,665	73,025	472	1042	102	TDO 442210
5,512	7,874	3,688	2,875				
146,05	193,675	65,085	53,975	316	689	72	TDO 331943
5,75	7,625	2,562	2,125				(36690/620)
150	225	107	78	683	1325	132	TDO 442211
5,906	8,858	4,213	3,071				
152,4	222,25	100,01	76,2	612	1268	123	TDO 613328
6	8,75	3,937	3				(231649/610)
155	200	66	54	311	613	61	TDO 328957
6,102	7,874	2,598	2,126				
160	240	114	84	785	1544	158	TDO 442212
6,299	9,449	4,488	3,307				
	270	150	120	1200	2279	220	TDO 332758
	10,630	5,906	4,724				
165,1	225,425	85,725	69,85	491	1167	113	TDO 331792
6,5	8,875	3,375	2,75				(46790/720)
	288,925	142,875	111,125	1183	2260	218	TDO 328697
	11,375	5,625	4,375				(94649/114)
177,8	269,875	119,062	93,662	871	1872	186	TDO 332585
7	10,625	4,688	3,688				(238840/810)
180	270	109,538	84,138	676	1621	144	TDO 442213
7,087	10,630	4,313	3,313				

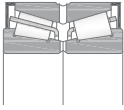

TDONASW

Dimensions			Factor	Mass	Designation
d	r _{1,2min}	r _{3,4min}	e		(AFBMA Part number)
[mm]				[kg]	
139,7 5,5	7	1,5	0,40	31,00	TDO 332750 (99550/102)
140 5,512	5	1	0,33	9,30	TDO 442210
146,05 5,75	1,5	0,8	0,37	5,00	TDO 331943 (36690/620)
150 5,906	5	1	0,46	14,50	TDO 442211
152,4 6	3,5	0,8	0,33	12,00	TDO 613328 (231649/610)
155 6,102	1,5	0,6	0,35	4,85	TDO 328957
160 6,299	5	1	0,46	16,50	TDO 442212
	4	1	0,40	32,50	TDO 332758
165,1 6,5	8	0,8	0,37	10,00	TDO 331792 (46790/720)
	7	1,5	0,46	38,00	TDO 328697 (94649/114)
177,8 7	3,5	1,5	0,33	23,00	TDO 332585 (238840/810)
180 7,087	5	1	0,48	22,50	TDO 442213

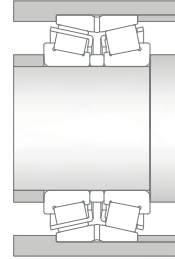
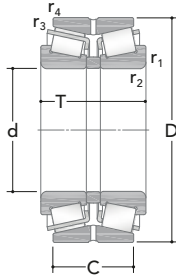

TDO

Main dimensions				Basic load ratings		Fatigue	Designation
d	D	T	C	Dynamic C	Static C ₀	load limit C _u	(AFBMA Part number)
[mm]				[kN]			
187,325	269,875	119,062	93,662	890	1896	183	TDO 328698
7,375	10,625	4,688	3,688				(238849/810)
200	290	121	88	1364	2724	257	TDO 442214
7,874	11,417	4,764	3,465				
200,025	317,5	146,05	111,125	1181	2387	221	TDO 332459
7,875	12,5	5,75	4,375				(93787/127)
203,2	317,5	120,65	88,9	1011	1978	188	TDO 331785
8	12,5	4,764	3,5				(132083/126)
206,375	336,55	211,138	169,862	2098	4303	380	TDO 328270
8,125	13,25	8,313	6,688				(242649/610)
220	340	164	130	1645	3366	299	TDO 332473
8,661	13,386	6,457	5,118				
	370	120	107	1305	2272	209	TDO 328794
	14,567	4,724	4,213				
228,6	327,025	114,3	82,55	830	2106	191	TDO 332584
9	12,875	4,5	3,25				(8573/8520)
	358,775	152,4	117,475	1531	3525	312	TDO 332766
	14,125	6	4,628				(249732/710)
	488,95	254	152,4	3108	4554	385	TDO 331945
	19,25	10	6				(949549/510)
241,3	368,3	120,65	85,725	995	2053	185	TDO 331783
9,5	14,5	4,75	3,375				(170950/451)
247,65	406,4	247,65	203,2	2985	6257	514	TDO 332443
9,75	16	9,75	8				(249949/910)

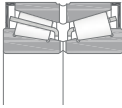

TDONASW

Dimensions			Factor	Mass	Designation
d	r _{1,2min}	r _{3,4min}	e		(AFBMA Part number)
[mm]				[kg]	
187,325 7,375	3,5	1,5	0,33	21,00	TDO 328698 (238849/810)
200 7,874	5	1	0,43	24,00	TDO 442214
200,025 7,875	4,3	1,5	0,52	41,50	TDO 332459 (93787/127)
203,2 8	6,4	1,5	0,31	34,00	TDO 331785 (132083/126)
206,375 8,125	3,3	1,5	0,33	70,00	TDO 328270 (242649/610)
220 8,661	4	1	0,43	50,00	TDO 332473
	5	1,5	0,40	49,00	TDO 328794
228,6 9	6,4	1,5	0,40	30,00	TDO 332584 (8573/8520)
	3,5	1,5	0,33	57,00	TDO 332766 (249732/710)
	6,4	1,5	0,94	205,00	TDO 331945 (949549/510)
241,3 9,5	6,4	1,5	0,37	39,50	TDO 331783 (170950/451)
247,65 9,75	6,4	1,5	0,33	120,00	TDO 332443 (249949/910)

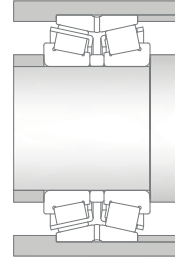
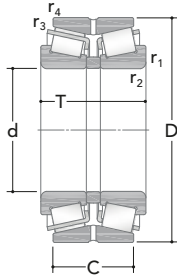

TDO

Main dimensions				Basic load ratings		Fatigue load limit C_u	Designation (AFBMA Part number)
d	D	T	C	Dynamic C	Static C_0		
[mm]				[kN]			
254	422,275	173,038	128,66	2420	4039	356	TDO 328615
10	16,625	6,813	5,065				
	422,275	178,592	139,7	2420	4039	356	TDO 331782 (252343/310)
	16,625	7,031	5,5				
	533,4	276,225	165,1	3424	5534	452	TDO 331781 (953749/710)
	21	10,875	6,5				
260	360	105	76	979	1988	181	TDO 328027
	14,173	4,134	2,992				
	400	104	92	1108	2091	185	TDO 328795
	15,748	4,095	3,622				
	440	144	128	1994	3481	302	TDO 617479
	17,323	5,669	9,039				
	480	284	220	4320	7278	606	TDO 328130
	18,898	11,181	8,661				
260,35	422,275	178,592	139,7	2226	4038	356	TDO 328187 (252349/310)
10,25	16,625	7,031	5,5				
280	470	250	180	3460	6399	530	TDO 331717
11,024	18,504	9,843	7,087				
285,75	380,898	139,7	107,95	1221	3212	269	TDO 332449 (654648/610)
11,25	14,996	5,5	4,25				
288,925	406,4	165,1	130,175	1960	4562	375	TDO 332503 (255449/410)
11,375	16	6,5	5,125				
300	500	203	152	3013	5084	426	TDO 328383
11,811	19,685	7,992	5,984				
300,038	422,275	174,625	136,525	2173	4745	400	TDO 332504 (256849/810)
11,813	16,625	6,875	5,375				

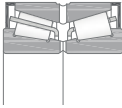

TDONASW

Dimensions			Factor	Mass	Designation
d	r _{1,2min}	r _{3,4min}	e		(AFBMA Part number)
[mm]				[kg]	
254	6,8	1,5	0,33	87,50	TDO 328615
10	6,8	1,5	0,33	97,50	TDO 331782 (252343/310)
	6,4	1,5	0,94	260,00	TDO 331781 (953749/710)
260	3	1	0,35	28,00	TDO 328027
	5	1,5	0,40	44,00	TDO 328795
	5	1,5	0,37	86,50	TDO 617479
	5	1,5	0,43	210,00	TDO 328130
260,35	6,8	1,5	0,33	86,50	TDO 328187 (252349/310)
10,25					
280	6,4	1,5	0,46	155,00	TDO 331717
11,024					
285,75	3,5	1,5	0,43	42,00	TDO 332449 (654648/610)
11,25					
288,925	6,4	1,5	0,33	63,00	TDO 332503 (255449/410)
11,375					
300	5	1,5	0,40	140,00	TDO 328383
11,811					
300,038	6,4	1,5	0,33	71,50	TDO 332504 (256849/810)
11,813					

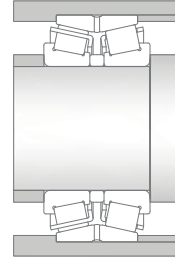
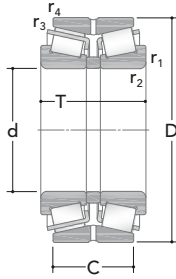

TDO

Main dimensions				Basic load ratings		Fatigue load limit	Designation
d	D	T	C	Dynamic C	Static C ₀	C _u	(AFBMA Part number)
[mm]				[kN]			
317,5	447,675	180,975	146,05	2519	5370	442	TDO 615058
12,5	17,625	7,125	5,75				(259049/010)
	447,675	180,975	146,05	2519	5370	442	TDO 332516
	17,625	7,125	5,75				(259049/010)
330,2	482,6	177,8	127	2150	5046	411	TDO 332845
13	19	7	5				(526132/191)
333,375	469,9	190,5	152,4	2641	5784	458	TDO 331775
13,125	18,5	7,5	6				(261049/100)
340	460	160	128	2168	4953	396	TDO 332830
13,386	18,110	6,299	5,039				
342,9	533,4	174,625	123,825	2539	4368	368	TDO 332802
13,5	21	6,875	4,875				(971354/103)
346,075	488,95	200,025	158,75	2799	6281	512	TDO 331981
13,625	19,25	7,875	6,25				(262749/710)
355,6	444,5	136,525	111,125	1347	3620	302	TDO 332505
14	17,5	5,375	4,375				(163149/110)
	501,65	155,575	107,95	1964	4202	349	TDO 332506
	19,75	6,125	4,25				(231400/976)
360	480	160	128	2212	4936	410	TDO 332831
14,173	18,898	6,299	5,039				
368,249	523,875	214,312	169,862	3389	7490	586	TDO 332603
14,498	20,625	8,438	6,688				(265049/010)
368,3	596,9	203,2	133,35	3232	5905	461	TDO 332754
14,5	23,5	8	5,25				(181453/351)

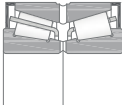

TDONASW

Dimensions			Factor	Mass	Designation
d	r _{1,2min}	r _{3,4min}	e		(AFBMA Part number)
[mm]				[kg]	
317,5	3,5	1,5	0,33	84,00	TDO 615058
12,5	3,5	1,5	0,33	84,00	(259049/010) TDO 332516 (259049/010)
330,2	3,3	1,5	0,40	100,00	TDO 332845
13					(526132/191)
333,375	6,4	1,5	0,33	98,00	TDO 331775
13,125					(261049/100)
340	3	1	0,31	71,00	TDO 332830
13,386					
342,9	4,8	1,5	0,33	130,00	TDO 332802
13,5					(971354/103)
346,075	6,4	1,5	0,33	110,00	TDO 331981
13,625					(262749/710)
355,6	3,5	1,5	0,31	46,00	TDO 332505
14	6,4	1,5	0,44	87,00	(163149/110) TDO 332506 (231400/976)
360	3	1	0,33	73,00	TDO 332831
14,173					
368,249	6,4	1,5	0,33	140,00	TDO 332603
14,498					(265049/010)
368,3	9,7	2,3	0,40	188,00	TDO 332754
14,5					(181453/351)

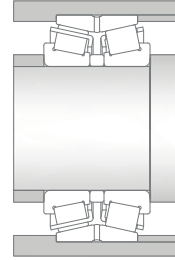
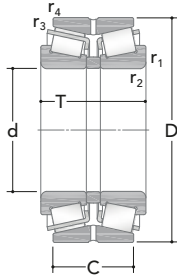

TDO

Main dimensions				Basic load ratings		Fatigue load limit	Designation
d	D	T	C	Dynamic C	Static C ₀	C _u	(AFBMA Part number)
[mm]				[kN]			
371,475	501,65	155,575	107,95	1967	4302	341	TDO 331606
14,625	19,75	6,125	4,25				(231462/976)
380	520	148	112	2287	4453	369	TDO 328020
14,961	20,472	5,827	4,410				
	660	380	310	7631	15863	1130	TDO 332823
	25,984	14,961	12,205				(267648/610)
381	508	139,7	88,9	1360	3232	272	TDO 332507
15	20	5,5	3,5				(192150/201)
384,175	546,1	222,25	177,8	3703	8207	647	TDO 331197
15,125	21,5	8,75	7				(266449/410)
406,4	539,75	142,875	101,6	1832	4349	349	TDO 328389
15	21,25	5,625	4				(234160/213)
415,925	590,55	244,475	193,675	4164	9561	727	TDO 331656
16,375	23,25	9,625	7,625				(268749/710)
431,8	571,5	155,575	111,125	1920	5045	409	TDO 332604
17	22,5	6,125	4,375				(869449/410)
	571,5	192,088	146,05	2804	6985	527	TDO 332237
	22,5	7,563	5,75				(769349/310)
440	650	196	157	3723	7722	580	TDO 328796
17,323	25,591	7,717	6,181				
447,675	635	257,175	206,375	4444	11092	793	TDO 332176
17,625	25	10,125	8,125				(270749/710)
457,2	596,9	165,1	120,65	2139	5513	414	TDO 328980
18	23,5	6,5	4,75				(244180/236)

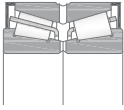

TDONASW

Dimensions			Factor	Mass	Designation
d	r _{1,2min}	r _{3,4min}	e		(AFBMA Part number)
[mm]				[kg]	
371,475 14,625	6,4	1,5	0,44	76,50	TDO 331606 (231462/976)
380 14,961	4	1,5	0,30	80,20	TDO 328020
	14	3,5	0,33	520,00	TDO 332823 (267648/610)
381 15	6,4	1,5	0,54	67,00	TDO 332507 (192150/201)
384,175 15,125	6,4	1,6	0,33	161,00	TDO 331197 (266449/410)
406,4 15	6,4	1,5	0,48	82,40	TDO 328389 (234160/213)
415,925 16,375	6,4	1,5	0,33	205,00	TDO 331656 (268749/710)
431,8 17	3,3	1,5	0,54	100,00	TDO 332604 (869449/410)
	6,4	1,5	0,44	125,00	TDO 332237 (769349/310)
440 17,323	6	3	0,37	203,00	TDO 328796
447,675 17,625	6,4	1,5	0,33	245,00	TDO 332176 (270749/710)
457,2 18	9,7	1,5	0,40	110,00	TDO 328980 (244180/236)

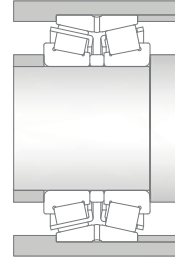
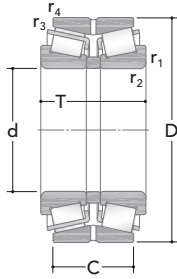

TDO

Main dimensions				Basic load ratings		Fatigue load limit	Designation
d	D	T	C	Dynamic C	Static C ₀	C _u	(AFBMA Part number)
[mm]				[kN]			
479,425	679,45	276,225	222,25	4978	12574	924	TDO 331657
18,875	26,75	10,875	8,75				(272749/710)
489,026	634,873	177,8	142,875	2787	7434	534	TDO 331776
19,253	24,995	7	5,625				(243192/251)
498,475	634,873	177,8	142,875	2774	7320	542	TDO 331605
19,625	24,995	7	5,625				(243196/251)
	634,873	177,8	142,875	2774	7320	542	TDO 331605
	24,995	7	5,625				(243196/251)
501,65	711,2	292,1	231,775	5547	13874	968	TDO 332605
19,75	28	11,5	9,125				(274149/110)
508	838,2	304,8	222,25	6383	13852	1011	TDO 614995
20	33	12	8,75				(426200/331)
520,7	736,6	186,502	114,3	3018	6783	494	TDO 332761
20,5	29	7,343	4,5				(982051/901)
536,575	761,873	311,15	247,65	6360	15991	1101	TDO 332446
21,125	29,995	12,25	9,75				(276449/410)
558,8	736,6	187,328	138,112	3425	8401	613	TDO 331790
22	29	7,375	5,438				(843220/291)
	736,6	225,425	177,8	4230	11380	1	TDO 331640
	29	8,875	7				(377449/410)
571,5	812,8	333,375	263,525	6392	16057	1076	TDO 332447
22,5	32	13,125	10,375				(278749/710)
602,945	787,4	206,375	158,75	4008	10748	740	TDO 331576
23,738	31	8,125	6,25				

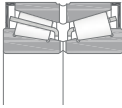

TDONASW

Dimensions			Factor	Mass	Designation
d	r _{1,2min}	r _{3,4min}	e		(AFBMA Part number)
[mm]				[kg]	
479,425 18,875	6,4	1,5	0,33	302,00	TDO 331657 (272749/710)
489,026 19,253	6,4	1,5	0,35	130,00	TDO 331776 (243192/251)
498,475 19,625	6,4	1,5	0,35	125,00	TDO 331605 (243196/251)
	6,4	1,5	0,35	125,00	TDO 331605 (243196/251)
501,65 19,75	6,4	1,5	0,33	343,00	TDO 332605 (274149/110)
508 20	9,7	3,3	0,48	630,00	TDO 614995 (426200/331)
520,7 20,5	6,4	1,5	0,48	210,00	TDO 332761 (982051/901)
536,575 21,125	6,4	1,5	0,33	430,00	TDO 332446 (276449/410)
558,8 22	6,4	1,5	0,35	190,00	TDO 331790 (843220/291)
	6,4	1,5	0,35	150,00	TDO 331640 (377449/410)
571,5 22,5	6,4	1,5	0,33	520,00	TDO 332447 (278749/710)
602,945 23,738	6,4	1,5	0,37	180,00	TDO 331576

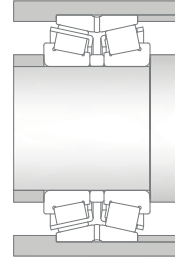
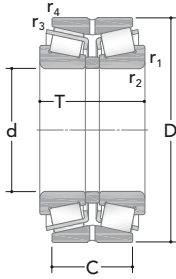

TDO

Main dimensions				Basic load ratings		Fatigue load limit	Designation
d	D	T	C	Dynamic C	Static C ₀	C _u	(AFBMA Part number)
[mm]				[kN]			
609,6	812,8	190,5	146,05	3594	8806	640	TDO 614609
24	32	7,5	5,75				(649240/311)
	787,4	206,375	158,75	3978	10707	743	TDO 332448
	31	8,125	6,25				
	820	206,375	158,75	4031	10749	740	TDO 331500
	32,284	8,125	6,25				
635	990,6	339,725	212,725	8074	16178	1048	TDO 332493
25	39	13,375	8,375				
685,8	876,3	200,025	152,4	3860	10869	759	TDO 331290
27	34,5	7,875	6				
711,2	914,4	190,5	139,7	3809	9675	668	TDO 328028
28	36	7,5	5,5				(755280/361)
723,9	914,4	187,325	139,7	3781	9704	666	TDO 331554
28,5	36	7,375	5,5				(755285/361)
762	965,2	187,325	133,35	3624	9698	677	TDO 331780
30	38	7,375	5,25				(752300/381)
774,7	965,2	187,325	133,35	3587	9683	678	TDO 332764
30,5	38	7,375	5,25				(752305/381)
774,962	1016	266,7	209,55	6369	16963	1102	TDO 332625
30,510	40	10,5	8,25				
812,8	1016	190,5	146,05	3595	10232	678	TDO 331291
32	40	7,5	5,75				(762320/401)
	1066,8	190,5	146,05	3562	10269	675	TDO 328371
	42	7,5	5,75				(762320/420)

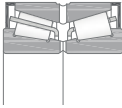

TDONASW

Dimensions			Factor	Mass	Designation
d	r _{1,2min}	r _{3,4min}	e		(AFBMA Part number)
[mm]				[kg]	
609,6	6,4	3,3	0,33	250,00	TDO 614609
24	6,4	1,5	0,37	232,00	(649240/311) TDO 332448
	6,4	1,5	0,37	292,00	TDO 331500
635	6,4	6,4	0,88	840,00	TDO 332493
25					
685,8	6,4	1,5	0,43	270,00	TDO 331290
27					
711,2	6,4	1,5	0,37	265,00	TDO 328028
28					(755280/361)
723,9	3,3	1,5	0,37	250,00	TDO 331554
28,5					(755285/361)
762	6,4	1,5	0,40	290,00	TDO 331780
30					(752300/381)
774,7	6,4	1,5	0,40	265,00	TDO 332764
30,5					(752305/381)
774,962	8	2,5	0,33	525,00	TDO 332625
30,510					
812,8	6,4	1,5	0,43	350,00	TDO 331291
32					(762320/401)
	6,4	1,5	0,43	445,00	TDO 328371
					(762320/420)

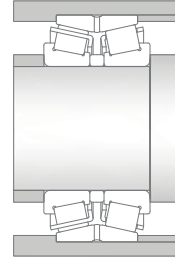
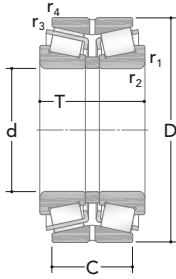

TDO

Main dimensions				Basic load ratings		Fatigue load limit	Designation
d	D	T	C	Dynamic C	Static C ₀	C _u	(AFBMA Part number)
[mm]				[kN]			
863,6	1371,6	469,9	285,75	14547	31596	1955	TDO 332494
34	54	18,5	11,25				
914,4	1066,8	139,7	101,6	2601	8093	514	TDO 332501
36	42	5,5	4				(686947/910)
	1066,8	139,7	101,6	2601	8093	514	TDO 332501
	42	5,5	4				(686947/910)
939,8	1270	457,2	317,5	9535	29316	1682	TDO 328304
37	50	18	12,5				
1120	1480	400	296	13474	38400	2098	TDO 332756
44,095	58,268	15,748	11,654				
1160	1540	400	290	14183	38377	2178	TDO 332780
45,669	60,630	15,748	11,417				
1250	1500	250	190	7371	22701	1302	TDO 328339
49,213	59,055	9,843	7,480				
1320,8	1727,2	412,75	254	13999	41102	2207	TDO 332495
52	68	16,25	10				
1562,1	1806,575	279,4	196,85	7301	27789	1511	TDO 328310
61,5	71,125	11	7,75				(299615/711)
1778	2159	393,7	266,7	15581	53650	2667	TDO 332496
70	5	15,5	10,5				
2133,6	2819,4	742	457,2	34928	107119	5041	TDO 332497
84	111	29,213	18				

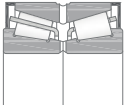

TDONASW

Dimensions			Factor	Mass	Designation
d	r _{1,2min}	r _{3,4min}	e		(AFBMA Part number)
[mm]				[kg]	
863,6 34	28	2	0,88	2250,00	TDO 332494
914,4 36	6,4	3,3	0,40	190,00	TDO 332501 (686947/910)
	6,4	3,3	0,40	190,00	TDO 332501 (686947/910)
939,8 37	12,7	3,3	0,88	1540,00	TDO 328304
1120 44,095	12	4	0,44	1760,00	TDO 332756
1160 45,669	12	4	0,44	1900,00	TDO 332780
1250 49,213	6	1,5	0,35	795,00	TDO 328339
1320,8 52	28	2	0,83	2325,00	TDO 332495
1562,1 61,5	9,7	3,3	0,48	1045,00	TDO 328310 (299615/711)
1778 70	12,7	3	0,79	2750,00	TDO 332496
2133,6 84	15x45°	3,5	0,94	11600,00	TDO 332497

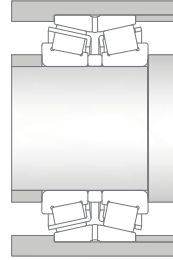
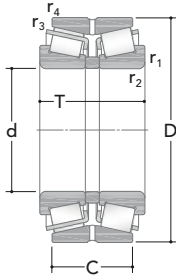

TDO

Main dimensions				Basic load ratings		Fatigue load limit C_u	Designation (AFBMA Part number)
d	D	T	C	Dynamic C	Static C_0		
[mm]				[kN]			
2184,4	2527,3	304,8	165,1	9351	37682	1891	TDO 332673
86	99,5	12	6,5				
2616,2	3048	381	209,55	12265	52386	2479	8020
103	120	15	8,25				
3378,2	3835,4	393,7	203,2	15279	63065	2797	8019
133	151	15,5	8				
3811	4216,4	419,1	274,7	19519	108618	4375	TDO 334004
150	166	16,5	10,815				

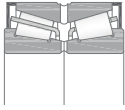

TDONASW

Dimensions			Factor	Mass	Designation
d	r _{1,2min}	r _{3,4min}	e		(AFBMA Part number)
[mm]				[kg]	
2184,4 86	16	5	1,15	2230,00	TDO 332673
2616,2 103	25,4	6,4	1,50	4485,00	8020
3378,2 133	25,4	6,4	1,50	6380,00	8019
3811 150	9,7	6,4	1,05	6315,00	TDO 334004

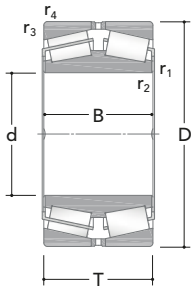

TDI

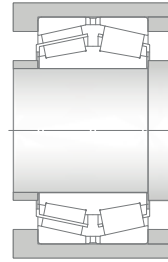

Main dimensions				Basic load ratings		Fatigue	Designation (AFBMA Part number)
d	D	T	B	Dynamic C	Static C ₀	load limit C _u	
[mm]				[kN]			
152,4	222,25	84,138	84,138	610	1254	125	TDI 331387
6	8,75	3,313	3,313				(231649/610)
177,8	247,65	90,488	90,488	669	1522	138	TDI 331814
7	9,75	3,563	3,563				(67790/720)
	288,925	123,825	123,825	1299	2262	218	TDI 332534
	11,375	4,875	4,875				(237546/510)
203,2	317,5	133,35	133,35	1170	2408	219	TDI 332799
8	12,5	5,25	5,25				(93801D/125)
	368,3	158,75	152,4	1977	3397	301	TDI 332683
	14,5	6,25	6				(420800/450)
206,375	282,575	87,312	87,312	696	1661	153	TDI 331388
8,125	11,125	3,438	3,438				(67985/920)
	336,55	180,975	184,15	2124	4273	382	TDI 328834
	13,25	7,125	7,25				(242649/610)
220	340	140	200	1660	3362	299	TDI 332873
8,661	13,386	5,512	7,874				
234,95	327,025	93,662	93,662	843	2150	187	TDI 332492
9,25	12,875	3,688	3,688				(8576/8500)
240	480	220	200	3637	5501	465	TDI 332931
9,449	18,898	8,681	7,874				
254	358,775	130,175	130,175	1545	3578	308	TDI 332296
10	14,125	5,125	5,125				(249749/710)
	438,15	165,1	165,1	2679	4252	365	TDI 332536
	17,25	6,5	6,5				(738101/172)
269,875	381	136,525	136,525	1630	3753	325	TDI 331223
10,625	15	5,375	5,375				(252349/310)

Dimensions			Factor	Mass	Designation
d	r _{1,2min}	r _{3,4min}	e		(AFBMA Part number)
[mm]				[kg]	
152,4 6	1,5	1,5	0,33	11,50	TDI 331387 (231649/610)
177,8 7	1,5	3,3	0,44	13,00	TDI 331814 (67790/720)
	1,5	3,3	0,31	31,50	TDI 332534 (237546/510)
203,2 8	6,4	3,3	0,52	40,00	TDI 332799 (93801D/125)
	3,3	3,3	0,40	75,00	TDI 332683 (420800/450)
206,375 8,125	0,8	3,3	0,50	17,00	TDI 331388 (67985/920)
	1,5	3,3	0,33	66,50	TDI 328834 (242649/610)
220 8,661	1,5	3	0,43	50,50	TDI 332873
234,95 9,25	1,5	3,3	0,40	25,50	TDI 332492 (8576/8500)
240 9,449	2,5	5	0,72	183,00	TDI 332931
254 10	1,5	3,3	0,33	43,50	TDI 332296 (249749/710)
	3,3	6,4	0,35	100,00	TDI 332536 (738101/172)
269,875 10,625	3,3	3,3	0,33	51,00	TDI 331223 (252349/310)

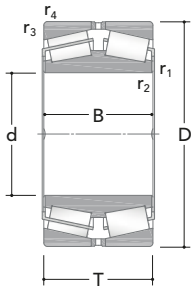

TDI

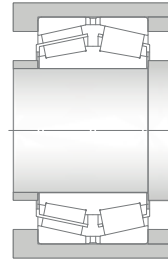

Main dimensions				Basic load ratings		Fatigue	Designation (AFBMA Part number)
d	D	T	B	Dynamic C	Static C ₀	load limit C _u	
[mm]				[kN]			
279,587	380,898	117,475	117,475	1227	3208	269	TDI 332899
11,007	14,996	4,625	4,625				(654644/610)
288,925	406,4	165,1	234,95	2257	4851	419	TDI 332870
11,375	16	6,5	9,25				
300,038	422,275	150,812	150,812	2180	4686	405	TDI 331951
11,813	16,625	5,938	5,938				(256849/810)
303,212	495,3	263,525	263,525	4904	9720	756	TDI 332685
11,938	19,5	10,375	10,375				(258249/210)
317,5	422,275	128,588	128,588	1777	4093	350	TDI 328699
12,5	16,625	5,063	5,063				(528648/610)
333,375	469,9	166,688	166,688	2653	5750	461	TDI 328695
13,125	18,5	6,563	6,563				(261049/010)
	469,9	166,688	231,775	2653	5750	461	TDI 332871
	18,5	6,563	9,125				
342,9	533,4	139,7	146,05	2300	4363	368	TDI 331713
13,5	21	5,5	5,75				(971355/100)
343,052	457,098	122,238	122,238	1604	3419	278	TDI 332240
13,506	17,996	4,813	4,813				(76164/600)
346,075	488,95	104,775	95,25	1140	2770	226	TDI 332913
13,625	19,25	4,125	3,75				(161362/925)
	488,95	174,625	174,625	2839	6239	515	TDI 331527
	19,25	6,875	6,875				(262749/710)
	488,95	174,625	174,625	2802	6233	515	TDI 328410
	19,25	6,875	6,875				(262749/710)

Dimensions			Factor	Mass	Designation
d	r _{1,2min}	r _{3,4min}	e		(AFBMA Part number)
[mm]				[kg]	
279,587 11,007	1,5	3,3	0,43	41,50	TDI 332899 (654644/610)
288,925 11,375	1,6	3,2	0,33	73,00	TDI 332870
300,038 11,813	3,3	3,3	0,33	70,00	TDI 331951 (256849/810)
303,212 11,938	3,3	6,4	0,33	212,00	TDI 332685 (258249/210)
317,5 12,5	1,5	3,3	0,31	51,50	TDI 328699 (528648/610)
333,375 13,125	3,3	3,3	0,33	92,50	TDI 328695 (261049/010)
	1,6	3,3	0,33	98,00	TDI 332871
342,9 13,5	3,3	3,3	0,33	115,00	TDI 331713 (971355/100)
343,052 13,506	1,5	3,3	0,48	54,00	TDI 332240 (76164/600)
346,075 13,625	1,5	6,4	0,50	62,00	TDI 332913 (161362/925)
	3,3	3,3	0,33	110,00	TDI 331527 (262749/710)
	3,3	3,3	0,33	113,00	TDI 328410 (262749/710)

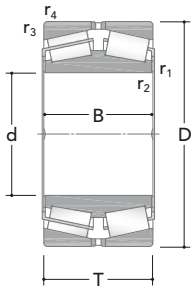

TDI

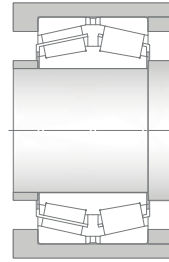

Main dimensions				Basic load ratings		Fatigue	Designation
d	D	T	B	Dynamic C	Static C ₀	load limit C _u	(AFBMA Part number)
[mm]				[kN]			
360	680	330	300	7268	13587	967	TDI 331729
14,173	26,772	12,992	11,811				
368,3	523,875	185,738	185,738	3369	7523	583	TDI 331836
14,5	20,625	7,313	7,313				(265049/010)
	523,875	185,738	185,738	3369	7523	583	TDI 332468
	20,625	7,313	7,313				(265049/010)
	596,9	165,1	158,75	3066	5888	462	TDI 331905
	23,5	6,5	6,25				
384,175	546,1	193,675	193,675	3737	8357	636	TDI 331158
15,125	21,5	7,625	7,625				(266449/410)
	546,1	193,675	193,675	3737	8357	636	TDI 328580
	215000	7,625	7,625				(266449/410)
	546,1	193,675	193,675	3737	8357	636	TDI 331837
	21,5	7,625	7,625				(266449/410)
390	546,1	141,288	141,288	2353	5164	400	TDI 328705
15,354	21,5	5,563	5,563				
406,4	546,1	138,113	138,113	2355	5155	401	TDI 331840
16	21,5	5,438	5,438				(767749/710)
408,4	546,1	120	98	1587	3404	289	TDI 328874
16,079	21,5	4,724	3,858				
	546,1	150	125	1986	4746	375	TDI 328466
	21,5	5,906	4,921				
409,575	546,1	161,925	161,925	2692	6459	507	TDI 331714
16,125	21,5	6,375	6,375				(667947/910)
415,925	590,55	209,55	209,55	4161	9719	715	TDI 328283
16,375	23,25	8,25	8,25				(268749/710)

Dimensions			Factor	Mass	Designation
d	r _{1,2min}	r _{3,4min}	e		(AFBMA Part number)
[mm]				[kg]	
360 14,173	4	7,5	0,60	540,00	TDI 331729
368,3 14,5	3,3	6,4	0,33	133,00	TDI 331836 (265049/010)
	3,3	6,4	0,33	140,00	TDI 332468 (265049/010)
	6,4	6,4	0,40	160,00	TDI 331905
384,175 15,125	3,3	6,4	0,33	152,00	TDI 331158 (266449/410)
	3,3	6,4	0,33	166,00	TDI 328580 (266449/410)
	3,3	6,4	0,33	152,00	TDI 331837 (266449/410)
390 15,354	3,3	6,4	0,48	102,00	TDI 328705
406,4 16	1,5	6,4	0,48	89,00	TDI 331840 (767749/710)
408,4 16,079	1	3	0,88	76,50	TDI 328874
	1,5	3,3	0,83	99,00	TDI 328466
409,575 16,125	1,5	6,4	0,43	110,00	TDI 331714 (667947/910)
415,925 16,375	3,3	6,4	0,33	192,00	TDI 328283 (268749/710)

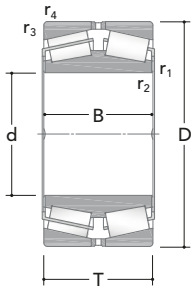

TDI

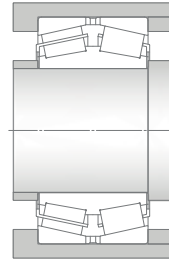

Main dimensions				Basic load ratings		Fatigue	Designation (AFBMA Part number)
d	D	T	B	Dynamic C	Static C ₀	load limit C _u	
[mm]				[kN]			
415,925	590,55	209,55	209,55	4161	9719	715	TDI 331445
16,375	23,25	8,25	8,25				(268749/710)
(cont.)							
430	535	84	84	1072	3044	237	TDI 334013
16,929	21,063	3,307	3,307				
447,675	635	223,838	223,838	4424	11052	796	TDI 331562
17,625	25	8,813	8,813				(270749/710)
	635	223,838	223,838	4424	11052	796	TDI 332911
	25	8,813	8,813				(270749/710)
450	595	178	178	3157	8065	616	TDI 328523
17,717	23,425	70,008	70,008				(270449/410)
464	615,95	150	136	2134	5901	436	TDI 328361
18,268	24,25	5,906	5,354				
489,026	634,873	152,4	152,4	2747	7405	536	TDI 331848
19,253	24,995	6	6				(243193/250)
491	635	148	128	1912	5293	406	TDI 328381
19,331	25	5,827	5,039				
500	730	280	280	6681	15810	1085	TDI 331676
19,685	28,740	11,024	11,024				
501,65	673,1	184,15	184,15	3961	9665	719	TDI 332547
19,75	26,5	7,25	7,25				
	711,2	250,825	250,825	5575	13827	956	TDI 331182
	28	9,875	9,875				(274149/110)
519,112	736,6	258,762	258,762	6048	15591	1069	TDI 332662
20,438	29	10,188	10,188				(275349/310)

Dimensions			Factor	Mass	Designation
d	r _{1,2min}	r _{3,4min}	e		(AFBMA Part number)
[mm]				[kg]	
415,925 16,375	3,3	6,4	0,33	192,00	TDI 331445 (268749/710)
(cont.)					
430 16,929	1	3	0,54	44,50	TDI 334013
447,675 17,625	3,3	6,4	0,33	236,00	TDI 331562 (270749/710)
	3,3	6,4	0,33	246,00	TDI 332911 (270749/710)
450 17,717	3	6	0,33	140,00	TDI 328523 (270449/410)
464 18,268	1,5	4	0,83	125,00	TDI 328361
489,026 19,253	3,3	3,3	0,35	130,00	TDI 331848 (243193/250)
491 19,331	1,5	3,3	1,00	120,00	TDI 328381
500 19,685	3	6	0,31	420,00	TDI 331676
501,65 19,75	3,3	6,4	0,31	190,00	TDI 332547
	3,2	6,4	0,33	330,00	TDI 331182 (274149/110)
519,112 20,438	3,3	6,4	0,33	370,00	TDI 332662 (275349/310)

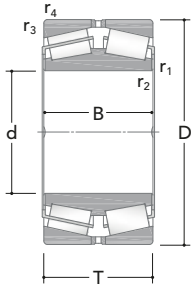

TDI

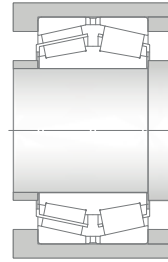

Main dimensions				Basic load ratings		Fatigue	Designation (AFBMA Part number)
d	D	T	B	Dynamic C	Static C ₀	load limit C _u	
[mm]				[kN]			
519,112	736,6	258,762	258,762	6048	15591	1069	TDI 334009
20,438	29	10,188	10,188				(275349/310)
(cont.)							
522	690	180	160	2846	8273	602	TDI 328359
20,551	27,165	7,087	6,299				
536,575	761,873	269,875	269,875	6320	15786	1115	TDI 331682
21,125	29,995	10,625	10,625				(276448/410)
558,8	736,6	196,85	196,85	4294	11448	826	TDI 331607
22	29	7,75	7,75				(377448/410)
560	820	242	242	5085	11333	820	TDI 332626
22,047	32,284	9,528	9,528				
571,5	812,8	285,75	285,75	7206	17918	1205	TDI 331476
22,5	32	11,25	11,25				(278749/710)
	812,8	285,75	285,75	7206	17918	1205	TDI 331854
	32	11,25	11,25				(278749/710)
580	830	280	280	6870	16448	1130	TDI 331677
22,835	32,677	11,024	11,024				
609,6	787,4	171,45	171,45	4047	10715	742	TDI 331858
24	31	6,75	6,75				(649241/310)
	820	171,45	171,45	4075	10597	750	TDI 332424
	32,284	6,75	6,75				
650	1030	270	270	8694	18318	1249	TDI 328306
25,591	40,551	10,630	10,630				
660,4	812,8	176,212	176,212	3540	11344	755	TDI 331198
26	32	6,938	6,938				

Dimensions			Factor	Mass	Designation
d	r _{1,2min}	r _{3,4min}	e		(AFBMA Part number)
[mm]				[kg]	
519,112 20,438	3,3	6,4	0,33	370,00	TDI 334009 (275349/310)
(cont.)					
522 20,551	1,5	4	0,79	190,00	TDI 328359
536,575 21,125	3,3	6,4	0,33	410,00	TDI 331682 (276448/410)
558,8 22	3,3	6,4	0,35	235,00	TDI 331607 (377448/410)
560 22,047	2,5	8	0,88	425,00	TDI 332626
571,5 22,5	3,3	6,4	0,33	500,00	TDI 331476 (278749/710)
	3,3	6,4	0,33	500,00	TDI 331854 (278749/710)
580 22,835	3	6	0,31	515,00	TDI 331677
609,6 24	3,3	6,4	0,37	218,00	TDI 331858 (649241/310)
	3,3	6,4	0,37	265,00	TDI 332424
650 25,591	15	10	0,31	900,00	TDI 328306
660,4 26	3,2	6,4	0,33	195,00	TDI 331198

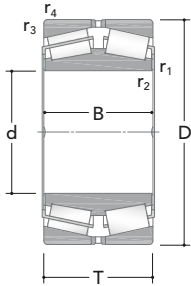

TDI

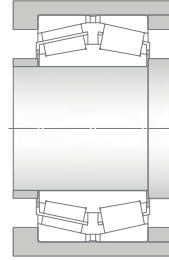

Main dimensions				Basic load ratings		Fatigue	Designation (AFBMA Part number)
d	D	T	B	Dynamic C	Static C ₀	load limit C _u	
[mm]				[kN]			
682,625	965,2	338,138	338,138	9653	24699	1619	TDI 332129
26,875	38	13,313	13,313				(282249/210)
710	900	197	197	4728	13378	868	TDI 331581
27,953	35,433	7,756	7,756				
800	1260	375	375	14658	33205	2018	TDI 334032
31,496	49,606	14,764	14,764				
863,6	1130,3	323,85	323,85	10717	30746	1875	TDI 331590
34	44,5	12,75	12,75				(286249/210)
901,7	1295,4	450,85	438,15	16563	43214	2488	TDI 331306
35,5	51	17,75	17,25				(634356/510)
939,8	1333,5	463,55	463,55	17583	49226	2737	TDI 331350
37	52,5	18,25	18,25				(287849/810)

Dimensions			Factor	Mass	Designation
d	r _{1,2min}	r _{3,4min}	e		(AFBMA Part number)
[mm]				[kg]	
682,625 26,875	3,3	6,4	0,33	815,00	TDI 332129 (282249/210)
710 27,953	3	6	0,35	325,00	TDI 331581
800 31,496	12	12	0,33	1850,00	TDI 334032
863,6 34	4,8	12,7	0,33	895,00	TDI 331590 (286249/210)
901,7 35,5	4,8	12,7	0,35	2000,00	TDI 331306 (634356/510)
939,8 37	4,8	12,7	0,33	2230,00	TDI 331350 (287849/810)

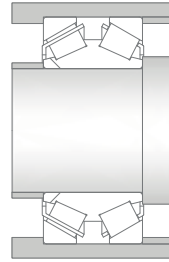
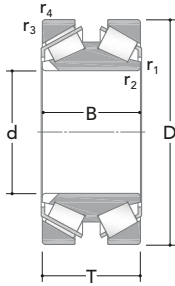

TDIS

Main dimensions				Basic load ratings		Fatigue load limit	Designation
d	D	T	B	Dynamic C	Static C ₀	C _u	
[mm]				[kN]			
300	440	105	105	1084	2053	179	TDIS 332168
305,033	560	200	200	2820	5229	436	TDIS 334087
305,07	500	200	200	2694	5266	420	TDIS 332169
	560	200	200	3106	5297	430	TDIS 332068
	560	200	200	3106	5297	430	TDIS 331617
360	560	160	160	2589	4641	391	8000
	600	200	200	3071	5851	465	8002
380	560	200	200	2784	6580	518	8009
	565	200	200	2784	6580	518	8003
386	574	220	220	2989	6557	509	TDISS 8010 ⁽¹⁾
390	570	200	200	2942	6633	504	TDIS 328896
400	650	240	240	3904	8124	622	TDIS 332167
408,4	546,1	152	160	1530	3426	287	TDISS 334053 ⁽¹⁾
445	620	160	160	2149	5163	395	TDIS 334069
460	680	180	180	3145	6973	528	TDIS 328876
510	733,5	200,025	200,025	3542	8385	639	TDIS 617670
510,13	800	285	285	5574	12722	898	TDIS 332171
520	660	140	140	2080	5664	428	8001
635	939,8	304,8	304,8	6694	16445	1110	TDIS 331555

⁽¹⁾ Bearing with steep contact angle and with seals



TDIRS

Dimensions			Factor	Mass	Designation
d	r _{1,2min}	r _{3,4min}	e		
[mm]				[kg]	
300	4	4	0,88	48,50	TDIS 332168
305,033	3,3	6,4x45°	0,88	205,00	TDIS 334087
305,07	6,4	4,8	0,88	150,00	TDIS 332169
	3,3	6	0,88	200,00	TDIS 332068
	3,3	18	0,88	200,00	TDIS 331617
360	3	5	0,72	140,00	8000
	3	5	0,94	220,00	8002
380	5	5	0,79	165,00	8009
	5	5	0,79	170,00	8003
386	3	5	0,83	185,00	TDIRS 8010 ⁽¹⁾
390	5	5	0,83	170,00	TDIS 328896
400	6,4	6,4	0,88	245,00	TDIS 332167
408,4	1	3	0,88	88,00	TDIRS 334053 ⁽¹⁾
445	2	5	0,83	135,00	TDIS 334069
460	2,5	6	0,99	210,00	TDIS 328876
510	3,3	4,8	0,88	265,00	TDIS 617670
510,13	4,8	10	0,88	505,00	TDIS 332171
520	3	5	0,68	115,00	8001
635	3,3	6,4	0,88	720,00	TDIS 331555

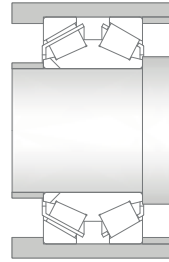
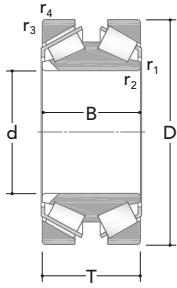

TDIS

Main dimensions				Basic load ratings		Fatigue load limit	Designation
d	D	T	B	Dynamic C	Static C ₀	C _u	
[mm]				[kN]			
800	1100	300	300	7733	21876	1323	TDIS 332394

⁽¹⁾ Bearing with steep contact angle and with seals



TDIR

Dimensions			Factor	Mass	Designation
d	r _{1,2min}	r _{3,4min}	e		
[mm]				[kg]	
800	1,5	6	0,79	850,00	TDIS 332394

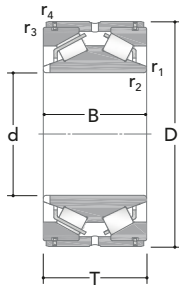

TDIS

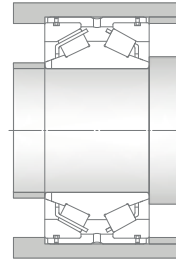

Main dimensions				Basic load ratings		Fatigue	Designation
d	D	T	B	Dynamic C	Static C ₀	load limit C _u	
[mm]				[kN]			
305,07	524	200	200	2739	5213	424	TDIS 334110
	524	220	220	2739	5213	424	TDISS 8006 ⁽¹⁾
320	524	185	185	2744	5202	425	TDIS 334152
	540	160	160	2416	4354	369	8017
390	568	180	180	2577	5904	451	TDIS 334045
	590	200	200	2959	6548	510	TDIS 328934
	590	220	220	2959	6548	510	TDISS 8011 ⁽¹⁾
	615,95	220	220	2742	6503	514	TDISS 8014 ⁽¹⁾
406,4	566,1	150	150	1948	4806	371	TDIS 334024
	580	164,275	164,275	1962	4680	313	TDISS 334085 ⁽¹⁾
408,4	570,1	152	160	1614	3444	285	TDISS 334068 ⁽¹⁾
420	620	200	200	2945	7144	564	8016
440	615,95	220	220	2101	5098	400	TDISS 8013 ⁽¹⁾
445	620	180	180	2107	5118	399	TDISS 334113 ⁽¹⁾
450	702	180	180	3178	6898	534	8018
460	702	180	180	3130	6929	532	TDIS 334030
480	660	150	150	1750	5173	392	TDIS 334100
482	640	160	160	1756	5241	387	TDIS 334112
	640	160	160	1701	4219	342	TDISS 334111 ⁽¹⁾
520	715	180	180	2823	8208	607	TDISS 334041 ⁽¹⁾

⁽¹⁾ Bearing with steep contact angle and with seals

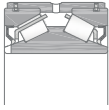

TDISS

Dimensions			Factor	Mass	Designation
d	r _{1,2min}	r _{3,4min}	e		
[mm]				[kg]	
305,07	6,4	4,8	0,88	180,00	TDIS 334110
	6,4	4,8	0,88	195,00	TDISS 8006 ⁽¹⁾
320	3	4,8	0,88	150,00	TDIS 334152
	2	5	0,83	160,00	8017
390	2	5	0,83	155,00	TDIS 334045
	5	5	0,83	200,00	TDIS 328934
	3	5	0,83	210,00	TDISS 8011 ⁽¹⁾
	3	5	0,83	250,00	TDISS 8014 ⁽¹⁾
406,4	1,5	3,3	0,83	120,00	TDIS 334024
	1,5	5	0,83	135,00	TDISS 334085 ⁽¹⁾
408,4	1	3	0,88	115,00	TDISS 334068 ⁽¹⁾
420	2	5	0,75	210,00	8016
440	2	5	0,83	185,00	TDISS 8013 ⁽¹⁾
445	2	5	0,83	160,00	TDISS 334113 ⁽¹⁾
450	2,5	6	0,99	260,00	8018
460	2,5	6	0,99	250,00	TDIS 334030
480	2	5	0,94	160,00	TDIS 334100
482	2	5	0,94	145,00	TDIS 334112
	2	5	0,88	130,00	TDISS 334111 ⁽¹⁾
520	1,5	4	0,79	220,00	TDISS 334041 ⁽¹⁾

Four-row tapered roller bearings

RKB four-row tapered roller bearings are produced mainly in TQO and TQI configuration, in open and sealed version. Supplied with the required axial internal clearance, they are mainly employed on work rolls of rolling mill applications.

The use of high quality raw materials, special heat treatments, and innovative sealing solutions are at the base of their higher operating reliability and longer service life expectancy. The bearing dimensional and running accuracy conforms to ISO/ABMA/GOST specifications.



Four-row tapered roller bearings

Bearing internal clearance

RKB four-row tapered roller bearings are normally provided in set right ready for mounting featuring a proper Bench End Play (BEP) suitable to the specific application. According to this concepts, bearing components have to be mounted strictly following a sequence and cannot be swapped each other nor used among different bearings. In order to establish the proper BEP specification for your applications, please contact the RKB application engineering services.

Minimum load

In order to get a correct functioning, double row tapered roller bearings have to be always loaded with a minimum value, in particular in case of application featuring high speed, high acceleration and/or quick variation of load direction. According to the above condition the minimum required load can be evaluated as following:

$$\frac{F_m}{C} > 0,02$$

where:

- F_m minimum radial load, [kN];
- C dynamic load rating, [kN].

Bearings fitting

RKB four-row tapered roller bearings are generally mounted "loose fit" on the roll neck. Typical roll neck tolerances can be found in the following **Tab. 19 page 397**. As regards fitting tolerances for the choke bore, typical values can be found in the following **Tab. 20 page 397**.

With reference to four-row tapered roller bearings featuring a tapered bore or applied in high speed application, please consult the application engineering services.

Four-row tapered roller bearings tolerances	Nominal dimension		Tolerances	
			Sup.	Inf.
[mm]	[mm]		[mm]	
Metric	d < 315		-0,180	-0,230
	315	<d ≤ 630	-0,240	-0,300
	630	<d ≤ 800	-0,325	-0,410
	d > 800		-0,350	-0,450
Inch	152,4	<d ≤ 203,2	-0,150	-0,175
	203,2	<d ≤ 304,8	-0,180	-0,205
	304,8	<d ≤ 609,6	-0,200	-0,249
	609,6	<d ≤ 914,4	-0,250	-0,334
	d > 914,4		-0,300	-0,400

Tab. 19 - General "loose fit" roll neck tolerances

Four-row tapered roller bearings tolerances	Nominal dimension		Tolerances	
			Sup.	Inf.
[mm]	[mm]		[mm]	
Metric	d ≤ 800		H6	
	> 800		H7	
Inch	304,8	<d ≤ +609,6	+0,101	+0,150
	609,6	<d ≤ +914,4	+0,156	+0,230
	914,4	<d ≤ +1219,2	+0,202	+0,300
	d > 1219,6		+0,257	+0,380

Tab. 20 - General choke bore tolerances

Designs and variants

Type TQO₁

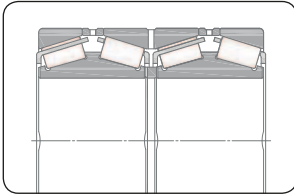

- One double cup, two single cups, plus two cup spacers (plain or with lubrication grooves and holes)
- Two double cones, plus one cone spacer (plain or with lubrication holes)
- Four one-piece window type steel cages
- Supports radial and axial loads in both directions
- Preset or adjusted BEP on customer's request
- Available with helical groove in the bore (G)
- Marked zones on cups side face to easy mounting and maintenance operations
- Available in metric and inch sizes
- Optimized roller profile

Type TQO₂

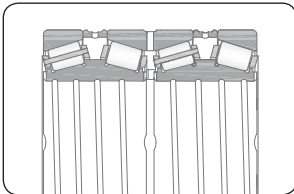

- One double cup, two single cups, plus two cup spacers (plain or with lubrication grooves and holes)
- Two double cones, plus one cone spacer (plain or with lubrication holes)
- Four two-piece steel pin-type cages
- Pierced roller execution to increase load rating capacities
- Preset or adjusted BEP on customer's request
- Available with helical groove in the bore (G)
- Marked zones on cups side face to easy mounting and maintenance operations

- mounting and maintenance operations
- Available in metric and inch sizes
 - Optimized roller profile

Type TQO₃

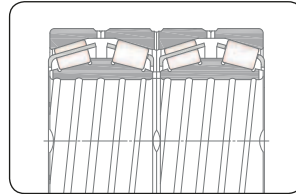

- One double cup, two single cups
- Two double cones
- Four one-piece window type pressed steel cages
- Supports radial and axial loads in both directions
- Available with helical groove in the bore (G)
- Lubrication grooves in double cone side faces
- Marked zones on cups sides face to easy mounting and maintenance operations
- Available in metric and inch sizes
- Optimized roller profile

Type TQOE

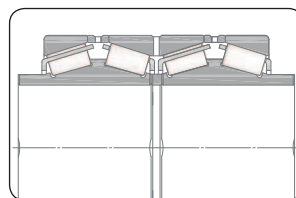

- One double cup, two single cups, plus two cup spacers (plain or with lubrication grooves and holes)
- Two double cones, plus one cone spacer (plain or with lubrication holes)
- Four one-piece window type steel cages
- With extended inner ring on both sides for radial shaft seals
- Supports radial and axial loads in both directions

- Preset or adjusted BEP on customer's request
- Available with helical groove in the bore (G)
- Marked zones on cups side face to easy mounting and maintenance operations
- Available in metric and inch sizes
- Optimized roller profile

Type SET2xTDI

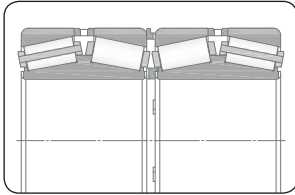

HB BAINITE HT	S STABILIZATION
O+ OPTIMIZED	PROFILE

- Four ribless cups plus three spacers (plain or with lubrication grooves and holes)
- Two double cones with three ribs
- Four pin-type cages
- Preset or adjusted BEP on customer's request
- Marked zones on cups side face to easy mounting and maintenance operations
- Available in metric and inch sizes
- Better internal distribution of the external loads due to the four single cups compared with TQO design
- Optimized roller profile

Type TQI

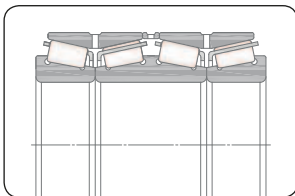

HB BAINITE HT	S STABILIZATION
PROFILE	

- Two double cup, plus one cup spacer (plain or with lubrication grooves and holes)
- One double cone, two single cones
- Four one-piece window type steel cages
- Preset or adjusted BEP on customer's request
- Available with helical groove in the bore (G)
- Marked zones on cups side face to easy mounting and maintenance operations

- Available in metric and inch sizes
- Optimized roller profile

Type TQIT

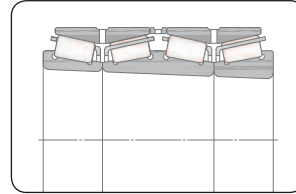

HB BAINITE HT	S STABILIZATION
PROFILE	

- Two double cup, plus one cup spacer (plain or with lubrication grooves and holes)
- One double cone, two single cones featuring tapered bore
- Four one-piece window type steel cages
- Preset or adjusted BEP on customer's request
- Available with helical groove in the bore (G)
- Marked zones on cups side face to easy mounting and maintenance operations
- Available in metric and inch sizes
- Optimized roller profile

Type TQITE

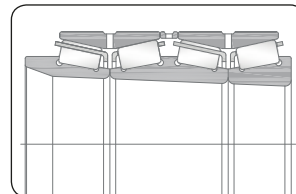

HB BAINITE HT	S STABILIZATION
PROFILE	

- Two double cup, plus one cup spacer (plain or with lubrication grooves and holes)
- One double cone, two single cones featuring tapered bore
- Four one-piece window type steel cages
- Preset or adjusted BEP on customer's request
- Available with helical groove in the bore (G)
- Marked zones on cups side face to easy mounting and maintenance operations
- Available in metric and inch sizes
- Optimized roller profile
- With extended inner ring on one side for radial shaft seal

Type TQOT

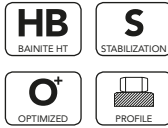
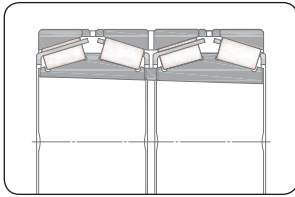

- One double cup, two single cups, plus two cup spacers (plain or with lubrication grooves and holes)
- Two two double cones, plus one cone spacer (plain or with lubrication holes)
- Four one-piece window type steel cages
- Supports radial and axial loads in both directions
- Preset or adjusted BEP on customer's request
- Tapered bore
- Marked zones on cups side face to easy mounting and maintenance operations
- Available in metric and inch sizes
- Optimized roller profile

Type TQOS₂

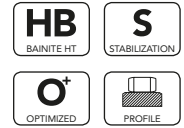
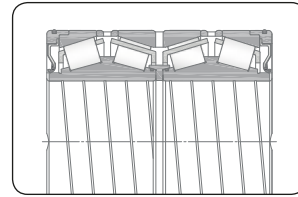

- One double cup, two single cups plus two cup spacers (plain or with lubrication grooves and holes)
- Two double cones with three ribs
- Four one-piece window type steel cages
- Preset or adjusted BEP on customer's request
- Marked zones on cups side faces to easy mounting and maintenance operations
- Lateral flanges, concentric to the single cups, with improved seal lip and O-rings
- Designed with Anti-Vortex System cone spacer seal set
- Available in metric and inch sizes
- Optimized roller profile

Type TQOS₁

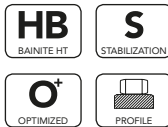
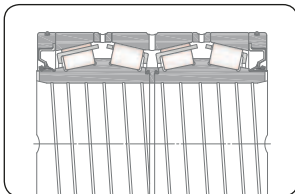

- One double cup, two single cups, plus two cup spacers (plain or with lubrication grooves and holes)
- Two double cones
- Four one-piece window type steel cages
- Preset or adjusted BEP on customer's request
- Marked zones on cups side face to facilitate mounting and maintenance operations
- Lateral flanges with lip seals and o-rings on bearing both sides
- Designed with Anti-Vortex System cone spacer seal set
- Available in metric and inch sizes
- Optimized roller profile

Type TQOS₃

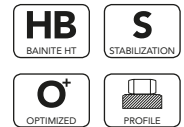
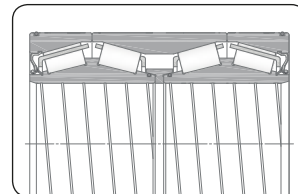

- One double cup, two single cups with integrated lateral flanges, featuring O-ring and rotating lip seals
- Two double cones with three ribs
- Four one-piece window type steel cages
- Preset or adjusted BEP on customer's request
- Marked zones on cups side face to easy mounting and maintenance operations
- Designed with Anti-Vortex System cone spacer seal set
- Available in metric and inch sizes
- Completely sealed (re-lubrication process is not possible!)
- Optimized roller profile

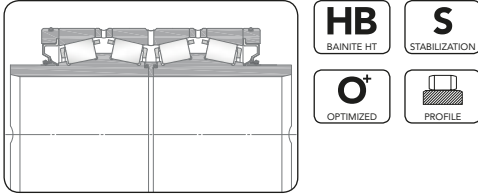
Type TQOES

- One double cup, two single cups, plus two cup spacers (plain or with lubrication grooves and holes)
- Two double cones with extended inner ring on both sides for radial shaft seals
- Four one-piece window type steel cages
- Preset or adjusted BEP on customer's request
- Marked zones on cups side face to facilitate mounting and maintenance operations
- Lateral flanges with lip seals and o-rings on bearing both sides
- Designed with Anti-Vortex System cone spacer seal set
- Available in metric and inch sizes
- Optimized roller profile

Suffixes	Internal design
B	In TQO bearings, special double cones width. The number immediately following the B gives the double cones width in mm
SP	Special or non-standard bearing
BT4B	Four-row tapered roller bearing
ZB	Optimized roller profile for improved load distribution. It is not necessarily stated in the bearing code

Suffixes	Accuracy, clearance, running
HP	High precision (better than P6)
ST	Special tolerance

Suffixes	External design
AVSx	Anti-vortex system
AVSxC	Anti-vortex system with compact seals
1C	Compact seal and O-ring on both sides



Part numbering

First system

	Section 1	Section 2	Section 3	Section 4	Section 5
	Configuration	Boundary dimensions	Execution	Material and heat treatment of bearing components	Special surface treatment
	TQO, TQI, TQIT, TQOS, TQOE, TQITE, TQOT	dxDxT/DxTxd	A1...An, AA, AB, AD, AC1, A1B etc. indicating major or minor revision based on: customer's request; application requirement, echnology or design advancement, presence of special features. The meaning of such combination of characters and numbers may vary from bearing to bearing	HB1...HB7 HA1...HA7	PT1...PT7 AWT1...AWT7 ACT1...ACT3
Example	TQO	101510/506250	AA2	HA4	PT4
		d: 10,50 inches = 266,700 mm D: 15,50 inches = 393,700 mm T: 10,62 inches = 269,748 mm	As basic TQO configuration, but with special Bench End Play	Case hardened bearing components	Phosphate treated cones, cup and rollers

Tab. 21 (1 of 2) - First system: structure

Section 6	Section 7	Section 8	Section 9	Section 10
Roller features	Final bearing specification	K	$r_{1,2 \text{ min}}$ $r_{3,4 \text{ min}}$	Suffix
ZB	BT4B	The three figures immediately following the K indicates the K thrust value without a decimal mark	The four figures immediately following the three digits of the K value indicate the minimum values in mm of radii 1,2 and 3,4 without decimal marks	Different features from standard version
ZB	BT4B	K145	3364	VL
Optimized roller profile for improved load distribution	Four-row tapered roller bearing	K: 1,45	$r_{1,2 \text{ min}}: 3,3 \text{ mm}$ $r_{3,4 \text{ min}}: 6,4 \text{ mm}$	Victory Line

Tab. 21 (2 of 2) - First system: structure

Second system

	Section 1	Section 2	Section 3	Section 4
	Configuration	Drawing number	Execution	Material and heat treatment of bearing components
	TQO, TQI, TQIT, TQOS, TQOE, TQITE, TQOT	Up to six digits	A1...An, AA, AB, AD, AE1, A1B etc. indicating major or minor revision based on: customer's request, application requirement, technology or design advancement, presence of special features. Typically the meaning of such combination of alphabetical and numerical characters vary from bearing to bearing	HB1...HB7 HA1...HA7
Example	TQIT	101411	AA	HB4
		No dimension indication	As basic TDI configuration, but with lubrication grooves in side faces of double cone	Bainite hardened bearing components

Tab. 22 (1 of 2) - Second system: structure

Section 5	Section 6	Section 7	Section 8
Special surface treatment	Roller features	Final bearing specification	Suffix
PT1...PT7 AWT1...AWT7 ACT1...ACT3	ZB	BT4B	Different features from standard version
ACT1	ZB	BT4B	VL
Anticorrosion treated	Optimized roller profile for improved load distribution	Four-row tapered roller bearing	Victory Line

Tab. 22 (2 of 2) - Second system: structure

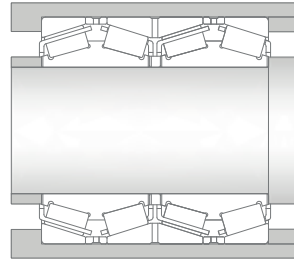
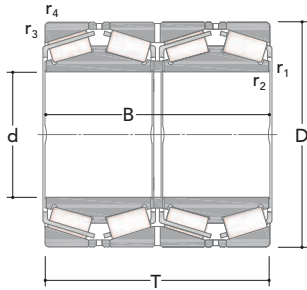

TQO₁

Main dimensions				Basic load ratings		Fatigue	Designation
d	D	T	B	Dynamic C	Static C ₀	load limit C _u	(AFBMA Part number)
[mm]				[kN]			
120,65	174,625	139,703	141,288	733	1542	172	TQO 332406
4,75	6,875	5,500	5,563				(224749/710/710)
127	182,562	158,75	158,75	779	1743	182	TQO 330880
5	7,188	6,25	6,25				(48290/220/220)
139,7	200,025	160,34	157,162	864	2079	204	TQO 331138
5,5	7,875	6,313	6,188				(48685/620/620)
152,4	222,25	174,625	174,625	1136	2477	252	TQO 331329
6	8,75	6,875	6,875				(231649/610/610)
165,1	225,425	168,275	165,1	868	2226	206	TQO 330835
6,5	8,875	6,625	6,5				(46791/720/721)
177,8	247,65	192,088	192,088	1220	2985	281	TQO 331480
7	9,75	7,563	7,563				(67790/720/721)
187,325	269,875	211,138	211,138	1655	3851	360	TQO 331382
7,375	10,625	8,313	8,313				(238849/810/810)
	269,875	211,138	211,138	1655	3851	360	TQO 328881
	10,625	8,313	8,313				(238849/810/810)
190,5	266,7	188,912	187,325	1349	3278	278	TQO 331249
7,5	10,5	7,438	7,375				(67885/820/820)
198,438	284,162	225,425	225,425	1795	4124	392	TQO 330899
7,813	11,188	8,875	8,875				(240648/611/611)
205	320	203,5	203,5	1896	3623	348	TQO 328065
8,071	12,598	8,012	8,012				

⁽¹⁾ Bearing with inner ring extended at both sides

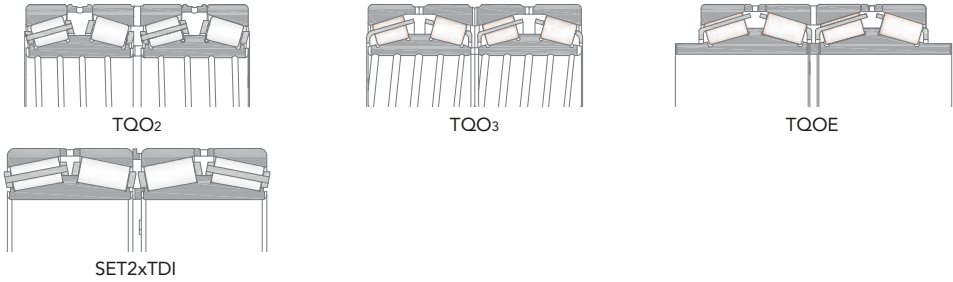

Dimensions			Factor	Mass	Designation
d	r _{1,2min}	r _{3,4min}	e		(AFBMA Part number)
[mm]				[kg]	
120,65 4,75	0,8	1,5	0,33	11,00	TQO 332406 (224749/710/710)
127 5	1,5	3,3	0,3	14	TQO 330880 (48290/220/220)
139,7 5,5	0,8	3,3	0,33	15,5	TQO 331138 (48685/620/620)
152,4 6	1,5	1,5	0,33	22,5	TQO 331329 (231649/610/610)
165,1 6,5	0,8	3,3	0,37	20,50	TQO 330835 (46791/720/721)
177,8 7	1,5	3,3	0,44	29,00	TQO 331480 (67790/720/721)
187,325 7,375	1,5	3,3	0,33	41	TQO 331382 (238849/810/810)
	1,5	3,3	0,33	41,00	TQO 328881 (238849/810/810)
190,5 7,5	1,5	3,3	0,48	33,50	TQO 331249 (67885/820/820)
198,438 7,813	1,5	3,3	0,33	47,50	TQO 330899 (240648/611/611)
205 8,071	4	3	0,46	54,50	TQO 328065

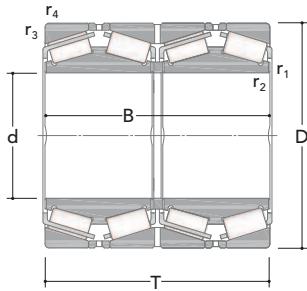

TQO₁

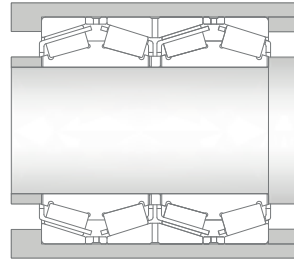

Main dimensions				Basic load ratings		Fatigue	Designation
d	D	T	B	Dynamic C	Static C ₀	load limit C _u	(AFBMA Part number)
[mm]				[kN]			
206,375	282,575	190,5	190,5	1314	3305	309	TQO 331486
8,125	11,125	7,5	7,5				(67985/920/921)
220	320	200	200	1757	4009	384	TQO 328348
8,661	12,598	7,874	7,874				
	340	303,5	303,5	3066	6695	600	TQO 328003
	13,386	11,949	11,949				
220,662	314,325	239,712	239,712	2177	5185	466	TQO 331156
8,688	12,375	9,438	9,438				(244249/210/210)
228,6	311,15	200,025	200,025	1775	4056	379	TQO 332637
9	12,25	7,875	7,875				(245149/110/110)
234,95	327,025	196,85	196,85	1540	4251	380	TQO 331399
9,25	12,875	7,75	7,75				(8576/20/20)
240	338	248	248	2396	5504	490	TQO 328015
9,449	13,307	9,764	9,764				
	360	218	218	2467	4776	452	TQO 328663
	14,173	8,583	8,583				
	360	308,5	308,5	3268	7308	659	TQO 328508
	14,173	12,146	12,146				
241,224	355,498	228,6	228,6	2190	5064	449	TQO 331787
9,497	13,996	9	9				(127094/138/139)
241,478	349,148	228,6	228,6	2190	5064	449	TQO 330782
9,507	13,746	9	9				(127097/135/136)
244,475	327,025	193,675	193,675	1837	4325	388	TQO 330862
9,625	12,875	7,625	7,625				(247748/710/710)

⁽¹⁾ Bearing with inner ring extended at both sides

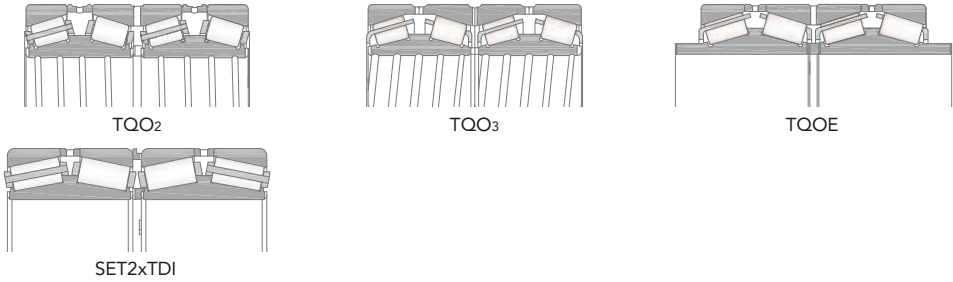

Dimensions			Factor	Mass	Designation
d	r _{1,2min}	r _{3,4min}	e		(AFBMA Part number)
[mm]				[kg]	
206,375 8,125	0,8	3,3	0,5	36,50	TQO 331486 (67985/920/921)
220 8,661	1	3	0,33	54	TQO 328348
	4	3	0,43	100	TQO 328003
220,662 8,688	1,5	3,3	0,33	61,50	TQO 331156 (244249/210/210)
228,6 9	1,5	3,3	0,33	43,5	TQO 332637 (245149/110/110)
234,95 9,25	1,5	3,3	0,4	54	TQO 331399 (8576/20/20)
240 9,449	4	3	0,4	70	TQO 328015
	1,5	4	0,31	75,50	TQO 328663
	4	3	0,33	110,00	TQO 328508
241,224 9,497	1,5	3,3	0,35	81,50	TQO 331787 (127094/138/139)
241,478 9,507	1,5	3,3	0,35	74,50	TQO 330782 (127097/135/136)
244,475 9,625	1,5	3,3	0,33	46,00	TQO 330862 (247748/710/710)

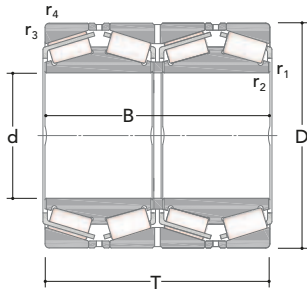

TQO₁

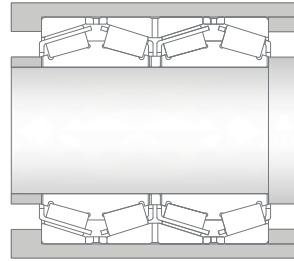

Main dimensions				Basic load ratings		Fatigue	Designation
d	D	T	B	Dynamic C	Static C ₀	load limit C _u	(AFBMA Part number)
[mm]				[kN]			
244,475	381	304,8	304,8	2934	6765	579	TQO 328690
9,625	15	12	12				(126096/150/151)
(cont.)							
245	380	254	255,5	2670	5670	504	TQO 331398
9,646	14,961	10	10,059				
247,65	400,05	253,995	249,235	2921	6287	561	TQO 614096
9,75	15,75	10,000	9,812				(220975/1575/1576)
254	358,775	269,875	269,875	2884	7073	622	TQO 331275
10	14,125	10,625	10,625				(249749/710/710)
	358,775	269,875	339,725	2884	7073	622	TQO 329070 ⁽¹⁾
	14,125	10,625	13,375				
260	440	298,5	298,5	3957	7450	661	TQO 328551
10,236	17,323	11,725	11,725				
260,35	422,275	317,5	314,325	4102	8070	704	TQO 331487
10,25	16,625	12,5	12,375				(252349/310/310)
266,7	355,6	228,6	230,188	2110	5599	500	TQO 330822
10,5	14	9	9,063				(76589/520/520)
	355,6	228,6	230,188	2215	5600	500	TQO 328209
	14	9	9,063				(451349/310/310)
269,875	381	282,575	282,575	3068	7410	663	TQO 331168
10,625	15	11,125	11,125				(2523490/310/3100)
276,225	393,7	269,875	269,878	3001	6390	571	TQO 331288
10,875	15,5	10,625	10,625				(275109/155/156)
279,4	381	269,875	269,875	2904	7393	649	TQO 328293
11	15	10,625	10,625				

⁽¹⁾ Bearing with inner ring extended at both sides

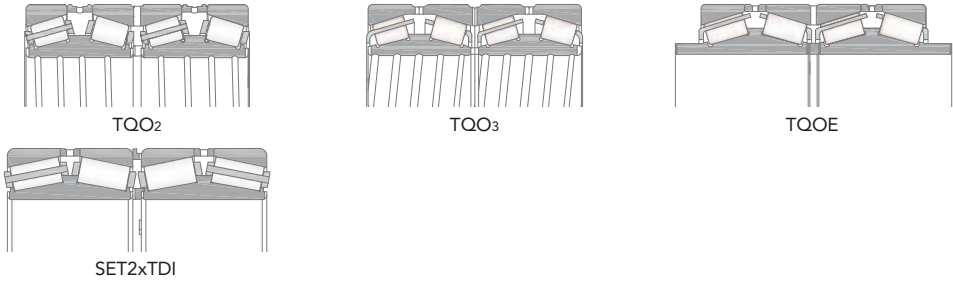

Dimensions			Factor	Mass	Designation
d	r _{1,2min}	r _{3,4min}	e		(AFBMA Part number)
[mm]				[kg]	
244,475 9,625 (cont.)	3,3	4,8	0,52	130,00	TQO 328690 (126096/150/151)
245 9,646	1,5	4	0,44	105,00	TQO 331398
247,65 9,75	1,5	6,4	0,4	120,00	TQO 614096 (220975/1575/1576)
254 10	1,5	3,3	0,33	88,00	TQO 331275 (249749/710/710)
	1,5	3,3	0,33	92,50	TQO 329070 ⁽¹⁾
260 10,236	2,5	5	0,54	190,00	TQO 328551
260,35 10,25	6,4	3,3	0,33	180,00	TQO 331487 (252349/310/310)
266,7 10,5	1,5	3,3	0,37	65,50	TQO 330822 (76589/520/520)
	1,5	3,3	0,35	65,50	TQO 328209 (451349/310/310)
269,875 10,625	3,3	3,3	0,33	105,00	TQO 331168 (2523490/310/3100)
276,225 10,875	1,5	6,4	0,4	100	TQO 331288 (275109/155/156)
279,4 11	1,5	3,3	0,35	91	TQO 328293

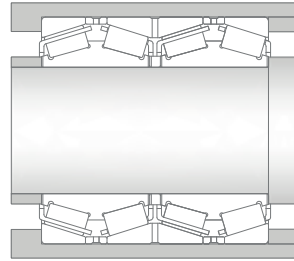
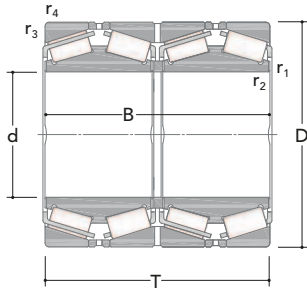

TQO₁

Main dimensions				Basic load ratings		Fatigue	Designation
d	D	T	B	Dynamic C	Static C ₀	load limit C _u	(AFBMA Part number)
[mm]				[kN]			
279,4	393,7	269,875	269,875	3026	7110	609	TQO 332390
11	15,5	10,625	10,625				(135111/155/156)
(cont.)							
279,578	380,898	244,475	244,475	2283	6323	547	TQO 330540
11,007	14,996	9,625	9,625				(654644/610/610)
280	380	290	290	3066	8055	690	TQO 328613
11,024	14,961	11,417	11,417				
	380	290	290	2961	7700	679	TQO 328681
	14,961	11,417	11,417				
	395	288	288	3499	8387	713	TQO 328807
	15,551	11,339	11,339				
	395	288	288	2882	7440	660	TQO 328882
	15,551	11,339	11,339				
	420	250	250	3202	6453	579	TQO 328664
	16,535	9,843	9,843				
	460	324	324	4673	9342	811	TQO 332441
	18,110	12,756	12,756				
285,75	380,898	244,475	244,475	2291	6445	536	TQO 330337
11,25	14,996	9,625	9,625				(654648/610/610)
288,925	406,4	298,45	298,45	3581	9088	743	TQO 331452
11,375	16	11,75	11,75				(255449/410/410)
292,1	422,275	269,875	269,875	3797	8039	677	TQO 331968
11,5	16,625	10,625	10,625				(330116/166/167)
300	440	279,4	280,988	3206	7689	680	TQO 328725
11,811	17,323	11	11,063				
	460	388,5	388,5	5454	12649	988	TQO 332472
	18,110	15,295	15,295				

⁽¹⁾ Bearing with inner ring extended at both sides

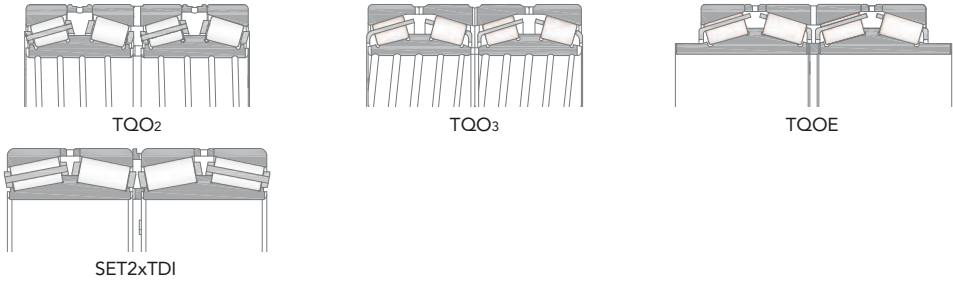

Dimensions			Factor	Mass	Designation
d	r _{1,2min}	r _{3,4min}	e		(AFBMA Part number)
[mm]				[kg]	
279,4 11 (cont.)	1,5	6,4	0,37	102	TQO 332390 (135111/155/156)
279,578 11,007	1,5	3,3	0,43	86,00	TQO 330540 (654644/610/610)
280 11,024	1	2,5	0,28	95,00	TQO 328613
	2,2	4,3	0,33	95,50	TQO 328681
	2,5	4	0,28	110,00	TQO 328807
	2	6	0,37	115,00	TQO 328882
	2	5	0,35	115	TQO 328664
	6	6	0,35	215,00	TQO 332441
285,75 11,25	1,5	3,3	0,43	81	TQO 330337 (654648/610/610)
288,925 11,375	3,3	3,3	0,33	125,00	TQO 331452 (255449/410/410)
292,1 11,5	6,4	3,3	0,31	125	TQO 331968 (330116/166/167)
300 11,811	3,3	4,8	0,43	145	TQO 328725
	5	5	0,33	240,00	TQO 332472

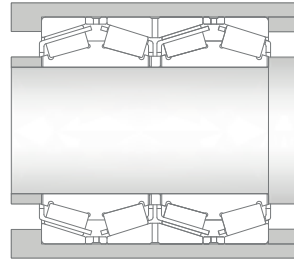
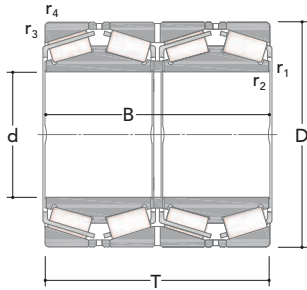

TQO₁

Main dimensions				Basic load ratings		Fatigue	Designation
d	D	T	B	Dynamic C	Static C ₀	load limit C _u	(AFBMA Part number)
[mm]				[kN]			
300,038	422,275	311,15	311,15	3838	9533	797	TQO 331287
11,813	16,625	12,25	12,25				(256849/810/810)
304,648	438,048	279,4	280,99	3046	6941	586	TQO 328828
11,994	17,246	11	11,063				
	438,048	279,4	280,99	3390	7990	509	TQO 331492
	17,246	11	11,063				(757448/410/410)
304,8	419,1	269,875	269,875	3357	8076	686	TQO 331687
12	16,5	10,625	10,625				(257149/110/110)
	482,6	377,825	365,125	4960	10297	874	TQO 330693
	19	14,875	14,375				
304,902	412,648	266,7	266,7	2980	7990	601	TQO 330758
12,004	16,246	10,5	10,5				(257248/210/210)
317,5	422,275	269,875	269,875	3333	8206	675	TQO 330870
12,5	16,625	10,625	10,625				(258648/610/610)
	438,15	276,225	276,225	3515	8223	702	TQO 334020
	17,25	10,875	10,875				
	447,675	327,025	327,025	4681	10949	868	TQO 331161
	17,625	12,875	12,875				(259049/010/010)
330,2	444,5	301,625	301,625	3733	9725	794	TQO 332647
13	17,5	11,875	11,875				(260149/110/110)
330,302	438,023	254	247,65	2577	7323	602	TQO 331664
13,004	17,245	10	9,75				(138131/172/173)
333,375	469,9	342,9	342,9	4578	11419	928	TQO 331381
13,125	18,5	13,5	13,5				(261049/010/010)

⁽¹⁾ Bearing with inner ring extended at both sides

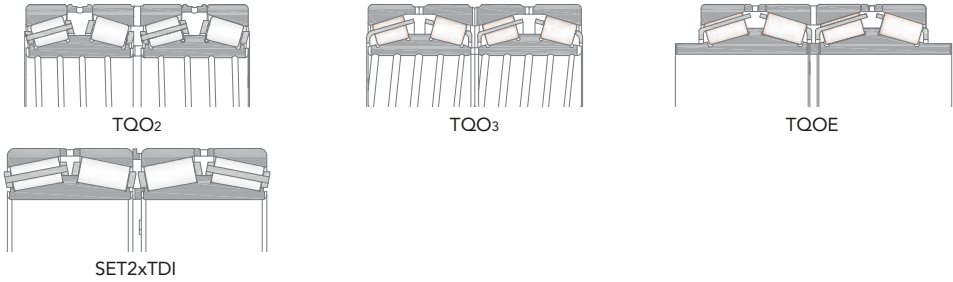

Dimensions			Factor	Mass	Designation
d	r _{1,2min}	r _{3,4min}	e		(AFBMA Part number)
[mm]				[kg]	
300,038 11,813	3,3	3,3	0,33	140,00	TQO 331287 (256849/810/810)
304,648 11,994	2x15°	4,8	0,48	135,00	TQO 328828
	3,3	4,8	0,48	135,00	TQO 331492 (757448/410/410)
304,8 12	1,5	6,4	0,33	110,00	TQO 331687 (257149/110/110)
	3,3	3,3	0,35	265,00	TQO 330693
304,902 12,004	3,3	3,3	0,31	105,00	TQO 330758 (257248/210/210)
317,5 12,5	1,5	3,3	0,31	105,00	TQO 330870 (258648/610/610)
	1,5	3,3	0,43	125	TQO 334020
	3,3	3,3	0,33	165,00	TQO 331161 (259049/010/010)
330,2 13	3,3	3,3	0,33	135,00	TQO 332647 (260149/110/110)
330,302 13,004	1,5	3,3	0,46	110	TQO 331664 (138131/172/173)
333,375 13,125	3,3	3,3	0,33	190	TQO 331381 (261049/010/010)

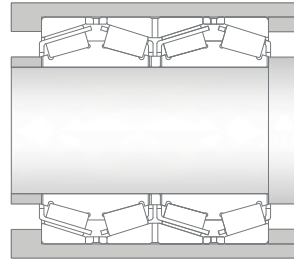
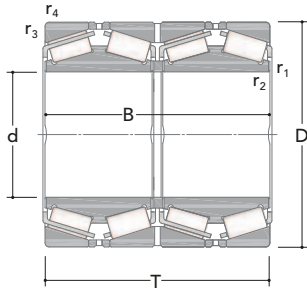

TQO1

Main dimensions				Basic load ratings		Fatigue	Designation
d	D	T	B	Dynamic C	Static C ₀	load limit C _u	(AFBMA Part number)
[mm]				[kN]			
340	520	323,5	323,5	5529	10259	892	TQO 332963
13,386	20,472	12,736	12,736				
342,9	571,5	342,9	342,54	6330	11767	937	TQO 331553
13,5	22,5	13,5	13,486				
343,052	457,098	254	254	3411	6780	572	TQO 330661
13,506	17,996	10	10				(761649/610/610)
346,075	488,95	358,775	358,775	5211	12657	1007	TQO 331228
13,625	19,508	14,125	14,125				(262749/710/710)
347,662	469,9	260,35	260,35	3801	10147	834	TQO 331077
13,688	18,5	10,25	10,25				(262449/410/410)
	469,9	292,1	292,1	3801	10147	834	TQO 331092
	18,5	11,5	11,5				(262449/410/410)
355	490	316	316	4164	10859	891	TQO 331508
13,976	19,291	12,441	12,441				
355,6	482,6	269,875	265,113	3962	7887	664	TQO 330662
14	19	10,625	10,438				(763449/410/410)
	488,95	317,5	317,5	4090	11090	873	TQO 331271
	19,25	12,5	12,5				(263349/310/310)
360	510	380	380	5678	14139	1133	TQO 332059
14,173	20,079	14,961	14,961				
	540	280	280	4359	8886	744	TQO 328159
	21,26	11,024	11,024				
368,3	523,875	382,588	382,588	6353	14841	1172	TQO 331159
14,5	20,625	15,063	15,063				(265049/010/010)

⁽¹⁾ Bearing with inner ring extended at both sides

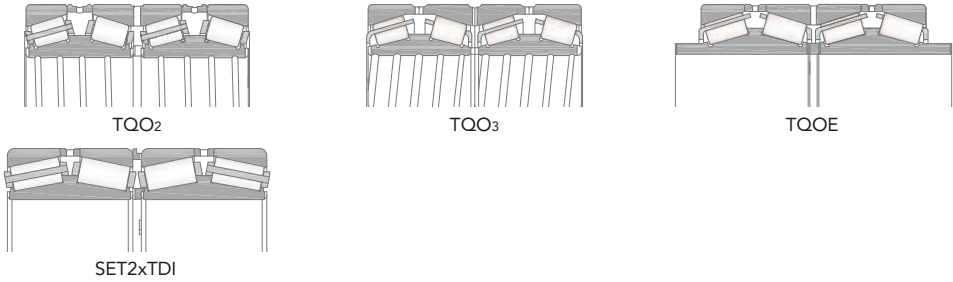

Dimensions			Factor	Mass	Designation
d	r _{1,2min}	r _{3,4min}	e		(AFBMA Part number)
[mm]				[kg]	
340 13,386	1,5	5	0,3	245	TQO 332963
342,9 13,5	3,3	6,4	0,33	365,00	TQO 331553
343,052 13,506	1,5	3,3	0,48	110,00	TQO 330661 (761649/610/610)
346,075 13,625	3,3	3,3	0,33	220,00	TQO 331228 (262749/710/710)
347,662 13,688	1,5	3,3	0,33	130	TQO 331077 (262449/410/410)
	3,3	3,3	0,33	150,00	TQO 331092 (262449/410/410)
355 13,976	1,5	3,3	0,33	185,00	TQO 331508
355,6 14	1,5	3,3	0,48	140,00	TQO 330662 (763449/410/410)
	1,5	3,3	0,33	195	TQO 331271 (263349/310/310)
360 14,173	2	6	0,33	255,00	TQO 332059
	5	5	0,44	230	TQO 328159
368,3 14,5	3,3	6,4	0,33	275	TQO 331159 (265049/010/010)

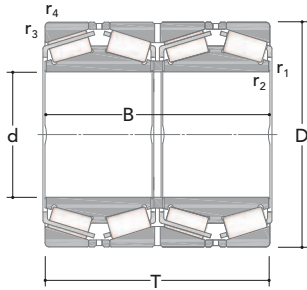

TQO1

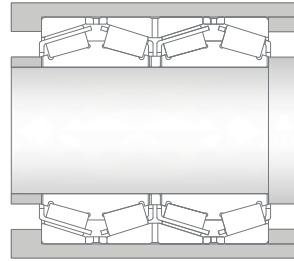

Main dimensions				Basic load ratings		Fatigue	Designation
d	D	T	B	Dynamic C	Static C ₀	load limit C _u	(AFBMA Part number)
[mm]				[kN]			
374,65	501,65	260,35	250,825	3362	8094	675	TQO 332188
14,75	19,75	10,25	9,875				(765149/110/110)
380	560	325	325	5532	11867	945	TQO 328294
14,961	22,047	12,795	12,795				
	560	360	360	6090	13552	1092	TQO 328816
	22,047	14,173	14,173				
	620	388	388	6952	13609	1087	TQO 332889
	24,409	15,276	15,276				
384,175	546,1	400,05	400,05	7999	16498	1298	TQO 331149
15,125	21,5	15,75	15,75				(266449/410/410)
385,762	514,35	317,5	317,5	4248	12029	928	TQO 331202
15,188	20,25	12,5	12,5				(665949/910/910)
395	545	288,9	268	4744	9641	739	TQO 332824
15,551	21,457	11,374	10,551				
406,4	546,1	288,925	268,288	3953	9372	760	TQO 331465
16	21,5	11,375	10,563				(234161/215/216)
	546,1	288,925	288,925	4900	10239	812	TQO 330650
	21,5	11,375	11,375				(767749/710/710)
	565,15	381	381	5984	15429	1234	TQO 331347
	22,25	15	15				(267949/910/910)
	590,55	400,05	400,05	6866	16731	1260	TQO 331133
	23,25	15,75	15,75				(833161 /232/233)
409,575	546,1	334,962	334,962	4976	13159	1003	TQO 331333
16,125	21,5	13,188	13,188				(667947/910/910)
	546,1	334,962	334,962	4443	12533	962	TQO 328967
	21,5	13,188	13,188				

⁽¹⁾ Bearing with inner ring extended at both sides

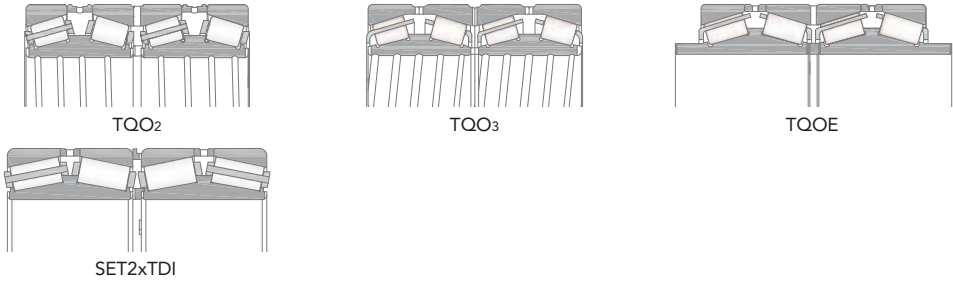

Dimensions			Factor	Mass	Designation
d	r _{1,2min}	r _{3,4min}	e		(AFBMA Part number)
[mm]				[kg]	
374,65 14,75	1,5	3,3	0,48	140	TQO 332188 (765149/110/110)
380 14,961	2	5	0,31	265,00	TQO 328294
	2	6	0,4	295	TQO 328816
	6	6	0,43	438,00	TQO 332889
384,175 15,125	3,3	6,4	0,33	310,00	TQO 331149 (266449/410/410)
385,762 15,188	3,3	3,3	0,43	190	TQO 331202 (665949/910/910)
395 15,551	5	10	0,48	195	TQO 332824
406,4 16	1,5	6,4	0,48	185	TQO 331465 (234161/215/216)
	1,5	6,4	0,48	185,00	TQO 330650 (767749/710/710)
	3,3	6,4	0,33	300,00	TQO 331347 (267949/910/910)
	3,3	6,4	0,33	370	TQO 331133 (833161 /232/233)
409,575 16,125	1,5	6,4	0,43	220,00	TQO 331333 (667947/910/910)
	6,4	6,4	0,43	220	TQO 328967

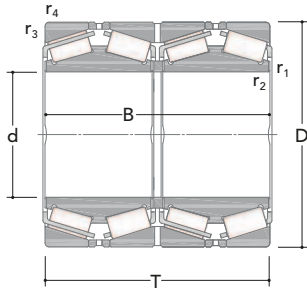

TQO₁

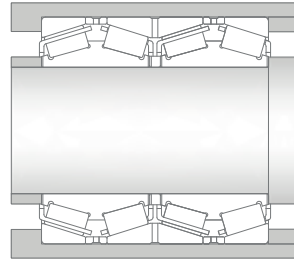

Main dimensions				Basic load ratings		Fatigue	Designation
d	D	T	B	Dynamic C	Static C ₀	load limit C _u	(AFBMA Part number)
[mm]				[kN]			
415,925	590,55	434,975	434,975	7260	19538	1442	TQO 331160
16,375	23,25	17,125	17,125				(268749/710/710)
420	560	437	437	5906	16390	1213	TQO 328826
16,535	22,047	17,205	17,205				
	620	355	355	6427	14516	1126	TQO 328374
	24,409	13,976	13,976				
430	570	336,55	336,55	4977	14158	1048	TQO 331192
16,923	22,441	13,25	13,25				
431,8	571,5	279,4	279,4	3716	9641	931	TQO 331125
17	22,5	11	11				(869449/410/410)
	571,5	279,4	279,4	3716	9641	931	TQO 331125
	22,5	11	11				(869449/410/410)
	571,5	336,55	336,55	5280	14128	1050	TQO 331226
	22,5	13,25	13,25				(769349/310/310)
	635	355,6	355,6	6608	14840	1173	TQO 332060
	25	14	14				(931070/250/251)
	635	355,6	440	6608	14840	1173	TQO 334019
	25	14	17,323				(¹⁾)
440	580	420	420	6068	17671	1315	TQO 328829
17,323	22,835	16,535	16,535				
	650	353,5	353,5	6578	15067	1155	TQO 332313
	25,591	13,917	13,917				
444,5	571,5	336,55	336,55	4956	14334	1077	TQO 328670
17,5	22,5	13,25	13,25				
447,675	635	463,55	463,55	8153	22238	1583	TQO 330608
17,625	25	18,25	18,25				(270749/710/710)

⁽¹⁾ Bearing with inner ring extended at both sides

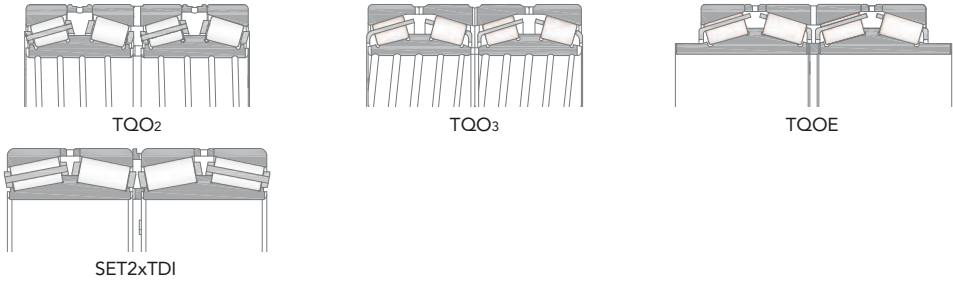

Dimensions			Factor	Mass	Designation
d	r _{1,2min}	r _{3,4min}	e		(AFBMA Part number)
[mm]				[kg]	
415,925 16,375	3,3	6,4	0,33	395	TQO 331160 (268749/710/710)
420 16,535	4	6	0,31	285,00	TQO 328826
	2	5	0,31	375,00	TQO 328374
430 16,923	1,5	3,3	0,44	240,00	TQO 331192
431,8 17	1,5	3,3	0,54	200,00	TQO 331125 (869449/410/410)
	1,5	3,3	0,54	200,00	TQO 331125 (869449/410/410)
	1,5	3,3	0,54	240	TQO 331226 (769349/310/310)
	6,4	6,4	0,33	385,00	TQO 332060 (931070/250/251)
	6,4	6,4	0,33	405,00	TQO 334019 ⁽¹⁾
440 17,323	4,5	6,7	0,26	300,00	TQO 328829
	6,4	6,4	0,33	410	TQO 332313
444,5 17,5	1,5	3,3	0,31	215	TQO 328670
447,675 17,625	3,3	6,4	0,33	485	TQO 330608 (270749/710/710)

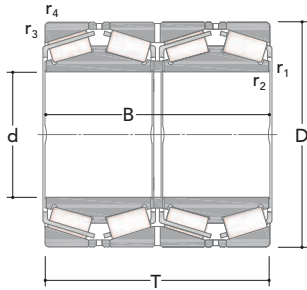

TQO₁

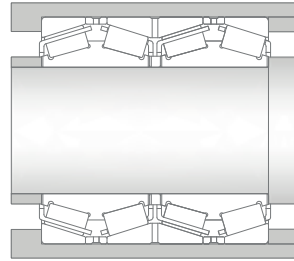

Main dimensions				Basic load ratings		Fatigue	Designation
d	D	T	B	Dynamic C	Static C ₀	load limit C _u	(AFBMA Part number)
[mm]				[kN]			
450	580	450	450	6155	19665	1395	TQO 328161
17,717	22,835	17,717	17,717				
	595	368	368	6744	16295	1220	TQO 332773
	23,425	14,488	14,488				(270449/410/410)
	595	404	404	6794	16367	1215	TQO 328365
	23,425	15,906	15,906				(270449/410)
457,073	730,148	419,1	412,75	8927	19484	1469	TQO 328287
17,995	28,746	16,5	16,25				(671798/2873/2875)
457,2	596,9	279,4	276,225	4515	10870	825	TQO 331169
18	23,5	11	10,875				(770847/810/810)
	596,9	279,4	276,225	4515	10870	825	TQO 331169
	23,5	11	10,875				(770847/810/810)
	596,9	320	320	4907	13663	1023	TQO 334006
	23,5	12,598	12,598				
460	610	360	360	7462	16453	1238	TQO 331977
18,110	24,016	14,173	14,173				
	610	400	400	6316	17344	1287	TQO 328285
	24,018	15,748	15,748				
	625	421	421	7118	19864	1470	TQO 332502
	24,606	16,575	16,575				(271149/110/110)
462	615,95	330,2	330,2	5544	15011	1119	TQO 328692
18,189	24,25	13	13				
475	600	368	368	5652	16545	1254	TQO 328913
18,701	23,622	14,488	14,488				
	660	450	450	8659	22666	1641	TQO 329007
	25,984	17,717	17,717				

⁽¹⁾ Bearing with inner ring extended at both sides

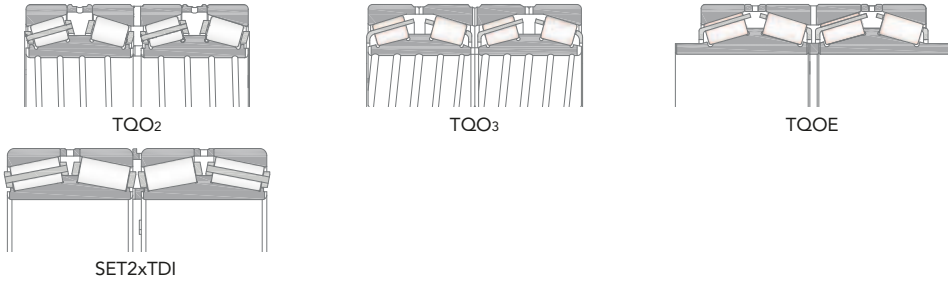

Dimensions			Factor	Mass	Designation
d	r _{1,2min}	r _{3,4min}	e		(AFBMA Part number)
[mm]				[kg]	
450	3	6	0,24	280,00	TQO 328161
17,717	3	6	0,33	285	TQO 332773 (270449/410/410)
	3	6	0,33	305,00	TQO 328365 (270449/410)
457,073	1,5	6,4	0,4	630,00	TQO 328287 (671798/2873/2875)
17,995					
457,2	1,5	3,3	0,48	200	TQO 331169 (770847/810/810)
18	1,5	3,3	0,48	200,00	TQO 331169 (770847/810/810)
	3,3	3,3	0,44	235,00	TQO 334006
460	3	6	0,33	295,00	TQO 331977
18,110	2,5	4	0,28	315	TQO 328285
	3	9	0,33	382,00	TQO 332502 (271149/110/110)
462	3,3	6,4	0,4	275,00	TQO 328692
18,189					
475	2	6	0,3	250,00	TQO 328913
18,701	4	6	0,3	460,00	TQO 329007

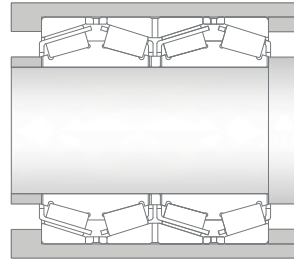
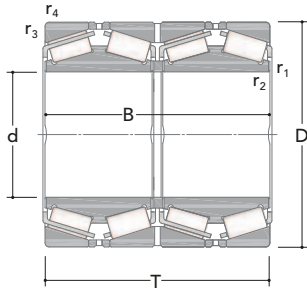

TQO1

Main dimensions				Basic load ratings		Fatigue	Designation
d	D	T	B	Dynamic C	Static C ₀	load limit C _u	(AFBMA Part number)
[mm]				[kN]			
479,425	679,45	495,3	495,3	9477	22507	1829	TQO 330886
18,875	26,75	19,5	19,5				(272749/710/710)
482,6	615,95	330,2	330,2	6283	15204	1127	TQO 332096
19	24,25	13	13				(272248/210/210)
	615,95	330,2	330,2	6283	15204	1127	TQO 330641
	24,25	13	13				(272249/210/210)
	615,95	330,2	419,1	6283	15204	1127	TQO 331626
	24,25	13	16,5				(272249/210/210)
	630	420	420	6681	19072	1417	TQO 328773
	24,803	16,535	16,535				
	647,7	417,512	417,512	7608	19801	1475	TQO 331259
	25,5	16,438	16,438				(272647/610/610)
488,95	622,3	365,125	365,125	5649	17213	1297	TQO 328391
19,25	24,5	14,375	14,375				
489,026	634,873	320,675	320,675	6261	14678	1074	TQO 331090
19,253	24,995	12,625	12,625				(243193/250/251)
	634,873	320,675	320,675	6261	14678	1074	TQO 328282
	24,995	12,625	12,625				(772749/710/710)
500	720	400	400	8235	20117	1481	TQO 328524
19,685	28,347	15,748	15,748				
501,65	673,1	387,35	400,05	7226	19251	1464	TQO 331499
19,75	26,5	15,25	15,75				(641198/265/266)
	711,2	520,7	520,7	10131	27268	1977	TQO 331081
	28	20,5	20,5				(274149/110/110)
508	762	463,55	463,55	10184	23202	1700	TQO 332131
20	30	18,25	18,25				(531201/300/301)

(1)

(1) Bearing with inner ring extended at both sides

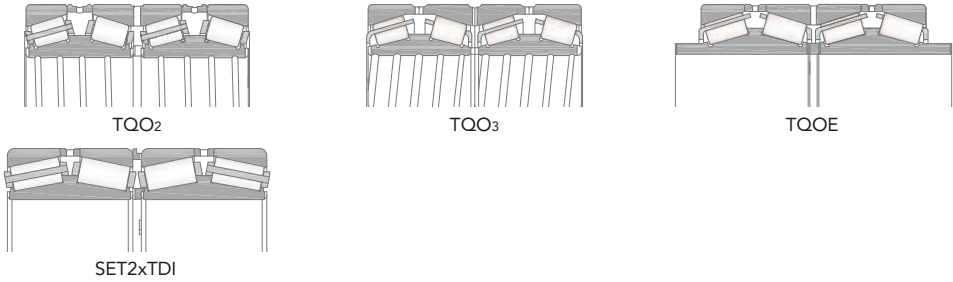

Dimensions			Factor	Mass	Designation
d	r _{1,2min}	r _{3,4min}	e		(AFBMA Part number)
[mm]				[kg]	
479,425 18,875	3,3	6,4	0,33	605,00	TQO 330886 (272749/710/710)
482,6 19	6,4	6,4	0,33	245	TQO 332096 (272248/210/210)
	3,3	6,4	0,33	245,00	TQO 330641 (272249/210/210)
	3,5	6,4	0,33	265,00	TQO 331626 ⁽¹⁾ (272249/210/210)
	3,3	6,4	0,33	345	TQO 328773
	3,3	6,4	0,33	400,00	TQO 331259 (272647/610/610)
488,95 19,25	3	3	0,35	265	TQO 328391
489,026 19,253	3,3	3,3	0,35	270,00	TQO 331090 (243193/250/251)
	3,3	3,3	0,48	270,00	TQO 328282 (772749/710/710)
500 19,685	3	6	0,35	550,00	TQO 328524
501,65 19,75	3,3	6,4	0,31	395,00	TQO 331499 (641198/265/266)
	3,3	6,4	0,33	755,00	TQO 331081 (274149/110/110)
508 20	6,4	6,4	0,37	730,00	TQO 332131 (531201/300/301)

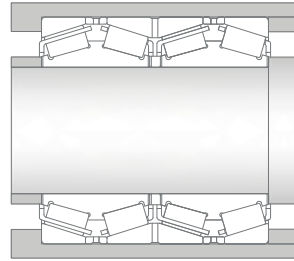
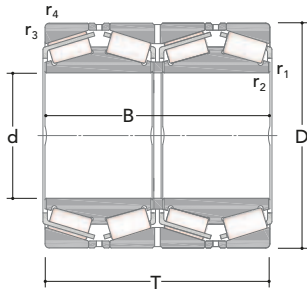

TQO₁

Main dimensions				Basic load ratings		Fatigue	Designation
d	D	T	B	Dynamic C	Static C ₀	load limit C _u	(AFBMA Part number)
[mm]				[kN]			
510	655	379	377	7751	19012	1369	TQO 331747
20,079	25,787	14,921	14,843				
514,35	673,1	422,275	422,275	7314	21645	1557	TQO 331157
20,25	26,5	16,625	16,625				(274449/410/410)
519,112	736,6	536,575	536,575	11452	30993	2160	TQO 331078
20,438	29	21,125	21,125				(275349/310/310)
520,7	711,2	400,05	400,05	7485	19611	1459	TQO 331243
20,5	28	15,75	15,75				(275349/310/310)
536,575	761,873	558,8	558,8	11637	31563	2230	TQO 331174
21,125	29,995	22	22				(276449/410/410)
540	690	400	400	7452	20937	1519	TQO 331978
21,260	27,165	15,748	15,748				
	690	400	434	7452	20937	1519	TQO 334038
	27,165	15,748	17,087				⁽¹⁾
558,8	736,6	322,268	322,265	6196	16536	1225	TQO 331165
22	29	12,688	12,688				(843221/290/291)
	736,6	409,575	409,575	8459	23072	1639	TQO 330993
	29	16,125	16,125				(377449/410/410)
	736,6	457,2	455,612	8363	25875	1809	TQO 331346
	29	18	17,938				(277149/110/110)
560	920	618	618	16422	34130	2311	TQO 328509
22,047	36,221	24,331	24,331				
571,5	812,8	593,725	593,725	11935	32353	2136	TQO 330529
22,5	32	23,375	23,375				(278749/710/710)

⁽¹⁾ Bearing with inner ring extended at both sides

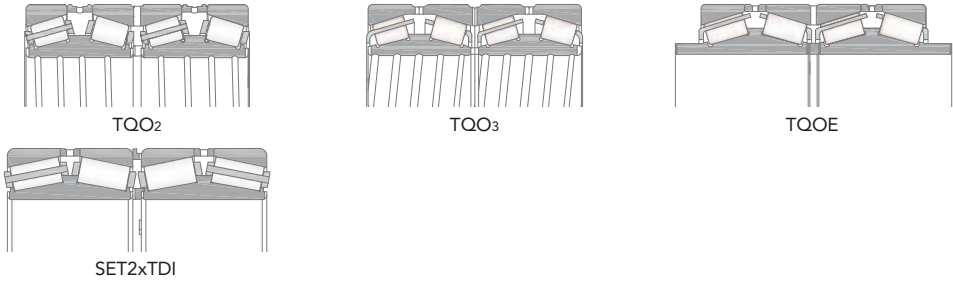

Dimensions			Factor	Mass	Designation
d	r _{1,2min}	r _{3,4min}	e		(AFBMA Part number)
[mm]				[kg]	
510 20,079	1,5	6,4	0,33	330,00	TQO 331747
514,35 20,25	3,3	6,4	0,31	410,00	TQO 331157 (274449/410/410)
519,112 20,438	3,3	6,4	0,33	755,00	TQO 331078 (275349/310/310)
520,7 20,5	3,3	6,4	0,33	460,00	TQO 331243 (275349/310/310)
536,575 21,125	3,3	6,4	0,33	835,00	TQO 331174 (276449/410/410)
540 21,260	3	6	0,33	375,00	TQO 331978
	1	5	0,33	400,00	TQO 334038 ⁽¹⁾
558,8 22	3,3	6,4	0,35	375,00	TQO 331165 (843221/290/291)
	3,3	6,4	0,35	475,00	TQO 330993 (377449/410/410)
	3,3	6,4	0,33	545,00	TQO 331346 (277149/110/110)
560 22,047	7,5	7,5	0,4	1700,00	TQO 328509
571,5 22,5	3,3	6,4	0,33	1000,00	TQO 330529 (278749/710/710)

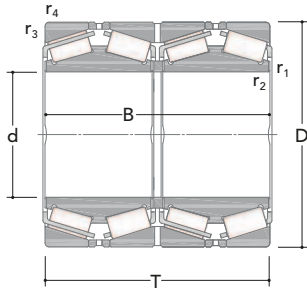

TQO₁

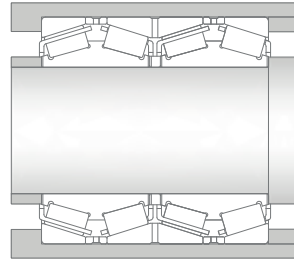

Main dimensions				Basic load ratings		Fatigue	Designation
d	D	T	B	Dynamic C	Static C ₀	load limit C _u	(AFBMA Part number)
[mm]				[kN]			
584,2	730,25	349,25	342,9	5930	16897	1207	TQO 331189
23	28,75	13,75	13,5				
	762	401,638	396,875	7693	22714	1538	TQO 331148
	30	15,813	15,625				(778549/510/510)
	901,7	539,747	523,08	13379	28233	1983	TQO 328314
	35,5	21,250	20,594				(665231/355/356)
585,788	771,525	479,425	479,425	10485	29770	2056	TQO 331093
23,063	30,375	18,875	18,875				(278849/810/810)
595,312	844,55	615,95	615,95	17180	38848	2560	TQO 331300
23,438	33,25	24,25	24,25				(280049/010/010)
596,9	980	609,6	604,838	16947	36561	2446	TQO 331566
23,5	38,583	24	23,813				
600	870	488	488	12548	29361	2015	TQO 328350
23,622	34,252	19,213	19,213				
603,25	857,25	622,3	622,3	18223	40468	2702	TQO 331625
23,622	33,75	24,5	24,5				(280249/210/210)
609,6	787,4	361,95	361,95	7344	21081	1508	TQO 331175
24	31	14,25	14,25				(649241/310/311)
	813,562	479,425	479,425	10753	30094	2108	TQO 331925
	32,03	18,875	18,875				(280249/210/210)
	863,6	660,4	660,4	14972	40963	2735	TQO 332391
	34	26	26				(280349/310/310)
620	800	363,5	363,5	7589	21395	1545	TQO 328510
24,409	31,496	14,311	14,311				

⁽¹⁾ Bearing with inner ring extended at both sides

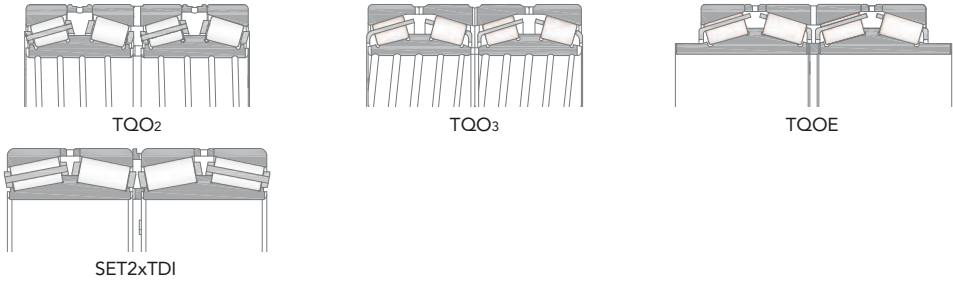

Dimensions			Factor	Mass	Designation
d	r _{1,2min}	r _{3,4min}	e		(AFBMA Part number)
[mm]				[kg]	
584,2	1,5	3,3	0,43	330,00	TQO 331189
23	3,3	6,4	0,48	485,00	TQO 331148 (778549/510/510)
	3,3	9,7	0,33	1250,00	TQO 328314 (665231/355/356)
585,788	3,3	6,4	0,33	625,00	TQO 331093 (278849/810/810)
23,063					
595,312	3,3	6,4	0,33	1115,00	TQO 331300 (280049/010/010)
23,438					
596,9	6,4	12,7	0,4	1920,00	TQO 331566
23,5					
600	3	6	0,33	940,00	TQO 328350
23,622					
603,25	3,3	6,4	0,33	1235,00	TQO 331625 (280249/210/210)
23,622					
609,6	3,3	6,4	0,37	455,00	TQO 331175 (649241/310/311)
24	3,3	6,4	0,33	715,00	TQO 331925 (280249/210/210)
	3,3	6,4	0,31	1240,00	TQO 332391 (280349/310/310)
620	3	6	0,37	465,00	TQO 328510
24,409					

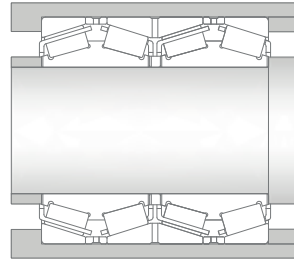
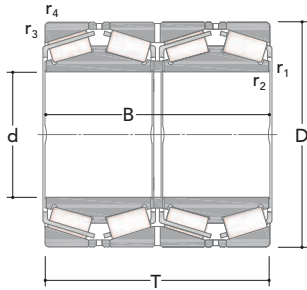

TQO₁

Main dimensions				Basic load ratings		Fatigue	Designation (AFBMA Part number)
d	D	T	B	Dynamic C	Static C ₀	load limit C _u	
[mm]				[kN]			
635	901,7	654,05	654,05	15478	45405	2874	TQO 330990
25	35,5	25,75	25,75				(281049/010/010)
646,112	857,25	542,925	542,925	12168	36998	2368	TQO 332671
25,438	33,75	21,375	21,375				(281049/310/010)
650	915	674	674	16188	44652	2923	TQO 332307
25,591	36,024	26,535	26,535				(281349/310/310)
	1030	560	560	20507	37483	2585	TQO 332827
	40,551	22,047	22,047				
657,225	933,45	676,275	676,275	17055	49516	3117	TQO 330824
25,875	36,75	26,625	26,625				(281649/610/610)
660	855	318,48	319,192	6201	17127	1211	TQO 331065
25,984	33,661	12,539	12,567				(749259/334/335)
	855	318,5	318,5	7025	18368	1337	TQO 328511
	33,661	12,539	12,539				
660,4	812,8	365,125	365,125	7128	22674	1512	TQO 331190
26	32	14,375	14,375				(281149/110/110)
676	910	620	620	14192	41420	2705	TQO 332906
26,614	35,827	24,409	24,409				
679,45	901,7	552,45	552,45	12240	36520	2359	TQO 331700
26,75	35,5	21,75	21,75				(281849/810/810)
	901,7	552,45	552,45	13063	38635	2574	TQO 331700
	35,5	21,75	21,75				(281849/810/810)
682,625	965,2	701,675	701,675	17621	49690	3220	TQO 331503
26,875	38	27,625	27,625				(282249/210/210)

⁽¹⁾ Bearing with inner ring extended at both sides

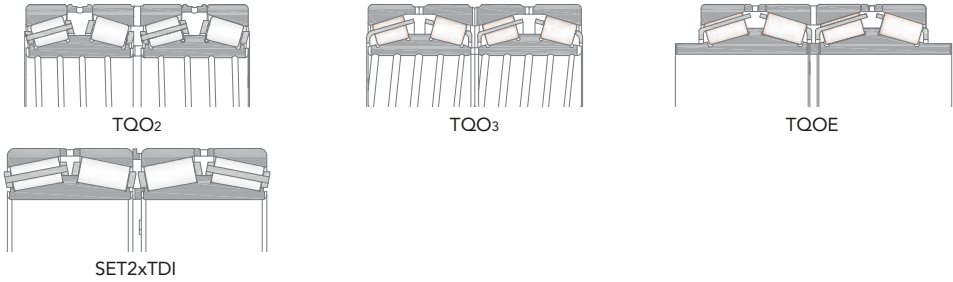

Dimensions			Factor	Mass	Designation
d	r _{1,2min}	r _{3,4min}	e		(AFBMA Part number)
[mm]				[kg]	
635 25	3,3	6,4	0,33	1420,00	TQO 330990 (281049/010/010)
646,112 25,438	3,3	6,4	0,33	875,00	TQO 332671 (281049/310/010)
650 25,591	3,3	6,4	0,33	1430,00	TQO 332307 (281349/310/310)
	15	10	0,31	1830,00	TQO 332827
657,225 25,875	3,3	6,4	0,33	1575,00	TQO 330824 (281649/610/610)
660 25,984	4,8	9,7	0,35	490,00	TQO 331065 (749259/334/335)
	5	7,5	0,35	490,00	TQO 328511
660,4 26	3,3	6,4	0,33	420,00	TQO 331190 (281149/110/110)
676 26,614	4	8	0,33	1150,00	TQO 332906
679,45 26,75	3,3	6,4	0,33	975,00	TQO 331700 (281849/810/810)
	3,3	6,4	0,33	975,00	TQO 331700 (281849/810/810)
682,625 26,875	3,3	6,4	0,33	1750,00	TQO 331503 (282249/210/210)

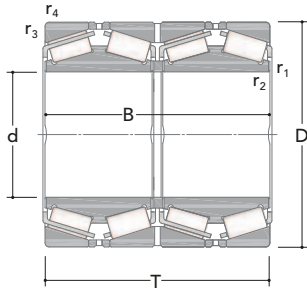

TQO₁

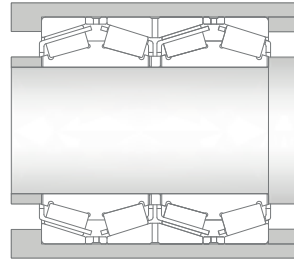

Main dimensions				Basic load ratings		Fatigue	Designation
d	D	T	B	Dynamic C	Static C ₀	load limit C _u	(AFBMA Part number)
[mm]				[kN]			
685,8	876,3	355,6	352,425	7748	21846	1511	TQO 331089
27	34,5	14	13,875				(655271/345/346)
	876,3	355,6	434,975	7748	21846	1511	TQO 328704 ⁽¹⁾
	34,5	14	17,185				(655271/345/346)
708,025	930,275	565,15	565,15	12966	39519	2467	TQO 332098
27,875	36,625	22,25	22,25				(282549/510/510)
710	900	410	410	9885	27367	1776	TQO 331351
27,953	35,433	16,142	16,142				(882449/410/410)
711,2	914,4	317,5	317,5	7128	19399	1333	TQO 330882
28	36	12,5	12,5				(755281/360/361)
714,375	1016	704,85	704,85	18561	52548	3379	TQO 331358
28,125	40	27,75	27,75				(383240/210/210)
717,55	946,15	565,15	565,15	14600	41048	2565	TQO 332244
28,25	37,25	22,25	22,25				(282847/810/810)
730	940	500	500	12042	35988	2361	TQO 331752
28,740	37,008	19,685	19,685				
730,25	1035,05	755,65	755,65	20735	59334	3549	TQO 330803
28,75	40,75	29,75	29,75				(283449/410/410)
749,3	990,6	605	605	15078	45533	2848	TQO 331616
29,5	39	23,819	23,819				(283649/610/610)
	1066,8	736,6	723,9	20802	58386	3607	TQO 331094
	42	29	28,5				(325296/420/421)
750	1130	690	690	20147	46755	2884	TQO 328376
29,528	44,488	27,165	27,165				

⁽¹⁾ Bearing with inner ring extended at both sides

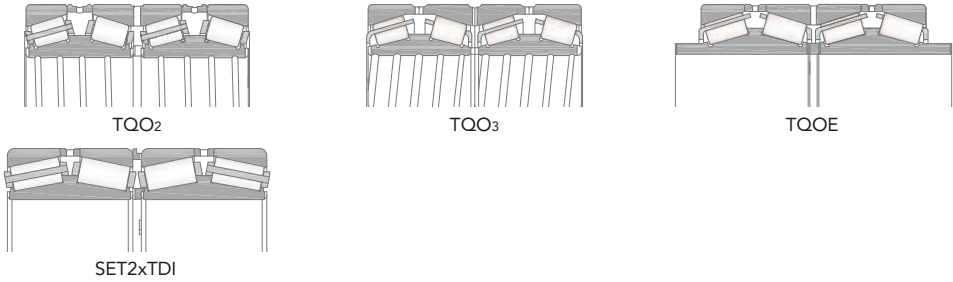

Dimensions			Factor	Mass	Designation
d	r _{1,2min}	r _{3,4min}	e		(AFBMA Part number)
[mm]				[kg]	
685,8	3,3	6,4	0,43	530,00	TQO 331089
27	3,3	6,4	0,43	580,00	TQO 328704 ⁽¹⁾
					(655271/345/346)
708,025	3,3	6,4	0,33	1030,00	TQO 332098
27,875					(282549/510/510)
710	3	6	0,35	660,00	TQO 331351
27,953					(882449/410/410)
711,2	3,3	6,4	0,37	525,00	TQO 330882
28					(755281/360/361)
714,375	3,3	6,4	0,35	1950,00	TQO 331358
28,125					(383240/210/210)
717,55	3,3	6,4	0,33	1090,00	TQO 332244
28,25					(282847/810/810)
730	3,5	8	0,35	925,00	TQO 331752
28,740					
730,25	3,3	6,4	0,33	2170,00	TQO 330803
28,75					(283449/410/410)
749,3	3,3	6,4	0,33	1250,00	TQO 331616
29,5	25,4x20°	12,7	0,33	2250,00	TQO 331094
					(325296/420/421)
750	4	7,5	0,48	2430,00	TQO 328376
29,528					

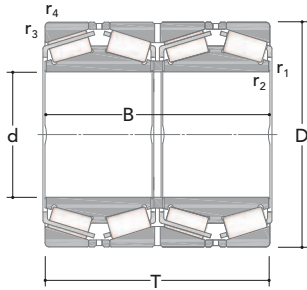

TQO₁

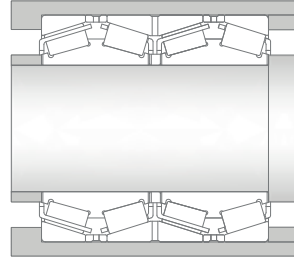

Main dimensions				Basic load ratings		Fatigue load limit	Designation
d	D	T	B	Dynamic C	Static C ₀	C _u	(AFBMA Part number)
[mm]				[kN]			
762	1066,8	736,6	723,9	20470	58999	3570	TQO 331907
30	42	29	28,5				(284148/111/110)
	1079,5	787,4	787,4	22465	65453	3903	TQO 330676
	42,5	31	31				(284249/210/210)
812,8	1143	768,35	768,35	22167	62211	3848	TQO 331248
32	45	30,25	30,25				
825,5	1168,4	844,55	844,55	26136	76633	4492	TQO 331066
32,5	46	33,25	33,25				(285848/810/810)
850	1360	910	910	34320	83506	4870	TQO 331069
33,465	53,543	35,827	35,827				
863,6	1130,3	669,925	669,925	19881	61183	3800	TQO 331123
34	44,5	26,375	26,375				(286249/210/210)
	1169,987	844,55	844,55	23750	75500	4458	TQO 332967
	46,063	33,25	33,25				
	1181,1	666,75	666,75	21167	57246	3535	TQO 331649
	46,5	26,25	26,25				(286449/410/410)
	1219,2	889	876,3	27993	81888	4727	TQO 330742
	48	35	34,5				(547341/480/481)
877,888	1220	844,55	844,55	28498	76695	4538	TQO 332981
34,563	48,032	33,25	33,25				(286749/711)
901,7	1295,4	914,4	901,7	30914	86063	5025	TQO 330903
35,5	51	36	35,5				(634356/510/510)
938,213	1270	825,5	825,5	25894	81015	4678	TQO 330726
36,938	50	32,5	32,5				(287649/610/610)

⁽¹⁾ Bearing with inner ring extended at both sides

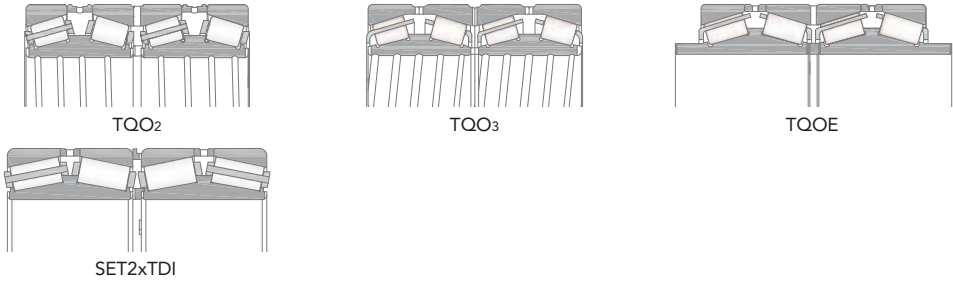

Dimensions			Factor	Mass	Designation
d	r _{1,2min}	r _{3,4min}	e		(AFBMA Part number)
[mm]				[kg]	
762	8	12,7	0,33	2145,00	TQO 331907
30	4,8	12,7	0,33	2480,00	(284148/111/110) TQO 330676 (284249/210/210)
812,8	6,4	12,7	0,33	2590,00	TQO 331248
32					
825,5	4,8	12,7	0,33	3050,00	TQO 331066
32,5					(285848/810/810)
850	6	12	0,35	5440,00	TQO 331069
33,465					
863,6	4,8	12,7	0,33	1900,00	TQO 331123
34	4,8	12,7	0,33	2700,00	(286249/210/210) TQO 332967
	4,8	12,7	0,33	2150,00	TQO 331649
	4,8	12,7	0,33	3470,00	(286449/410/410) TQO 330742 (547341/480/481)
877,888	4,8	12,7	0,33	3080,00	TQO 332981
34,563					(286749/711)
901,7	4,8	12,7	0,33	4170,00	TQO 330903
35,5					(634356/510/510)
938,213	4,8	12,7	0,35	3230,00	TQO 330726
36,938					(287649/610/610)

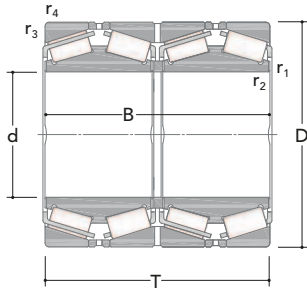

TQO1

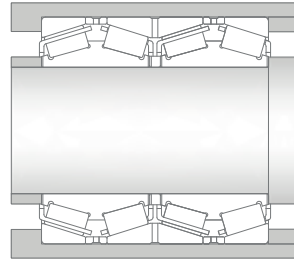

Main dimensions				Basic load ratings		Fatigue load limit	Designation
d	D	T	B	Dynamic C	Static C ₀	C _u	(AFBMA Part number)
[mm]				[kN]			
939,8	1333,5	952,5	952,5	31458	96192	5234	TQO 330944
37	52,5	37,5	37,5				(287849/210/210)
1001	1360	800	800	29448	84928	4804	TQO 334031
39,409	53,543	31,496	31,496				
1003,3	1358,9	800,1	800,1	29448	84928	4804	TQO 331372
39,5	53,5	31,5	31,5				
1070	1400	889,762	889,762	29880	99665	5518	TQO 328100
42,126	55,118	35,03	35,03				
1080	1450	950	950	33924	107919	5854	TQO 331559
42,520	57,087	37,402	37,402				
1139,825	1509,712	923,925	923,925	33681	108066	5846	TQO 331334
44,875	59,438	36,375	36,375				
1200,15	1593,85	990,6	990,600	38465	126226	6635	TQO 331440
47,25	62,75	39	39				(288949/910/910)
1250	1550	890	890	30295	114505	5974	TQO 328819
49,213	61,024	35,039	35,039				
1260	1640	1000	1000	39228	141797	7009	TQO 332124
49,606	64,567	39,370	39,370				
1300	1720	1040	1040	43182	140847	7306	TQO 331950
51,181	67,717	40,945	40,945				
1370	1765	1050	1035	43166	152304	7836	TQO 331349
53,937	69,488	41,339	40,748				

⁽¹⁾ Bearing with inner ring extended at both sides

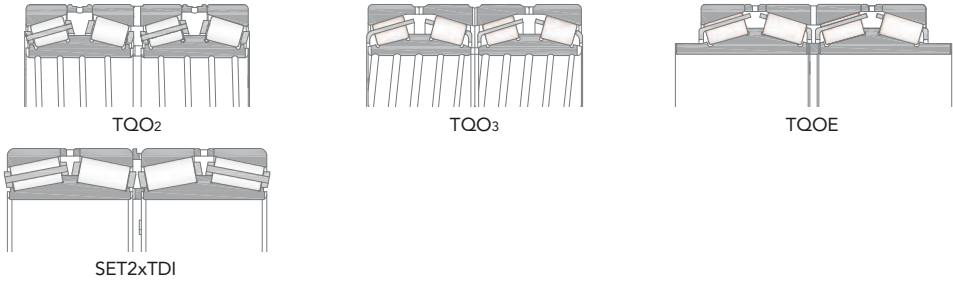

Dimensions			Factor	Mass	Designation
d	r _{1,2min}	r _{3,4min}	e		(AFBMA Part number)
[mm]				[kg]	
939,8 37	4,8	12,7	0,33	4510,00	TQO 330944 (287849/210/210)
1001 39,409	12	12,7	0,31	3390,00	TQO 334031
1003,3 39,5	4,8	12,7	0,31	3450,00	TQO 331372
1070 42,126	4	12	0,33	3730,00	TQO 328100
1080 42,520	5	12	0,33	4450,00	TQO 331559
1139,825 44,875	4,8	12,7	0,31	4840,00	TQO 331334
1200,15 47,25	4,8	12,7	0,33	5635,00	TQO 331440 (288949/910/910)
1250 49,213	5	12	0,33	3820,00	TQO 328819
1260 49,606	5	12	0,31	5800,00	TQO 332124
1300 51,181	5	12	0,33	7000,00	TQO 331950
1370 53,937	5	12	0,33	6960,00	TQO 331349

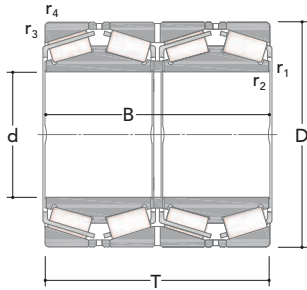

TQO1

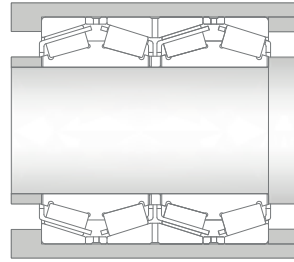

Main dimensions				Basic load ratings		Fatigue	Designation
d	D	T	B	Dynamic C	Static C ₀	load limit C _u	(AFBMA Part number)
[mm]				[kN]			
1500	1900	1080	1080	46113	170498	8276	TQO 332078
59,055	74,803	42,520	42,520				
1580	1960	1080	1080	45216	174547	8722	TQO 331934
62,205	77,165	42,520	42,520				

⁽¹⁾ Bearing with inner ring extended at both sides

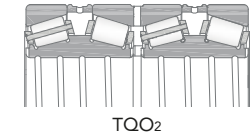

TQO₂

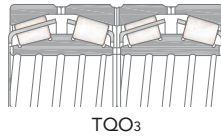

TQO₃

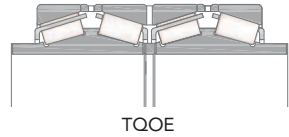

TQOE

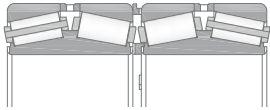

SET2xTDI

Dimensions			Factor	Mass	Designation
d	r _{1,2min}	r _{3,4min}	e		(AFBMA Part number)
[mm]				[kg]	
1500 59,055	4	12	0,35	7700,00	TQO 332078
1580 62,205	5	12	0,33	7800,00	TQO 331934

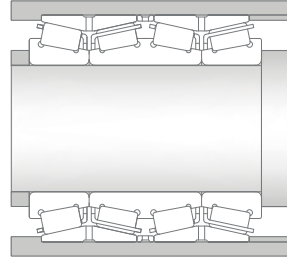
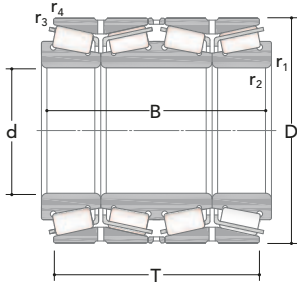

TQI

Main dimensions				Basic load ratings		Fatigue	Designation
d	D	T	B	Dynamic C	Static C ₀	load limit C _u	(AFBMA Part number)
[mm]				[kN]			
254	358,775	257,175	292,1	2833	7107	619	TQI 332610
10	14,125	10,125	11,5				(249749/710)
279,4	407	288	320	3526	9131	754	TQI 328345
11	16,024	11,339	12,598				(255449/411)
317,5	422,275	261,938	290,514	3108	8179	678	TQI 332642
12,5	16,625	10,313	11,438				(258649/610)
333,375	469,9	328,612	366,712	4582	11354	934	TQI 328083
13,125	18,5	12,938	14,438				
347,662	469,9	246,063	280,194	3575	8523	708	TQI 331807
13,688	18,5	9,688	11,031				
368,3	523,875	366,712	411,162	5856	14858	1171	TQI 334011
14,5	20,625	14,438	16,188				
384,175	546,1	384,175	428,625	6477	16620	1288	TQI 331809
15,125	21,5	15,125	16,875				
400	540	295	330	4858	12674	967	TQI 332297
15,748	21,260	11,614	12,992				
406,4	590,55	381	434,975	7026	16586	1271	TQI 328923
16	23,25	15	17,125				
415,925	590,55	419,1	469,9	7224	19443	1449	TQI 332814
16,375	23,25	16,5	18,5				
431,8	571,5	320,675	366,713	5001	13824	1073	TQI 331999
17	22,5	12,625	14,438				

Dimensions			Factor	Mass	Designation
d	r _{1,2min}	r _{3,4min}	e		(AFBMA Part number)
[mm]				[kg]	
254 10	3,5	1,5	0,33	90,50	TQI 332610 (249749/710)
279,4 11	3,5	1,5	0,33	140	TQI 328345 (255449/411)
317,5 12,5	6,5	1,5	0,31	110	TQI 332642 (258649/610)
333,375 13,125	6,4	1,5	0,33	190	TQI 328083
347,662 13,688	3,3	1,5	0,33	135,00	TQI 331807
368,3 14,5	6,4	1,5	0,33	275,00	TQI 334011
384,175 15,125	6,4	1,5	0,33	300	TQI 331809
400 15,748	3,3	1,5	0,31	210,00	TQI 332297
406,4 16	9,7	1,5	0,33	370	TQI 328923
415,925 16,375	6,4	1,5	0,33	405,00	TQI 332814
431,8 17	6,4	1,5	0,44	250	TQI 331999

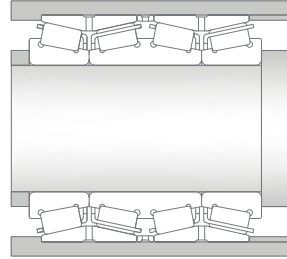
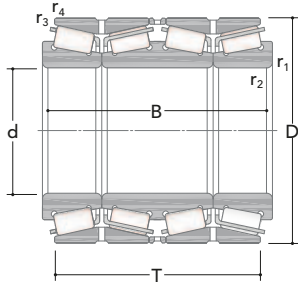

TQI

Main dimensions				Basic load ratings		Fatigue	Designation
d	D	T	B	Dynamic C	Static C ₀	load limit C _u	(AFBMA Part number)
[mm]				[kN]			
431,8	647,7	338,138	387,35	6637	14987	1161	TQI 332590
17	25,5	13,313	15,25				
(cont.)							
447,675	635	446,088	496,888	8272	21982	1601	TQI 328922
17,625	25	17,563	19,563				
450	595	352	390	5518	16126	1233	TQI 334147
17,717	23,425	13,858	15,354				
482,6	615,95	317,5	355,6	5058	15506	1105	TQI 328268
19	24,25	12,5	14				(272249/210)
510	655	362	405	6272	19211	1355	TQI 328732

Dimensions			Factor	Mass	Designation
d	r _{1,2min}	r _{3,4min}	e		(AFBMA Part number)
[mm]				[kg]	
431,8 17	6,4	1,5	0,33	420,00	TQI 332590
(cont.)					
447,675 17,625	6,4	1,5	0,33	475,00	TQI 328922
450 17,717	6	1,5	0,33	295	TQI 334147
482,6 19	6,4	1,5	0,33	245,00	TQI 328268 (272249/210)
510	6,4	1,5	0,33	330	TQI 328732

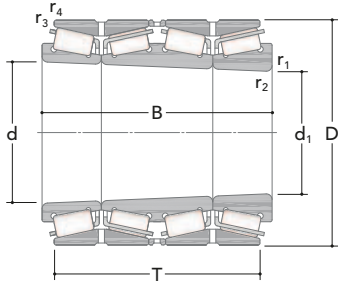

TQIT

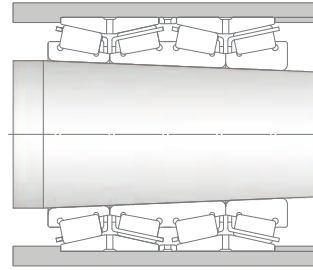

Main dimensions					Basic load ratings		Fatigue load limit	Designation
d	d1	D	T	B	Dynamic C	Static C ₀	C _u	(AFBMA Part number)
[mm]					[kN]			
170,655	156,634	225,425	152,4	168,275	860	2228	205	TQIT 332646
6,719	6,167	8,875	6	6,625				
200,82	180,843	284,162	219,075	239,715	1801	4140	391	TQIT 332800
7,906	7,120	11,188	8,625	9,438				(240631/644/647/611)
258,762	234,422	358,775	257,175	292,1	2881	7125	618	TQIT 332961
10,188	9,229	14,125	10,125	11,5				(249730/747/749/710)
271,462	246,327	381	269,875	301,625	4091	8080	703	TQIT 332719
10,688	9,694	15	10,625	11,875				(252330/345/349/310)
287,5	259,975	440	284	330,3	4196	8396	744	TQIT 332997
11,319	10,235	17,323	11,181	13,004				
289,833	263,333	407	288	375	3532	9015	764	TQIT 328315
11,411	10,367	16,024	11,339	14,764				
317,5	294,481	438,15	276,225	276,225	3519	8213	702	TQOT 328952
12,5	11,594	17,25	10,875	10,875				
320	295,833	422,275	261,424	290	3052	8140	681	TQIT 332716
12,598	11,647	16,625	10,292	11,417				(258630/646/649/610)
		422,275	261,424	336	3052	8140	681	TQITE 328344
		16,625	15,292	13,228				(258630/646/649/610)
		422,275	261,424	336	3052	8140	681	TQITE 332962
		16,625	10,292	13,228				
323,85	293,952	447,675	323,85	414,338	4390	10702	888	TQIT 332668
12,75	11,573	17,625	12,75	16,313				
345,281	315,383	488,95	358,775	358,775	4885	12607	1011	TQOT 334074
13,594	12,417	19,25	14,125	14,125				

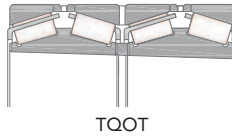
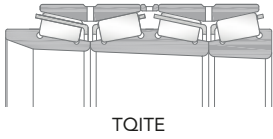

Dimensions			Factor	Mass	Designation
d	r _{1,2min}	r _{3,4min}	e		(AFBMA Part number)
[mm]				[kg]	
170,655 6,719	3,5	0,8	0,37	20,5	TQIT 332646
200,82 7,906	3	1,5	0,33	50,5	TQIT 332800 (240631/644/647/611)
258,762 10,188	3,3	1,5	0,33	100	TQIT 332961 (249730/747/749/710)
271,462 10,688	6,4	1,5	0,33	80	TQIT 332719 (252330/345/349/310)
287,5 11,319	4	1	0,35	180	TQIT 332997
289,833 11,411	3,5	1,5	0,37	125	TQIT 328315
317,5 12,5	1,5	3,3	0,43	135	TQOT 328952
320 12,598	6,5	1,5	0,31	120	TQIT 332716 (258630/646/649/610)
	6	1,5	0,31	125	TQITE 328344 (258630/646/649610)
	6,5	1,5	0,31	125	TQITE 332962
323,85 12,75	6	1,5	0,33	200	TQIT 332668
345,281 13,594	3,3	3,3	0,33	240	TQOT 334074

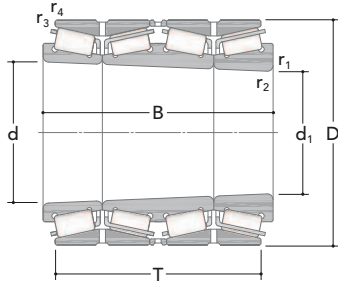

TQIT

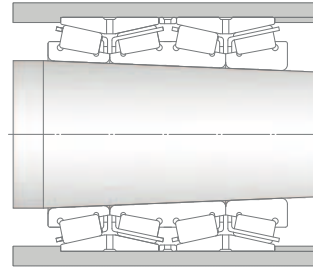

Main dimensions					Basic load ratings		Fatigue load limit	Designation
d	d1	D	T	B	Dynamic C	Static C ₀	C _u	(AFBMA Part number)
[mm]					[kN]			
352,425	320,411	488,95	342,9	384,175	3763	10157	834	TQIT 332654
13,875	12,615	19,25	13,5	15,125				(262730/746/749/710)
384,175	350,838	546,1	400,05	400,05	6482	16525	1296	TQOT 334128
15,125	13,813	21,5	15,75	15,75				
390,525	354,805	546,1	384,175	428,625	6482	16525	1296	TQIT 332664
15,375	13,969	21,5	15,125	16,875				(266430/446/449/410)
391,071	355,352	550	384,175	428,625	6482	16525	1296	TQIT 328305
15,397	13,990	21,654	15,125	16,875				(266432/445/448/413)
419,1	379,941	590,55	419,1	469,9	7157	19329	1458	TQIT 328203
16,5	14,958	23,25	16,5	18,5				(268729/745/747/710)
		590,64	419,1	469,9	7157	19329	1458	TQIT 328564
		23,254	16,5	18,5				(268729/745/747/710)
453,39	411,982	635	446,088	496,888	8258	22000	1600	TQIT 332822
17,85	16,220	25	17,563	19,563				(270730/746/749/710)
479,425	438,15	679,45	495,3	495,3	9043	24758	1742	TQOT 334057
18,875	17,25	26,75	19,5	19,5				
488,95	444,5	679,45	479,425	533,4	9278	25686	1817	TQIT 332760
19,25	17,5	26,75	18,875	21				(272730/746/749/710)
515	480	700	420	420	7987	21702	1553	TQOT 328965
20,276	18,898	27,559	16,535	16,535				
		700	370	420	7425	19568	1462	TQIT 334097
		27,559	14,567	16,535				
530,225	481,937	736,6	519,112	579,438	11312	30616	2187	TQIT 332933
20,875	18,974	29	20,438	22,813				(275330/346/349/310)

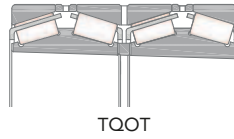
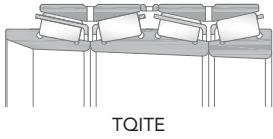

Dimensions			Factor	Mass	Designation
d	r _{1,2min}	r _{3,4min}	e		(AFBMA Part number)
[mm]				[kg]	
352,425 13,875	6,4	1,5	0,33	205	TQIT 332654 (262730/746/749/710)
384,175 15,125	3,3	3,3	0,33	340	TQOT 334128
390,525 15,375	6,4	1,5	0,33	340	TQIT 332664 (266430/446/449/410)
391,071 15,397	6,4	1,5	0,33	345	TQIT 328305 (266432/445/448/413)
419,1 16,5	6,4	1,5	0,33	440	TQIT 328203 (268729/745/747/710)
	6,4	1,5	0,33	440	TQIT 328564 (268729/7457/747/710)
453,39 17,85	6,4	1,5	0,33	600	TQIT 332822 (270730/746/749/710)
479,425 18,875	3,3	6,4	0,33	645	TQOT 334057
488,95 19,25	12,7	1,5	0,33	640	TQIT 332760 (272730/746/749/710)
515 20,276	3	6	0,43	515	TQOT 328965
	6	2,5	0,35	490	TQIT 334097
530,225 20,875	6,4	1,5	0,33	865	TQIT 332933 (275330/346/349/310)

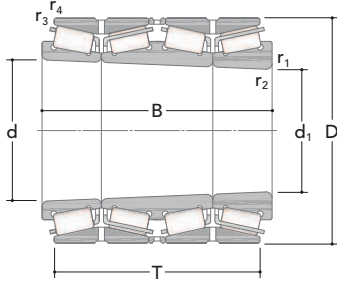

TQIT

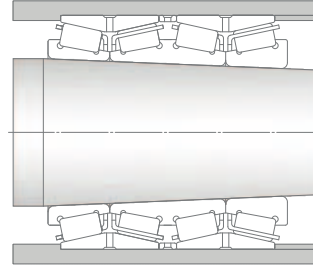

Main dimensions					Basic load ratings		Fatigue load limit	Designation
d	d1	D	T	B	Dynamic C	Static C ₀	C _u	(AFBMA Part number)
[mm]					[kN]			
547,688	497,683	761,873	536,575	600,075	11672	32092	2194	TQIT 332659
21,563	19,594	29,995	21,125	23,625				(276430/446/449/410)
555,233	497,556	761,873	536,575	692,15	11672	32092	2194	TQITE 334125
21,860	19,589	29,995	21,125	27,25				(276431/445/447410)
571,5	522,023	812,8	593,725	593,725	13266	35899	2407	TQOT 332666
22,5	20,552	32	23,375	23,375				
581,025	527,579	812,8	571,5	641,35	11984	31963	2163	TQIT 332658
22,875	20,771	32	22,5	25,25				
604,838	569,78	787,4	369,888	420,688	8482	23539	1636	TQIT 328045
23,813	22,432	31	14,563	16,563				
644,525	595,313	857,25	523,875	590,55	12082	36119	2425	TQIT 332934
25,375	23,438	33,75	20,625	23,25				(281030/043/047/010)
669,925	621,667	933,45	649,288	725,488	17311	49070	3146	TQIT 332928
26,375	24,475	36,75	25,563	28,563				(281630/646/649/610)
680	621,667	930	700	700	18393	54489	3369	TQOT 328349
26,772	24,475	36,614	27,559	27,559				
682,625	624,152	965,2	701,675	701,675	17385	49629	3061	TQOT 328558
26,875	24,573	38	27,625	27,625				
744,538	676,806	1035,05	727,075	812,8	20665	57755	3646	TQIT 332943
29,313	26,646	40,75	28,625	32				(283430/446/449/410)
749,3	676,806	990,6	577	650	15164	44873	2890	TQIT 332596
29,5	26,646	39	22,717	25,591				

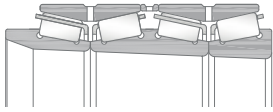

TQITE

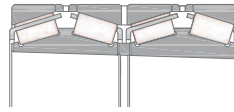

TQOT

Dimensions			Factor	Mass	Designation
d	r _{1,2min}	r _{3,4min}	e		(AFBMA Part number)
[mm]				[kg]	
547,688 21,563	6,4	1,5	0,33	930	TQIT 332659 (276430/446/449/410)
555,233 21,860	6,4	1,5	0,33	990	TQITE 334125 (276431/445/447/410)
571,5 22,5	3,3	6,4	0,33	1105	TQOT 332666
581,025 22,875	6,4	1,5	0,33	1100	TQIT 332658
604,838 23,813	6,4	1,5	0,33	580	TQIT 328045
644,525 25,375	6,4	1,5	0,33	1030	TQIT 332934 (281030/043/047/010)
669,925 26,375	6,4	1,5	0,33	1700	TQIT 332928 (281630/646/649/610)
680 26,772	3	6	0,31	1625	TQOT 328349
682,625 26,875	3,3	6,4	0,33	1825	TQOT 328558
744,538 29,313	9,7	1,5	0,33	2350	TQIT 332943 (283430/446/449/410)
749,3 29,5	6,4	3,3	0,33	1500	TQIT 332596

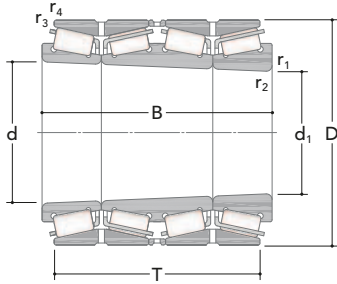

TQIT

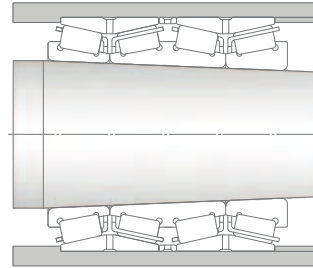

Main dimensions					Basic load ratings		Fatigue load limit	Designation
d	d1	D	T	B	Dynamic C	Static C ₀	C _u	(AFBMA Part number)
[mm]					[kN]			
770	709,167	1040	650	800	18476	52644	3272	TQITE 334099
30,315	27,92	40,945	25,591	31,496				
777,672	707,294	1079,5	755,65	844,55	22078	63067	3796	TQIT 332959
30,617	27,846	42,5	29,75	33,25				(284229/244/248/210)
777,875	707,457	1079,5	755,65	844,55	22078	63067	3796	TQIT 332956
30,625	27,854	42,5	29,75	33,25				(284230/246/249/210)
825,5	755,121	1168,4	844,6	844,6	23514	76684	4389	TQOT 334040
32,5	29,729	46	33,25	33,25				
828,675	759,883	1143	733,425	825,5	22426	65099	3924	TQIT 332663
32,625	29,917	45	28,875	32,5				
863,6	803,853	1130,3	644,525	717,55	19867	62050	3747	TQIT 332571
34	31,624	44,5	25,375	28,25				
	807,773	1130,3	669,925	669,925	19867	62050	3747	TQOT 328857
	31,802	44,5	26,375	26,375				
872,769	813,239	1179,805	628,65	793,75	20937	57036	3548	TQITE 332960
34,361	32,017	46,449	24,75	31,25				(286433/443/447/412)
	1181,1	628,65	714,375	20937	57036	3548		TQIT 332786
	46,5	24,75	28,125					(286433/443/447/410)
872,847	813,466	1181,1	628,65	714,375	20937	57036	3548	TQIT 328956
34,364	32,026	46,5	24,75	28,125				(286432/446/449/410)
879,475	801,688	1219,2	838,2	933,45	27924	80980	4781	TQIT 328074
34,625	31,563	48	33	36,75				
889	815,667	1219,2	784,225	880	27349	78709	4509	TQIT 332602
35	32,113	48	30,875	34,646				

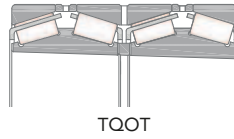
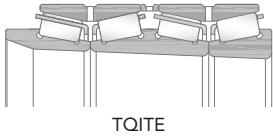

Dimensions			Factor	Mass	Designation
d	r _{1,2min}	r _{3,4min}	e		(AFBMA Part number)
[mm]				[kg]	
770 30,315	3	3	0,3	2015	TQITE 334099
777,672 30,617	9,7	3,3	0,33	2650	TQIT 332959 (284229/244/248/210)
777,875 30,625	9,7	3,3	0,33	2650	TQIT 332956 (284230/246/249/210)
825,5 32,5	4,8	12,7	0,33	2800	TQOT 334040
828,675 32,625	9,7	3,3	0,33	2475	TQIT 332663
863,6 34	9,7	3,3	0,33	2100	TQIT 332571
	4,8	12,7	0,33	2000	TQOT 328857
872,769 34,361	9,7	3,3	0,33	2530	TQITE 332960 (286433/443/447/412)
	9,7	3,3	0,33	2450	TQIT 332786 (286433/443/447/410)
872,847 34,364	9,7	3,3	0,33	2450	TQIT 328956 (286432/446/449/410)
879,475 34,625	12,7	3,3	0,33	3680	TQIT 328074
889 35	9,7	3,3	0,33	3340	TQIT 332602

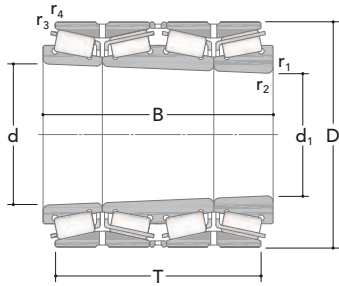

TQIT

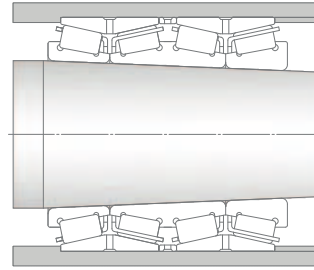

Main dimensions					Basic load ratings		Fatigue load limit	Designation
d	d1	D	T	B	Dynamic C	Static C ₀	C _u	(AFBMA Part number)
[mm]					[kN]			
896,903	833,07	1264	680	766	23240	64650	3762	TQIT 334081
35,311	32,798	49,764	26,772	30,158				
1004,634	936,901	1308,1	730,25	812,8	24955	77149	4363	TQIT 332720
39,553	36,886	51,5	28,75	32				(288130/146/149/110)

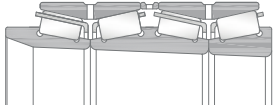

TQITE

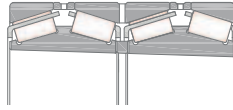

TQOT

Dimensions			Factor	Mass	Designation
d	r _{1,2min}	r _{3,4min}	e		(AFBMA Part number)
[mm]				[kg]	
896,903 35,311	12,7	3,3	0,37	3100	TQIT 334081
1004,634 39,553	12,7	3,3	0,33	3060	TQIT 332720 (288130/146/149/110)

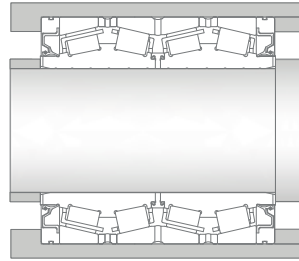
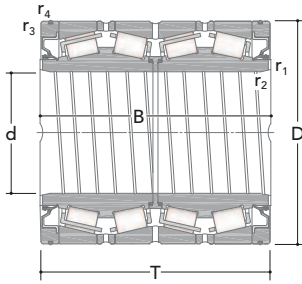

TQOS₁

Main dimensions				Basic load ratings		Fatigue load limit	Designation
d	D	T	B	Dynamic C	Static C ₀	C _u	
[mm]				[kN]			
152,4	244,475	187,325	192,088	1306	2140	224	TQOS 329121
6	9,625	7,375	7,563				
203,2	317,5	266,7	266,7	2440	4846	476	TQOS 329123
8	12,5	10,5	10,5				
206,375	282,575	226	226	1284	3393	307	TQOS 329090
8,125	11,125	8,898	8,898				
220	295	315	315	1869	4007	360	TQOS 328853
8,661	11,614	12,402	12,402				
220,662	314,325	239,712	239,712	1789	3805	355	TQOS 328546
8,688	12,375	9,438	9,438				
228,6	400,05	296,875	296,875	3386	5637	515	TQOS 328918
9	15,75	11,688	11,688				
240	338	340	340	2403	5441	486	TQOS 328854
9,449	13,307	13,386	13,386				
241,478	349,148	228,6	228,6	1912	3676	336	TQOS 328668
9,507	13,746	9	9				
254	358,775	269,875	269,875	2443	5776	505	TQOS 329071
10	14,125	10,625	10,625				
260	365	340	340	3165	7940	675	TQOS 329093
10,236	14,370	13,386	13,386				
266,7	355,6	228,6	230,188	1708	4171	361	TQOS 328468
10,5	14	9	9,063				

⁽¹⁾ Bearing with inner ring extended at both sides

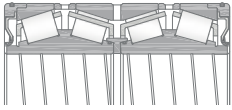

TQOS2

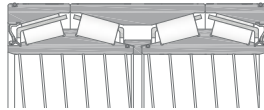

TQOS3

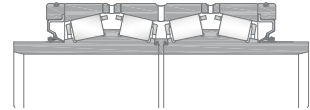

TQOES

Dimensions			Factor	Mass	Designation
d	r _{1,2min}	r _{3,4min}	e		
[mm]				[kg]	
152,4 6	1	3,3	0,33	30,00	TQOS 329121
203,2 8	2,5	3,3	0,31	76	TQOS 329123
206,375 8,125	0,6	3,3	0,5	40	TQOS 329090
220 8,661	0,6	2,5	0,4	55	TQOS 328853
220,662 8,688	1,5	3,3	0,35	56,00	TQOS 328546
228,6 9	2,5	3,3	0,44	148,00	TQOS 328918
240 9,449	1,5	4	0,4	88	TQOS 328854
241,478 9,507	1,5	3,3	0,35	64,00	TQOS 328668
254 10	1,5	3,3	0,33	84	TQOS 329071
260 10,236	2,5	3,5	0,35	112,00	TQOS 329093
266,7 10,5	1,5	3,3	0,35	68	TQOS 328468

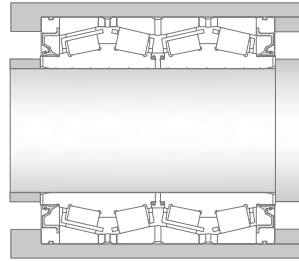
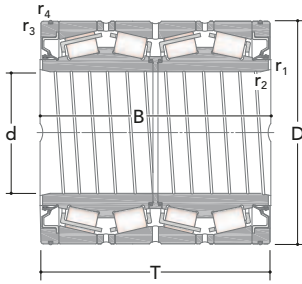

TQOS₁

Main dimensions				Basic load ratings		Fatigue load limit	Designation
d	D	T	B	Dynamic C	Static C ₀	C _u	
[mm]				[kN]			
266,7	355,6	228,6	230,188	1877	4658	412	TQOS 328916
10,5	14	9	9,063				
(cont.)							
276,225	393,7	269,875	269,875	2709	5819	524	TQOS 328920
10,875	15,5	10,625	10,625				
	393,7	269,875	269,875	2662	5454	489	TQOS 328554
	15,5	10,625	10,625				
279,4	393,7	269,875	269,875	2726	5767	538	TQOS 328917
11	15,5	10,625	10,625				
280	395	340	340	3585	8590	745	TQOS 329092
11,024	15,551	13,386	13,386				
285,75	380,898	244,475	244,475	2185	5493	476	TQOS 328878
11,25	14,996	9,625	9,625				
300	440	279,4	280,99	3082	6725	583	TQOS 334126
11,811	17,323	11	11,063				
304,648	438,048	279,4	280,99	3082	6725	583	TQOS 334008
11,994	17,246	11	11,063				
304,8	419,1	269,875	269,875	2821	6881	593	TQOS 329067
12	16,5	10,625	10,625				
	501,65	336,55	336,55	4740	9214	771	TQOS 328909
	19,75	13,25	13,25				
304,902	412,648	266,7	266,7	2478	6115	519	TQOS 328278
12,004	16,246	10,5	10,5				
	412,648	266,7	266,7	2726	6773	573	TQOS 328945
	16,246	10,5	10,5				

⁽¹⁾ Bearing with inner ring extended at both sides

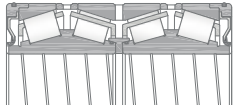

TQOS2

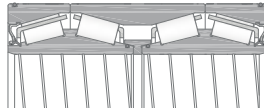

TQOS3

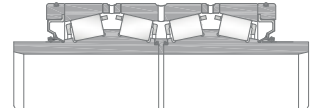

TQOES

Dimensions			Factor	Mass	Designation
d	r _{1,2min}	r _{3,4min}	e		
[mm]				[kg]	
266,7	1,5	3,3	0,35	60,00	TQOS 328916
10,5					
(cont.)					
276,225	1	6,4	0,37	96,00	TQOS 328920
10,875					
	1	6,4	0,4	96,00	TQOS 328554
279,4	1	6,4	0,37	96,00	TQOS 328917
11					
280	2,5	3,5	0,33	128,00	TQOS 329092
11,024					
285,75	1	3,3	0,43	74,00	TQOS 328878
11,25					
300	3,3	4,8	0,46	137,00	TQOS 334126
11,811					
304,648	2	4,8	0,46	129,00	TQOS 334008
11,994					
304,8	1	6,4	0,35	108,00	TQOS 329067
12					
	2	6,4	0,4	254,00	TQOS 328909
304,902	1	3,3	0,33	98,00	TQOS 328278
12,004					
	1	3,3	0,31	100,00	TQOS 328945

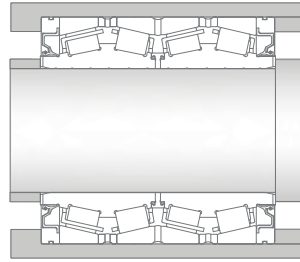
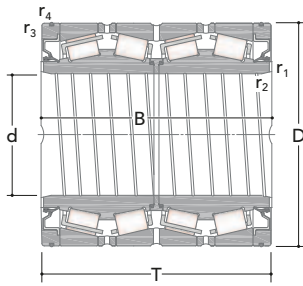

TQOS₁

Main dimensions				Basic load ratings		Fatigue load limit	Designation
d	D	T	B	Dynamic C	Static C ₀	C _u	
[mm]				[kN]			
305	438,048	279,4	280,99	3113	6648	589	TQOS 334076
12,008	17,246	11	11,059				
317,5	422,275	269,875	269,875	2834	6521	569	TQOS 334023
12,5	16,625	10,625	10,625				
333,375	469,9	342,9	342,9	4150	10164	834	TQOS 328921
13,125	18,5	13,5	13,5				
343,052	457,098	254	254	2620	6449	537	TQOS 328817
13,506	17,996	10	10				
	457,098	254	254	2532	6065	536	TQOS 334033
	17,996	10	10				
	457,098	254	254	2343	6026	505	TQOS 334106
	17,996	10	10				
	457,098	254	323,85	2709	6425	533	TQOS 328986 ⁽¹⁾
	17,996	10	12,75				
355,6	482,6	269,875	265,112	3071	7496	622	TQOS 328870
14	19	10,625	10,438				
	488,95	317,5	317,5	4107	9901	840	TQOS 328912
	19,25	12,5	12,5				
385,762	514,35	317,5	317,5	3882	10049	776	TQOS 334042
15,188	20,25	12,5	12,5				
406,4	546,1	288,925	288,925	3930	9415	759	TQOS 328838
16	21,5	11,375	11,375				
	546,1	330	330	4005	10305	809	TQOS 334093
	21,5	12,992	12,992				
409,575	546,1	334,962	334,962	4874	11880	929	TQOS 329004
16,125	21,5	13,188	13,188				

⁽¹⁾ Bearing with inner ring extended at both sides

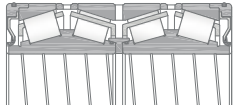

TQOS2

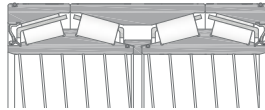

TQOS3

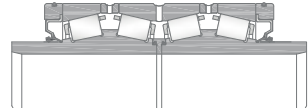

TQOES

Dimensions			Factor	Mass	Designation
d	r _{1,2min}	r _{3,4min}	e		
[mm]				[kg]	
305 12,008	2	4,8	0,46	129	TQOS 334076
317,5 12,5	1,5	3,3	0,33	98,00	TQOS 334023
333,375 13,125	2,5	3,3	0,33	182,00	TQOS 328921
343,052 13,506	1	3,3	0,48	109,00	TQOS 328817
	1	3,3	0,54	109	TQOS 334033
	1	3,3	0,68	109,00	TQOS 334106
	1	3,3	0,48	120,00	TQOS 328986 ⁽¹⁾
355,6 14	1,5	3,3	0,46	136,00	TQOS 328870
	1	3,3	0,33	172,00	TQOS 328912
385,762 15,188	1	3,3	0,4	174,00	TQOS 334042
406,4 16	1,5	6,4	0,48	183,00	TQOS 328838
	1,5	6,4	0,48	202	TQOS 334093
409,575 16,125	1	6,4	0,4	210,00	TQOS 329004

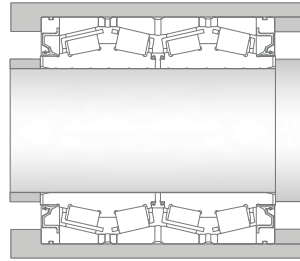
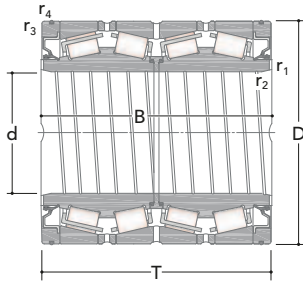

TQOS₁

Main dimensions				Basic load ratings		Fatigue load limit	Designation
d	D	T	B	Dynamic C	Static C ₀	C _u	
[mm]				[kN]			
415,925	590,55	434,975	434,975	6939	18238	1374	TQOS 328893
16,375	23,25	17,125	17,125				
416	574	440	440	6128	16830	1259	TQOS 334130
16,378	22,598	17,323	17,323				
430	575	380	380	5233	14123	1087	TQOS 334095
16,929	22,638	14,961	14,961				
440	590	480	480	7111	19204	1460	TQOS 334055
17,323	23,228	18,898	18,898				
	650	353,5	353,5	6696	13284	1017	TQOS 328944
	25,591	13,917	13,917				
450	595	398	398	5483	16079	1219	TQOS 328846
17,717	23,425	15,669	15,669				
457,2	596,9	279,4	276,225	3956	10016	780	TQOS 328827
18	23,5	11	10,875				
460	610	360	360	5044	12873	1029	TQOS 328727
18,110	24,016	14,173	14,173				
475	600	368	368	4683	13971	1029	TQOS 334078
18,701	23,622	14,488	14,488				
479,425	679,45	495,3	495,3	8513	22165	1661	TQOS 334116
18,875	26,75	19,5	19,5				
482,6	615,95	330,2	330,2	6049	13679	1062	TQOS 328842
19	24,25	13	13				
	615,95	330,2	406,4	6049	13679	1062	TQOS 328887 ⁽¹⁾
	24,25	13	16				

⁽¹⁾ Bearing with inner ring extended at both sides

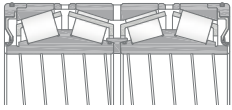

TQOS2

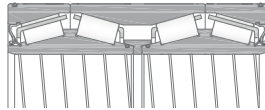

TQOS3

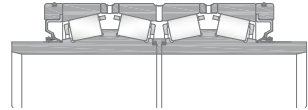

TQOES

Dimensions			Factor	Mass	Designation
d	r _{1,2min}	r _{3,4min}	e		
[mm]				[kg]	
415,925 16,375	3,3	6,4	0,33	379	TQOS 328893
416 16,378	2,5	5	0,33	341,00	TQOS 334130
430 16,929	1,5	5	0,33	267,00	TQOS 334095
440 17,323	1	5	0,28	371,00	TQOS 334055
	5,5	6,4	0,33	378,00	TQOS 328944
450 17,717	2	6	0,33	301	TQOS 328846
457,2 18	1,5	3,3	0,48	191	TQOS 328827
460 18,110	3	6	0,37	270	TQOS 328727
475 18,701	2	6	0,33	235	TQOS 334078
479,425 18,875	3,3	6,4	0,33	565	TQOS 334116
482,6 19	1	6,4	0,33	232	TQOS 328842
	1	6,4	0,33	250	TQOS 328887 ⁽¹⁾

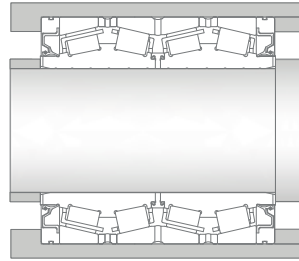
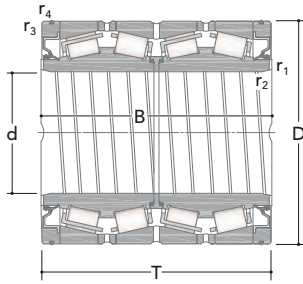

TQOS₁

Main dimensions				Basic load ratings		Fatigue load limit	Designation
d	D	T	B	Dynamic C	Static C ₀	C _u	
[mm]				[kN]			
482,6	615,95	330,2	406,4	4415	12360	922	TQOS 328223 ⁽¹⁾
19	24,25	13	16				
(cont.)	615,95	330,2	419,1	6049	13679	1062	TQOS 334072 ⁽¹⁾
	24,25	13	16,5				
	615,95	402,05	402,05	5566	17304	1296	TQOS 328974
	24,25	15,847	15,847				
	630	420	420	5925	16946	1287	TQOS 328930
	24,803	16,535	16,535				
489,026	634,873	320,675	320,675	4787	12415	946	TQOS 334014
19,253	24,995	12,625	12,625				
	634,873	320,675	320,675	4041	11359	853	TQOS 334115
	24,995	12,625	12,625				
510	655	379	377	5744	16471	1185	TQOS 334022
20,079	25,787	14,922	14,843				
540	690	434	434	6954	20902	1498	TQOS 334028
21,260	27,165	17,087	17,087				
558,8	736,6	322,262	322,262	5813	14357	1072	TQOS 328864
22	29	12,688	12,688				
	736,6	409,575	409,575	6556	19911	1439	TQOS 334080
	29	16,125	16,125				
	736,6	457,2	455,612	7909	23404	1621	TQOS 334136
	29	18	17,938				
571,5	812,8	593,725	593,725	12043	33133	2247	TQOS 334144
22,5	32	23,375	23,375				
585,788	771,525	479,425	479,425	9550	27413	1870	TQOS 328888
23,063	30,375	18,875	18,875				

⁽¹⁾ Bearing with inner ring extended at both sides

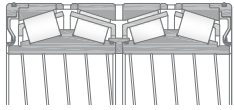

TQOS₂

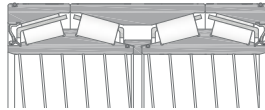

TQOS₃

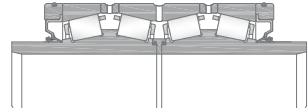

TQOES

Dimensions			Factor	Mass	Designation
d	r _{1,2min}	r _{3,4min}	e		
[mm]				[kg]	
482,6	1	6,4	0,33	237,00	TQOS 328223 ⁽¹⁾
19					
(cont.)	1	6,4	0,33	243,00	TQOS 334072 ⁽¹⁾
	1	6,4	0,33	290,00	TQOS 328974
	3,3	6,4	0,33	325	TQOS 328930
489,026	1	3,3	0,37	248	TQOS 334014
19,253	1	3,3	0,68	247,00	TQOS 334115
510	1,5	6,4	0,35	311,00	TQOS 334022
20,079					
540	2	5	0,33	392,00	TQOS 334028
21,260					
558,8	1,5	6,4	0,35	343,00	TQOS 328864
22	3,3	6,4	0,48	475,00	TQOS 334080
	3,3	6,4	0,35	515,00	TQOS 334136
571,5	3,3	6,4	0,33	998,00	TQOS 334144
22,5					
585,788	4	6,4	0,33	596,00	TQOS 328888
23,063					

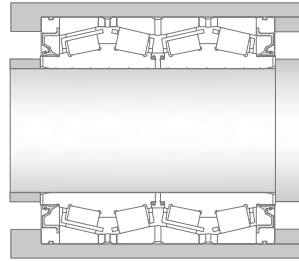
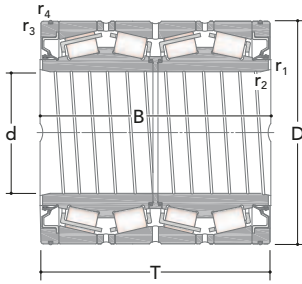

TQOS₁

Main dimensions				Basic load ratings		Fatigue load limit	Designation
d	D	T	B	Dynamic C	Static C ₀	C _u	
[mm]				[kN]			
609,6	787,4	361,95	361,95	6880	18334	1385	TQOS 328871
24	31	14,25	14,25	9727	27890	1877	TQOS 334108
	813,562	479,425	479,425				
	32,03	18,875	18,875				
635	901,7	654,05	654,05	14342	41134	2677	TQOS 334141
25	35,5	25,75	25,75				
660	855	318,48	400,842	6331	17304	1208	TQOS 334002 ⁽¹⁾
25,984	33,661	12,539	15,781				
660,4	812,8	365,125	385,424	6567	20244	1440	TQOS 328977 ⁽¹⁾
26	32	14,375	15,175				
679,45	901,7	552,45	552,45	12027	36063	2396	TQOS 334015
26,75	35,5	21,75	21,75	12027	36063	2396	TQOS 334016 ⁽¹⁾
	901,7	552,45	635				
	35,5	21,75	25				
682,625	965,2	701,675	701,675	17288	49371	3101	TQOS 334060
26,875	38	27,625	27,625				
685,8	876,3	355,6	352,425	7177	20093	1397	TQOS 328955
27	34,5	14	13,875				
710	900	410	410	8246	24199	1638	TQOS 334051
27,953	35,433	16,142	16,142				
711,2	914,4	317,5	317,5	6555	17538	1198	TQOS 329010
28	36	12,5	125000	6947	19090	1349	TQOS 328988 ⁽¹⁾
	914,4	387,35	425,45				
	36	15,25	16,75				

⁽¹⁾ Bearing with inner ring extended at both sides

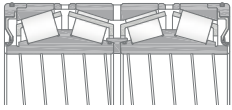

TQOS₂

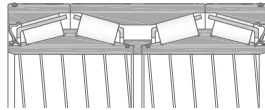

TQOS₃

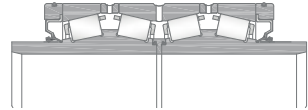

TQOES

Dimensions			Factor	Mass	Designation
d	r _{1,2min}	r _{3,4min}	e		
[mm]				[kg]	
609,6	3,3	6,4	0,37	430	TQOS 328871
24	3,3	6,4	0,37	693,00	TQOS 334108
635	3,3	6,4	0,35	1354	TQOS 334141
25					
660	4	5	0,35	488,00	TQOS 334002 ⁽¹⁾
25,984					
660,4	2	6,4	0,33	396,00	TQOS 328977 ⁽¹⁾
26					
679,45	3,3	6,4	0,33	975,00	TQOS 334015
26,75	3,3	6,4	0,33	1030	TQOS 334016 ⁽¹⁾
682,625	3,3	6,4	0,35	651	TQOS 334060
26,875					
685,8	3,3	6,4	0,37	506	TQOS 328955
27					
710	3	6	0,33	602,00	TQOS 334051
27,953					
711,2	2,5	6,4	0,37	490,00	TQOS 329010
28	5,5	3,3	0,37	602	TQOS 328988 ⁽¹⁾

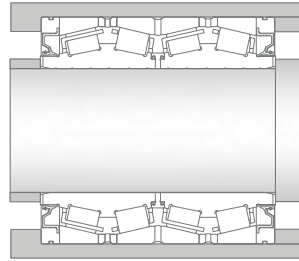
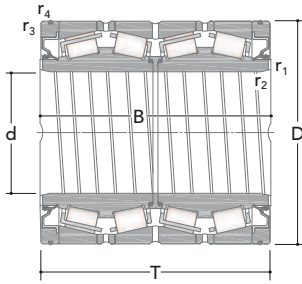

TQOS₁

Main dimensions				Basic load ratings		Fatigue load limit	Designation
d	D	T	B	Dynamic C	Static C ₀	C _u	
[mm]				[kN]			
749,3	990,6	605	605	13083	40849	2565	TQOS 334082
29,5	39	23,819	23,819				
762	1079,5	787,4	787,4	21062	61002	3701	TQOS 334075
30	42,5	31	31				
825,5	1168,4	844,55	844,55	24725	73100	4349	TQOS 334135
32,5	46	33,25	33,25				
863,6	1169,987	844,55	844,55	23214	70966	4079	TQOS 334150
34	46,063	33,25	33,25				

⁽¹⁾ Bearing with inner ring extended at both sides

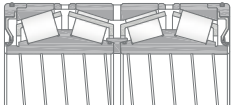

TQOS₂

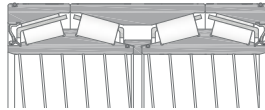

TQOS₃

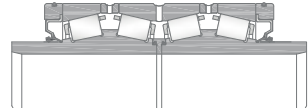

TQOES

Dimensions			Factor	Mass	Designation
d	r _{1,2min}	r _{3,4min}	e		
[mm]				[kg]	
749,3 29,5	3,3	6,4	0,37	1274	TQOS 334082
762 30	4,8	12,7	0,35	2248,00	TQOS 334075
825,5 32,5	4,8	12,7	0,31	2958,00	TQOS 334135
863,6 34	4,8	12,7	0,37	2630,00	TQOS 334150



Spherical roller bearings

Spherical roller bearings	472
SRB: a complete range.....	472
Tailor made solutions.....	472
Internal clearance.....	472
Misalignment.....	475
Minimum load	475
Internal clearance and axial drive-up for spherical roller bearings with tapered bore	475
Mounting procedures for bearing with tapered bore.....	477
Designs and variants	478
Type CA/CAF	478
Type MA	478
Type ECA.....	478
Type MB	478
Type CC.....	479
Special designs and variants.....	479
Sealed type	479
Type WOR	479
Type ECCS	479
Split type SSRB	480
Type ROVSX/KROVSX.....	480
Suffixes.....	481
Prefixes.....	482
Product tables.....	484

Spherical roller bearings

The spherical roller bearings (SRBs) manufactured by RKB are engineered to withstand high radial forces and moderate axial forces acting in both directions. RKB SRBs can dynamically accommodate misalignments due to shaft bending. They are produced with cylindrical or tapered bore, in open or sealed execution. Depending on application requirements, RKB Bainite Hardening Treatment (HB) and High Temperature Dimensional Stabilization (S) can be applied on bearing rings and rollers. Moreover, as for dimensions, RKB spherical roller bearings are manufactured according to ISO/ABMA/GOST specifications. As a consequence, they are fully interchangeable with all the bearings that meet the relevant international standards.



Spherical roller bearings

SRB: a complete range

The range of RKB spherical roller bearings covers most requirements of standard and special industrial applications, in severe and critical working conditions. RKB offers a wide portfolio of open and sealed SRBs in all diameter and width series. While the narrow low-section bearings (e.g. 238 series) feature

high speed capabilities as well as low weight and minimum space dimensions, the wide high-section bearings (e.g. 233 series) have higher load carrying capacities. All RKB SRBs put together experience in design with proven performance in all major industries.

Tailor made solutions

Besides the main spherical roller bearing designs, RKB has developed new solutions according to specific application requirements. The special designs include SEALED SRBs, for smooth operation in contaminated environments, ROVSX type, expressly designed for vibratory equipment, WOR execution, suitable for gear output shaft of truck concrete mixers, and SPLIT bearings to make maintenance operations easier at hard-to-reach positions. If duly applied, these special designs are cost effective for the customer, since they allow increased bearing life expectancy and reduced machine downtime.

Internal clearance

Spherical roller bearings are produced as standard with Normal radial internal clearance CN, but they are also available with C2, C3, C4 and C5 radial internal clearance, in accordance with the ISO 5753:2009.

Spherical roller bearings for vibratory applications are produced as standard with C4 radial clearance.

The radial internal clearances are reported for bearing with:

- cylindrical bore in the **Tab. 1 page 473**;
- tapered bore in the **Tab. 2 page 474**;

and they are valid only for bearing unmounted and unloaded.

d [mm]		Radial internal clearance [µm]							
		C2		CN		C3		C4	
over	incl.	min.	max.	min.	max.	min.	max.	min.	max.
14	18	10	20	20	35	35	45	45	60
18	24	10	20	20	35	35	45	45	60
24	30	15	25	25	40	40	55	55	75
30	40	15	30	30	45	45	60	60	80
40	50	20	35	35	55	55	75	75	100
50	65	20	40	40	65	65	90	90	120
65	80	30	50	50	80	80	110	110	145
80	100	35	60	60	100	100	135	135	180
100	120	40	75	75	120	120	160	160	210
120	140	50	95	95	145	145	190	190	240
140	160	60	110	110	170	170	220	220	280
160	180	65	120	120	180	180	240	240	310
180	200	70	130	130	200	200	260	260	340
200	225	80	140	140	220	220	290	290	380
225	250	90	150	150	240	240	320	320	420
250	280	100	170	170	260	260	350	350	460
280	315	110	190	190	280	280	370	370	500
315	355	120	200	200	310	310	410	410	550
355	400	130	220	220	340	340	450	450	600
400	450	140	240	240	370	370	500	500	660
450	500	140	260	260	410	410	550	550	720
500	560	150	280	280	440	440	600	600	780
560	630	170	310	310	480	480	650	650	850
630	710	190	350	350	530	530	700	700	920
710	800	210	390	390	580	580	770	770	1 010
800	900	230	430	430	650	650	860	860	1 120
900	1 000	260	480	480	710	710	930	930	1 220
1 000	1 120	290	530	530	770	770	1 050	1 050	1 430
1 120	1 250	320	580	580	840	840	1 140	1 140	1 560
1 250	1 400	350	630	630	910	910	1 240	1 240	1 700
1 400	1 600	380	700	700	1 020	1 020	1 390	1 390	1 890
1 600	1 800	420	780	780	1 140	1 140	1 550	1 550	2 090
1 800	2 000	460	860	860	1 260	1 260	1 710	1 710	2 300
2 000	2 250	500	950	950	1 400	1 400	1 900	1 900	2 540
2 250	2 500	550	1 050	1 050	1 550	1 550	2 100	2 100	2 790

Tab. 1 - Radial internal clearance of spherical roller bearings with cylindrical bore

d [mm]		Radial internal clearance [μm]							
		C2		CN		C3		C4	
over	incl.	min.	max.	min.	max.	min.	max.	min.	max.
18	24	15	25	25	35	35	45	45	60
24	30	20	30	30	40	40	55	55	75
30	40	25	35	35	50	50	65	65	85
40	50	30	45	45	60	60	80	80	100
50	65	40	55	55	75	75	95	95	120
65	80	50	70	70	95	95	120	120	150
80	100	55	80	80	110	110	140	140	180
100	120	65	100	100	135	135	170	170	220
120	140	80	120	120	160	160	200	200	260
140	160	90	130	130	180	180	230	230	300
160	180	100	140	140	200	200	260	260	340
180	200	110	160	160	220	220	290	290	370
200	225	120	180	180	250	250	320	320	410
225	250	140	200	200	270	270	350	350	450
250	280	150	220	220	300	300	390	390	490
280	315	170	240	240	330	330	430	430	540
315	355	190	270	270	360	360	470	470	590
355	400	210	300	300	400	400	520	520	650
400	450	230	330	330	440	440	570	570	720
450	500	260	370	370	490	490	630	630	790
500	560	290	410	410	540	540	680	680	870
560	630	320	460	460	600	600	760	760	980
630	710	350	510	510	670	670	850	850	1 090
710	800	390	570	570	750	750	960	960	1 220
800	900	440	640	640	840	840	1 070	1 070	1 370
900	1 000	490	710	710	930	930	1 190	1 190	1 520
1 000	1 120	540	780	780	1 020	1 020	1 300	1 300	1 650
1 120	1 250	600	860	860	1 120	1 120	1 420	1 420	1 800
1 250	1 400	660	940	940	1 220	1 220	1 550	1 550	1 960
1 400	1 600	740	1 060	1 060	1 380	1 380	1 750	1 750	2 200
1 600	1 800	820	1 180	1 180	1 540	1 540	1 950	1 950	2 500
1 800	2 000	910	1 310	1 310	1 710	1 710	2 150	2 150	2 750
2 000	2 250	1 000	1 450	1 450	1 900	1 900	2 400	2 400	3 050
2 250	2 500	1 100	1 600	1 600	2 100	2 100	2 650	2 650	3 350

Tab. 2 - Radial internal clearance of spherical roller bearings with tapered bore

Misalignment

The internal design of the spherical roller bearings can accommodate some misalignment between inner ring and outer ring without affecting negatively the bearing life. If the misalignment is constant respect the outer ring and if the condition are relatively safety ($C/P > 10$) the misalignments reported onto the table are valid, however, depending on the configuration and the working conditions, the values given on the **Tab. 3** have to be properly reduced. In presence of the sealed bearing or in application where the misalignment is not constant like:

- vibration screens where the load is rotating on the outer ring and fixed on the inner ring (eccentric masses) that generates a bending on the shaft;
- deflection - compensation rolls of paper machines where the stationary shaft is bent.

It is suggested do not exceed a few tenths of degree, since the rolling element may be affected by possible sliding movements. Consequently, due to the friction between rolling elements and raceways, an increasing of temperature will be generated.

For the sealed versions, in order to guarantee the efficiency of the seals, a permissible misalignment value of approximatively 0.5° between inner ring and outer ring has to be considered.

Bearing series	Maximum misalignment for $P < 0.1 \cdot C_r$
238	$\pm 1^\circ$
213, 222, 230, 239, 240, 248, 249	$\pm 1.5^\circ$
223, 231, 232, 233, 241	$\pm 2^\circ$

Tab. 3 - SRBs max permissible angular misalignment

Minimum load

A minimum radial load is requested for a spherical roller bearings, like for all ball and roller bearings, in order to operate correctly an adequate operation condition, especially in critical working conditions: high speed, high acceleration and sudden changes of rotating direction. In these operating conditions a skidding between rollers and raceways can be generated by the inertial forces, influencing negatively the bearing life. Minimum radial load can be estimated using the following formula:

$$\frac{F_{rm}}{C_r} > 0,015$$

Where:

- F_{rm} minimum radial load, [kN];
- C_r basic dynamic radial load, [kN].

Internal clearance and axial drive-up for spherical roller bearings with tapered bore

Specific and recommended values for radial clearance reduction and axial drive-up can be provided upon request. However, in the following tables (**Tab. 4 page 476**) is reported radial internal clearance reduction for general application, featuring solid steel shaft or hallow shaft with internal bore diameter lower than shaft diameter.

For additional information please consult the RKB application engineering services.

Bore diameter d [mm]		Radial internal clearance reduction [mm]		Minimum radial internal clearance after mounting		
				CN	C3	C4
over	incl.	min.	max.	min. [mm]	min. [mm]	min. [mm]
24	30	0,015	0,02	0,015	0,02	0,035
30	40	0,02	0,025	0,015	0,025	0,04
40	50	0,025	0,03	0,02	0,03	0,05
50	65	0,03	0,04	0,025	0,035	0,055
65	80	0,04	0,05	0,025	0,04	0,07
80	100	0,045	0,06	0,035	0,05	0,08
100	120	0,05	0,07	0,05	0,065	0,01
120	140	0,065	0,09	0,055	0,08	0,11
140	160	0,075	0,1	0,055	0,09	0,13
160	180	0,08	0,11	0,06	0,1	0,15
180	200	0,09	0,13	0,07	0,1	0,16
200	225	0,1	0,14	0,08	0,12	0,18
225	250	0,11	0,15	0,09	0,13	0,2
250	280	0,12	0,17	0,1	0,14	0,22
280	315	0,13	0,19	0,11	0,15	0,24
315	355	0,15	0,21	0,12	0,17	0,26
355	400	0,17	0,23	0,13	0,19	0,29
400	450	0,2	0,26	0,13	0,2	0,31
450	500	0,21	0,28	0,16	0,23	0,35
500	560	0,24	0,32	0,17	0,25	0,36
560	630	0,26	0,35	0,2	0,29	0,41
630	710	0,3	0,4	0,21	0,31	0,45
710	800	0,34	0,45	0,23	0,35	0,51
800	900	0,37	0,5	0,27	0,39	0,57
900	1000	0,41	0,55	0,3	0,43	0,64
1000	1120	0,45	0,6	0,32	0,48	0,7
1120	1250	0,49	0,65	0,34	0,54	0,77
1250	1400	0,55	0,72	0,36	0,59	0,84
1400	1600	0,62	0,81	0,44	0,66	0,94
1600	1800	0,69	0,93	0,48	0,73	1,02
1800	2000	0,77	1,04	0,54	0,81	1,11
2000	2250	0,85	1,15	0,6	0,95	1,55
2250	2500	0,95	1,28	0,65	1,15	1,7

Tab. 4 - Radial internal clearance reduction for SRB bearings with tapered bore

Mounting procedures for bearing with tapered bore

Spherical roller bearing with tapered bore have to be mounted always with a specific interference fit. Small and even medium size bearings may be driven up directly onto a tapered shaft using a locknut. The locknut and hookspanner are used for driving small bearings onto the tapered seat of the adapter sleeve (figure 16b). Locknuts are also a convenient solution for pressing small withdrawal sleeves into the space between bearing inner ring and shaft (figure 16c). Larger bearings with tapered bore are mounted using the hydraulic method because the fitting force is considerably large. In this case, hydraulic nuts (figure 17a) should be used in order to provide the drive-up force. The oil is pumped into the nut and the piston is pushed out with the right requisite force

for the bearing mounting. Figure 17b shows a mounting method during which a special sleeve and hydraulic pressure are used. This special sleeve is provided with holes, through which oil is pumped under pressure, in order to reach the bearing seat. The bearing is subjected to a radial expansion, and the sleeve is introduced axially by means of adjusting bolts. Feeding oil under pressure underneath the inner ring also helps the bearing mounting using hydraulic nut (figure 17a).

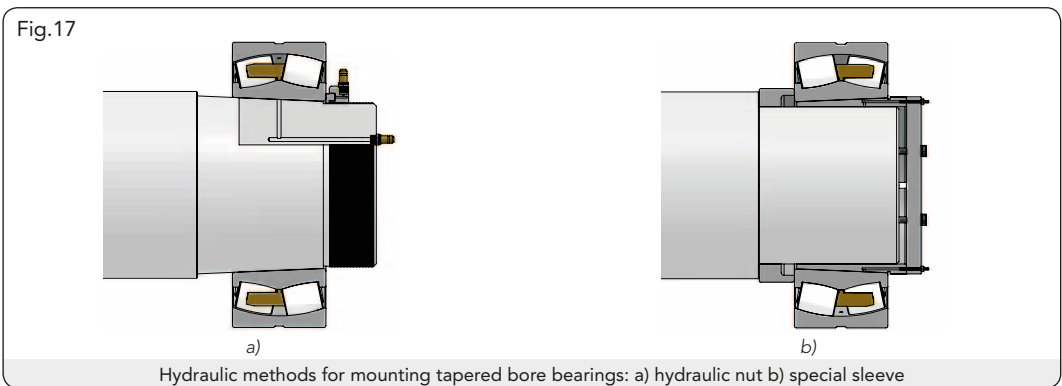
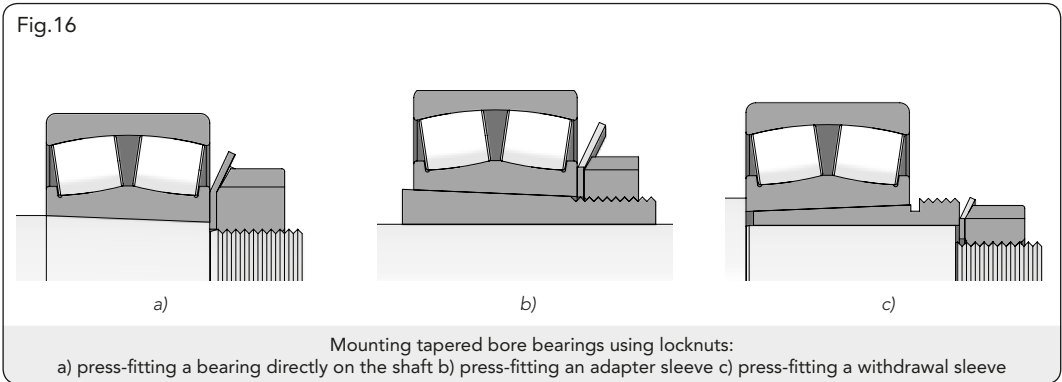

Designs and variants

Type CA/CAF

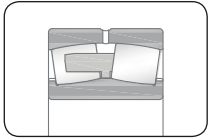

- Design used for large size bearings, withstanding high radial loads and moderate axial loads in both directions
- Inner ring with integral side ribs
- Symmetrical roller profile
- One-piece double pronged machined brass or steel (CAF) cage with integral slinger guided on the inner ring
- Lubrication groove and holes in the outer ring
- Available with lubrication groove and three lubrication holes in the outer ring and six lubrication holes in the inner ring (W513)
- Available with tapered bore (K/K30 suffixes)

Type MA

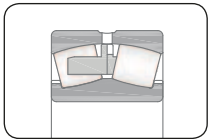

- Design used for medium and large size bearings
- Inner ring with integral side ribs
- Symmetrical roller profile
- Two-piece machined brass cage guided on the outer ring
- Lubrication groove and holes in the outer ring
- Optimized separable cage for better performance in case of different rolling element speed
- Available with lubrication groove and three lubrication holes in the outer ring and six lubrication holes in the inner ring (W513)
- Available with tapered bore (K/K30 suffixes)

Type ECA

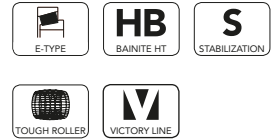
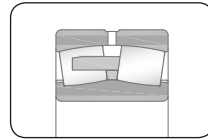

- Design used for large size bearings, based on CA design, with optimized roller set
- Inner ring with integral side ribs
- Symmetrical roller profile
- One-piece double pronged machined brass cage with or without separated slinger guided on the inner ring
- Lubrication groove and holes in the outer ring
- Available with lubrication groove and three lubrication holes in the outer ring and six lubrication holes in the inner ring (W513)
- Available with tapered bore (K/K30 suffixes)

Type MB

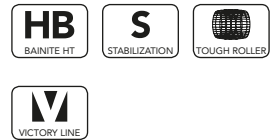
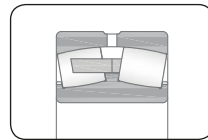

- Design used for medium size bearings operating at medium to high speeds, featuring high load carrying capacities
- Inner ring with integral side and central ribs
- Two-piece machined brass cage guided on the inner ring
- Lubrication groove and holes in the outer ring
- Available with lubrication groove and three lubrication holes in the outer ring and six lubrication holes in the inner ring (W513)
- Available with tapered bore (K/K30 suffixes)

Type CC

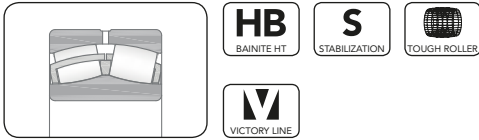

- Design used for medium size bearings operating at medium to high speeds and featuring high load carrying capacities
- Ribless inner ring
- Symmetrical roller profile
- Two-piece window type pressed steel cage guided on the inner ring
- Lubrication groove and holes in the outer ring
- Available with lubrication groove and three lubrication holes in the outer ring and six lubrication holes in the inner ring (W513)
- Available with tapered bore (K/K30 suffixes)

Type WOR

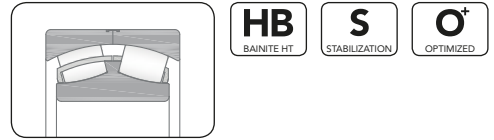

- Design used for gear output shaft of truck concrete mixers
- Inner ring with integral central rib
- Symmetrical or asymmetrical roller profile
- Two-piece pressed steel window type cage guided on the inner ring
- Wider outer ring (WOR) in one piece or split into two halves
- Permissible misalignment greater than standard execution
- Available with two-piece machined brass cage guided on the inner ring

Special designs and variants

Sealed type



- Design used for medium and large size bearings operating at medium speeds
- Inner ring with integral side ribs
- Symmetrical roller profile
- One-piece double pronged machined brass cage with integral slinger guided on the inner ring
- Integral rubber seals on both bearing sides for harsh working conditions (2CZ)
- Lubrication groove and holes in the outer ring
- Available with plugged lubrication holes in the outer ring (W77)
- Available with two-piece window type pressed steel cage guided on the inner ring

Type ECCS



- Design used for small to medium size bearings
- Ribless inner ring
- Symmetrical roller profile
- Two-piece pressed steel window type cage with slotted open face to improve lubricant flow and separated slinger guided on the inner ring
- Lubrication groove and six holes in the outer ring (W33X)
- Suitable for harsh environments
- Available with lubrication groove, three lubrication holes in the outer ring and six lubrication holes in the inner ring (W513)

Split type SSRB

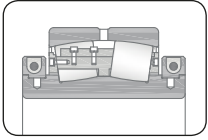

HB
 BAINITE HT

S
 STABILIZATION

O⁺
 OPTIMIZED

- Design used for medium and large size bearings
- Wider inner ring with integral side ribs
- Symmetrical roller profile
- Two-piece bolted double pronged machined brass cage guided on the inner ring
- Engineered for hard-to-reach positions (e.g. bucket wheel excavators)
- Design for easy mounting, dismounting and maintenance to reduced machine downtime
- Available in taylor-made dimension

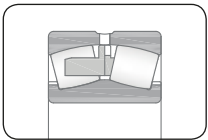
Type ROVSX/KROVSX

HB
 BAINITE HT

S
 STABILIZATION

O⁺
 OPTIMIZED

- Design used for vibratory equipment
- Inner ring with integral side ribs
- Symmetrical roller profile
- Two-piece machined brass cage guided on the outer ring
- Radial internal clearance higher than normal CN
- Running accuracy higher than standard execution
- Available with lubrication groove, three lubrication holes in the outer ring and six lubrication holes in the inner ring (W513)
- Available both with cylindrical and tapered bore (K/K30 suffixes)

Suffixes	Internal design
WOR	Wider outer ring. The value immediately following the WOR gives the width of the outer ring in mm
ROVS/ROVSX	Bearing for vibratory equipment
ID	Special inner diameter. The value immediately following the ID gives the inner diameter in mm
E	Optimized internal design for increased load ratings
SP	Special or non-standard bearing

Suffixes	Cage and design
M	Machined brass cage guided on rollers
MA	Machined brass cage guided on outer ring
MB	Machined brass cage guided on inner ring
CA	Double pronged machined brass cage
CAF	Double pronged machined steel cage
CAB	Steel pin-type cage with or without separate guiding slinger and pierced rollers
CC	Pressed steel cage
CCS	Pressed steel cage and axial lubrication grooves

Suffixes	Accuracy, clearance, running
ST	Special tolerance

Suffixes	Lubrication
W33	Annular groove and three lubrication holes in outer ring
W33X	Annular groove and more than three lubrication holes in outer ring
W513	W33 + six lubrication holes in inner ring
W513B	W33 + annular groove and six lubrication holes in inner ring
W513BX	W33X + annular groove and six lubrication holes in inner ring
W77	Annular groove and plugged lubrication holes in outer ring
W77X	Annular groove and more than three plugged lubrication holes in outer ring
W20	Three lubrication holes in the outer ring
WI	Lubrication grooves in side face of inner ring
G/R3	Filled with exceptionally good low noise profile and long life grease usable over a wide range of temperatures
G/R4	Filled with good low noise profile and high temperature, high speed and long life grease
C7A	Annular groove, seven lubrication holes and one blind counterbored hole in outer ring

Suffixes	External design
2CZ	Bearing with NBR/FKM seal on both sides and filled with EP lithium base grease
2CS	Bearing with NBR/FKM seal on both sides and filled with EP lithium base grease (BS2 series)
ZZ or 2Z	Shield on both sides
K	Tapered bore, taper 1:12
K30	Tapered bore, taper
N1	One locating slot in outer ring
N2I	Two slots in inner ring
N4I	Four slots in inner ring

Prefixes	Alternative designation
BS2	Spherical roller bearing followed by size indication
SRB	Out of standard spherical roller bearing followed by drawing number
SSRB	Out of standard split spherical roller bearing followed by drawing number



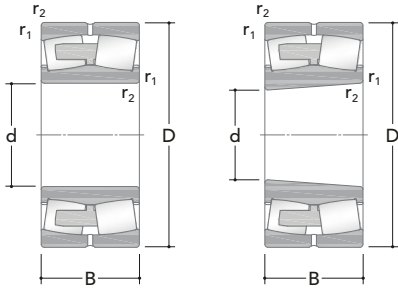

CA/CAF

K/K30

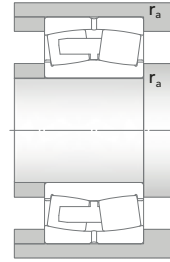

Main dimensions			Basic load ratings		Fatigue load limit C_u	Speed ratings		Designation
d	D	B	Dynamic C	Static C_0		Reference	Limiting	Standard design
[mm]			[kN]			[rpm]		
20	52	18	49,1	43,8	4,7	12200	15100	22205/20
25	52	18	49,1	43,8	4,7	12200	15100	22205
	62	17	48,8	41,2	4,5	8700	10500	21305
30	62	20	65,6	59,6	6,4	9300	12400	22206
	72	19	64,5	60,8	6,8	7600	8900	21306
35	72	23	87,9	83,4	9,1	8100	10200	22207
	80	21	79,0	70,9	8	6700	8400	21307
40	80	23	97,2	88,2	9,6	7200	9500	22208
	90	23	109	108	11,8	6200	8200	21308
	90	33	153	140	15	5400	6900	22308
45	85	23	103,5	97,9	10,8	7000	8800	22209
	100	25	127	125	13,5	5800	7300	21309
	100	36	187	183	19,6	4900	6000	22309
50	90	23	109	107	11,7	6500	8100	22210
	110	27	159	163	18,3	5200	6600	21310
	110	40	225	224	24	4500	5400	22310
55	100	25	131	127	13,7	5700	7400	22211
	120	29	159	163	18,3	5200	6700	21311
	120	43	279	279	29,9	4000	4900	22311
60	110	28	162	164	18,4	5100	6500	22212
	130	31	217	239	26,4	4400	5600	21312
	130	46	326	333	36	3600	4700	22312
65	100	35	137	172	20,3	4000	5600	24013
	120	31	195	213	23,7	4700	6100	22213

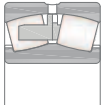

MA

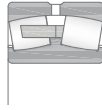

MB

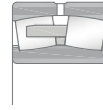

ECA



CC

Dimensions			Calculation	Mass	Designation	
d	r _{1,2min}	r _{amax}	factor		Cylindrical bore	Tapered bore
[mm]			e	[kg]		
20	1	1	0,35	0,28	22205/20	-
25	1	1	0,35	0,26	22205	22205 K
	1,1	1	0,3	0,28	21305	-
30	1	1	0,31	0,29	22206	22206 K
	1,1	1	0,27	0,41	21306	21306 K
35	1,1	1	0,31	0,45	22207	22207 K
	1,5	1,5	0,28	0,55	21307	21307 K
40	1,1	1	0,28	0,53	22208	22208 K
	1,5	1,5	0,24	0,75	21308	21308 K
	1,5	1,5	0,37	1,05	22308	22308 K
45	1,1	1	0,26	0,58	22209	22209 K
	1,5	1,5	0,24	0,99	21309	21309 K
	1,5	1,5	0,37	1,4	22309	22309 K
50	1,1	1	0,24	0,63	22210	22210 K
	2	2	0,24	1,35	21310	21310 K
	2	2	0,37	1,9	22310	22310 K
55	1,5	1,5	0,24	0,84	22211	22211 K
	2	2	0,24	1,7	21311	21311 K
	2	2	0,35	2,45	22311	22311 K
60	1,5	1,5	0,24	1,15	22212	22212 K
	2,1	2	0,22	2,1	21312	21312 K
	2,1	2	0,35	3,1	22312	22312 K
65	1,1	1	0,27	0,95	24013	24013 K30
	1,5	1,5	0,24	1,55	22213	22213 K

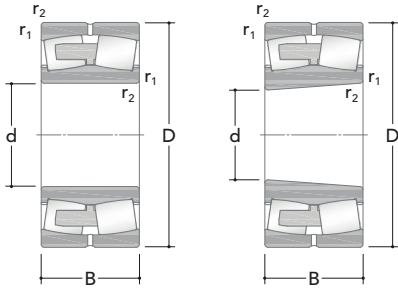

CA/CAF

K/K30

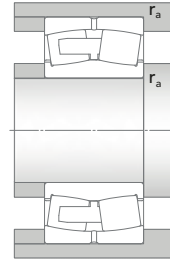

Main dimensions			Basic load ratings		Fatigue load limit	Speed ratings		Designation
d	D	B	Dynamic C	Static C ₀	C _u	Reference	Limiting	Standard design
[mm]			[kN]			[rpm]		
65	140	33	239	267	28,7	3900	5200	21313
(cont.)	140	48	361	353	37,3	3500	4300	22313
70	125	31	212	226	25,3	4700	5900	22214
	150	35	291	321	34,1	3700	4800	21314
	150	51	419	427	44,7	3100	3900	22314
75	115	40	178	229	28,1	3500	4700	24015
	130	31	216	240	26,5	4500	5400	22215
	160	37	289	321	34,1	3700	5000	21315
	160	55	470	474	47,9	3000	3800	22315
80	140	33	239	265	28,5	3900	5400	22216
	170	39	329	374	38,9	3400	4700	21316
	170	58	514	536	54,6	2700	3400	22316
85	150	36	287	323	34,3	3600	5000	22217
	180	41	327	371	38,6	3500	4700	21317
	180	60	586	617	60,7	2600	3400	22317
90	160	40	328	373	38,8	3500	4700	22218
	160	52,4	369	437	47,7	2500	3300	23218
	190	43	392	441	44,6	3300	4100	21318
	190	64	638	690	66,5	2400	3200	22318
95	170	43	387	446	45,1	3200	4200	22219
	200	45	430	488	48,8	3100	4000	21319
	200	67	693	762	73,2	2400	2900	22319
100	150	50	290	408	44,7	2600	3500	24020
	165	52	391	483	52,2	2800	3400	23120
	165	65	461	631	67	2200	2800	24120
	180	46	431	482	48,2	3100	4000	22220

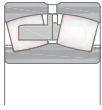

MA

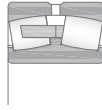

MB

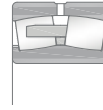

ECA

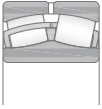

CC

Dimensions			Calculation	Mass	Designation	
d	r _{1,2min}	r _{amax}	factor		Cylindrical bore	Tapered bore
[mm]			e	[kg]		
65	2,1	2	0,22	2,55	21313	21313 K
(cont.)	2,1	2	0,35	3,75	22313	22313 K
70	1,5	1,5	0,23	1,55	22214	22214 K
	2,1	2	0,22	3,1	21314	21314 K
	2,1	2	0,33	4,55	22314	22314 K
75	1,1	1	0,28	1,55	24015	24015 K30
	1,5	1,5	0,22	1,7	22215	22215 K
	2,1	2	0,22	3,75	21315	21315 K
	2,1	2	0,35	5,55	22315	22315 K
80	2	2	0,22	2,1	22216	22216 K
	2,1	2	0,24	4,45	21316	21316 K
	2,1	2	0,35	6,6	22316	22316 K
85	2	2	0,22	2,7	22217	22217 K
	3	2,5	0,24	5,2	21317	21317 K
	3	2,5	0,33	7,65	22317	22317 K
90	2	2	0,24	3,4	22218	22218 K
	2	2	0,31	4,65	23218	23218 K
	3	2,5	0,24	6,1	21318	21318 K
	3	2,5	0,33	9,05	22318	22318 K
95	2,1	2	0,24	4,15	22219	22219 K
	3	2,5	0,24	7,05	21319	21319 K
	3	2,5	0,33	10,5	22319	22319 K
100	1,5	1,5	0,28	3,15	24020	24020 K30
	2	2	0,3	4,55	23120	23120 K
	2	2	0,37	5,65	24120	24120 K30
	2,1	2	0,24	4,9	22220	22220 K

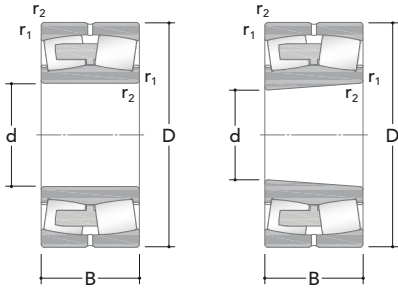

CA/CAF

K/K30

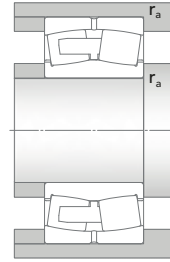

Main dimensions			Basic load ratings		Fatigue load limit C_u	Speed ratings		Designation Standard design
d	D	B	Dynamic C	Static C_0		Reference	Limiting	
[mm]			[kN]			[rpm]		
100 (cont.)	180	60,3	502	590	62	2200	3000	23220
	215	47	432	486	48,6	2700	3850	21320
	215	73	860	948	87,8	2200	2700	22320
110	170	45	330	432	45,7	3100	3800	23022
	170	60	439	619	66,9	2200	3100	24022
	180	56	452	578	60,3	2600	3200	23122
	180	69	545	741	77,1	1800	2700	24122
	200	53	577	629	61,9	2800	3400	22222
	200	69,8	625	759	75,9	2000	2800	23222
	240	80	985	1100	98,2	1800	2500	22322
120	180	46	366	508	52,8	3000	3500	23024
	180	60	461	662	67,2	2200	2900	24024
	200	62	543	683	69,8	2400	2900	23124
	200	80	679	940	94	1700	2300	24124
	205	68	528	863	91,3	2300	-	231581
	215	58	660	753	72,3	2600	3300	22224
	215	76	745	912	91,2	1800	2500	23224
	260	86	1030	1110	99,1	1850	2300	22324
	130	200	52	448	610	61	2600	3200
200		69	568	814	81,4	1800	2600	24026
210		64	595	766	76,6	2200	2800	23126
210		80	703	985	98,5	1500	2100	24126
230		64	753	920	87,1	2400	3200	22226
230		64	657	920	87,1	2200	-	29226
230		80	827	1050	103	1700	2300	23226
280		93	1178	1324	114	1650	2100	22326
140		210	53	486	672	67,2	2400	2900
	210	69	610	890	87	1800	2500	24028
	225	68	663	898	87,8	2000	2500	23128
	225	85	811	1140	110	1500	1900	24128

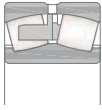

MA

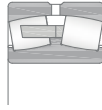

MB

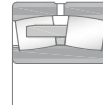

ECA



CC

Dimensions			Calculation	Mass	Designation	
d	r _{1,2min}	r _{amax}	factor		Cylindrical bore	Tapered bore
[mm]			e	[kg]		
100 (cont.)	2,1	2	0,33	6,85	23220	23220 K
	3	2,5	0,24	8,6	21320	21320 K
	3	2,5	0,33	13,5	22320	22320 K
110	2	2	0,23	3,8	23022	23022 K
	2	2	0,33	5	24022	24022 K30
	2	2	0,3	5,75	23122	23122 K
	2	2	0,37	7,1	24122	24122 K30
	2,1	2	0,25	7	22222	22222 K
	2,1	2	0,33	9,85	23222	23222 K
	3	2,5	0,33	18,5	22322	22322 K
120	2	2	0,22	4,2	23024	23024 K
	2	2	0,3	5,45	24024	24024 K30
	2	2	0,28	8	23124	23124 K
	2	2	0,37	10,5	24124	24124 K30
	2,1	2	0,31	9,2	231581	-
	2,1	2	0,26	8,7	22224	22224 K
	2,1	2	0,35	12	23224	23224 K
	3	2,5	0,35	23	22324	22324 K
	130	2	2	0,23	6	23026
2		2	0,31	8,05	24026	24026 K30
2		2	0,28	8,8	23126	23126 K
2		2	0,35	11	24126	24126 K30
3		2,5	0,27	11	22226	22226 K
3		2,5	0,27	11	29226	29226 K
3		2,5	0,33	14,5	23226	23226 K
4		3	0,35	29	22326	22326 K
140		2	2	0,22	6,55	23028
	2	2	0,3	8,55	24028	24028 K30
	2,1	2	0,28	10,5	23128	23128 K
	2,1	2	0,35	13,5	24128	24128 K30

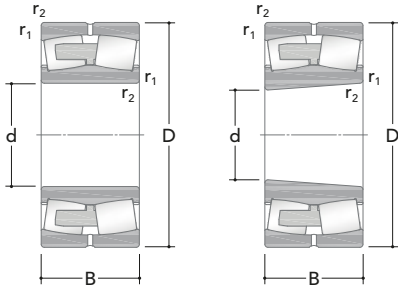

CA/CAF

K/K30

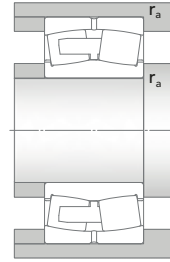

Main dimensions			Basic load ratings		Fatigue load limit C_u	Speed ratings		Designation
d	D	B	Dynamic C	Static C_0		Reference	Limiting	Standard design
[mm]			[kN]			[rpm]		
140 (cont.)	250	68	743	893	85,8	2200	2800	22228
	250	88	964	1240	119	1500	2100	23228
	300	102	1434	1540	130	1500	1900	22328
150	225	56	538	749	73,5	2200	2800	23030
	225	75	682	1030	100	1600	2300	24030
	250	80	890	1190	114	1800	2300	23130
	250	100	1036	1510	146	1300	1800	24130
	270	73	905	1070	102	2000	2600	22230
	270	96	1135	1457	137	1500	1900	23230
	320	108	1523	1740	146	1500	1800	22330
160	220	60	413	840	85	1700	-	24932
	240	60	613	879	83	2200	2600	23032
	240	80	777	1180	114	1500	2100	24032
	270	86	1035	1360	129	1700	2100	23132
	270	109	1229	1750	163	1200	1700	24132
	290	80	1048	1280	118	1800	2500	22232
	290	104	1263	1650	153	1400	1900	23232
	340	114	1694	1950	160	1400	1700	22332
	170	260	67	743	1040	98	2000	2400
260		90	973	1440	135	1500	2100	24034
280		88	1102	1490	136	1600	2100	23134
280		109	1271	1890	173	1100	1600	24134
310		86	1176	1450	131	1700	2300	22234
310		110	1481	1910	171	1300	1700	23234
360		120	1894	2130	174	1300	1600	22334
180	250	52	512	821	76	2300	2500	23936
	280	74	884	1240	113	1800	2300	23036
	280	100	1131	1710	154	1400	1900	24036
	300	96	1247	1730	157	1500	1900	23136

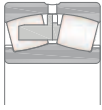

MA

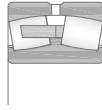

MB

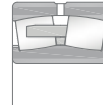

ECA



CC

Dimensions			Calculation	Mass	Designation	
d	r _{1,2min}	r _{amax}	factor		Cylindrical bore	Tapered bore
[mm]			e			
140	3	2,5	0,26	14	22228	22228 K
(cont.)	3	2,5	0,33	19	23228	23228 K
	4	3	0,35	36,5	22328	22328 K
150	2,1	2	0,22	7,95	23030	23030 K
	2,1	2	0,3	10,5	24030	24030 K30
	2,1	2	0,3	16	23130	23130 K
	2,1	2	0,37	20	24130	24130 K30
	3	2,5	0,26	18	22230	22230 K
	3	2,5	0,35	24,5	23230	23230 K
	4	3	0,35	43,5	22330	22330 K
160	2	2	0,24	6,85	24932	-
	2,1	2	0,22	9,7	23032	23032 K
	2,1	2	0,3	13	24032	24032 K30
	2,1	2	0,3	20,5	23132	23132 K
	2,1	2	0,4	25	24132	24132 K30
	3	2,5	0,26	22,5	22232	22232 K
	3	2,5	0,35	31	23232	23232 K
	4	3	0,35	52	22332	22332 K
170	2,1	2	0,23	13	23034	23034 K
	2,1	2	0,33	17,5	24034	24034 K30
	2,1	2	0,3	22	23134	23134 K
	2,1	2	0,37	27,5	24134	24134 K30
	4	3	0,27	28,5	22234	22234 K
	4	3	0,35	37,5	23234	23234 K
	4	3	0,33	61	22334	22334 K
180	2	2	0,18	7,9	23936	23936 K
	2,1	2	0,24	17	23036	23036 K
	2,1	2	0,33	23	24036	24036 K30
	3	2,5	0,3	28	23136	23136 K

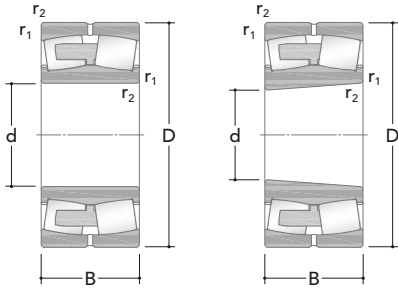

CA/CAF

K/K30

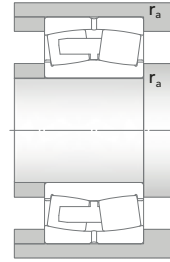

Main dimensions			Basic load ratings		Fatigue load limit	Speed ratings		Designation
d	D	B	Dynamic C	Static C ₀	C _u	Reference	Limiting	Standard design
[mm]			[kN]			[rpm]		
180 (cont.)	300	118	1464	2150	195	1000	1400	24136
	320	86	1218	1540	138	1600	2300	22236
	320	112	1554	2110	185	1200	1700	23236
	380	126	2110	2420	191	1200	1500	22336
190	260	52	490	791	76	2200	2300	23938
	290	75	931	1330	121	1700	2100	23038
	290	100	1186	1770	160	1300	1700	24038
	320	104	1454	2060	181	1400	1800	23138
	320	128	1621	2470	209	1000	1300	24138
	340	92	1320	1680	148	1500	2100	22238
	340	120	1788	2359	204	1200	1600	23238
200	400	132	2267	2640	207	1100	1400	22338
	280	60	658	1020	91	2000	2100	23940
	310	82	1058	1500	134	1600	1900	23040
	310	109	1355	2090	183	1200	1700	24040
	340	112	1679	2350	203	1400	1700	23140
	340	140	1896	2750	228	900	1200	24140
	360	98	1505	1920	165	1500	1900	22240
	360	128	1921	2690	227	1100	1500	23240
220	420	138	2450	2890	223	1100	1300	22340
	300	60	664	1060	91	1800	1900	23944
	340	90	1256	1830	160	1500	1700	23044
	340	118	1656	2560	209	1100	1500	24044
	370	120	1879	2740	231	1200	1500	23144
	370	150	2159	3330	283	790	1050	24144
	400	108	1813	2350	195	1400	1700	22244
	400	144	2534	3420	283	1000	1300	23244
240	460	145	2834	3400	256	940	1200	22344
	320	60	688	1182	100	1750	1800	23948

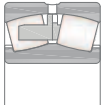

MA

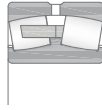

MB

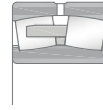

ECA



CC

Dimensions			Calculation	Mass	Designation	
d	r _{1,2min}	r _{amax}	factor		Cylindrical bore	Tapered bore
[mm]			e	[kg]		
180 (cont.)	3	2,5	0,37	34,5	24136	24136 K30
	4	3	0,26	29,5	22236	22236 K
	4	3	0,35	39,5	23236	23236 K
	4	3	0,35	71,5	22336	22336 K
190	2	2	0,16	8,3	23938	23938 K
	2,1	2	0,23	18	23038	23038 K
	2,1	2	0,31	24,5	24038	24038 K30
	3	2,5	0,31	35	23138	23138 K
	3	2,5	0,4	43	24138	24138 K30
	4	3	0,26	36,5	22238	22238 K
	4	3	0,35	48	23238	23238 K
	5	4	0,35	82,5	22338	22338 K
200	2,1	2	0,19	11,5	23940	23940 K
	2,1	2	0,24	23,5	23040	23040 K
	2,1	2	0,33	31	24040	24040 K30
	3	2,5	0,31	43	23140	23140 K
	3	2,5	0,4	53,5	24140	24140 K30
	4	3	0,26	43,5	22240	22240 K
	4	3	0,35	58	23240	23240 K
	5	4	0,33	95	22340	22340 K
220	2,1	2	0,16	12,5	23944	23944 K
	3	2,5	0,24	30,5	23044	23044 K
	3	2,5	0,33	40	24044	24044 K30
	4	3	0,3	53,5	23144	23144 K
	4	3	0,4	67	24144	24144 K30
	4	3	0,27	60,5	22244	22244 K
	4	3	0,35	81,5	23244	23244 K
	5	4	0,31	120	22344	22344 K
240	2,1	2	0,15	13,5	23948	23948 K

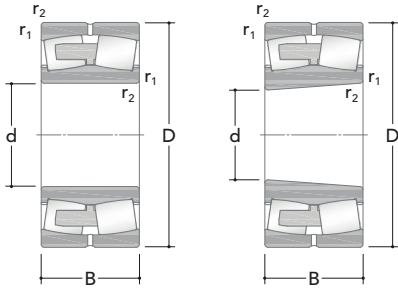

CA/CAF

K/K30

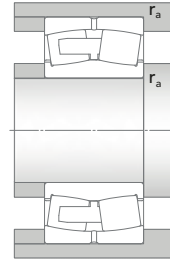

Main dimensions			Basic load ratings		Fatigue load limit	Speed ratings		Designation
d	D	B	Dynamic C	Static C ₀	C _u	Reference	Limiting	Standard design
[mm]			[kN]			[rpm]		
240 (cont.)	360	92	1321	2040	173	1400	1700	23048
	360	118	1665	2660	225	1000	1400	24048
	400	128	2147	3180	253	1100	1400	23148
	400	160	2440	3880	318	700	940	24148
	440	120	2245	2940	240	1200	1600	22248
	440	160	3033	4250	341	880	1140	23248
	500	155	3194	3940	286	890	1140	22348
260	320	45	379	915	82	1200	-	23852
	360	75	1038	1790	155	1560	1700	23952
	360	100	1122	2453	216	1200	-	24952
	400	104	1682	2520	210	1200	1500	23052
	400	140	2165	3440	284	920	1200	24052
	440	144	2521	3694	276	1000	1250	23152
	440	180	3076	4730	374	610	810	24152
	480	130	2721	3520	283	1100	1420	22252
	480	174	3407	4720	358	790	1029	23252
	540	165	3610	4470	319	780	987	22352
280	350	52	515	1189	105	1100	-	23856
	380	75	1022	1726	140	1430	1500	23956
	380	100	1060	2455	212	1100	-	24956
	420	106	1812	2820	222	1200	1400	23056
	420	140	2234	3760	282	860	1250	24056
	460	146	2730	4208	319	900	1170	23156
	460	180	3125	5080	413	560	800	24156
	500	130	2844	3730	298	1000	1330	22256
	500	176	3453	4793	363	750	1057	23256
	580	175	4147	5130	360	730	970	22356
300	380	60	512	1196	102	790	-	23860
	420	90	1400	2490	199	1300	1400	23960
	460	118	2192	3410	262	1100	1340	23060

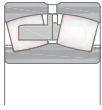

MA

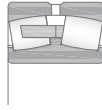

MB

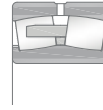

ECA

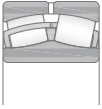

CC

Dimensions			Calculation	Mass	Designation	
d	r _{1,2min}	r _{amax}	factor		Cylindrical bore	Tapered bore
[mm]			e	[kg]		
240	3	2,5	0,23	33,5	23048	23048 K
(cont.)	3	2,5	0,3	43	24048	24048 K30
	4	3	0,3	66,5	23148	23148 K
	4	3	0,4	83	24148	24148 K30
	4	3	0,27	83	22248	22248 K
	4	3	0,35	110	23248	23248 K
	5	4	0,31	155	22348	22348 K
260	2	2	0,12	8,05	23852	23852 K
	2,1	2	0,18	23,5	23952	23952 K
	2,1	2	0,24	32	24952	-
	4	3	0,23	48,5	23052	23052 K
	4	3	0,33	65,5	24052	24052 K30
	4	3	0,31	90,5	23152	23152 K
	4	3	0,4	110	24152	24152 K30
	5	4	0,27	110	22252	22252 K
	5	4	0,35	140	23252	23252 K
	6	5	0,31	190	22352	22352 K
280	2	2	0,12	12	23856	23856 K
	2,1	2	0,16	25	23956	23956 K
	2,1	2	0,23	34,5	24956	-
	4	3	0,23	52,5	23056	23056 K
	4	3	0,31	69,5	24056	24056 K30
	5	4	0,3	97	23156	23156 K
	5	4	0,4	120	24156	24156 K30
	5	4	0,26	115	22256	22256 K
	5	4	0,35	150	23256	23256 K
	6	5	0,3	235	22356	22356 K
300	2,1	2	0,13	17	23860	23860 K
	3	2,5	0,19	39,5	23960	23960 K
	4	3	0,23	71,5	23060	23060 K

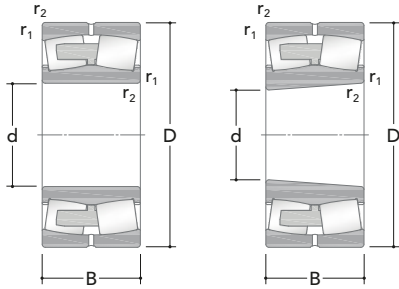

CA/CAF

K/K30

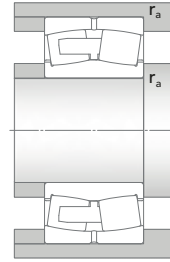

Main dimensions			Basic load ratings		Fatigue load limit	Speed ratings		Designation
d	D	B	Dynamic C	Static C ₀	C _u	Reference	Limiting	Standard design
[mm]			[kN]			[rpm]		
300 (cont.)	460	160	2779	4710	352	790	1050	24060
	500	160	3108	4688	348	850	1040	23160
	500	200	3825	6290	464	510	690	24160
	540	140	3228	4220	323	900	1200	22260
	540	192	4042	5810	422	700	850	23260
320	400	60	661	1656	140	1200	-	23864
	440	90	1502	2723	214	1250	1300	23964
	480	121	2328	3740	281	1000	1260	23064
	480	160	2920	5060	397	750	1080	24064
	540	176	3653	5504	400	790	960	23164
	540	218	4443	7090	509	470	610	24164
	580	150	3782	4990	382	860	1160	22264
580	208	4623	6690	474	630	850	23264	
340	420	60	699	1759	145	740	-	23868
	460	90	1485	2773	214	1200	1200	23968
	520	133	2813	4480	330	910	1110	23068
	520	180	3559	6160	472	700	950	24068
	580	190	4368	6670	474	740	860	23168
	580	243	5509	8540	622	400	540	24168
	620	224	5341	7720	544	500	690	23268
360	440	60	701	1866	153	-	-	23872
	480	90	1470	2710	217	1100	1160	23972
	540	134	2827	4790	344	890	1040	23072
	540	180	3757	6430	481	640	860	24072
	600	192	4511	6920	488	690	860	23172
	600	243	5828	9290	669	366	530	24172
	650	170	4442	6080	431	580	760	22272
	650	232	5694	8250	567	470	640	23272
380	520	106	1990	3790	284	1000	1050	23976

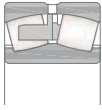

MA

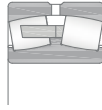

MB

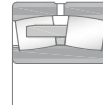

ECA



CC

Dimensions			Calculation	Mass	Designation	
d	r _{1,2min}	r _{amax}	factor		Cylindrical bore	Tapered bore
[mm]			e			
300	4	3	0,33	97	24060	24060 K30
(cont.)	5	4	0,3	125	23160	23160 K
	5	4	0,4	160	24160	24160 K30
	5	4	0,26	135	22260	22260 K
	5	4	0,35	190	23260	23260 K
	320	2,1	2	0,12	17,5	23864
	3	2,5	0,17	42	23964	23964 K
	4	3	0,23	78	23064	23064 K
	4	3	0,31	100	24064	24064 K30
	5	4	0,31	165	23164	23164 K
	5	4	0,4	210	24164	24164 K30
	5	4	0,26	175	22264	22264 K
	5	4	0,35	240	23264	23264 K
340	2,1	2	0,12	18,5	23868	-
	3	2,5	0,17	45,5	23968	23968 K
	5	4	0,24	105	23068	23068 K
	5	4	0,33	140	24068	24068 K30
	5	4	0,31	210	23168	23168 K
	5	4	0,4	280	24168	24168 K30
	6	5	0,35	295	23268	23268 K
360	2,1	1	0,11	20	23872	23872 K
	3	2,5	0,15	46	23972	23972 K
	5	4	0,23	110	23072	23072 K
	5	4	0,31	145	24072	24072 K30
	5	4	0,3	220	23172	23172 K
	5	4	0,4	280	24172	24172 K30
	6	5	0,26	255	22272	22272 K
	6	5	0,35	335	23272	23272 K
380	4	3	0,17	69	23976	23976 K

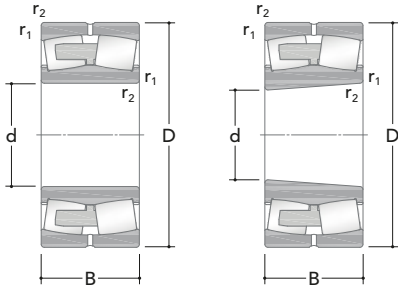

CA/CAF

K/K30

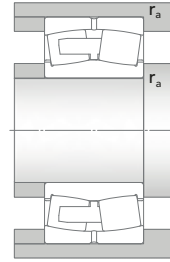

Main dimensions			Basic load ratings		Fatigue load limit	Speed ratings		Designation
d	D	B	Dynamic C	Static C ₀	C _u	Reference	Limiting	Standard design
[mm]			[kN]			[rpm]		
380 (cont.)	560	135	2888	4920	346	840	1040	23076
	560	180	3758	6680	467	600	810	24076
	620	194	4509	7000	493	520	850	23176
	620	243	5854	9730	705	330	470	24176
	680	240	6168	9070	615	470	660	23276
400	540	106	1999	3890	289	1000	1080	23980
	600	148	3360	5750	404	790	980	23080
	600	200	4423	7840	550	580	790	24080
	650	200	4863	7500	520	480	830	23180
	650	250	6294	10390	720	310	450	24180
	720	256	6958	10280	672	430	580	23280
	820	243	7768	10380	669	400	660	22380
420	560	106	2046	4110	297	910	970	23984
	620	150	3481	5960	412	540	940	23084
	620	200	4524	8190	577	470	770	24084
	700	224	5911	9230	615	440	770	23184
	700	280	7433	12520	851	290	430	24184
	760	272	7543	11510	759	410	540	23284
440	600	118	2475	4860	342	860	880	23988
	650	157	3832	6540	449	510	900	23088
	650	212	4892	9090	626	450	740	24088
	720	226	6201	9970	668	410	760	23188
	720	280	7816	13100	893	280	390	24188
	790	280	8216	12380	792	390	520	23288
460	580	118	2042	4830	340	560	990	24892
	620	118	2521	4930	350	540	860	23992
	680	163	4142	6820	456	510	850	23092
	680	218	5359	9990	669	450	710	24092
	760	240	6716	10660	671	400	680	23192

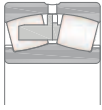

MA

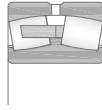

MB

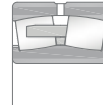

ECA



CC

Dimensions			Calculation	Mass	Designation	
d	r _{1,2min}	r _{amax}	factor		Cylindrical bore	Tapered bore
[mm]			e	[kg]		
380	5	4	0,22	115	23076	23076 K
(cont.)	5	4	0,3	150	24076	24076 K30
	5	4	0,3	230	23176	23176 K
	5	4	0,37	300	24176	24176 K30
	6	5	0,35	375	23276	23276 K
400	4	3	0,16	71	23980	23980 K
	5	4	0,23	150	23080	23080 K
	5	4	0,3	205	24080	24080 K30
	6	5	0,28	265	23180	23180 K
	6	5	0,37	340	24180	24180 K30
	6	5	0,35	450	23280	23280 K
	7,5	6	0,3	650	22380	22380 K
420	4	3	0,16	74,5	23984	23984 K
	5	4	0,22	155	23084	23084 K
	5	4	0,3	210	24084	24084 K30
	6	5	0,3	350	23184	23184 K
	6	5	0,4	445	24184	24184 K30
	7,5	6	0,35	535	23284	23284 K
440	4	3	0,16	99,5	23988	23988 K
	6	5	0,22	180	23088	23088 K
	6	5	0,3	245	24088	24088 K30
	6	5	0,3	360	23188	23188 K
	6	5	0,37	460	24188	24188 K30
	7,5	6	0,35	590	23288	23288 K
460	3	2,5	0,17	75,5	24892	24892 K30
	4	3	0,16	105	23992	23992 K
	6	5	0,22	205	23092	23092 K
	6	5	0,28	275	24092	24092 K30
	7,5	6	0,3	440	23192	23192 K

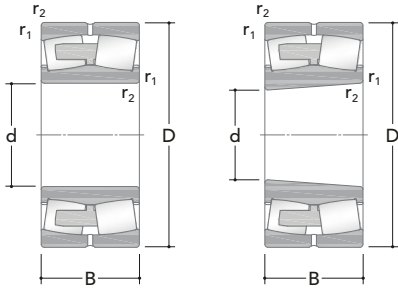

CA/CAF

K/K30

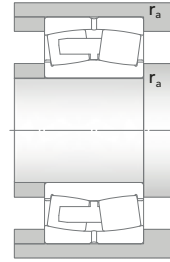

Main dimensions			Basic load ratings		Fatigue load limit	Speed ratings		Designation
d	D	B	Dynamic C	Static C ₀	C _u	Reference	Limiting	Standard design
[mm]			[kN]			[rpm]		
460	760	300	8564	14350	983	260	380	24192
(cont.)	830	296	8837	13497	867	370	500	23292
480	600	90	1422	3790	283	480	-	23896
	650	128	2949	5630	400	520	850	23996
	700	165	3966	6770	448	490	820	23096
	700	218	5421	10300	688	420	660	24096
	790	248	7335	11950	777	370	660	23196
	790	308	9062	15520	1035	240	340	24196
	870	310	9691	14750	934	350	470	23296
500	620	90	1451	4035	293	470	-	238/500
	670	128	2960	5910	409	472	820	239/500
	720	167	4415	7710	504	450	800	230/500
	720	218	5876	10940	731	400	600	240/500
	830	264	7975	12840	826	350	620	231/500
	830	325	10163	16920	1115	240	330	241/500
	920	336	11211	17000	1042	330	440	232/500
530	650	118	2119	5230	375	490	850	248/530
	710	136	3292	6590	457	460	780	239/530
	780	185	5327	9260	607	420	680	230/530
	780	250	6904	13040	820	370	600	240/530
	870	272	8581	13740	864	330	570	231/530
	870	335	10955	18880	1212	220	320	241/530
	980	355	13324	20210	1209	300	420	232/530
560	750	140	3537	7060	490	400	750	239/560
	820	195	5693	10040	659	400	670	230/560
	820	258	7504	14590	979	350	540	240/560
	920	280	9525	15930	976	310	560	231/560
	920	355	12551	21460	1331	200	280	241/560
	1030	365	13783	21660	1300	260	380	232/560

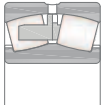

MA

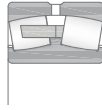

MB

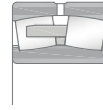

ECA



CC

Dimensions			Calculation	Mass	Designation	
d	r _{1,2min}	r _{amax}	factor		Cylindrical bore	Tapered bore
[mm]			e	[kg]		
460	7,5	6	0,37	560	24192	24192 K30
(cont.)	7,5	6	0,35	695	23292	23292 K
480	3	2,5	0,13	61	23896	23896 K
	5	4	0,18	125	23996	23996 K
	6	5	0,21	215	23096	23096 K
	6	5	0,28	285	24096	24096 K30
	7,5	6	0,3	485	23196	23196 K
	7,5	6	0,37	605	24196	24196 K30
	7,5	6	0,35	800	23296	23296 K
500	3	2,5	0,12	62	238/500	238/500 K
	5	4	0,17	130	239/500	239/500 K
	6	5	0,21	225	230/500	230/500 K
	6	5	0,26	295	240/500	240/500 K30
	7,5	6	0,3	580	231/500	231/500 K
	7,5	6	0,37	700	241/500	241/500 K30
	7,5	6	0,35	985	232/500	232/500 K
530	3	2,5	0,15	86	248/530	248/530 K30
	5	4	0,17	155	239/530	239/530 K
	6	5	0,22	310	230/530	230/530 K
	6	5	0,28	410	240/530	240/530 K30
	7,5	6	0,3	645	231/530	231/530 K
	7,5	6	0,37	830	241/530	241/530 K30
	9,5	8	0,35	1200	232/530	232/530 K
560	5	4	0,16	175	239/560	239/560 K
	6	5	0,22	355	230/560	230/560 K
	6	5	0,28	465	240/560	240/560 K30
	7,5	6	0,3	740	231/560	231/560 K
	7,5	6	0,35	985	241/560	241/560 K30
	9,5	8	0,35	1350	232/560	232/560 K

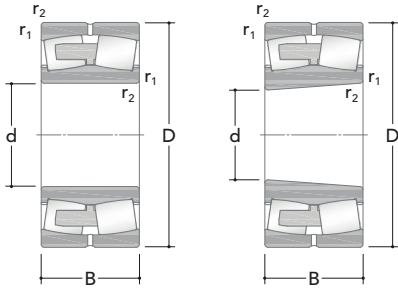

CA/CAF

K/K30

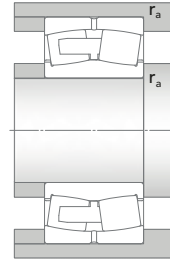

Main dimensions			Basic load ratings		Fatigue load limit	Speed ratings		Designation
d	D	B	Dynamic C	Static C ₀	C _u	Reference	Limiting	Standard design
[mm]			[kN]			[rpm]		
600	800	150	3955	8253	567	390	670	239/600
	870	200	6202	11250	725	370	600	230/600
	870	272	8716	16700	1061	310	500	240/600
	980	300	10814	17810	1088	290	480	231/600
	980	375	13384	23570	1458	180	270	241/600
	1090	388	15786	25430	1456	230	360	232/600
630	780	112	2502	6050	412	400	660	238/630
	850	165	4693	9660	621	370	600	239/630
	920	212	6968	12480	779	350	600	230/630
	920	290	9119	17900	1114	300	470	240/630
	1030	315	12778	20390	1196	240	470	231/630
	1030	400	15082	26730	1614	170	250	241/630
670	820	112	2592	6420	431	360	620	238/670
	900	170	5134	10760	677	330	600	239/670
	980	230	7799	14410	869	310	510	230/670
	980	308	10378	20350	1287	270	450	240/670
	1090	336	13199	22465	1324	220	430	231/670
	1090	412	16093	28910	1755	160	230	241/670
	1220	438	19011	30260	1687	200	320	232/670
710	870	118	3049	7490	499	330	600	238/710
	950	180	5693	11840	740	310	530	239/710
	950	243	6871	15580	929	270	430	249/710
	1030	236	8521	16280	964	280	500	230/710
	1030	315	11237	22380	1404	240	390	240/710
	1150	345	14637	25600	1506	220	400	231/710
	1150	438	17613	32400	1894	150	210	241/710
	1280	450	21348	33960	1969	180	280	232/710
750	920	128	3387	8460	547	310	520	238/750
	1000	185	6164	13060	792	290	480	239/750

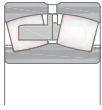

MA

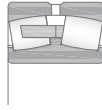

MB

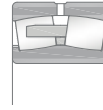

ECA

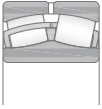

CC

Dimensions			Calculation	Mass	Designation	
d	r _{1,2min}	r _{amax}	factor		Cylindrical bore	Tapered bore
[mm]			e			
600	5	4	0,17	220	239/600	239/600 K
	6	5	0,22	405	230/600	230/600 K
	6	5	0,3	520	240/600	240/600 K30
	7,5	6	0,3	895	231/600	231/600 K
	7,5	6	0,37	1200	241/600	241/600 K30
	9,5	8	0,35	1600	232/600	232/600 K
630	4	3	0,12	120	238/630	238/630 K
	6	5	0,17	280	239/630	239/630 K
	7,5	6	0,21	485	230/630	230/630 K
	7,5	6	0,28	645	240/630	240/630 K30
	7,5	6	0,3	1050	231/630	231/630 K
	7,5	6	0,37	1400	241/630	241/630 K30
670	4	3	0,11	130	238/670	238/670 K
	6	5	0,17	315	239/670	239/670 K
	7,5	6	0,21	600	230/670	230/670 K
	7,5	6	0,28	790	240/670	240/670 K30
	7,5	6	0,3	1250	231/670	231/670 K
	7,5	6	0,37	1600	241/670	241/670 K30
	12	10	0,35	2270	232/670	232/670 K
710	4	3	0,11	153	238/710	238/710 K
	6	5	0,17	365	239/710	239/710 K
	6	5	0,22	495	249/710	249/710 K30
	7,5	6	0,21	670	230/710	230/710 K
	7,5	6	0,27	895	240/710	240/710 K30
	9,5	8	0,28	1450	231/710	231/710 K
	9,5	8	0,37	1900	241/710	241/710 K30
	12	10	0,35	2610	232/710	232/710 K
	750	5	4	0,11	185	238/750
6		5	0,16	420	239/750	239/750 K

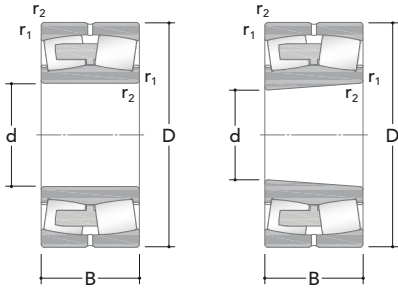

CA/CAF

K/K30

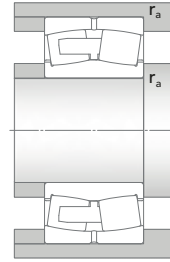

Main dimensions			Basic load ratings		Fatigue	Speed ratings		Designation
d	D	B	Dynamic C	Static C ₀	load limit C _u	Reference	Limiting	Standard design
[mm]			[kN]			[rpm]		
750 (cont.)	1000	250	7757	17930	1096	260	410	249/750
	1090	250	9901	18290	1082	260	470	230/750
	1090	335	12054	24630	1438	220	380	240/750
	1220	365	16356	28930	1696	200	380	231/750
	1220	475	20291	37230	2144	140	190	241/750
	1360	475	21420	36390	1994	170	260	232/750
800	980	180	4811	12720	818	300	500	248/800
	1060	195	6490	14270	863	250	460	239/800
	1060	258	8123	19260	1058	220	370	249/800
	1150	258	10257	19790	1148	230	420	230/800
	1150	345	13547	28370	1652	200	340	240/800
	1280	375	18285	31400	1794	180	350	231/800
	1280	475	21893	40380	2313	130	180	241/800
1420	488	25160	42410	2328	160	250	232/800	
850	1030	136	3880	9980	629	240	470	238/850
	1120	200	7031	15420	919	240	410	239/850
	1120	272	9290	22600	1358	200	360	249/850
	1220	272	11247	21180	1226	220	400	230/850
	1220	365	15297	31230	1884	180	310	240/850
	1360	400	23963	45042	2502	121	164	231/850
	1360	500	28031	48742	2640	145	229	241/850
	1420	515	25772	48900	2694	110	160	241/900
900	1090	190	5411	15160	941	220	430	248/900
	1180	206	7621	16920	995	220	400	239/900
	1280	280	11799	23040	1311	200	350	230/900
	1280	375	16375	34200	2022	170	300	240/900
	1420	515	25772	48900	2694	110	160	241/900
950	1250	224	8669	19320	1104	200	380	239/950
	1250	300	10561	25480	1470	160	290	249/950
	1360	300	14561	28030	1574	180	340	230/950
	1360	412	17680	38310	2200	150	270	240/950

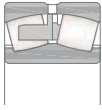

MA

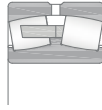

MB

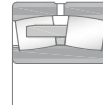

ECA



CC

Dimensions			Calculation	Mass	Designation	
d	r _{1,2min}	r _{amax}	factor		Cylindrical bore	Tapered bore
[mm]			e			
750	6	5	0,22	560	249/750	249/750 K30
(cont.)	7,5	6	0,21	795	230/750	230/750 K
	7,5	6	0,28	1070	240/750	240/750 K30
	9,5	8	0,28	1700	231/750	231/750 K
	9,5	8	0,37	2100	241/750	241/750 K30
	15	12	0,35	3050	232/750	232/750 K
800	5	4	0,15	300	248/800	248/800 K30
	6	5	0,16	470	239/800	239/800 K
	6	5	0,21	640	249/800	249/800 K30
	7,5	6	0,2	895	230/800	230/800 K
	7,5	6	0,27	1200	240/800	240/800 K30
	9,5	8	0,28	1920	231/800	231/800 K
	9,5	8	0,35	2300	241/800	241/800 K30
	15	12	0,33	3280	232/800	232/800 K
850	5	4	0,11	240	238/850	238/850 K
	6	5	0,16	560	239/850	239/850 K
	6	5	0,22	740	249/850	249/850 K30
	7,5	6	0,2	1050	230/850	230/850 K
	7,5	6	0,27	1410	240/850	240/850 K30
	12	10	0,28	2200	231/850	231/850 K
	12	10	0,35	2770	241/850	241/850 K30
900	5	4	0,14	370	248/900	248/900 K30
	6	5	0,15	605	239/900	239/900 K
	7,5	6	0,2	1200	230/900	230/900 K
	7,5	6	0,26	1570	240/900	240/900 K30
	12	10	0,35	3350	241/900	241/900 K30
950	7,5	6	0,15	755	239/950	239/950 K
	7,5	6	0,21	1020	249/950	249/950 K30
	7,5	6	0,2	1450	230/950	230/950 K
	7,5	6	0,27	1990	240/950	240/950 K30

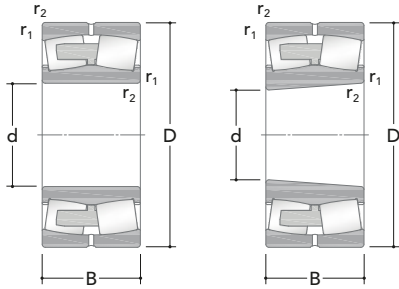

CA/CAF

K/K30

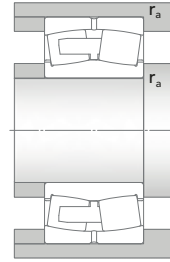

Main dimensions			Basic load ratings		Fatigue	Speed ratings		Designation
d	D	B	Dynamic C	Static C ₀	load limit C _u	Reference	Limiting	Standard design
[mm]			[kN]			[rpm]		
950	1500	545	28438	54290	2961	100	140	241/950
(cont.)								
1000	1220	165	5465	14270	848	200	340	238/1000
	1320	315	11835	28660	1443	150	280	249/1000
	1420	308	14311	30350	1692	160	320	230/1000
	1420	412	18907	40090	2217	150	240	240/1000
	1580	462	25356	47060	2500	130	250	231/1000
	1580	580	31021	61860	3342	90	130	241/1000
1060	1280	165	5638	14710	848	180	330	238/1060
	1280	218	6831	19840	1190	180	340	248/1060
	1400	250	11436	25720	1415	160	320	239/1060
	1400	335	13271	32330	1791	150	240	249/1060
	1500	325	15898	33610	1809	150	280	230/1060
	1500	438	20759	45120	2430	140	230	240/1060
1120	1360	243	8357	23910	1395	160	300	248/1120
	1460	335	13811	34240	1816	130	230	249/1120
	1580	462	22569	49160	2655	120	210	240/1120
1180	1420	180	6851	18460	1072	150	280	238/1180
	1420	243	8965	26560	1535	150	280	248/1180
	1540	272	13119	30970	1658	140	270	239/1180
	1540	355	15586	40280	2148	120	210	249/1180
	1660	475	25876	57900	3019	120	190	240/1180
1250	1750	375	21125	44100	2274	120	210	230/1250
1320	1600	280	11276	33340	1851	130	230	248/1320
	1720	400	18889	48350	2467	100	170	249/1320
1500	1820	315	14757	44140	2354	100	190	248/1500
	1950	450	20889	62830	3142	-	-	249/1500

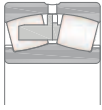

MA

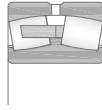

MB

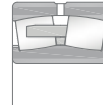

ECA



CC

Dimensions			Calculation	Mass	Designation	
d	r _{1,2min}	r _{amax}	factor		Cylindrical bore	Tapered bore
[mm]			e			
950	12	10	0,35	3540	241/950	241/950 K30
(cont.)						
1000	6	5	0,12	410	238/1000	238/1000 K
	7,5	6	0,21	1200	249/1000	249/1000 K30
	7,5	6	0,19	1600	230/1000	230/1000 K
	7,5	6	0,26	2140	240/1000	240/1000 K30
	12	10	0,28	3500	231/1000	231/1000 K
	12	10	0,35	4300	241/1000	241/1000 K30
1060	6	5	0,11	435	238/1060	238/1060 K
	6	5	0,14	570	248/1060	248/1060 K30
	7,5	6	0,16	1100	239/1060	239/1060 K
	7,5	6	0,21	1400	249/1060	249/1060 K30
	9,5	8	0,19	1840	230/1060	230/1060 K
	9,5	8	0,26	2520	240/1060	240/1060 K30
1120	6	5	0,15	735	248/1120	248/1120 K30
	7,5	6	0,2	1500	249/1120	249/1120 K30
	9,5	8	0,26	2930	240/1120	240/1120 K30
1180	6	5	0,11	575	238/1180	238/1180 K
	6	5	0,14	770	248/1180	248/1180 K30
	7,5	6	0,16	1400	239/1180	239/1180 K
	7,5	6	0,2	1800	249/1180	249/1180 K30
	9,5	8	0,26	3320	240/1180	240/1180 K30
1250	9,5	8	0,19	2840	230/1250	230/1250 K
1320	6	5	0,15	1160	248/1320	248/1320 K30
	7,5	6	0,21	2500	249/1320	249/1320 K30
1500	7,5	6	0,15	1710	248/1500	248/1500 K30
	9,5	8	0,2	3550	249/1500	249/1500 K30

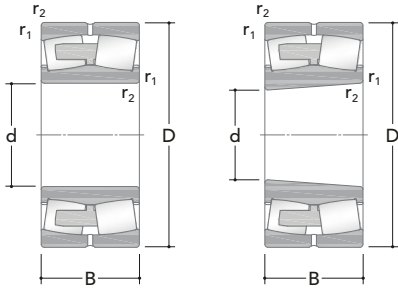

CA/CAF

K/K30

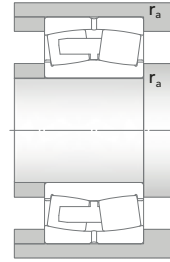

Main dimensions			Basic load ratings		Fatigue load limit	Speed ratings		Designation
d	D	B	Dynamic C	Static C ₀	C _u	Reference	Limiting	Standard design
[mm]			[kN]			[rpm]		
1800	2180	375	20274	62690	3035	70	120	248/1800

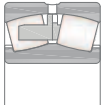

MA

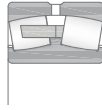

MB

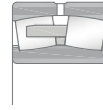

ECA



CC

Dimensions			Calculation	Mass	Designation	
d	r _{1,2min}	r _{amax}	factor		Cylindrical bore	Tapered bore
[mm]			e		[kg]	
1800	9,5	8	0,15	2900	248/1800	248/1800 K30

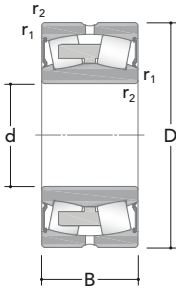

Sealed

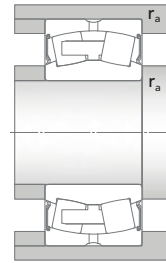

Main dimensions			Basic load ratings		Fatigue load limit C_u	Speed ratings	Designation
d	D	B	Dynamic C	Static C_0		Limiting	Standard design
[mm]			[kN]			[rpm]	
25	52	23	49,7	43,8	4,73	5300	BS2 2205
30	62	25	65,3	59,3	6,3	4580	BS2 2206
35	72	28	87,5	84,4	9,2	3760	BS2 2207
40	80	28	100,4	88,5	9,6	3360	BS2 2208
	90	38	156,3	139,0	14,9	3390	BS2 2308
45	85	28	103,1	97,7	10,8	3100	BS2 2209
	100	42	193	180	19,3	2900	BS2 2309
50	90	28	106	107	11,7	2830	BS2 2210
	110	45	228	221	23,7	2600	BS2 2310
55	100	31	129	125	13,5	2560	BS2 2211
	120	49	279	278	29,8	2500	BS2 2311
60	110	34	159	166	18,6	2400	BS2 2212
	130	53	329	329	35,8	2150	BS2 2312
65	100	35	140	172	20,3	2300	24013
	120	38	194	214	23,8	2150	BS2 2213
	140	56	353	360	38	2045	BS2 2313
70	125	38	210	224	25,1	2000	BS2 2214
	150	60	416	426	44,6	1890	BS2 2314
75	115	40	180	229	28,1	1960	24015
	130	38	219	243	26,9	1900	BS2 2215
	160	64	463	472	47,7	1830	BS2 2315
80	140	40	246	270	29	1740	BS2 2216

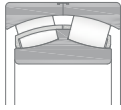

WOR



ECCS

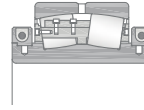

SSRB

Dimensions			Calculation factor e	Mass	Designation	
d	r _{1,2min}	r _{amax}			Cylindrical bore	Tapered bore
[mm]				[kg]		
25	1	1	0,35	0,26	BS2 2205 2CS	-
30	1	1	0,31	0,34	BS2 2206 2CS	-
35	1,1	1	0,31	0,52	BS2 2207 2CS	-
40	1,1	1	0,28	0,57	BS2 2208 2CS	BS2 2208 K2CS
	1,5	1,5	0,37	1,2	BS2 2308 2CS	-
45	1,1	1	0,26	0,66	BS2 2209 2CS	BS2 2209 K2CS
	1,5	1,5	0,37	1,6	BS2 2309 2CS	-
50	1,1	1	0,24	0,7	BS2 2210 2CS	BS2 2210 K2CS
	2	2	0,37	2,1	BS2 2310 2CS	-
55	1,5	1,5	0,24	1	BS2 2211 2CS	BS2 2211 K2CS
	2	2	0,35	2,8	BS2 2311 2CS	-
60	1,5	1,5	0,24	1,3	BS2 2212 2CS	BS2 2212 K2CS
	2,1	2	0,35	3,4	BS2 2312 2CS	-
65	1,1	1	0,27	0,95	24013 2CZ	-
	1,5	1,5	0,24	1,6	BS2 2213 2CS	BS2 2213 K2CS
	2,1	2	0,35	4,15	BS2 2313 2CS	-
70	1,5	1,5	0,23	1,8	BS2 2214 2CS	BS2 2214 K2CS
	2,1	2	0,33	5,1	BS2 2314 2CS	-
75	1,1	1	0,28	1,55	24015 2CS	-
	1,5	1,5	0,22	2,1	BS2 2215 2CS	BS2 2215 K2CS
	2,1	2	0,35	6,5	BS2 2315 2CS	-
80	2	2	0,22	2,4	BS2 2216 2CS	BS2 2216 K2CS

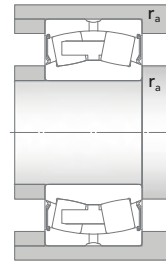
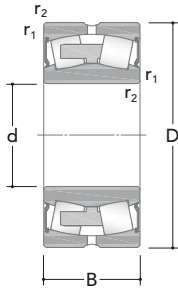

Sealed

Main dimensions			Basic load ratings		Fatigue load limit	Speed ratings	Designation
d	D	B	Dynamic C	Static C ₀	C _u	Limiting	Standard design
[mm]			[kN]			[rpm]	
80	170	67	519	533	54,3	1800	BS2 2316
(cont.)							
85	150	44	292	321	34,1	1640	BS2 2217
90	160	48	326	372	38,7	1568	BS2 2218
	160	52,4	350	437	47,7	1491	23218
95	170	51	401	445	45	1490	BS2 2219
100	150	50	296	408	44,7	1500	24020
	165	52	391	483	52,2	1490	23120
	165	65	467	631	67	1510	24120
	180	55	432	484	48,4	1400	BS2 2220
	180	60,3	508	590	62	1400	23220
110	170	45	325	432	46	1340	23022
	170	60	437	619	67	600	24022
	180	56	460	578	60	700	23122
	180	69	549	741	77	550	24122
	200	63	566	636	63	1280	BS2 2222
	200	69,8	631	758	76	550	23222
120	180	46	369	508	53	1220	23024
	180	60	452	662	67	600	24024
	200	80	675	940	94	500	24124
	215	69	641	750	72	1220	BS2 2224
	215	76	724	912	91	530	23224
	260	86	1025	1111	99	530	22324
130	200	52	458	610	62	700	23026
	200	69	559	814	80	540	24026
	210	80	713	985	99	460	24126
	230	75	762	926	88	600	BS2 2226

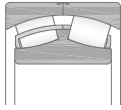

WOR

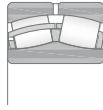

ECCS

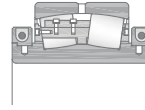

SSRB

Dimensions			Calculation factor e	Mass [kg]	Designation	
d [mm]	r _{1,2min}	r _{amax}			Cylindrical bore	Tapered bore
80	2,1	2	0,35	7,2	BS2 2316 2CS	-
(cont.)						
85	2	2	0,22	3	BS2 2217 2CS	BS2 2217 K2CS
90	2	2	0,24	3,7	BS2 2218 2CS	BS2 2218 K2CS
	2	2	0,31	4,65	23218 2CZ	-
95	2,1	2	0,24	4,65	BS2 2219 2CS	BS2 2219 K2CS
100	1,5	1,5	0,28	3,15	24020 2CZ	-
	2	2	0,27	4,55	23120 2CZ	-
	2	2	0,35	5,65	24120 2CZ	-
	2,1	2	0,24	5,5	BS2 2220 2CS	BS2 2220 K2CS
	2,1	2	0,3	6,85	23220 2CZ	-
110	2	2	0,23	3,8	23022 2CZ	-
	2	2	0,33	5	24022 2CZ	-
	2	2	0,27	5,75	23122 2CZ	23122 K2CZ
	2	2	0,35	7,1	24122 2CZ	-
	2,1	2	0,25	7,6	BS2 2222 2CS	BS2 2222 K2CS
	2,1	2	0,33	9,85	23222 2CZ	23222 K2CZ
120	2	2	0,2	4,2	23024 2CZ	-
	2	2	0,28	5,45	24024 2CZ	-
	2	2	0,37	10,5	24124 2CZ	-
	2,1	2	0,26	9,75	BS2 2224 2CS	BS2 2224 K2CS
	2,1	2	0,33	12	23224 2CZ	23224 K2CZ
	3	2,5	0,33	23	22324 2CZ	22324 K2CZ
130	2	2	0,21	6	23026 2CZ	23026 K2CZ
	2	2	0,3	8,05	24026 2CZ	-
	2	2	0,33	11	24126 2CZ	-
	3	2,5	0,27	11	BS2 2226 2CS	BS2 2226 K2CS

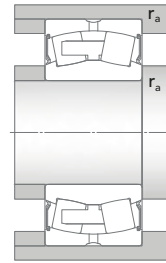
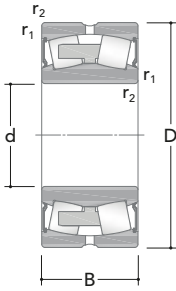

Sealed

Main dimensions			Basic load ratings		Fatigue load limit	Speed ratings	Designation
d	D	B	Dynamic C	Static C ₀	C _u	Limiting	Standard design
[mm]			[kN]			[rpm]	
130	230	80	821	1050	103	460	23226
(cont.)	280	93	1159	1304	113	450	22326
140	210	53	477	672	67	600	23028
	210	69	596	890	87	500	24028
	225	85	783	1140	110	400	24128
	250	68	742	893	86	600	22228
	250	88	970	1240	119	430	23228
	300	102	1364	1540	130	380	22328
150	225	56	528	749	73	600	23030
	225	75	669	1030	99	460	24030
	250	80	898	1190	113	500	23130
	250	100	1061	1510	144	360	24130
	270	73	912	1070	101	560	22230
	270	96	1118	1487	140	380	23230
	320	108	1519	1730	144	350	22330
160	240	60	624	879	83	600	23032
	240	80	779	1180	112	400	24032
	270	86	1043	1378	127	470	23132
	270	109	1214	1750	162	330	24132
	290	80	1033	1280	117	520	22232
	340	114	1680	1950	159	330	22332
170	260	67	761	1071	99	560	23034
	260	90	951	1488	136	350	24034
	280	88	1079	1490	136	420	23134
	280	109	1288	1887	172	310	24134
	310	86	1189	1450	133	440	22234
180	280	74	900	1267	114	500	23036
	280	100	1155	1710	154	330	24036



WOR



ECCS

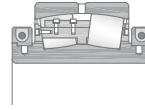

SSRB

Dimensions			Calculation factor e	Mass [kg]	Designation	
d [mm]	r _{1,2min}	r _{amax}			Cylindrical bore	Tapered bore
130 (cont.)	3	2,5	0,31	14,5	23226 2CZ	23226 K2CZ
	4	3	0,33	29	22326 2CZ	22326 K2CZ
140	2	2	0,2	6,55	23028 2CZ	23028 K2CZ
	2	2	0,28	8,55	24028 2CZ	-
	2,1	2	0,35	13,5	24128 2CZ	-
	3	2,5	0,24	14	22228 2CZ	22228 K2CZ
	3	2,5	0,33	19	23228 2CZ	23228 K2CZ
	4	3	0,33	36,5	22328 2CZ	22328 K2CZ
150	2,1	2	0,2	7,95	23030 2CZ	23030 K2CZ
	2,1	2	0,28	10,5	24030 2CZ	-
	2,1	2	0,28	16	23130 2CZ	23130 K2CZ
	2,1	2	0,37	20	24130 2CZ	-
	3	2,5	0,24	18	22230 2CZ	22230 K2CZ
	3	2,5	0,33	24,5	23230 2CZ	23230 K2CZ
	4	3	0,33	43,5	22330 2CZ	22330 K2CZ
160	2,1	2	0,2	9,7	23032 2CZ	23032 K2CZ
	2,1	2	0,28	13	24032 2CZ	-
	2,1	2	0,28	20,5	23132 2CZ	23132 K2CZ
	2,1	2	0,37	25	24132 2CZ	-
	3	2,5	0,25	22,5	22232 2CZ	22232 K2CZ
	4	3	0,33	52	22332 2CZ	22332 K2CZ
170	2,1	2	0,22	13	23034 2CZ	23034 K2CZ
	2,1	2	0,3	17,5	24034 2CZ	-
	2,1	2	0,28	22	23134 2CZ	23134 K2CZ
	2,1	2	0,37	27,5	24134 2CZ	-
	4	3	0,25	28,5	22234 2CZ	22234 K2CZ
180	2,1	2	0,22	17	23036 2CZ	23036 K2CZ
	2,1	2	0,31	23	24036 2CZ	-

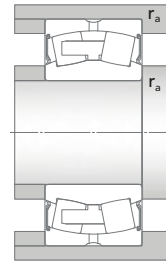
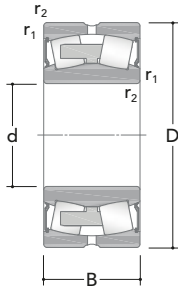

Sealed

Main dimensions			Basic load ratings		Fatigue load limit	Speed ratings	Designation
d	D	B	Dynamic C	Static C ₀	C _u	Limiting	Standard design
[mm]			[kN]			[rpm]	
180 (cont.)	300	96	1259	1775	158	370	23136
	300	118	1424	2150	195	320	24136
	320	86	1248	1540	138	470	22236
190	320	104	1431	2060	181	350	23138
	320	128	1643	2470	209	300	24138
	340	92	1355	1680	148	430	22238
200	310	82	1060	1500	134	420	23040
	340	112	1645	2350	203	330	23140
	340	140	1899	2750	228	280	24140
	360	98	1503	1920	165	380	22240
	360	128	1917	2690	231	300	23240
220	300	60	673	1060	91	540	23944
	340	90	1240	1830	160	380	23044
	370	120	1870	2740	231	320	23144
	400	108	1828	2350	199	340	22244
	460	145	2788	3400	256	270	22344
240	360	92	1319	2040	173	360	23048
	400	128	2169	3180	253	290	23148
260	400	104	1653	2520	210	310	23052
	440	144	2621	3830	285	280	23152
280	460	146	2812	4170	329	260	23156
300	500	160	3321	5066	377	230	23160
320	540	176	3978	6186	446	230	23164
340	580	190	4411	6678	481	210	23168

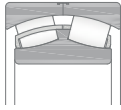

WOR

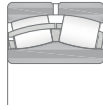

ECCS

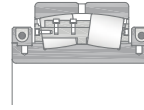

SSRB

Dimensions			Calculation factor e	Mass [kg]	Designation	
d [mm]	r _{1,2min}	r _{amax}			Cylindrical bore	Tapered bore
180	3	2,5	0,28	28	23136 2CZ	23136 K2CZ
(cont.)	3	2,5	0,37	34,5	24136 2CZ	-
	4	3	0,24	29	22236 2CZ	22236 K2CZ
190	3	2,5	0,3	35	23138 2CZ	23138 K2CZ
	3	2,5	0,4	43	24138 2CZ	-
	4	3	0,24	35	22238 2CZ	22238 K2CZ
200	2,1	2	0,22	22	23040 2CZ	23040 K2CZ
	3	2,5	0,3	43	23140 2CZ	23140 K2CZ
	3	2,5	0,4	53,5	24140 2CZ	-
	4	3	0,24	42	22240 2CZ	22240 K2CZ
	4	3	0,35	58	23240 2CZ	23240 K2CZ
220	2,1	2	0,15	12,5	23944 2CZ	-
	3	2,5	0,22	29	23044 2CZ	23044 K2CZ
	4	3	0,28	53,5	23144 2CZ	23144 K2CZ
	4	3	0,25	58	22244 2CZ	22244 K2CZ
	5	4	0,3	115	22344 2CZ	22344 K2CZ
240	3	2,5	0,21	32	23048 2CZ	23048 K2CZ
	4	3	0,28	66,5	23148 2CZ	23148 K2CZ
260	4	3	0,22	46	23052 2CZ	23052 K2CZ
	4	3	0,3	90,5	23152 2CZ	23152 K2CZ
280	5	4	0,28	97	23156 2CZ	23156 K2CZ
300	5	4	0,28	125	23160 2CZ	23160 K2CZ
320	5	4	0,3	165	23164 2CZ	23164 K2CZ
340	5	4	0,3	210	23168 2CZ	23168 K2CZ

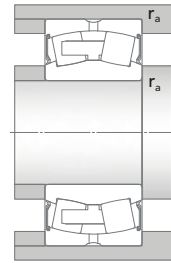
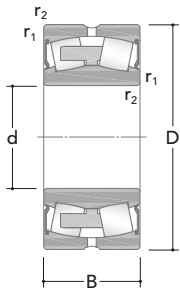

Sealed

Main dimensions			Basic load ratings		Fatigue load limit C_u	Speed ratings	Designation
d	D	B	Dynamic C	Static C_0		Limiting	Standard design
[mm]			[kN]			[rpm]	
360	600	192	4551	6922	488	190	23172
400	650	200	4785	7509	520	130	23180



WOR

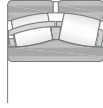

ECCS



SSRB

Dimensions			Calculation factor e	Mass	Designation	
d	$r_{1,2min}$	r_{amax}			Cylindrical bore	Tapered bore
[mm]				[kg]		
360	5	4	0,28	214	23172 2CZ	23172 K2CZ
400	6	5	0,28	255	23180 2CZ	23180 K2CZ

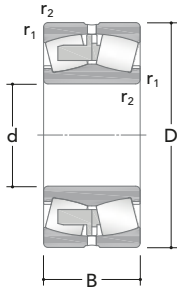

ROVSX

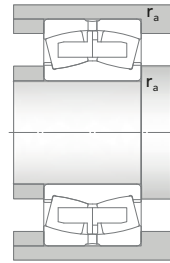

Main dimensions			Basic load ratings		Fatigue load limit C_u	Speed ratings		Designation
d	D	B	Dynamic C	Static C_0		Reference	Limiting	
[mm]			[kN]			[rpm]		Standard design
40	90	33	153	140	15	5400	7100	22308
45	100	36	187	183	19,6	4900	6300	22309
50	110	40	225	224	24	4300	5600	22310
55	120	43	279	279	29,9	3900	4800	22311
60	130	46	326	333	36,0	3600	4600	22312
65	140	48	361	353	37,3	3500	4300	22313
70	150	51	419	427	44,7	3100	3900	22314
75	160	55	470	474	47,9	3000	3800	22315
80	170	58	514	536	54,6	2800	3400	22316
85	180	60	586	617	60,7	2600	3400	22317
90	190	64	638	690	66,5	2400	3200	22318
95	200	67	693	762	73	2400	3000	22319
100	215	73	860	948	87,8	2200	2700	22320
	215	82,6	675	912	69,9	1800	2400	23320
110	240	80	985	1100	98,2	1800	2500	22322
	240	92,1	823	1100	87,6	1800	2300	23322
120	260	86	1030	1110	99,1	1850	2300	22324
	260	106	1000	1449	104	1500	2100	23324



KROVSX

Dimensions			Calculation factor e	Mass [kg]	Designation	
d [mm]	r _{1,2min}	r _{amax}			Cylindrical bore	Tapered bore
40	1,5	1,5	0,37	1,05	22308 ROVSX	22308 KROVSX
45	1,5	1,5	0,37	1,4	22309 ROVSX	22309 KROVSX
50	2	2	0,37	1,9	22310 ROVSX	22310 KROVSX
55	2	2	0,35	2,45	22311 ROVSX	22311 KROVSX
60	2,1	2	0,35	3,1	22312 ROVSX	22312 KROVSX
65	2,1	2	0,35	3,75	22313 ROVSX	22313 KROVSX
70	2,1	2	0,33	4,55	22314 ROVSX	22314 KROVSX
75	2,1	2	0,35	5,55	22315 ROVSX	22315 KROVSX
80	2,1	2	0,35	6,6	22316 ROVSX	22316 KROVSX
85	3	2,5	0,33	7,65	22317 ROVSX	22317 KROVSX
90	3	2,5	0,33	9,05	22318 ROVSX	22318 KROVSX
95	3	2,5	0,33	10,5	22319 ROVSX	22319 KROVSX
100	3	2,5	0,33	13,5	22320 ROVSX	22320 KROVSX
	3	2,5	0,43	15,5	23320 ROVSX	23320 KROVSX
110	3	2,5	0,33	18,5	22322 ROVSX	22322 KROVSX
	3	2,5	0,43	21,3	23322 ROVSX	23322 KROVSX
120	3	2,5	0,35	23	22324 ROVSX	22324 KROVSX
	3	2,5	0,45	29,1	23324 ROVSX	23324 KROVSX

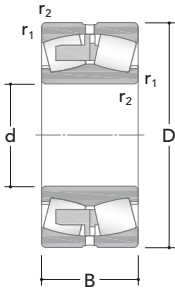

ROVSX

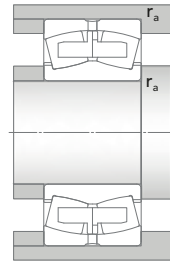

Main dimensions			Basic load ratings		Fatigue load limit C_u	Speed ratings		Designation
d	D	B	Dynamic C	Static C_0		Reference	Limiting	Standard design
[mm]			[kN]			[rpm]		
130	280	93	1178	1324	114	1650	2100	22326
	280	112	1160	1610	109	1450	1900	23326
140	300	102	1344	1540	130	1500	1900	22328
	300	118	1294	1812	124	1400	1700	23328
150	320	108	1523	1740	146	1500	1800	22330
	320	128	1470	2101	134	1350	1700	23330
160	340	114	1694	1950	160	1400	1700	22332
	340	136	1627	2336	153	1300	1700	23332
170	360	120	1894	2130	174	1300	1600	22334
180	380	126	2110	2420	191	1200	1500	22336
190	400	132	2267	2640	207	1100	1400	22338
	400	155	2156	3256	227	800	1200	23338
200	420	138	2450	2890	223	1100	1300	22340
	420	165	2493	3651	241	650	1150	23340
220	460	145	2834	3400	256	900	1200	22344
240	500	155	3194	3940	286	850	1150	22348

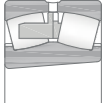

KROVSX

Dimensions			Calculation factor e	Mass [kg]	Designation	
d [mm]	r _{1,2min}	r _{amax}			Cylindrical bore	Tapered bore
130	4	3	0,35	29	22326 ROVSX	22327 KROVSX
	4	3	0,45	34,2	23326 ROVSX	23326 KROVSX
140	4	3	0,35	36,5	22328 ROVSX	22328 KROVSX
	4	3	0,43	40,9	23328 ROVSX	23328 KROVSX
150	4	3	0,35	43,5	22330 ROVSX	22330 KROVSX
	4	3	0,44	49,8	23330 ROVSX	23330 KROVSX
160	4	3	0,35	52	22332 ROVSX	22332 KROVSX
	4	3	0,44	61,3	23332 ROVSX	23332 KROVSX
170	4	3	0,33	61	22334 ROVSX	22334 KROVSX
180	4	3	0,35	71,5	22336 ROVSX	22336 KROVSX
190	5	4	0,35	82,5	22338 ROVSX	22338 KROVSX
	5	4	0,43	97,1	23338 ROVSX	23338 KROVSX
200	5	4	0,33	95	22340 ROVSX	22340 KROVSX
	5	4	0,43	108	23340 ROVSX	23340 KROVSX
220	5	4	0,31	120	22344 ROVSX	22344 KROVSX
240	5	4	0,31	155	22348 ROVSX	22348 KROVSX



Toroidal roller bearings

Toroidal roller bearings	526
Internal clearance.....	526
Misalignment	526
Axial displacement	529
Minimum load	529
Mounting prescription	529
Internal clearance and axial drive-up for TORB bearings with tapered bore.....	529
Designs and variants	531
Type J	531
Type V	531
Special designs and variants.....	531
Sealed type	531
Prefixes.....	532
Suffixes.....	532
Product tables.....	534
Product tables.....	552

Toroidal roller bearings

The RKB toroidal roller bearings (TORB) are single row pure radial roller bearings featuring slim symmetrical barrel rollers, properly profiled to grant an uniform stress distribution, as well as a proper roller/raceway contact.

This proper pressure distribution along all the roller profile allow to control rolling friction and working temperature, keeping them at their minimum values. Consequently the lube film gap remains stable and the lubricant ageing process is reduced also, improving the application reliability.

According to the internal design RKB TORB bearings are conceived to be mounted as non-locating bearings, since they can face the thermal expansion along the shaft. RKB TORB bearings are manufactured offering the highest load rating capacities, improved internal geometry, high quality materials and special heat treatments for superior performance.

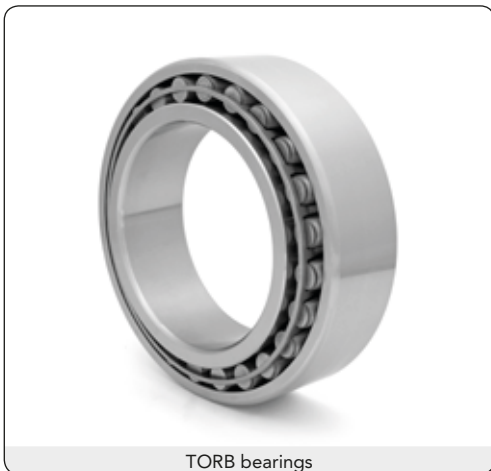

TORB bearings

Internal clearance

TORB bearings are produced as standard with Normal radial internal clearance CN, but they are also available with C2, C3, C4 and C5 radial internal clearance.

The radial internal clearance are reported for bearing with:

- cylindrical bore in the **Tab. 5 page 527**;
- tapered bore in the **Tab. 6 page 528**;

and they are valid only for bearing unmounted, unloaded and without any axial displacement of one ring in respect to the other one.

Axial displacement of one ring in respect to the other one reduces gradually the radial internal clearance, but if the axial displacement is not generated by the shaft thermal expansion, the radial internal clearance will be lightly affected (see the following paragraph "Axial displacement").

TORB bearings are often used together with the spherical roller bearings and their radial internal clearance is slightly larger than the spherical roller bearings of the same size. In order to achieve approximatively the same operational clearance value of spherical roller bearing of the same size, it is required only an axial displacement between one ring in respect to the other one of 6 - 8 % of TORB bearing width.

Misalignment

The internal design of the TORB bearings can accommodate a misalignment of approximatively 0.5° between inner ring and outer ring without affects negatively the bearing life. Greater misalignments increase the friction inside, so the bearing life will be negatively influenced. For additional information, please consult the RKB application engineering service.

In case of TORB bearing with brass cage guided on the inner ring, a misalignment value of 0.5° must not be exceeded. Also in application considered stationary, the value of the misalignment has to be reduced. Considering also that the axial displacement leads the rollers head to approach the ring faces, its reduction is suggested (please see the following axial displacement paragraph).

d [mm]		Radial internal clearance [µm]									
		C2		CN		C3		C4		C5	
over	incl.	min.	max.	min.	max.	min.	max.	min.	max.	min.	max.
24	30	15	35	30	50	45	60	60	80	75	95
30	40	20	40	35	55	55	75	70	95	90	120
40	50	25	45	45	65	65	85	85	110	105	140
50	65	30	55	50	80	75	105	100	140	135	175
65	80	40	70	65	100	95	125	120	165	160	210
80	100	50	85	80	120	120	160	155	210	205	260
100	120	60	100	100	145	140	190	185	245	240	310
120	140	75	120	115	170	165	215	215	280	280	350
140	160	85	140	135	195	195	250	250	325	320	400
160	180	95	155	150	220	215	280	280	365	360	450
180	200	105	175	170	240	235	310	305	395	390	495
200	225	115	190	185	265	260	340	335	435	430	545
225	250	125	205	200	285	280	370	365	480	475	605
250	280	135	225	220	310	305	410	405	520	515	655
280	315	150	240	235	330	330	435	430	570	570	715
315	355	160	260	255	360	360	485	480	620	620	790
355	400	175	280	280	395	395	530	525	675	675	850
400	450	190	310	305	435	435	580	575	745	745	930
450	500	205	335	335	475	475	635	630	815	810	1 015
500	560	220	360	360	520	510	690	680	890	890	1 110
560	630	240	400	390	570	560	760	750	980	970	1 220
630	710	260	440	430	620	610	840	830	1 080	1 070	1 340
710	800	300	500	490	680	680	920	920	1 200	1 200	1 480
800	900	320	540	530	760	750	1 020	1 010	1 330	1 320	1 660
900	1 000	370	600	590	830	830	1 120	1 120	1 460	1 460	1 830
1 000	1 120	410	660	660	930	930	1 260	1 260	1 640	1 640	2 040
1 120	1 250	450	720	720	1 020	1 020	1 380	1 380	1 800	1 800	2 240
1 250	1 400	490	800	800	1 130	1 130	1 510	1 510	1 970	1 970	2 460
1 400	1 600	570	890	890	1 250	1 250	1 680	1 680	2 200	2 200	2 740
1 600	1 800	650	1 010	1 010	1 390	1 390	1 870	1 870	2 430	2 430	3 000

Tab. 5 - Radial internal clearance of TORB bearings with cylindrical bore

d [mm]		Radial internal clearance [μm]									
		C2		CN		C3		C4		C5	
over	incl.	min.	max.	min.	max.	min.	max.	min.	max.	min.	max.
24	30	20	40	35	55	50	65	65	85	80	100
30	40	25	50	45	65	60	80	80	100	100	125
40	50	30	55	50	75	70	95	90	120	115	145
50	65	40	65	60	90	85	115	110	150	145	185
65	80	50	80	75	110	105	140	135	180	175	220
80	100	60	100	95	135	130	175	170	220	215	275
100	120	75	115	115	155	155	205	200	255	255	325
120	140	90	135	135	180	180	235	230	295	290	365
140	160	100	155	155	215	210	270	265	340	335	415
160	180	115	175	170	240	235	305	300	385	380	470
180	200	130	195	190	260	260	330	325	420	415	520
200	225	140	215	210	290	285	365	360	460	460	575
225	250	160	235	235	315	315	405	400	515	510	635
250	280	170	260	255	345	340	445	440	560	555	695
280	315	195	285	280	380	375	485	480	620	615	765
315	355	220	320	315	420	415	545	540	680	675	850
355	400	250	350	350	475	470	600	595	755	755	920
400	450	280	385	380	525	525	655	650	835	835	1 005
450	500	305	435	435	575	575	735	730	915	910	1 115
500	560	330	480	470	640	630	810	800	1 010	1 000	1 230
560	630	380	530	530	710	700	890	880	1 110	1 110	1 350
630	710	420	590	590	780	770	990	980	1 230	1 230	1 490
710	800	480	680	670	860	860	1 100	1 100	1 380	1 380	1 660
800	900	520	740	730	960	950	1 220	1 210	1 530	1 520	1 860
900	1 000	580	820	810	1 040	1 040	1 340	1 340	1 670	1 670	2 050
1 000	1 120	640	900	890	1 170	1 160	1 500	1 490	1 880	1 870	2 280
1 120	1 250	700	980	970	1 280	1 270	1 640	1 630	2 060	2 050	2 500
1 250	1 400	770	1 080	1 080	1 410	1 410	1 790	1 780	2 250	2 250	2 740
1 400	1 600	870	1 200	1 200	1 550	1 550	1 990	1 990	2 500	2 500	3 050
1 600	1 800	950	1 320	1 320	1 690	1 690	2 180	2 180	2 730	2 730	3 310

Tab. 6 - Radial internal clearance of TORB bearings with tapered bore

Axial displacement

The internal design of the TORB bearings can accommodate axial displacements between inner rings and outer rings, which can be generated by a thermal expansion or its deviation from a determinate position. Any misalignment or axial displacement reduces the bearing radial internal clearance. In order to accommodate the axial displacement it is necessary a defined space on both bearing sides and that the rollers must remaining inside the bearing raceways without touching eventual seals or locking rings.

With this axial displacement the bearing radial internal clearance decreases and it is important that it remains acceptable for the application. The maximum value of the axial displacement from the normal position of one ring relative to the other one has to be the lower among:

- the clearance reduction,
- the axial displacement of the rollers.

For additional information, please consult the RKB application engineering service.

Minimum load

A minimum radial load is requested for a TORB bearing, like for all ball and roller bearings, in order to guarantee the correct functioning condition, especially in particularly difficult working conditions: high speed, high acceleration and sudden changes of direction. In these operating conditions a sliding movement between the rollers and raceways can be generated by the inertial forces, influencing negatively the bearing life. Minimum radial load for TORB bearing with/without cage can be theoretically estimated using this formula:

$$\frac{F_{rm}}{C_0} > 0,023$$

Where:

- F_{rm} minimum radial load, [kN];
- C_0 basic static radial load, [kN].

Usually, the minimum radial load is reached or surpassed by the weight of the components supported by the bearing and the loads acting on it, otherwise supplementary radial load must be applied on the TORB bearing.

Mounting prescription

Since the RKB toroidal roller bearings are pure radial, both inner and outer rings have to be axially located on both sides. On the other hand during handling of toroidal roller bearings the rings and the rollers can be displaced from their nominal position, thus it is highly suggested to mount the bearings featuring housing and shaft in horizontal position, rotating one of the rings to rearrange the roller elements in their nominal position.

Internal clearance and axial drive-up for TORB bearings with tapered bore

Specific and recommended values for radial internal clearance reduction and axial drive-up can be provided upon request. However, in the following table (**Tab. 7 page 530**) is reported radial internal clearance reduction for general application, featuring solid steel shaft or hallow shaft with internal bore diameter lower than shaft diameter.

For additional information please consult the RKB application engineering services.

Bore diameter d [mm]		Radial internal clearance reduction [mm]		Minimum radial internal clearance after mounting		
				CN	C3	C4
over	incl.	min.	max.	min. [mm]	min. [mm]	min. [mm]
24	30	0,010	0,017	0,025	0,035	0,048
30	40	0,014	0,021	0,031	0,041	0,059
40	50	0,018	0,028	0,033	0,046	0,062
50	65	0,024	0,035	0,036	0,054	0,075
65	80	0,030	0,046	0,045	0,065	0,090
80	100	0,040	0,056	0,056	0,080	0,114
100	120	0,049	0,069	0,066	0,093	0,131
120	140	0,060	0,083	0,075	0,105	0,147
140	160	0,072	0,095	0,083	0,123	0,170
160	180	0,081	0,107	0,089	0,137	0,193
180	200	0,090	0,121	0,100	0,150	0,204
200	225	0,101	0,134	0,109	0,162	0,226
225	250	0,113	0,151	0,123	0,177	0,249
250	280	0,126	0,168	0,129	0,186	0,273
280	315	0,142	0,188	0,138	0,203	0,292
315	355	0,160	0,211	0,155	0,221	0,329
355	400	0,180	0,238	0,170	0,251	0,357
400	450	0,203	0,268	0,178	0,279	0,382
450	500	0,225	0,300	0,210	0,300	0,430
500	560	0,250	0,335	0,220	0,325	0,465
560	630	0,285	0,375	0,245	0,355	0,505
630	710	0,320	0,420	0,270	0,380	0,560
710	800	0,360	0,475	0,310	0,425	0,625
800	900	0,405	0,535	0,325	0,460	0,675
900	1000	0,450	0,605	0,360	0,490	0,735
1000	1120	0,505	0,670	0,385	0,545	0,820
1120	1250	0,565	0,750	0,410	0,580	0,880
1250	1400	0,630	0,840	0,450	0,640	0,940
1400	1600	0,720	0,940	0,480	0,685	1,050
1600	1800	0,810	1,070	0,510	0,705	1,110

Tab. 7 - Radial internal clearance reduction of toroidal roller bearings with tapered bore

Designs and variants

Type J

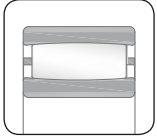

- Non-separable compact design
- Can be used only in a non-locating position
- Available with tapered and cylindrical bore
- Very high self-aligning and axial displacement properties
- The radial internal clearance depends on the rings axial relative position

Type V



- Non-separable compact design
- Can be used only in a non-locating position
- Available with tapered and cylindrical bore
- Very high self-aligning and axial displacement properties
- Full complement (cageless) design for increased load carrying capacities
- Reduced maximum rotational speed compared to caged design
- Asymmetrical permissible axial displacement (limited in snap ring side)

Special designs and variants

Sealed type

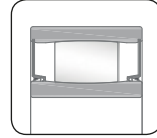

- Non-separable compact design
- Can be used only in a non-locating position
- High self-aligning and axial displacement properties
- Full complement (cageless) design
- Integral rubber seals on both bearing sides for harsh working conditions
- Supplied already filled with grease for maintenance free operations

Prefixes**Basic designation**

TORB	Toroidal roller bearing followed by size indication or drawing number
SB	Toroidal roller bearing followed by size indication or drawing number

Suffixes**Cage**

V	Full complement of rolling elements (without cage)
J	Pressed steel cage

Suffixes**External design**

2CS	NBR seal on both sides
FF	FKM seal on both sides
K	Tapered bore, taper 1:12
K30	Tapered bore, taper 1:30



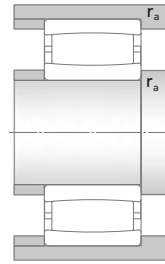
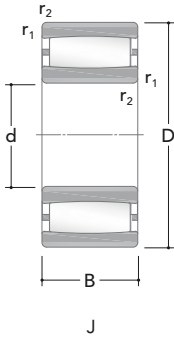

Main dimensions			Basic load ratings		Fatigue load limit C_u	Speed ratings		Designation Standard design
d	D	B	Dynamic C	Static C_0		Reference	Limiting	
[mm]			[kN]			[rpm]		
25	52	18	42,6	39,5	4,6	13300	16200	TORB 2205
	52	18	48,2	48,2	5,6	-	6200	TORB 2205
30	55	45	129	178	20,8	-	2800	TORB 6006
	62	20	67,4	60,8	7,1	11100	13500	TORB 2206
	62	20	74,7	70	8,3	-	5300	TORB 2206
35	72	23	81,3	79,2	9,4	9200	11600	TORB 2207
	72	23	92,8	94,7	11,2	-	4800	TORB 2207
40	62	22	73,6	99,2	11,9	-	3800	TORB 4908
	62	30	102	142	16,1	-	3100	TORB 5908
	62	40	118	180	21,2	-	2500	TORB 6908
	80	23	86,7	85,9	10,3	7900	9700	TORB 2208
	80	23	98,2	103	12,3	-	4000	TORB 2208
45	68	22	79	111	13,3	-	3400	TORB 4909
	68	30	106	162	18,4	-	2800	TORB 5909
	68	40	127	197	23,6	-	2300	TORB 6909
	85	23	89,5	91,4	10,8	7400	9800	TORB 2209
	85	23	102	109	13,0	-	3800	TORB 2209
50	72	22	83,6	125	14,6	-	3200	TORB 4910
	72	30	110	173	20,8	-	2500	TORB 5910
	72	40	135	220	25,7	-	2100	TORB 6910
	80	30	112	138	16,1	5700	6600	TORB 4010
	80	30	133	174	21,0	-	2700	TORB 4010
	90	23	95,1	99,1	11,9	7100	8500	TORB 2210
	90	23	111	122	14,3	-	3400	TORB 2210
55	80	25	103	151	17,8	-	2800	TORB 4911
	80	34	138	221	25,3	-	2300	TORB 5911
	80	45	173	295	35,5	-	1900	TORB 6911



V

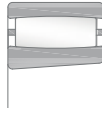

K/K30

Dimensions			Mass	Designation	
d	r _{1,2min}	r _{amax}		Cylindrical bore	Tapered bore
[mm]			[kg]		
25	1	1	0,17	TORB 2205	TORB 2205 K
	1	1	0,18	TORB 2205 V	TORB 2205 KV
30	1	1	0,49	TORB 6006 V	-
	1	1	0,28	TORB 2206	TORB 2206 K
	1	1	0,29	TORB 2206 V	TORB 2206 KV
35	1,1	1	0,44	TORB 2207	TORB 2207 K
	1,1	1	0,46	TORB 2207 V	TORB 2207 KV
40	0,6	0,6	0,25	TORB 4908 V	TORB 4908 K30V
	0,6	0,6	0,35	TORB 5908 V	-
	0,6	0,6	0,45	TORB 6908 V	-
	1,1	1	0,51	TORB 2208	TORB 2208 K
	1,1	1	0,53	TORB 2208 V	TORB 2208 KV
45	0,6	0,6	0,29	TORB 4909 V	TORB 4909 K30V
	0,6	0,6	0,41	TORB 5909 V	-
	0,6	0,6	0,53	TORB 6909 V	-
	1,1	1	0,56	TORB 2209	TORB 2209 K
	1,1	1	0,58	TORB 2209 V	TORB 2209 KV
50	0,6	0,6	0,29	TORB 4910 V	TORB 4910 K30V
	0,6	0,6	0,41	TORB 5910 V	-
	0,6	0,6	0,54	TORB 6910 V	-
	1	1	0,55	TORB 4010	TORB 4010 K30
	1	1	0,58	TORB 4010 V	TORB 4010 K30V
	1,1	1	0,6	TORB 2210	TORB 2210 K
	1,1	1	0,63	TORB 2210 V	TORB 2210 KV
55	1,5	1,5	0,42	TORB 4911 V	TORB 4911 K30V
	1	1	0,6	TORB 5911 V	-
	1	1	0,78	TORB 6911 V	-

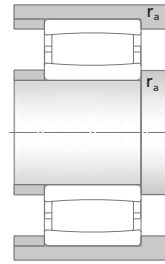
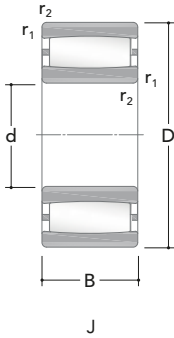

Main dimensions			Basic load ratings		Fatigue load limit C_u	Speed ratings		Designation Standard design
d	D	B	Dynamic C	Static C_0		Reference	Limiting	
[mm]			[kN]			[rpm]		
55	100	25	112	112	13,3	6400	8100	TORB 2211
(cont.)	100	25	128	132	15,8	-	3000	TORB 2211
60	85	25	109	169	19,7	-	2700	TORB 4912
	85	34	144	236	26,2	-	2100	TORB 5912
	110	28	140	154	17,9	5800	6800	TORB 2212
	110	28	160	188	22,6	-	2500	TORB 2212
65	90	25	113	179	20,9	-	2500	TORB 4913
	90	34	150	258	30,7	-	1900	TORB 5913
	90	45	191	352	41,9	-	1600	TORB 6913
	100	35	187	297	32,8	-	2200	TORB 4013
	120	31	173	179	21,3	5400	6800	TORB 2213
	120	31	197	215	25,6	-	2100	TORB 2213
70	100	30	157	160	28,0	-	2300	TORB 4914
	100	40	192	307	36,9	-	1800	TORB 5914
	100	54	259	449	48,0	-	1500	TORB 6914
	125	31	181	193	22,8	4900	6200	TORB 2214
	125	31	204	226	26,7	-	2200	TORB 2214
	150	51	395	428	49,2	3800	4500	TORB 2314
75	105	30	160	253	30,2	-	2100	TORB 4915
	105	40	200	321	38,0	-	1700	TORB 5915
	105	54	199	321	37,9	-	1700	TORB 6915
	115	40	201	340	40,5	-	1800	TORB 4015
	130	31	190	208	24,0	4900	5900	TORB 2215
	130	31	215	237	28,3	-	2000	TORB 2215
	160	55	416	464	52,1	3500	4200	TORB 2315
80	110	30	169	274	32,1	-	2000	TORB 4916
	110	40	204	341	39,7	-	1600	TORB 5916



V

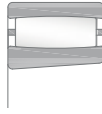

K/K30

Dimensions			Mass	Designation	
d	r _{1,2min}	r _{amax}		Cylindrical bore	Tapered bore
[mm]			[kg]		
55	1,5	1,5	0,8	TORB 2211	TORB 2211 K
(cont.)	1,5	1,5	0,82	TORB 2211 V	TORB 2211 KV
60	1	1	0,46	TORB 4912 V	TORB 4912 K30V
	1	1	0,64	TORB 5912 V	-
	1,5	1,5	1,1	TORB 2212	TORB 2212 K
	1,5	1,5	1,15	TORB 2212 V	TORB 2212 KV
65	1	1	0,5	TORB 4913 V	TORB 4913 K30V
	1	1	0,68	TORB 5913 V	-
	1	1	0,9	TORB 6913 V	-
	1,1	1	1,05	TORB 4013 V	TORB 4013 K30V
	1,5	1,5	1,45	TORB 2213	TORB 2213 K
	1,5	1,5	1,5	TORB 2213 V	TORB 2213 KV
70	1	1	0,78	TORB 4914 V	TORB 4914 K30V
	1	1	1	TORB 5914 V	-
	1	1	1,4	TORB 6914 V	-
	1,5	1,5	1,5	TORB 2214	TORB 2214 K
	1,5	1,5	1,55	TORB 2214 V	TORB 2214 KV
	2,1	2	4,3	TORB 2314	TORB 2314 K
75	1	1	0,82	TORB 4915 V	TORB 4915 K30V
	1	1	1,1	TORB 5915 V	-
	1	1	1,4	TORB 6915 V	-
	1,1	1	1,6	TORB 4015 V	TORB 4015 K30V
	1,5	1,5	1,6	TORB 2215	TORB 2215 K
	1,5	1,5	1,65	TORB 2215 V	TORB 2215 KV
	2,1	2	5,3	TORB 2315	TORB 2315 K
80	1	1	0,86	TORB 4916 V	TORB 4916 K30V
	1	1	1,15	TORB 5916 V	-

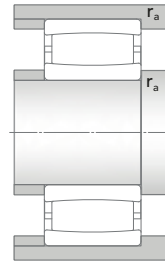
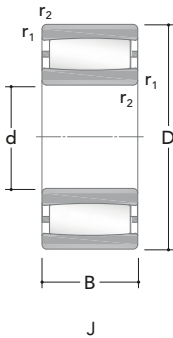

Main dimensions			Basic load ratings		Fatigue load limit C_u	Speed ratings		Designation Standard design
d	D	B	Dynamic C	Static C_0		Reference	Limiting	
[mm]			[kN]			[rpm]		
80	140	33	212	246	28,8	4200	5300	TORB 2216
(cont.)	140	33	246	300	33,8	-	1800	TORB 2216
	170	58	495	550	60,0	3500	4100	TORB 2316
85	120	35	217	351	39,7	-	1800	TORB 4917
	120	46	265	463	52,2	-	1500	TORB 5917
	150	36	264	314	35,9	3900	5000	TORB 2217
	150	36	307	388	43,2	-	1600	TORB 2217
	180	60	523	599	64,1	3200	3800	TORB 2317
90	125	35	181	313	35,7	-	1800	TORB 4918
	125	46	187	324	37,6	2700	3500	TORB 5918
	125	46	217	399	45,6	-	1400	TORB 5918
	160	40	312	373	41,9	3800	4700	TORB 2218
	160	40	352	433	47,5	-	1400	TORB 2218
	190	64	588	690	74,0	2900	3500	TORB 2318
95	170	43	316	373	41,1	3900	4800	TORB 2219
	200	67	587	683	73,5	2900	3600	TORB 2319
100	140	40	233	447	50,5	-	1600	TORB 4920
	140	54	362	636	68,4	-	1200	TORB 5920
	150	50	345	520	58,5	-	1300	TORB 4020
	150	67	492	860	95,6	-	1000	TORB 5020
	165	52	462	651	71,4	-	1200	TORB 3120
	165	65	460	653	71,2	-	1200	TORB 4120
	180	46	406	464	69,6	3500	4300	TORB 2220
	215	73	774	869	26,2	2600	3200	TORB 2320
110	170	45	341	471	51,0	3200	4000	TORB 3022
	170	60	416	653	69,7	2500	3100	TORB 4022
	170	60	490	800	85,0	-	1100	TORB 4022



V

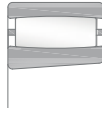

K/K30

Dimensions			Mass	Designation	
d	r _{1,2min}	r _{amax}		Cylindrical bore	Tapered bore
[mm]			[kg]		
80	2	2	2,05	TORB 2216	TORB 2216 K
(cont.)	2	2	2,15	TORB 2216 V	TORB 2216 KV
	2,1	2	6,3	TORB 2316	TORB 2316 K
85	1,1	1	1,3	TORB 4917 V	TORB 4917 K30V
	1,1	1	1,7	TORB 5917 V	-
	2	2	2,65	TORB 2217	TORB 2217 K
	2	2	2,8	TORB 2217 V	TORB 2217 KV
	3	2,5	7,4	TORB 2317	TORB 2317 K
90	1,1	1	1,3	TORB 4918 V	TORB 4918 K30V
	1,1	1	1,75	TORB 5918	-
	1,1	1	1,75	TORB 5918 V	-
	2	2	3,3	TORB 2218	TORB 2218 K
	2	2	3,45	TORB 2218 V	TORB 2218 KV
	3	2,5	8,65	TORB 2318	TORB 2318 K
95	2,1	2	4,1	TORB 2219	TORB 2219 K
	3	2,5	10	TORB 2319	TORB 2319 K
100	1,1	1	2,05	TORB 4920 V	TORB 4920 K30V
	1,1	1	2,7	TORB 5920 V	-
	1,5	1,5	3,05	TORB 4020 V	TORB 4020 K30V
	1,5	1,5	4,3	TORB 5020 V	-
	2	2	4,45	TORB 3120 V	TORB 3120 KV
	2	2	5,3	TORB 4120 V	TORB 4120 K30V
	2,1	2	4,95	TORB 2220	TORB 2220 K
	3	2,5	12,5	TORB 2320	TORB 2320 K
110	2	2	3,6	TORB 3022	TORB 3022 K
	2	2	5,3	TORB 4022	TORB 4022 K30
	2	2	5,2	TORB 4022 V	TORB 4022 K30V

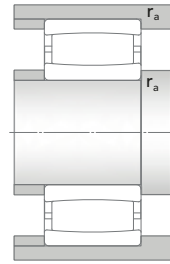
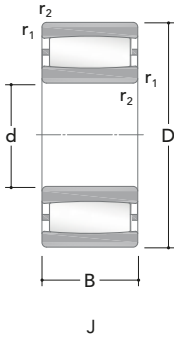

Main dimensions			Basic load ratings		Fatigue load limit C_u	Speed ratings		Designation Standard design
d	D	B	Dynamic C	Static C_0		Reference	Limiting	
[mm]			[kN]			[rpm]		
110	180	69	652	984	102	-	800	TORB 4122
(cont.)	200	53	510	609	64,6	3300	3900	TORB 2222
120	180	46	364	520	53,9	3000	3800	TORB 3024
	180	46	418	628	66,2	-	1200	TORB 3024
	180	60	419	630	92,4	-	1200	TORB 4024
	180	60	514	870	48,2	-	1200	TORB 4024
	200	80	758	1090	112	-	700	TORB 4124
	215	58	591	702	69,6	2800	3600	TORB 2224
	215	76	734	968	99,0	2400	2800	TORB 3224
130	200	52	381	577	58,5	2800	3400	TORB 3026
	200	69	603	913	92,1	2200	2500	TORB 4026
	200	69	702	1110	113	-	800	TORB 4026
	210	80	727	1090	111	-	700	TORB 4126
	230	64	707	922	92,3	2700	3300	TORB 2226
140	210	53	480	727	72,7	2700	3000	TORB 3028
	210	69	723	1210	121	-	700	TORB 4028
	225	85	762	1180	115	-	700	TORB 4128
	250	68	801	1040	101	2300	2900	TORB 2228
150	225	56	519	833	79,9	2300	2800	TORB 3030
	225	56	564	955	93,5	-	900	TORB 3030
	225	75	751	1310	128	-	700	TORB 4030
150	250	80	860	1270	122	2000	2500	TORB 3130
	250	100	1180	1840	176	-	400	TORB 4130
	270	73	949	1200	115	2400	2800	TORB 2230
160	240	60	587	978	93,2	2200	2600	TORB 3032
	240	80	736	1130	109	1600	2200	TORB 4032



V

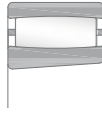

K/K30

Dimensions			Mass	Designation	
d	r _{1,2min}	r _{amax}		Cylindrical bore	Tapered bore
[mm]			[kg]		
110	2	2	7,1	TORB 4122 V	TORB 4122 K30V
(cont.)	2,1	2	7	TORB 2222	TORB 2222 K
120	2	2	3,95	TORB 3024	TORB 3024 K
	2	2	4,1	TORB 3024 V	TORB 3024 KV
	2	2	5,05	TORB 4024	TORB 4024 K30
	2	2	5,55	TORB 4024 V	TORB 4024 K30V
	2	2	10	TORB 4124 V	TORB 4124 K30V
	2,1	2	8,65	TORB 2224	TORB 2224 K
	2,1	2	12	TORB 3224	TORB 3224 K
130	2	2	5,9	TORB 3026	TORB 3026 K
	2	2	7,85	TORB 4026	TORB 4026 K30
	2	2	8,15	TORB 4026 V	TORB 4026 K30V
	2	2	10,5	TORB 4126 V	TORB 4126 K30V
	3	2,5	11,5	TORB 2226	TORB 2226 K
140	2	2	6,3	TORB 3028	TORB 3028 K
	2	2	8,6	TORB 4028 V	TORB 4028 K30V
	2,1	2	12,5	TORB 4128 V	TORB 4128 K30V
	3	2,5	14	TORB 2228	TORB 2228 K
150	2,1	2	8,45	TORB 3030	TORB 3030 K
	2,1	2	8	TORB 3030 V	TORB 3030 KV
	2,1	2	10,5	TORB 4030 V	TORB 4030 K30V
150	2,1	2	15,5	TORB 3130	TORB 3130 K
	2,1	2	20	TORB 4130 V	TORB 4130 K30V
	3	2,5	18	TORB 2230	TORB 2230 K
160	2,1	2	9,6	TORB 3032	TORB 3032 K
	2,1	2	12,5	TORB 4032	TORB 4032 K30

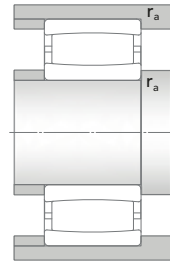
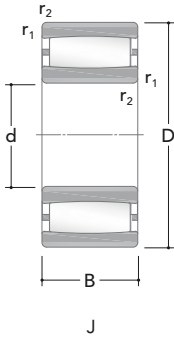

Main dimensions			Basic load ratings		Fatigue load limit C_u	Speed ratings		Designation Standard design
d	D	B	Dynamic C	Static C_0		Reference	Limiting	
[mm]			[kN]			[rpm]		
160	240	80	895	1440	137	-	500	TORB 4032
(cont.)	270	86	967	1380	130	1900	2300	TORB 3132
	270	109	1410	2150	201	-	300	TORB 4132
	290	104	1330	1790	172	1800	2100	TORB 3232
170	260	67	727	1140	99	2100	2500	TORB 3034
	260	90	1110	1850	174	-	500	TORB 4034
	280	88	1010	1450	138	1800	2300	TORB 3134
	280	109	1490	2270	209	-	300	TORB 4134
	310	86	1240	1610	145	1900	2300	TORB 2234
180	280	74	846	1310	120	1900	2300	TORB 3036
	280	100	1290	2110	197	-	400	TORB 4036
	300	96	1200	1720	157	1700	2200	TORB 3136
	300	118	1700	2660	238	-	200	TORB 4136
	320	112	1480	2190	194	1500	1800	TORB 3236
190	290	75	899	1450	133	1700	2200	TORB 3038
	290	100	1310	2300	210	-	300	TORB 4038
	320	104	1630	2500	192	-	200	TORB 3138
	320	128	1970	3130	277	-	100	TORB 4138
	340	92	1310	1700	155	1700	2100	TORB 2238
200	310	82	1080	1700	153	1700	2100	TORB 3040
	310	109	1560	2600	231	-	200	TORB 4040
	340	112	1560	2290	196	1500	1800	TORB 3140
	340	140	2260	3610	318	-	100	TORB 4140
220	340	90	1280	2020	178	1600	1900	TORB 3044
	340	118	1860	3230	277	-	200	TORB 4044
	370	120	1820	2840	245	1400	1600	TORB 3144
	400	108	1930	2490	209	1500	1800	TORB 2244



V

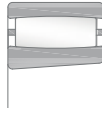

K/K30

Dimensions			Mass	Designation	
d	r _{1,2min}	r _{amax}		Cylindrical bore	Tapered bore
[mm]			[kg]		
160	2,1	2	13	TORB 4032 V	TORB 4032 K30V
(cont.)	2,1	2	21,5	TORB 3132	TORB 3132 K
	2,1	2	26	TORB 4132 V	TORB 4132 K30V
	3	2,5	29,5	TORB 3232	TORB 3232 K
170	2,1	2	12,5	TORB 3034	TORB 3034 K
	2,1	2	17,5	TORB 4034 V	TORB 4034 K30V
	2,1	2	21	TORB 3134	TORB 3134 K
	2,1	2	27	TORB 4134 V	TORB 4134 K30V
	4	3	28	TORB 2234	TORB 2234 K
180	2,1	2	17	TORB 3036	TORB 3036 K
	2,1	2	23,5	TORB 4036 V	TORB 4036 K30
	3	2,5	26,5	TORB 3136	TORB 3136 K
	3	2,5	34,5	TORB 4136 V	TORB 4136 K30
	4	3	38	TORB 3236	TORB 3236 K
190	2,1	2	17,5	TORB 3038	TORB 3038 K
	2,1	2	24	TORB 4038 V	TORB 4038 K30V
	3	2,5	34,5	TORB 3138 V	TORB 3138 KV
	3	2,5	43	TORB 4138 V	TORB 4138 K30V
	4	3	34,5	TORB 2238	TORB 2238 K
200	2,1	2	22,5	TORB 3040	TORB 3040 K
	2,1	2	30,5	TORB 4040 V	TORB 4040 K30V
	3	2,5	41	TORB 3140	TORB 3140 K
	3	2,5	54	TORB 4140 V	-
220	3	2,5	29,5	TORB 3044	TORB 3044 K
	3	2,5	40	TORB 4044 V	TORB 4044 K30V
	4	3	52	TORB 3144	TORB 3144 K
	4	3	57,5	TORB 2244	TORB 2244 K

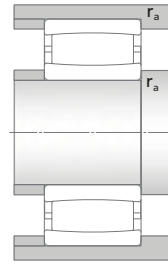
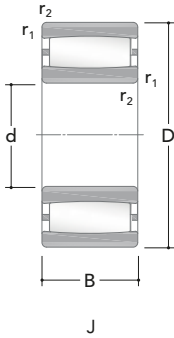

Main dimensions			Basic load ratings		Fatigue load limit C_u	Speed ratings		Designation
d	D	B	Dynamic C	Static C_0		Reference	Limiting	
[mm]			[kN]			[rpm]		
240	360	92	1280	2110	183	1500	1800	TORB 3048
240	400	128	2240	3400	282	1300	1500	TORB 3148
260	400	104	1700	2810	227	1200	1600	TORB 3052
	440	144	2540	4010	328	1100	1300	TORB 3152
280	420	106	1790	3080	252	1200	1400	TORB 3056
	460	146	2790	4490	356	1100	1200	TORB 3156
300	460	118	2110	3740	291	1100	1300	TORB 3060
	460	160	2830	4830	394	900	1060	TORB 4060
	500	160	3120	5100	400	910	1140	TORB 3160
320	480	121	2210	3960	299	970	1250	TORB 3064
	540	176	4000	6190	480	900	1160	TORB 3164
340	520	133	2820	4970	377	910	1170	TORB 3068
	580	190	4770	7390	549	820	990	TORB 3168
360	480	90	1690	3220	247	1020	1260	TORB 3972
	540	134	2780	4900	368	920	1140	TORB 3072
	600	192	4820	7950	589	780	980	TORB 3172
380	520	106	2060	3940	300	940	1140	TORB 3976
	560	135	2880	5100	373	880	1080	TORB 3076
	620	194	4300	7110	510	760	880	TORB 3176
400	540	106	2040	3980	291	880	1160	TORB 3980
	600	148	3510	6160	453	820	970	TORB 3080
	650	200	4630	8260	588	680	860	TORB 3180



V

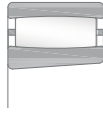

K/K30

Dimensions			Mass	Designation	
d	r _{1,2min}	r _{amax}		Cylindrical bore	Tapered bore
[mm]			[kg]		
240	3	2,5	32	TORB 3048	TORB 3048 K
240	4	3	64	TORB 3148	TORB 3148 K
260	4	3	47	TORB 3052	TORB 3052 K
	4	3	88	TORB 3152	TORB 3152 K
280	4	3	50,5	TORB 3056	TORB 3056 K
	5	4	94,5	TORB 3156	TORB 3156 K
300	4	3	72	TORB 3060	TORB 3060 K
	4	3	95,5	TORB 4060	TORB 4060 K30
	5	4	125	TORB 3160	TORB 3160 K
320	4	3	78	TORB 3064	TORB 3064 K
	5	4	164	TORB 3164	TORB 3164 K
340	5	4	100	TORB 3068	TORB 3068 K
	5	4	205	TORB 3168	TORB 3168 K
360	3	2,5	45	TORB 3972	TORB 3972 K
	5	4	106	TORB 3072	TORB 3072 K
	5	4	220	TORB 3172	TORB 3172 K
380	4	3	66	TORB 3976	TORB 3976 K
	5	4	110	TORB 3076	TORB 3076 K
	5	4	243	TORB 3176	TORB 3176 K
400	4	3	68,5	TORB 3980	TORB 3980 K
	5	4	145	TORB 3080	TORB 3080 K
	6	5	258	TORB 3180	TORB 3180 K

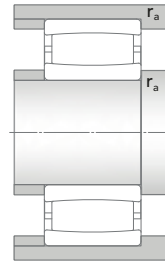
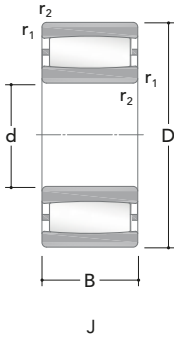

Main dimensions			Basic load ratings		Fatigue load limit C_u	Speed ratings		Designation Standard design
d	D	B	Dynamic C	Static C_0		Reference	Limiting	
[mm]			[kN]			[rpm]		
420	560	106	2100	4220	312	820	1080	TORB 3984
	620	150	3650	6340	459	800	980	TORB 3084
	700	224	5780	10330	725	650	790	TORB 3184
440	600	118	2530	5270	377	810	980	TORB 3988
	650	157	3640	6350	454	770	880	TORB 3088
	720	226	6540	11360	783	620	750	TORB 3188
	720	280	7260	12740	900	490	590	TORB 4188
460	620	118	2610	5290	376	820	970	TORB 3992
	680	163	3890	7450	523	700	840	TORB 3092
460	760	240	6650	11870	807	610	710	TORB 3192
	760	300	8430	14760	1020	460	570	TORB 4192
480	650	128	3020	6010	425	730	880	TORB 3996
	700	165	3890	7730	535	650	800	TORB 3096
	790	248	6710	12440	834	580	660	TORB 3196
500	670	128	3070	6270	432	680	860	TORB 39/500
	720	167	4130	8160	566	640	790	TORB 30/500
	830	264	7260	12680	851	510	660	TORB 31/500
	830	325	9590	17410	1160	430	490	TORB 41/500
530	710	136	3410	7050	483	640	790	TORB 39/530
	780	185	4910	9330	636	610	700	TORB 30/530
	870	272	8610	15580	1021	490	600	TORB 31/530
560	750	140	3510	7320	492	590	750	TORB 39/560
	820	195	5460	10840	720	510	660	TORB 30/560
	920	280	8840	16240	1044	470	600	TORB 31/560
	920	355	10030	19500	1277	380	450	TORB 41/560



V

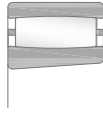

K/K30

Dimensions			Mass	Designation	
d	r _{1,2min}	r _{amax}		Cylindrical bore	Tapered bore
[mm]			[kg]		
420	4	3	72	TORB 3984	TORB 3984 K
	5	4	150	TORB 3084	TORB 3084 K
	6	5	355	TORB 3184	TORB 3184 K
440	4	3	99	TORB 3988	TORB 3988 K
	6	5	190	TORB 3088	TORB 3088 K
	6	5	385	TORB 3188	TORB 3188 K
	6	5	471	TORB 4188	TORB 4188 K30
460	4	3	100	TORB 3992	TORB 3992 K
	6	5	205	TORB 3092	TORB 3092 K
460	7,5	6	435	TORB 3192	TORB 3192 K
	7,5	6	571	TORB 4192	TORB 4192 K30
480	5	4	120	TORB 3996	TORB 3996 K
	6	5	215	TORB 3096	TORB 3096 K
	7,5	6	523	TORB 3196	TORB 3196 K
500	5	4	125	TORB 39/500	TORB 39/500 K
	6	5	225	TORB 30/500	TORB 30/500 K
	7,5	6	560	TORB 31/500	TORB 31/500 K
	7,5	6	710	TORB 41/500	TORB 41/500 K30
530	5	4	150	TORB 39/530	TORB 39/530 K
	6	5	300	TORB 30/530	TORB 30/530 K
	7,5	6	636	TORB 31/530	TORB 31/530 K
560	5	4	175	TORB 39/560	TORB 39/560 K
	6	5	350	TORB 30/560	TORB 30/560 K
	7,5	6	789	TORB 31/560	TORB 31/560 K
	7,5	6	1010	TORB 41/560	TORB 41/560 K30

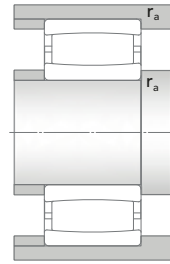
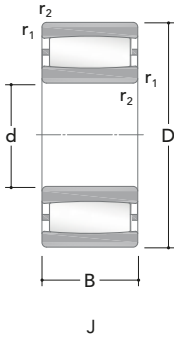

Main dimensions			Basic load ratings		Fatigue load limit C_u	Speed ratings		Designation Standard design
d	D	B	Dynamic C	Static C_0		Reference	Limiting	
[mm]			[kN]			[rpm]		
600	800	150	3860	8750	573	580	670	TORB 39/600
	870	200	6150	12040	772	480	620	TORB 30/600
	980	300	9860	17760	1152	440	530	TORB 31/600
	980	375	12460	22880	1431	330	400	TORB 41/600
630	850	165	4530	9860	627	540	620	TORB 39/630
	920	212	6580	12750	807	470	600	TORB 30/630
	1030	315	11480	20650	1299	390	500	TORB 31/630
670	900	170	4730	11040	695	480	550	TORB 39/670
	980	230	7930	16180	1007	440	530	TORB 30/670
	1090	336	11480	20850	1303	390	450	TORB 31/670
710	950	180	5840	12430	784	450	560	TORB 39/710
	1030	236	8450	16970	1071	410	500	TORB 30/710
	1030	315	10290	21410	1332	320	380	TORB 40/710
	1150	345	12930	25370	1538	340	430	TORB 31/710
750	1000	185	5880	13320	820	420	500	TORB 39/750
	1000	250	7580	17160	1069	330	430	TORB 49/750
750	1090	250	9190	19060	1137	380	480	TORB 30/750
	1220	365	15440	30040	1800	330	400	TORB 31/750
800	1060	195	6150	14320	880	370	470	TORB 39/800
	1150	258	8930	19120	1151	370	420	TORB 30/800
	1280	375	15140	26480	1529	290	350	TORB 31/800
850	1120	200	7200	16130	970	360	420	TORB 39/850
	1220	272	11150	24050	1444	320	410	TORB 30/850
	1360	400	16250	33460	1902	280	340	TORB 31/850
900	1180	206	8060	18240	1091	370	400	TORB 39/900



V

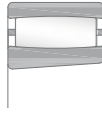

K/K30

Dimensions			Mass	Designation	
d	r _{1,2min}	r _{amax}		Cylindrical bore	Tapered bore
[mm]			[kg]		
600	5	4	215	TORB 39/600	TORB 39/600 K
	6	5	395	TORB 30/600	TORB 30/600 K
	7,5	6	929	TORB 31/600	TORB 31/600 K
	7,5	6	1150	TORB 41/600	TORB 41/600 K30
630	6	5	275	TORB 39/630	TORB 39/630 K
	7,5	6	470	TORB 30/630	TORB 30/630 K
	7,5	6	1090	TORB 31/630	TORB 31/630 K
670	6	5	315	TORB 39/670	TORB 39/670 K
	7,5	6	590	TORB 30/670	TORB 30/670 K
	7,5	6	1300	TORB 31/670	TORB 31/670 K
710	6	5	360	TORB 39/710	TORB 39/710 K
	7,5	6	655	TORB 30/710	TORB 30/710 K
	7,5	6	865	TORB 40/710	TORB 40/710 K30
	9,5	8	1470	TORB 31/710	TORB 31/710 K
750	6	5	410	TORB 39/750	TORB 39/750 K
	6	5	604	TORB 49/750	TORB 49/750 K
750	7,5	6	838	TORB 30/750	TORB 30/750 K
	9,5	8	1810	TORB 31/750	TORB 31/750 K
800	6	5	480	TORB 39/800	TORB 39/800 K
	7,5	6	941	TORB 30/800	TORB 30/800 K
	9,5	8	2030	TORB 31/800	TORB 31/800 K
850	6	5	540	TORB 39/850	TORB 39/850 K
	7,5	6	1110	TORB 30/850	TORB 30/850 K
	12	10	2450	TORB 31/850	TORB 31/850 K
900	6	5	633	TORB 39/900	TORB 39/900 K

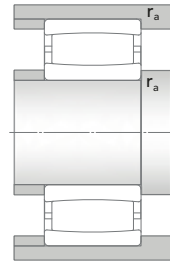
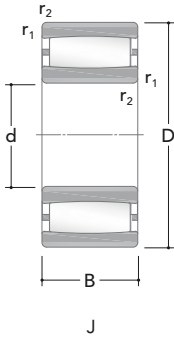

Main dimensions			Basic load ratings		Fatigue load limit C_u	Speed ratings		Designation
d	D	B	Dynamic C	Static C_0		Reference	Limiting	Standard design
[mm]			[kN]			[rpm]		
900	1280	280	12220	26310	1541	290	360	TORB 30/900
(cont.)								
950	1250	224	9100	21750	1263	290	390	TORB 39/950
	1360	300	12860	28070	1616	270	330	TORB 30/950
1000	1420	308	13200	30000	1683	270	320	TORB 30/1000
	1580	462	19590	45060	2524	220	260	TORB 31/1000
1060	1400	250	10690	25790	1442	250	320	TORB 39/1060
1180	1540	272	13020	33240	1814	230	260	TORB 39/1180
1250	1750	375	21540	48470	2525	180	210	TORB 30/1250
1320	1600	280	10310	30270	1612	200	230	TORB 48/1320
1500	1950	335	18900	47260	2353	130	180	TORB 39/1500



V

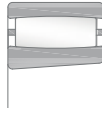

K/K30

Dimensions			Mass	Designation	
d	r _{1,2min}	r _{amax}		Cylindrical bore	Tapered bore
[mm]			[kg]		
900	7,5	6	1200	TORB 30/900	TORB 30/900 K
(cont.)					
950	7,5	6	784	TORB 39/950	TORB 39/950 K
	7,5	6	1480	TORB 30/950	TORB 30/950 K
1000	7,5	6	1680	TORB 30/1000	TORB 30/1000 K
	12	10	3800	TORB 31/1000	TORB 31/1000 K
1060	7,5	6	1120	TORB 39/1060	TORB 39/1060 K
1180	7,5	6	1400	TORB 39/1180	TORB 39/1180 K
1250	9,5	8	2980	TORB 30/1250	TORB 30/1250 K
1320	6	5	1250	TORB 48/1320	TORB 48/1320 K30
1500	9,5	8	2710	TORB 39/1500	TORB 39/1500 K

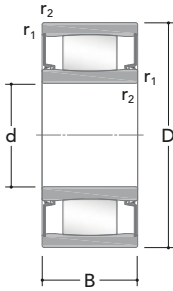

Sealed

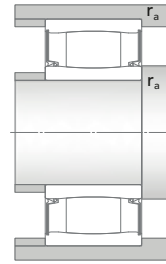

Main dimensions			Basic load ratings		Fatigue	Speed ratings	Designation
d	D	B	Dynamic C	Static C ₀	load limit C _u	Limiting	Standard design
[mm]			[kN]			[rpm]	
50	72	40	144	220	25	182	TORB 6910 V2CS
65	100	35	100	180	19,6	137	TORB 4013 V2CS
75	105	54	200	325	37,5	120	TORB 6915 V2CS
	115	40	147	192	23,3	117	TORB 4015 V2CS
90	125	46	222	399	44	100	TORB 5918 V2CS
100	150	50	313	450	50	81	TORB 4020 V2CS
	165	65	470	649	70	82	TORB 4120 V2CS
110	170	60	407	573	64	77	TORB 4022 V2CS
	180	69	515	738	72	72	TORB 4122 V2CS
120	180	60	426	634	68	72	TORB 4024 V2CS
	200	80	738	1010	99	65	TORB 4124 V2CS
130	200	69	550	825	86	64	TORB 4026 V2CS
	210	80	780	1098	108	64	TORB 4126 V2CS
140	210	69	576	900	88	60	TORB 4028 V2CS
	225	85	788	1200	116	58	TORB 4128 V2CS
150	225	75	597	984	91	58	TORB 4030 V2CS
	250	100	1257	1850	174	55	TORB 4130 V2CS
160	240	80	662	1144	100	55	TORB 4032 V2CS
	270	109	1475	2160	200	48	TORB 4132 V2CS
170	260	90	994	1614	152	49	TORB 4034 V2CS
	280	109	1499	2260	210	48	TORB 4134 V2CS

Dimensions			Mass	Designation
d	r _{1,2min}	r _{amax}		Standard design
[mm]			[kg]	
50	0,6	0,6	0,56	TORB 6910 V2CS
65	1,1	1	1,05	TORB 4013 V2CS
75	1	1	1,4	TORB 6915 V2CS
	1,1	1	1,4	TORB 4015 V2CS
90	1,1	1	1,75	TORB 5918 V2CS
100	1,5	1,5	2,9	TORB 4020 V2CS
	2	2	5,2	TORB 4120 V2CS
110	2	2	4,6	TORB 4022 V2CS
	2	2	6,6	TORB 4122 V2CS
120	2	2	5,1	TORB 4024 V2CS
	2	2	9,7	TORB 4124 V2CS
130	2	2	7,5	TORB 4026 V2CS
	2	2	10,5	TORB 4126 V2CS
140	2	2	7,9	TORB 4028 V2CS
	2,1	2	12,5	TORB 4128 V2CS
150	2,1	2	10	TORB 4030 V2CS
	2,1	2	20,5	TORB 4130 V2CS
160	2,1	2	12	TORB 4032 V2CS
	2,1	2	26	TORB 4132 V2CS
170	2,1	2	17	TORB 4034 V2CS
	2,1	2	27	TORB 4134 V2CS

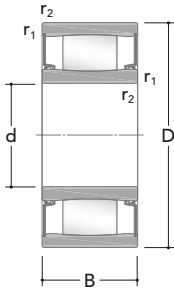

Sealed

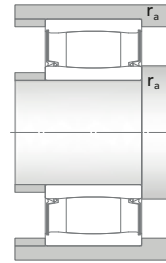

Main dimensions			Basic load ratings		Fatigue	Speed ratings	Designation
d	D	B	Dynamic C	Static C ₀	load limit C _u	Limiting	Standard design
[mm]			[kN]			[rpm]	
180	280	100	1320	2099	195	46	TORB 4036 V2CS
	300	118	1725	2808	231	41	TORB 4136 V2CS
190	290	100	1343	2413	196	43	TORB 4038 V2CS
	320	128	2122	3130	277	41	TORB 4138 V2CS
200	310	109	1597	2630	234	41	TORB 4040 V2CS
	340	140	2313	3723	309	39	TORB 4140 V2CS

Dimensions			Mass	Designation
d	r _{1,2min}	r _{amax}		Standard design
[mm]			[kg]	
180	2,1	2	23,5	TORB 4036 V2CS
	3	2,5	35	TORB 4136 V2CS
190	2,1	2	24,5	TORB 4038 V2CS
	3	2,5	43,5	TORB 4138 V2CS
200	2,1	2	31	TORB 4040 V2CS
	3	2,5	54,5	TORB 4140 V2CS



Thrust bearings

Thrust ball bearings	560
Single direction thrust ball bearings.....	560
Misalignment.....	560
Minimum load	560
Designs and variants	562
Type 51M.....	562
Variant 53M+U	562
Prefixes.....	563
Suffixes.....	563
Product tables.....	564
Double direction thrust ball bearings.....	588
Minimum load	588
Designs and variants	589
Type 52M.....	589
Product tables.....	590
Cylindrical roller thrust bearings	594
Single direction cylindrical roller thrust bearings	594
Misalignment.....	594
Minimum load	594
Designs and variants	596
Type 81M.....	596
Type TCRBU	596
Type 89M.....	596
Prefixes.....	597
Suffixes.....	597
Product tables.....	598
Double direction cylindrical roller thrust bearings.....	614
Misalignment.....	614
Minimum load	614
Designs and variants	615
Type WS+GS.....	615
Tapered roller thrust bearings	616
Single direction tapered roller thrust bearings	616

Misalignment.....	616
Minimum load	617
Designs and variants	618
Type TK ₁	618
Type TK ₂	618
Type TK ₃	618
Type TK ₄	618
Type TKSD ₁	619
Type TKSD ₂	619
Type TKSD ₃	619
Type TKSD ₄	619
Type TKSD ₅	619
Suffixes.....	620
Prefixes.....	620
Product tables.....	622
Double direction tapered roller thrust bearings.....	630
Misalignment	630
Minimum load	630
Designs and variants	631
Type TTK ₁	631
Type TTK ₂	631
Type TTK _{SP}	631
Product tables.....	632
Spherical roller thrust bearings	636
Single direction spherical roller thrust bearings.....	636
Misalignment.....	637
Minimum load	637
Lubrication and mounting	637
Designs and variants	638
Type EM.....	638
Type EMB	638
Type EM _{EVO}	638
Type EJ	638
Suffixes.....	639
Product tables.....	640

RKB
BEARING INDUSTRIES
SWITZERLAND

Thrust ball bearings

The thrust ball bearings (TBBs) manufactured by RKB are designed to support high axial loads and, in some cases, even moderate radial loads. The manufacturing program includes single and double direction TBBs with flat or spherical housing washers to meet any requirements in various industrial applications. Thanks to the improved internal geometry and the use of the most suitable raw materials, all RKB TBBs attain the highest axial load ratings and the best reliability.

Depending on application requirements, RKB Bainite Hardening Treatment (HB) and High Temperature Dimensional Stabilization (S) can be applied on bearing rings and rolling elements. The bearing dimensional and running accuracy conforms to ISO/ABMA/GOST specifications.

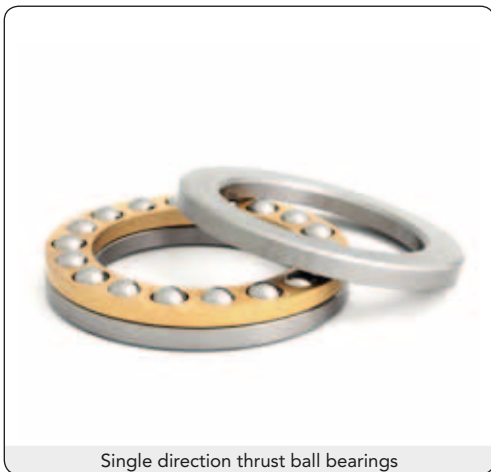

Single direction thrust ball bearings

Single direction thrust ball bearings

Single direction thrust ball bearings are composed of a shaft washers, housing washers and cage-balls assembly. Bearings are separable so washers and cage-balls assembly can be mounted separately. Axial deep groove ball bearings of series 511, 512, 513, 514 that have an flat housing washers, can support only axial forces in one direction and they cannot support any radial load and any misalignment.

Bearings of series 532 and 533 can support axial force in one direction, but having a spherical housing washer and matched with seating washer U2 and U3, they are able to compensate a misalignment between shaft and housing. No radial load can be supported.

Misalignment

Thrust ball bearings with flat washers do not have possibility to accommodate any misalignment between shaft and housing and any alignment errors between support surfaces in the housing and on the shaft. In presence of misalignment between the support surfaces in the housing and on the shaft, a thrust ball bearing with sphered housing washers matched with sphered seat washers should be used.

Minimum load

A minimum axial load is requested for a thrust ball bearing, like for all ball and roller bearings, to operate correctly, especially in critical application requirements like: high speed, high acceleration and sudden changes of rotating direction. In these operating conditions a skidding between the balls and raceways can be generated by the inertial forces, influencing negatively the bearing life. To calculate the minimum axial load please consult the RKB application engineering service.

However, the minimum axial load is reached or surpassed by the weight of the components

supported by the bearing, mostly when the shaft is vertical and the loads acting on it. If the minimum axial load is not reached or in case of application where a starting up at low temperature is planned or a lubricant with high viscosity is used, it will be necessary to preload the thrust ball bearings by springs or shaft nut. For additional information, please consult the RKB application engineering service.

Designs and variants

Type 51M



HB
BAINITE HT

S
STABILIZATION

- Flat housing locating washer
- Separable design
- One-piece machined brass cage (M) guided on balls
- Supports unidirectional axial loads

Variant 53M+U

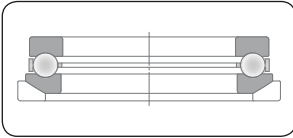

HB
BAINITE HT

S
STABILIZATION

- Sphered housing washer
- Separable design
- One-piece machined brass cage (M) guided on balls
- Supports unidirectional axial loads
- The sphered housing washer is mounted on a locating sphered seating washer to accommodate shaft misalignment

Prefixes

TBB	Out of standard thrust ball bearing followed by drawing number
U	Sphered housing washer associated to related thrust ball bearing

Suffixes**Internal design**

SP	Special or non-standard bearing
----	---------------------------------

Suffixes**Cage**

M	Machined brass cage guided on balls
F or MF	Machined steel cage guided on balls
J	Pressed steel cage guided on balls

Suffixes**Accuracy, clearance, running**

P6S	Dimensional and running accuracy between P6 and P5
-----	----------------------------------------------------

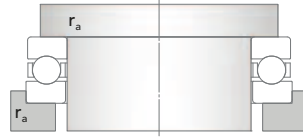
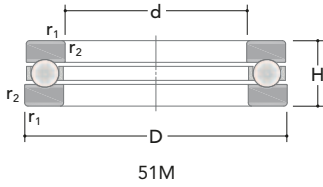

Main dimensions			Basic load ratings		Fatigue load limit C_u	Speed ratings		Designation
d	D	H	Dynamic C	Static C_0		Reference	Limiting	
[mm]			[kN]			[rpm]		Standard design
10	24	9	9,86	15	0,57	9200	11200	51100
	26	11	12,6	18,3	0,706	7700	9600	51200
12	26	9	10,4	16,3	0,63	8600	11200	51101
	28	11	13,3	20,5	0,776	7800	9500	51201
15	28	9	10,6	18,1	0,68	8100	10500	51102
	32	12	15,7	24,9	0,915	6800	8500	51202
17	30	9	11,5	21,2	0,77	8200	10400	51103
	35	12	16,4	26,6	1	6500	8100	51203
20	35	10	15	28,8	1,07	7300	8500	51104
	40	14	20,9	37,3	1,4	5700	6800	51204
25	42	11	18	38,9	1,44	6000	7700	51105
	47	15	26,2	49,1	1,9	5100	6600	51205
	52	18	34,8	59,9	2,23	4400	5500	51305
	60	24	42,2	66,3	2,49	3400	4400	51405
30	47	11	19	42,9	1,6	5800	7300	51106
	52	16	25	50,3	1,9	4600	5800	51206
	60	21	35,9	64,6	2,4	3600	4600	51306
	70	28	69,2	121	4,5	2800	3700	51406
35	52	12	20,1	50,5	1,87	5400	6400	51107
	62	18	35,6	72,9	2,6	3800	4800	51207
	68	24	49,9	94,9	3,61	3200	4200	51307
	80	32	75,2	136	5,1	2500	3100	51407
40	60	13	25,4	62,1	2,36	4800	6100	51108
	68	19	44,7	96	3,7	3700	4700	51208
	78	26	61,7	122	4,5	2900	3800	51308

Dimensions			Mass	Designation
d	r _{1,2min}	r _{amax}		Standard design
[mm]			[kg]	
10	0,3	0,3	0,02	51100
	0,6	0,6	0,03	51200
12	0,3	0,3	0,022	51101
	0,6	0,6	0,034	51201
15	0,3	0,3	0,023	51102
	0,6	0,6	0,046	51202
17	0,3	0,3	0,025	51103
	0,6	0,6	0,053	51203
20	0,3	0,3	0,037	51104
	0,6	0,6	0,083	51204
25	0,6	0,6	0,056	51105
	0,6	0,6	0,11	51205
	1	1	0,17	51305
	1	1	0,34	51405
30	0,6	0,6	0,063	51106
	0,6	0,6	0,13	51206
	1	1	0,26	51306
	1	1	0,52	51406
35	0,6	0,6	0,08	51107
	1	1	0,22	51207
	1	1	0,39	51307
	1,1	1	0,79	51407
40	0,6	0,6	0,12	51108
	1	1	0,28	51208
	1	1	0,53	51308

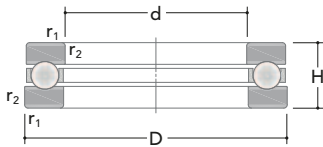

51M

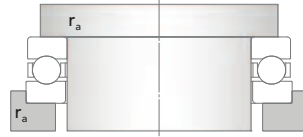

Main dimensions			Basic load ratings		Fatigue load limit C_u	Speed ratings		Designation Standard design
d	D	H	Dynamic C	Static C_0		Reference	Limiting	
[mm]			[kN]			[rpm]		
40	90	36	95	180	6,9	2300	2900	51408
(cont.)								
45	65	14	26,7	68,3	2,53	4300	5500	51109
50	70	14	27	73,7	2,8	4100	5500	51110
	78	22	48,9	116	4,3	3300	3900	51210
	95	31	81,5	167	6,4	2500	3100	51310
	110	43	159	335	12,7	1900	2400	51410
55	78	16	30	80,9	3	3600	4600	51111
	90	25	59,1	133	4,9	2700	3500	51211
	105	35	101	220	8,5	2100	2800	51311
	120	48	192	399	14,6	1700	2100	51411
60	85	17	42,1	121	4,59	3400	4300	51112
	95	26	59,4	140	5,1	2700	3400	51212
	110	35	101	222	8,4	2100	2600	51312
	130	51	202	430	16	1500	1900	51412
65	90	18	38	108	4	3300	4100	51113
	100	27	60	149	5,6	2500	3200	51213
	115	36	106	240	8,8	1900	2600	51313
	140	56	213	481	18	1400	1900	51413
70	95	18	40,4	120	4,4	3200	4000	51114
	105	27	63,2	160	5,85	2500	3100	51214
	125	40	135	320	11,8	1800	2300	51314
	150	60	231	540	19,7	1300	1800	51414
75	100	19	44,3	133	4,9	3000	3700	51115
	110	27	63,8	170	6,2	2300	3000	51215
	135	44	162	390	14	1600	2100	51315
	160	65	250	610	20,8	1200	1600	51415

Dimensions			Mass	Designation
d	r _{1,2min}	r _{amax}		Standard design
[mm]			[kg]	
40	1,1	1	1,1	51408
(cont.)				
45	0,6	0,6	0,14	51109
50	0,6	0,6	0,16	51110
	1	1	0,37	51210
	1,1	1	0,94	51310
	1,5	1,5	2	51410
55	0,6	0,6	0,23	51111
	1	1	0,59	51211
	1,1	1	1,3	51311
	1,5	1,5	2,55	51411
60	1	1	0,27	51112
	1	1	0,65	51212
	1,1	1	1,35	51312
	1,5	1,5	3,1	51412
65	1	1	0,33	51113
	1	1	0,72	51213
	1,1	1	1,5	51313
	2	2	4	51413
70	1	1	0,35	51114
	1	1	0,79	51214
	1,1	1	2	51314
	2	2	5	51414
75	1	1	0,4	51115
	1	1	0,83	51215
	1,5	1,5	2,6	51315
	2	2	6,75	51415

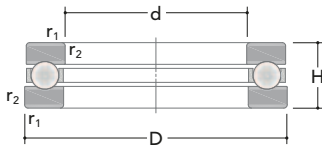

51M

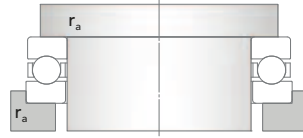

Main dimensions			Basic load ratings		Fatigue load limit C_u	Speed ratings		Designation
d	D	H	Dynamic C	Static C_0		Reference	Limiting	
[mm]			[kN]			[rpm]		
80	105	19	44,6	140	5,1	2900	3700	51116
	115	28	75,2	207	7,69	2300	2900	51216
	140	44	158	388	13,8	1600	2100	51316
	170	68	299	737	25	1100	1500	51416
85	110	19	45,2	146	5,4	2900	3700	51117
	125	31	96,4	275	9,8	2100	2600	51217
	150	49	173	405	14	1500	1900	51317
	180	72	287	736	24	1100	1400	51417
90	120	22	59,2	205	7,6	2500	3300	51118
	135	35	111	286	10,5	1900	2400	51218
	155	50	182	435	14,8	1400	1900	51318
	190	77	308	812	25,6	1000	1300	51418
100	135	25	81	265	9,15	2300	2800	51120
	150	38	118	320	11	1700	2100	51220
	170	55	227	560	18,6	1300	1700	51320
	170	55	232	600	19,9	1250	-	51320
	210	85	369	1040	32,1	920	1200	51420
110	145	25	82,4	280	9,7	2100	2800	51122
	160	38	124	360	11,8	1600	2100	51222
	190	63	281	805	24,8	1100	1500	51322
	197	86	452	1230	41,2			351977
	230	95	407	1210	34,8	870	1140	51422
120	155	25	84,6	305	9,65	2100	2600	51124
	155	25	83,7	300	9,5	2000	-	51124
	170	39	128	385	12	1500	1900	51224
	210	70	329	970	28,8	1000	1300	51324
	250	102	437	1310	36	780	950	51424

Dimensions			Mass	Designation
d	r _{1,2min}	r _{amax}		Standard design
[mm]			[kg]	
80	1	1	0,42	51116
	1	1	0,91	51216
	1,5	1,5	2,7	51316
	2,1	2	7,95	51416
85	1	1	0,44	51117
	1	1	1,2	51217
	1,5	1,5	3,55	51317
	2,1	2	9,45	51417
90	1	1	0,67	51118
	1,1	1	1,7	51218
	1,5	1,5	3,8	51318
	2,1	2	11	51418
100	1	1	0,97	51120
	1,1	1	2,2	51220
	1,5	1,5	4,95	51320
	15	1,5	5,4	51320
	3	2,5	15	51420
110	1	1	1,05	51122
	1,1	1	2,4	51222
	2	2	7,85	51322
	3	2,5	11,5	351977
	3	2,5	20	51422
120	1	1	1,15	51124
	1	1	1,25	51124
	1,1	1	2,65	51224
	2,1	2	11	51324
	4	3	25,5	51424

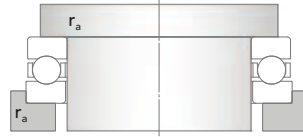
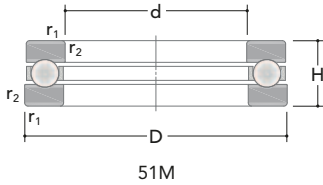

Main dimensions			Basic load ratings		Fatigue load limit C_u	Speed ratings		Designation Standard design
d	D	H	Dynamic C	Static C_0		Reference	Limiting	
[mm]			[kN]			[rpm]		
130	170	30	118	435	13,6	1800	2300	51126
	190	45	184	575	17	1300	1800	51226
	225	75	359	1150	32	960	1200	51326
	270	110	518	1710	46	720	900	51426
140	180	31	110	435	13	1700	2300	51128
	200	46	191	610	17,9	1300	1700	51228
	240	80	373	1240	32	910	1120	51328
	280	112	516	1740	44	670	900	51428
150	165	15,175	16	77,3	2,5	2580	-	634133
	190	31	110	435	12,6	1600	2100	51130
	215	50	239	785	22	1200	1600	51230
	250	80	390	1275	34	870	1140	51330
	300	120	551	1940	48	640	820	51430
160	200	31	111	465	12,9	1600	2100	51132
	225	51	236	830	22,4	1100	1500	51232
	270	87	450	1650	41,8	810	1050	51332
170	215	34	134	535	14,4	1500	1900	51134
	240	55	270	920	24	1100	1500	51234
	280	87	463	1740	43	760	940	51334
180	225	34	136	565	15	1400	1900	51136
	250	56	304	1110	28,8	1100	1400	51236
	300	95	527	1970	48,2	720	970	51336
190	240	37	173	700	18	1300	1700	51138
	270	62	334	1250	31	1000	1400	51238
	320	105	553	2220	51	670	810	51338
200	250	37	168	700	17,9	1300	1700	51140

Dimensions			Mass	Designation
d	r _{1,2min}	r _{amax}		Standard design
[mm]			[kg]	
130	1	1	1,85	51126
	1,5	1,5	4	51226
	2,1	2	13	51326
	4	3	32	51426
140	1	1	2,05	51128
	1,5	1,5	4,35	51228
	2,1	2	15,5	51328
	4	3	34,5	51428
150	0,6	0,5	0,4	634133
	1	1	2,2	51130
	1,5	1,5	6,1	51230
	2,1	2	16,5	51330
	4	3	42,5	51430
160	1	1	2,35	51132
	1,5	1,5	6,55	51232
	3	2,5	21	51332
170	1,1	1	3,3	51134
	1,5	1,5	8,15	51234
	3	2,5	22	51334
180	1,1	1	3,5	51136
	1,5	1,5	8,6	51236
	3	2,5	28,5	51336
190	1,1	1	4,05	51138
	2	2	12	51238
	4	3	36,5	51338
200	1,1	1	4,25	51140

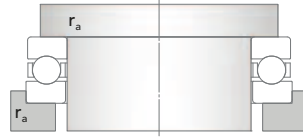
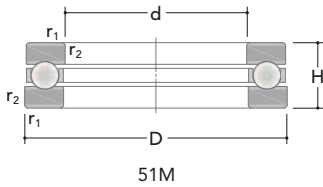

Main dimensions			Basic load ratings		Fatigue load limit C_u	Speed ratings		Designation Standard design
d	D	H	Dynamic C	Static C_0		Reference	Limiting	
[mm]			[kN]			[rpm]		
200 (cont.)	280	62	335	1310	31,7	1000	1300	51240
	340	110	619	2570	59,2	610	800	51340
220	270	37	176	800	19	1200	1700	51144
	300	63	359	1450	33,7	920	1120	51244
240	300	45	233	1020	24,1	1000	1400	51148
	340	78	450	1970	42,3	770	960	51248
260	320	45	235	1090	24	1000	1300	51152
	360	79	491	2210	47,1	720	970	51252
	480	175	1111	5400	108	360	-	51452
280	350	53	316	1440	30,9	920	1140	51156
	380	80	490	2300	47,9	720	900	51256
300	380	62	368	1740	35,9	810	1050	51160
	420	95	592	2990	57	610	740	51260
320	360	30	115	730	14,7	1200	-	51064
	400	48	243	1302,9	25,8	850	-	59164
	400	63	368	1840	36,9	770	940	51164
	440	95	572	2970	57	580	740	51264
340	420	64	376	1950	37,7	780	950	51168
	460	96	606	3160	59,2	550	690	51268
	540	160	1040	5770	10,5	360	490	51368
360	400	30	119	810	15,7	1120	-	51072
	440	48	257	1490	27,7	810	1050	59172
	440	65	394	2050	39	720	960	51172
	500	110	747	4110	74,2	480	610	51272

Dimensions			Mass	Designation
d	r _{1,2min}	r _{amax}		Standard design
[mm]			[kg]	
200	2	2	12	51240
(cont.)	4	3	44,5	51340
220	1,1	1	4,6	51144
	2	2	13	51244
240	1,5	1,5	7,55	51148
	2,1	2	23	51248
260	1,5	1,5	8,1	51152
	2,1	2	25	51252
	6	5	135	51452
280	1,5	1,5	12	51156
	2,1	2	26,5	51256
300	2	2	17,5	51160
	3	2,5	42	51260
320	1	1	4,3	51064
	2	2	13,5	59164
	2	2	19	51164
	3	2,5	45,5	51264
340	2	2	20,5	51168
	3	2,5	48,5	51268
	5	4	135	51368
360	1	1	4,85	51072
	2	2	15	59172
	2	2	22	51172
	4	3	70	51272

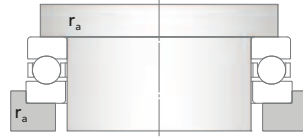
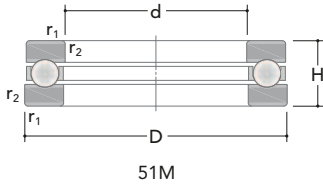

Main dimensions			Basic load ratings		Fatigue load limit C_u	Speed ratings		Designation
d	D	H	Dynamic C	Static C_0		Reference	Limiting	
[mm]			[kN]			[rpm]		
366	440	65	296	1450	27	690	-	634132
380	460	36	186	1130	21	890	1210	351793
	460	48	254	1510	28	780	1040	59176
	460	65	395	2190	40	730	870	51176
	520	112	721	4080	73	480	600	51276
	670	224	1635	10310	167	250	-	51476
385	510	110	612	3420	61	460	-	350550
400	480	48	257	1600	29	770	1050	59180
	480	65	402	2250	41	670	870	51180
	540	112	764	4490	76,7	450	610	51280
415,2	544,9	125	931	5660	97,2	-	-	351955
420	500	48	262	1670	31	780	1040	59184
	500	65	413	2390	41,7	680	870	51184
	580	130	886	5400	92	390	520	51284
440	520	65	303	1620	27,7	600	840	634131
	540	60	239	1490	25	630	860	59188
	540	80	523	3190	56	570	730	51188
	600	130	911	5590	95	390	520	51288
460	560	80	527	3230	54	570	690	51192
	620	130	922	5800	96	390	520	51292
480	580	80	545	3520	56	530	700	51196
	650	135	1003	6460	103	360	480	51296
500	540	30	133	1110	18,5	900	1210	510/500
	600	60	245	1680	26	620	840	591/500

Dimensions			Mass	Designation
d	r _{1,2min}	r _{amax}		Standard design
[mm]			[kg]	
366	1,1	1	19,5	634132
380	2	2	12,5	351793
	2	2	15	59176
	2	2	23	51176
	4	3	73	51276
	7,5	6	330	51476
385	4,3	3	66	350550
400	2	2	16,5	59180
	2	2	24	51180
	4	3	78,5	51280
415,2	4,5	4	81	351955
420	2	2	17	59184
	2	2	25,5	51184
	5	4	110	51284
440	1,1	1	24	634131
	2,1	2	28	59188
	2,1	2	42	51188
	5	4	115	51288
460	2,1	2	43,5	51192
	5	4	120	51292
480	2,1	2	45,5	51196
	5	4	130	51296
500	1	1	6,55	510/500
	2,1	2	32	591/500

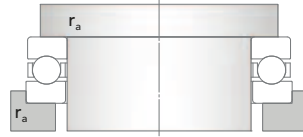
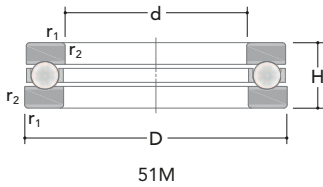

Main dimensions			Basic load ratings		Fatigue load limit C_u	Speed ratings		Designation Standard design
d	D	H	Dynamic C	Static C_0		Reference	Limiting	
[mm]			[kN]			[rpm]		
500 (cont.)	600	80	555	3580	57	540	700	511/500
	670	135	1002	6750	105	350	470	512/500
522	600	40	279	2230	34,7	-	-	351796
530	580	38	200	1580	25	770	1060	510/530
	590	36	178	1360	21,8	820	1050	351794
	640	67	468	3110	49	560	750	591/530
	640	85	659	4370	68	510	650	511/530
560	610	38	201	1680	25	780	1030	510/560
	670	67	463	3190	49	540	710	591/560
	670	85	651	4610	69	480	600	511/560
600	650	38	215	1790	26,6	740	950	510/600
	710	67	472	3380	49	510	700	591/600
	710	85	657	4720	70,7	480	600	511/600
	800	90	677	4930	70,5	410	540	350769
630	680	38	221	1900	28	730	970	510/630
	750	73	538	3990	57	500	640	591/630
	750	95	730	5310	77,8	430	550	511/630
670	730	45	282	2390	34	640	830	510/670
	800	78	534	4080	58	440	590	591/670
	800	105	842	6630	92,5	380	480	511/670
710	780	53	358	2800	40	550	730	510/710
	850	85	677	5390	72	410	550	591/710
	850	112	948	7640	100	350	460	511/710
730	850	85	669	5370	72	420	-	350627

Dimensions			Mass	Designation
d	r _{1,2min}	r _{amax}		Standard design
[mm]			[kg]	
500	2,1	2	47	511/500
(cont.)	5	4	135	512/500
522	1,5	1,5	17,5	351796
530	1,1	1	11	510/530
	1	1	12,5	351794
	3	2,5	43,5	591/530
	3	2,5	58,5	511/530
560	1,1	1	11,5	510/560
	3	2,5	45,5	591/560
	3	2,5	61	511/560
600	1,1	1	12	510/600
	3	2,5	48	591/600
	3	2,5	65	511/600
	5	4	117	350769
630	1,1	1	12,5	510/630
	3	2,5	62,5	591/630
	3	2,5	84	511/630
670	1,5	1,5	21	510/670
	4	3	74	591/670
	4	3	105	511/670
710	1,5	1,5	28	510/710
	4	3	88,5	591/710
	4	3	130	511/710
730	3	2,5	88	350627

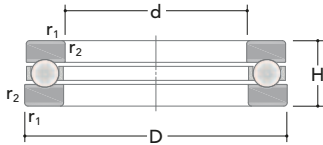

51M

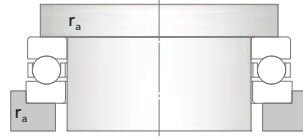

Main dimensions			Basic load ratings		Fatigue load limit C_u	Speed ratings		Designation Standard design
d	D	H	Dynamic C	Static C_0		Reference	Limiting	
[mm]			[kN]		[rpm]			
750	820	53	368	3000	41,2	540	750	510/750
	900	90	732	6300	79	360	530	591/750
	900	120	1020	8480	112	310	420	511/750
800	870	53	369	3160	41	510	690	510/800
	950	90	751	6450	84	360	480	591/800
	950	120	1020	8920	113	310	410	511/800
850	920	53	381	3390	44	-	-	510/850
	1000	90	768	6790	83	-	-	591/850
	1000	120	1070	9460	116	-	-	511/850
900	980	63	526	4810	59,6	-	-	510/900
	1060	95	622	7530	91	-	-	591/900
	1060	130	1110	10600	123	-	-	511/900
950	1080	63	537	5000	61	-	-	510/950
	1120	103	851	8130	96	-	-	591/950
	1120	135	1330	11840	139	-	-	511/950
980	1120	120	1020	9900	116	-	-	351883
1000	1090	70	571	5440	64	-	-	510/1000
	1180	109	931	9060	103	-	-	591/1000
	1180	140	1320	13100	151	-	-	511/1000
1060	1150	70	724	5750	65	-	-	510/1060
	1250	115	1000	10300	113	-	-	591/1060
	1250	150	1410	15000	163	-	-	511/1060
1120	1320	160	1540	16200	174	-	-	511/1120
1180	1400	175	1760	19700	207	-	-	511/1180

Dimensions			Mass	Designation
d	r _{1,2min}	r _{amax}		Standard design
[mm]			[kg]	
750	1,5	1,5	30	510/750
	4	3	105	591/750
	4	3	155	511/750
800	1,5	1,5	32,5	510/800
	4	3	110	591/800
	4	3	155	511/800
850	1,5	1,5	34,5	510/850
	4	3	115	591/850
	4	3	165	511/850
900	2	2	49	510/900
	5	4	140	591/900
	5	4	205	511/900
950	2	2	52	510/950
	5	4	170	591/950
	5	4	235	511/950
980	5	4	185	351883
1000	2,1	2	68,5	510/1000
	5	4	210	591/1000
	5	4	275	511/1000
1060	2,1	2	72,5	510/1060
	5	4	240	591/1060
	5	4	330	511/1060
1120	5	4	395	511/1120
1180	6	5	495	511/1180

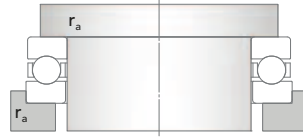
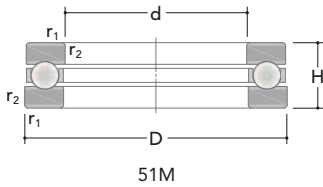

Main dimensions			Basic load ratings		Fatigue load limit C_u	Speed ratings		Designation Standard design
d	D	H	Dynamic C	Static C_0		Reference	Limiting	
[mm]			[kN]			[rpm]		
1250	1500	150	1420	16000	160	-	-	351006 A
1380	1540	130	1330	16200	157	-	-	351890
1400	1630	180	1830	23300	200	-	-	511/1400

Dimensions			Mass	Designation
d	r _{1,2min}	r _{amax}		Standard design
[mm]			[kg]	
1250	6	5	515	351006 A
1380	5	4	310	351890
1400	8	6	665	511/1400

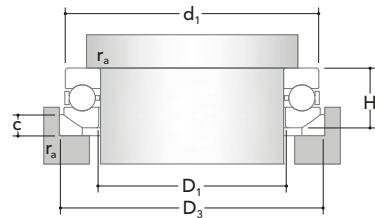
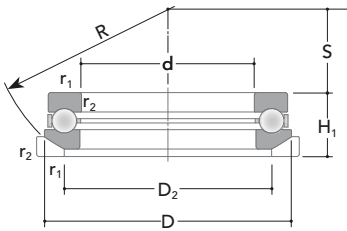

Main dimensions			Basic load ratings		Fatigue load limit C_u	Speed ratings		Designation Standard design
d	D	H ₁	Dynamic C	Static C ₀		Reference	Limiting	
[mm]			[kN]			[rpm]		
12	28	13	13,10	20,4	0,78	7700	9400	53201
15	32	15	15,7	24,8	0,926	6800	8500	53202
17	35	15	16,0	27	1	6500	8200	53203
20	40	17	20,9	37	1,4	5400	6900	53204
25	47	19	26,4	49,8	1,89	4800	6100	53205
30	52	20	24,9	50,7	1,87	4300	5400	53206
	60	25	35,9	65,3	2,4	3600	4600	53306
35	62	22	35,7	72,9	2,7	3800	4900	53207
	68	28	48,7	95,7	3,58	3000	3900	53307
40	68	23	44,0	96,5	3,6	3500	4600	53208
	78	31	62,0	121	4,5	2700	3500	53308
	90	42	95,5	181	6,9	2300	2800	53408
45	73	24	40	85,4	3,2	3200	4200	53209
	85	33	77	152	5,6	2500	3300	53309
50	78	26	50,1	114	4,4	3100	3900	53210
	95	37	81,0	169	6,3	2300	3000	53310
	110	50	157,0	335	12,7	1800	2300	53410
55	90	30	58,3	132	5	2700	3300	53211
	105	42	102,2	223	8,3	2100	2600	53311
	120	55	196,0	398	14,7	1600	2100	53411
60	95	31	59,0	138	5,2	2500	3100	53212
	110	42	99,6	222	8,4	1900	2700	53312

Dimensions											Mass	Designation	
d	r _{1,2min}	r _{amax}	d ₁	D ₁	D ₂	D ₃	H	C	R	s		Standard design	Seat washer
[mm]											[kg]		
12	0,6	0,6	28	14	20	30	11,4	3,5	25	11,5	0,045	53201	U 201
15	0,6	0,6	32	17	24	35	13,3	4	28	12	0,063	53202	U 202
17	0,6	0,6	35	19	26	38	13,2	4	32	16	0,071	53203	U 203
20	0,6	0,6	40	22	30	42	14,7	5	36	18	0,1	53204	U 204
25	0,6	0,6	47	27	36	50	16,7	5,5	40	19	0,15	53205	U 205
30	0,6	0,6	52	32	42	55	17,8	5,5	45	22	0,18	53206	U 206
	1	1	60	32	45	62	22,6	7	50	22	0,33	53306	U 306
35	1	1	62	37	48	65	19,9	7	50	24	0,28	53207	U 207
	1	1	68	37	52	72	25,6	7,5	56	24	0,46	53307	U 307
40	1	1	68	42	55	72	20,3	7	56	28,5	0,35	53208	U 208
	1	1	78	42	60	82	28,5	8,5	64	28	0,67	53308	U 308
	1,1	1	90	42	65	95	38,2	12	72	26	1,35	53408	U 408
45	1	1	73	47	60	78	21,3	7,5	56	26	0,39	53209	U 209
	1	1	85	47	65	90	30,1	10	64	25	0,83	53309	U 309
50	1	1	78	52	62	82	23,5	7,5	64	32,5	0,47	53210	U 210
	1,1	1	95	52	72	100	34,3	11	72	28	1,2	53310	U 310
	1,5	1,5	110	52	80	115	45,6	14	90	35	2,3	53410	U 410
55	1	1	90	57	72	95	27,3	9	72	35	0,75	53211	U 211
	1,1	1	105	57	80	110	39,3	11,5	80	30	1,7	53311	U 311
	1,5	1,5	120	57	88	125	50,5	15,5	90	28	3,1	53411	U 411
60	1	1	95	62	78	100	28	9	72	32,5	0,82	53212	U 212
	1,1	1	110	62	85	115	38,3	11,5	90	41	1,7	53312	U 312

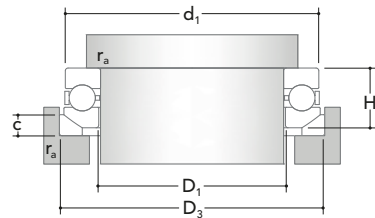
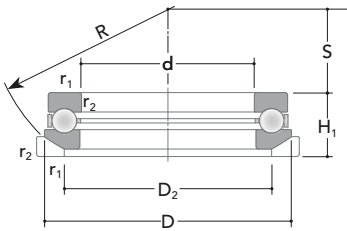

Main dimensions			Basic load ratings		Fatigue load limit C_u	Speed ratings		Designation Standard design
d	D	H ₁	Dynamic C	Static C ₀		Reference	Limiting	
[mm]			[kN]			[rpm]		
60	130	58	198	424	16	1500	1900	53412
(cont.)								
65	100	32	60,6	149	5,5	2500	3100	53213
	115	43	105,0	237	8,9	1900	2400	53313
70	105	32	62,1	157	5,96	2500	3200	53214
	125	48	135,0	315	12	1700	2300	53314
	150	69	236	545	19,5	1300	1700	53414
75	110	32	64	167	6,3	2300	2900	53215
	135	52	164,0	387	14	1600	2100	53315
	160	75	249	599	21,2	1200	1600	53415
80	115	33	75,1	206	7,72	2300	2800	53216
	140	52	160,0	387	13,8	1500	1900	53316
85	125	37	99	270	9	1900	2600	53217
	150	58	173	397	14	1400	1700	53317
90	135	42	110	287	10,5	1800	2300	53218
	155	59	184	438	14,7	1300	1700	53318
	190	88	301	806	25,8	1000	1300	53418
100	150	45	120,0	324	10,8	1600	2100	53220
	170	64	224,0	562	18,6	1200	1600	53320
	210	98	372,0	1050	31,8	920	1150	53420
110	160	45	126	360	11,8	1600	2100	53222
	190	72	278,0	801	24,9	1000	1400	53322
120	170	46	128,0	385	12	1400	1900	53224
	210	80	327	977	28,6	960	1200	53324

Dimensions												Mass	Designation	
d	r _{1,2min}	r _{amax}	d ₁	D ₁	D ₂	D ₃	H	C	R	s		Standard design	Seat washer	
[mm]											[kg]			
60	1,5	1,5	130	62	95	135	54	16	100	34	3,8	53412	U 412	
(cont.)														
65	1	1	100	67	82	105	28,7	9	80	40	0,91	53213	U 213	
	1,1	1	115	67	90	120	39,4	12,5	90	38,5	1,9	53313	U 313	
70	1	1	105	72	88	110	27	9	80	38	0,97	53214	U 214	
	1,1	1	125	72	98	130	44,2	13	100	43	2,5	53314	U 314	
	2	2	150	73	110	155	63,6	19,5	112	34	6,5	53414	U 414	
75	1	1	110	77	92	115	28,3	9,5	90	49	1	53215	U 215	
	1,5	1,5	135	77	105	140	48,1	15	100	37	3,2	53315	U 315	
	2	2	160	78	115	165	69	21	125	42	8,1	53415	U 415	
80	1	1	115	82	98	120	29,5	10	90	46	1,1	53216	U 216	
	1,5	1,5	140	82	110	145	47,6	15	112	50	3,2	53316	U 316	
85	1	1	125	88	105	130	33,1	11	100	52	1,5	53217	U 217	
	1,5	1,5	150	88	115	155	53,1	17,5	112	43	4,35	53317	U 317	
90	1,1	1	135	93	110	140	38,5	13,5	100	45	2,1	53218	U 218	
	1,5	1,5	155	93	120	160	54,6	18	112	40	4,7	53318	U 318	
	2,1	2	187	93	140	195	81,2	25,5	140	40	13	53418	U 418	
100	1,1	1	150	103	125	155	40,9	14	112	52	2,7	53220	U 220	
	1,5	1,5	170	103	135	175	59,2	18	125	46	5,95	53320	U 320	
	3	2,5	205	103	155	220	90	27	160	50	18	53420	U 420	
110	1,1	1	160	113	135	165	40,2	14	125	65	2,9	53222	U 222	
	2	2	187	113	150	195	67,2	20	140	51	9,1	53322	U 322	
120	1,1	1	170	123	145	175	40,8	15	125	61	3,2	53224	U 224	
	2,1	2	205	123	165	220	74,1	22	160	63	12,5	53324	U 324	

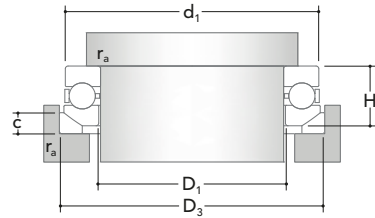
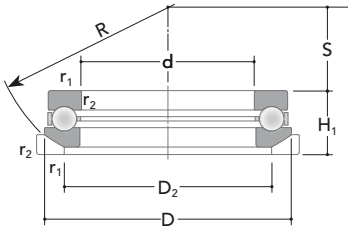

Main dimensions			Basic load ratings		Fatigue load limit C_u	Speed ratings		Designation Standard design
d	D	H ₁	Dynamic C	Static C ₀		Reference	Limiting	
[mm]			[kN]			[rpm]		
130	190	53	188,0	580	17	1200	1600	53226
140	200	55	189	614	17,8	1200	1600	53228

Dimensions											Mass	Designation	
d	r _{1,2min}	r _{amax}	d ₁	D ₁	D ₂	D ₃	H	C	R	s		Standard design	Seat washer
[mm]											[kg]		
130	1,5	1,5	187	133	160	195	47,9	17	140	67	4,85	53226	U 226
140	1,5	1,5	197	143	170	210	48,6	17	160	87	5,45	53228	U 228

Double direction thrust ball bearings

Double direction thrust ball bearings are composed of one shaft washers, two housing washers and two cage-balls assemblies. Bearings are separable so, washers and cage-balls assemblies can be mounted separately. Axial deep groove ball bearings of series 522, 523 that have flat housing washers, can support axial forces in both direction but they cannot withstand any radial load and any misalignment.

Bearings of series 542 and 543 can support axial force in both direction, but having a spherical housing washers and matched with seating washer U2 and U3, they are able to compensate a misalignment between shaft and housing. No radial load can be supported.

The main boundary dimensions of axial deep groove ball bearings with flat and sphered housing washers are in conformity with ISO 104:2015 and DIN 711:2010 and DIN 715:2011 (ISO 20516:2007), respectively. They are manufactured with tolerances according to ISO 199:2014.

Minimum load

A minimum axial load is requested for a thrust ball bearing, like for all ball and roller bearings, to operate correctly, especially in critical application requirements like: high speed, high acceleration and sudden changes of rotating direction. In these operating conditions a skidding between the balls and raceways can be generated by the inertial forces, influencing negatively the bearing life. To calculate the minimum axial load please consult the RKB application engineering service.



Designs and variants**Type 52M**

- Flat housing washers
- One-piece machined brass cage (M) guided on balls
- Separable design
- Supports medium to high bidirectional axial loads
- Suitable for applications requiring good limiting speeds

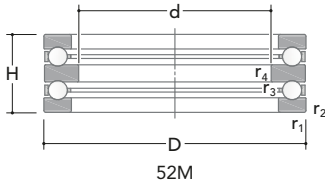

Main dimensions			Basic load ratings		Fatigue load limit C_u	Speed ratings		Designation Standard design
d	D	H	Dynamic C	Static C_0		Reference	Limiting	
[mm]			[kN]			[rpm]		
10	32	22	15,70	24,7	0,926	5100	6700	52202
15	40	26	21,2	36,8	1,4	4100	5200	52204
20	47	28	26,1	49,5	1,88	3600	4600	52205
	52	34	35,0	59,5	2,26	3100	3900	52305
	70	52	69,9	121	4,5	2100	2800	52406
25	52	29	25,0	51,4	1,85	3500	4300	52206
	60	38	35,9	64,5	2,4	2700	3400	52306
	80	59	75,8	136	5,1	1900	2400	52407
30	62	34	35	72,9	2,7	2900	3700	52207
	68	36	44,0	95,1	3,7	2700	3300	52208
	68	44	50,0	95,5	3,59	2300	2900	52307
	78	49	63	121	4,5	2100	2600	52308
	90	65	96,0	180	6,9	1700	2100	52408
35	73	37	39,0	86,2	3,2	2500	3100	52209
	85	52	76,7	153	5,6	1900	2400	52309
	100	72	124	240	9	1500	1900	52409
40	78	39	49,9	115	4,3	2300	3000	52210
	95	58	81,9	169	6,3	1700	2300	52310
45	90	45	59,0	132	5	2100	2600	52211
	105	64	102,4	221	8,4	1500	1900	52311
	120	87	194,0	395	14,8	1200	1600	52411
50	95	46	60,0	138	5,2	1900	2400	52212
	110	64	100,8	222	8,4	1500	1900	52312
	130	93	199,0	428	16	1100	1500	52412

Dimensions					Mass	Designation
d	r _{1,2min}	r _{3,4min}	r _{amax}	r _{bmax}		Standard design
[mm]					[kg]	
10	0,6	0,3	0,6	0,3	0,081	52202
15	0,6	0,3	0,6	0,3	0,15	52204
20	0,6	0,3	0,6	0,3	0,22	52205
	1	0,3	1	0,3	0,33	52305
	1	0,6	1	0,6	1	52406
25	0,6	0,3	0,6	0,3	0,25	52206
	1	0,3	1	0,3	0,47	52306
	1,1	0,6	1	0,6	1,45	52407
30	1	0,3	1	0,3	0,41	52207
	1	0,6	1	0,6	0,55	52208
	1	0,3	1	0,3	0,68	52307
	1	0,6	1	0,6	1,05	52308
	1,1	0,6	1	0,6	2,05	52408
35	1	0,6	1	0,6	0,6	52209
	1	0,6	1	0,6	1,25	52309
	1,1	0,6	1	0,6	2,7	52409
40	1	0,6	1	0,6	0,71	52210
	1,1	0,6	1	0,6	1,75	52310
45	1	0,6	1	0,6	1,1	52211
	1,1	0,6	1	0,6	2,4	52311
	1,5	0,6	1,5	0,6	4,7	52411
50	1	0,6	1	0,6	1,2	52212
	1,1	0,6	1	0,6	2,55	52312
	1,5	0,6	1,5	0,6	6,35	52412

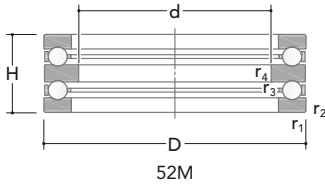

Main dimensions			Basic load ratings		Fatigue load limit C_u	Speed ratings		Designation Standard design
d	D	H	Dynamic C	Static C_0		Reference	Limiting	
[mm]			[kN]		[rpm]			
55	100	47	61	148	5,6	1900	2500	52213
	105	47	62,3	159	5,89	1800	2300	52214
	115	64	105,0	237	8,9	1500	1900	52313
	125	72	136,0	319	11,8	1300	1700	52314
	250	107	233	539	19,7	760	1000	52414
60	110	47	64,2	168	6,3	1800	2300	52215
	135	79	163	384	14	1200	1600	52315
65	115	48	77	207	7,69	2300	3000	52216
	140	79	159,0	387	13,8	1200	1600	52316
70	125	55	96	271	9,9	1500	1900	52217
75	135	62	114,0	285	11,8	1400	1700	52218
85	150	67	120	324	10,8	1200	1600	52220
	170	97	225	567	18,4	970	1200	52320
95	160	67	125	358	11,8	1200	1600	52222
100	170	68	128	386	11,9	1100	1500	52224
110	190	80	180,0	584	16,6	1000	1300	52226
120	200	81	191,0	611	17,9	970	1200	52228
130	215	89	236	789	22	910	1100	52230
140	225	90	235,0	829	22,4	870	1100	52232
150	240	97	266	917	24	820	1100	52234
	250	98	303	1110	28,8	770	1000	52236

Dimensions					Mass	Designation
d	r _{1,2min}	r _{3,4min}	r _{amax}	r _{bmax}		Standard design
[mm]					[kg]	
55	1	0,6	1	0,6	1,35	52213
	1	1	1	1	1,5	52214
	1,1	0,6	1	0,6	2,75	52313
	1,1	1	1	1	3,65	52314
	2	1	1,5	1	9,7	52414
60	1	1	1	1	1,55	52215
	1,5	1	1,5	1	4,8	52315
65	1	1	1	1	1,7	52216
	1,5	1	1	1	4,95	52316
70	1	1	1	1	2,4	52217
75	1,1	1	1	1	3,2	52218
85	1,1	1	1	1	4,2	52220
	1,5	1	1	1	8,95	52320
95	1,1	1	1	1	4,65	52222
100	1,1	1,1	1	1	5,25	52224
110	1,5	1,1	1,5	1	8	52226
120	1,5	1,1	1,5	1	8,65	52228
130	1,5	1,1	1,5	1	11,5	52230
140	1,5	1,1	1,5	1	12	52232
150	1,5	1,1	1,5	1	15	52234
	1,5	2	1,5	2	16	52236

Cylindrical roller thrust bearings

The cylindrical roller thrust bearings manufactured by RKB are designed to support high axial loads (no radial loads are allowed on this kind of bearing). The manufacturing program includes single and double direction cylindrical roller thrust bearings with flat or spherical housing washers to meet any requirements in various industrial applications. Thanks to the improved internal geometry and the use of the most suitable raw materials, all RKB cylindrical roller thrust bearings attain the highest axial load ratings and the best reliability. Depending on application requirements, RKB Bainite Hardening Treatment (HB) and High Temperature Dimensional Stabilization (S) can be applied on bearing rings and rolling elements. The bearing dimensional and running accuracy conforms to ISO/ABMA/GOST specifications.



Single direction cylindrical roller thrust bearing

Single direction cylindrical roller thrust bearings

Single direction cylindrical roller thrust bearings are composed of a housing washers GS, shaft washers WS and cage-cylindrical rollers assembly. Bearings are separable so, washers and cage-cylindrical rollers assembly can be mounted separately. These bearings are characterized by a very low axial section, high load capacity and high stiffness. They can support only axial loads in one direction and are not available to support radial force and tilting moments. Axial cylindrical roller bearings of series 811 and 812 are single row bearings while the bearings of series 893 and 894 are double row bearings and their presence is required for heavy loads. Shaft washers WS are centered on the shaft while housing washers are centered in the housing. Both washers have a bore diameter, outer diameter and rolling surface precision machined.

Misalignment

Cylindrical roller thrust bearings do not allow any misalignment between shaft and housing and any alignment errors between support surfaces in the housing and on the shaft.

Minimum load

A minimum axial load is requested for a cylindrical roller thrust bearing bearing, like for all ball and roller bearings, to operate correctly, especially in critical application requirements like: high speed, high acceleration and sudden changes of rotating direction. In these operating conditions a skidding between the cylindrical rollers and raceways can be generated by the inertial forces, influencing negatively the bearing life. To calculate the minimum axial load please consult the RKB application engineering service.

However, the minimum axial load is reached or surpassed by the weight of the components supported by the bearing, mostly when the shaft is vertical and the loads acting on it. If the minimum axial load is not reached or in case of application where a starting up at low temperature is planned or a lubricant with high viscosity is used, it will be necessary to preload the thrust cylindrical bearings by springs or shaft nut.

For additional information, please consult the RKB application engineering service.

Designs and variants

Type 81M

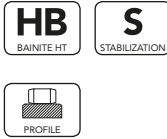
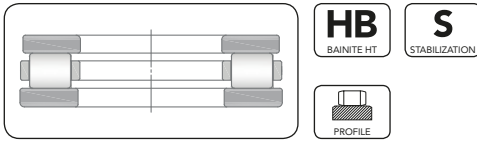

- Flat housing locating washer
- Low cross section separable design
- Two-piece machined brass cage (M) guided on rollers
- Supports unidirectional axial loads

Type TCRBU

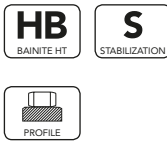
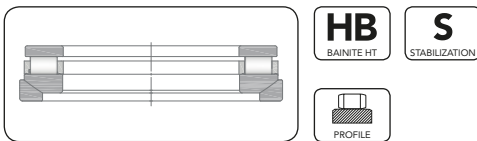

- Sphered housing washer
- Low cross section separable design
- Two-piece machined brass cage (M) guided on rollers
- Supports unidirectional axial loads
- The sphered housing washer is mounted on a locating sphered seating washer to accommodate shaft misalignment

Type 89M

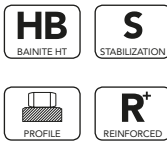
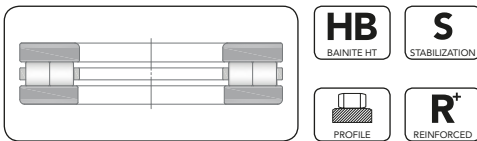

- Flat housing locating washer
- Two rows of rollers
- Two-piece machined brass cage (M) guided on rollers
- Low cross section separable design
- Supports unidirectional axial loads

Prefixes

T	Single direction cylindrical roller thrust bearing followed by size indication
AT	Self-aligning single direction cylindrical roller thrust bearing followed by size indication
GS	Housing washer
WS	Shaft washer
K	Cylindrical roller and cage thrust assembly
LS	Universal washer

Suffixes

Internal design

SP	Special or non-standard bearing
----	---------------------------------

Suffixes

Cage

M	Machined brass cage guided on rollers
TN or ATN	Molded polyamide cage (PA66) guided on rollers
TN9	Molded glass fiber-reinforced polyamide cage (PA66-GF25) guided on rollers

Suffixes

Accuracy, clearance, running

P6S	Dimensional and running accuracy between P6 and P5
-----	----------------------------------------------------

Prefixes

Alternative designation

TCRB	Out of standard single direction cylindrical roller thrust bearing followed by drawing number
TTCRB	Out of standard double direction cylindrical roller thrust bearing followed by drawing number
TCRBU	Out of standard single direction cylindrical roller thrust bearing with sphered housing washer followed by drawing number

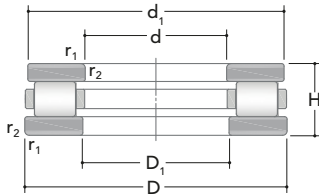

81M

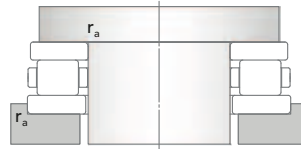

Main dimensions					Basic load ratings		Fatigue load limit C_u	Speed ratings		Designation Standard design
d	D	H	d1	D1	Dynamic C	Static C_0		Reference	Limiting	
[mm]					[kN]			[rpm]		
15	28	9	28	16	11,10	26,7	2,48	4000	7500	81102
17	30	9	30	18	12,1	31	2,9	3900	7400	81103
20	35	10	35	21	19,0	47,3	4,72	3500	6400	81104
25	42	11	42	26	25,0	68,2	6,9	3000	5400	81105
30	47	11	47	32	27,1	77,7	7,68	2700	5100	81106
	52	16	52	32	49,3	132	13,6	2200	4100	81206
	60	18	60	32	52,6	182	18,4	2300	4600	89306
35	52	12	52	37	29	93	9,15	2500	4800	81107
	62	18	62	37	62,0	188	19,5	1800	3400	81207
	68	20	68	37	61,7	219	22	2200	4100	89307
40	60	13	60	42	43,3	136	13,8	2200	4400	81108
	68	19	68	42	82,9	252	26,8	1700	3300	81208
	78	22	78	42	96,0	361	36,9	1800	3500	89308
45	65	14	65	47	45	150	15,6	2000	3900	81109
	73	20	73	47	84	254	26,6	1600	3200	81209
	85	24	85	47	108,0	422	43	1600	3100	89309
50	70	14	70	52	47,1	163	16,9	2100	3700	81110
	78	22	78	52	91,2	299	31	1600	3000	81210
	95	27	95	52	131,0	526	54	1500	2800	89310
55	78	16	78	57	68,6	284	29	1800	3300	81111
	90	25	90	57	122,0	386	40	1300	2400	81211
	105	30	105	57	145,0	566	58,9	1400	2600	89311
60	85	17	85	62	80,2	294	31,1	1700	3200	81112



TCRBU



89M

Dimensions			Mass	Designation		Designation of components			
d	r _{1,2min}	r _{amax}		Standard design	Roller thrust cage assembly	Washer type		Universal	
[mm]			[kg]			Shaft	Housing		
15	0,3	0,3	0,024	81102	K 81102	WS 81102	GS 81102	LS 1528	
17	0,3	0,3	0,027	81103	K 81103	WS 81103	GS 81103	LS 1730	
20	0,3	0,3	0,037	81104	K 81104	WS 81104	GS 81104	LS 2035	
25	0,6	0,6	0,053	81105	K 81105	WS 81105	GS 81105	LS 2542	
30	0,6	0,6	0,057	81106	K 81106	WS 81106	GS 81106	LS 3047	
	0,6	0,6	0,12	81206	K 81206	WS 81206	GS 81206	-	
	1	1	0,24	89306	K 89306	WS 89306	GS 89306	-	
35	0,6	0,6	0,073	81107	K 81107	WS 81107	GS 81107	LS 3552	
	1	1	0,21	81207	K 81207	WS 81207	GS 81207	-	
	1	1	0,34	89307	K 89307	WS 89307	GS 89307	-	
40	0,6	0,6	0,11	81108	K 81108	WS 81108	GS 81108	LS 4060	
	1	1	0,25	81208	K 81208	WS 81208	GS 81208	-	
	1	1	0,48	89308	K 89308	WS 89308	GS 89308	-	
45	0,6	0,6	0,13	81109	K 81109	WS 81109	GS 81109	LS 4565	
	1	1	0,29	81209	K 81209	WS 81209	GS 81209	-	
	1	1	0,62	89309	K 89309	WS 89309	GS 89309	-	
50	0,6	0,6	0,14	81110	K 81110	WS 81110	GS 81110	LS 5070	
	1	1	0,36	81210	K 81210	WS 81210	GS 81210	-	
	1,1	1,1	0,89	89310	K 89310	WS 89310	GS 89310	-	
55	0,6	0,6	0,23	81111	K 81111	WS 81111	GS 81111	LS 5578	
	1	1	0,57	81211	K 81211	WS 81211	GS 81211	-	
	1,1	1,1	1,2	89311	K 89311	WS 89311	GS 89311	-	
60	1	1	0,27	81112	K 81112	WS 81112	GS 81112	LS 6085	

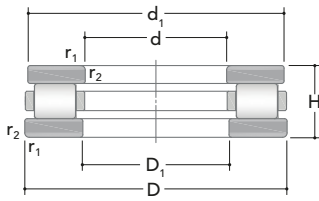

81M

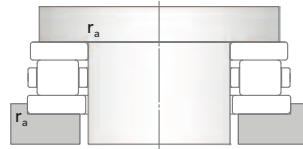

Main dimensions					Basic load ratings		Fatigue	Speed ratings		Designation
d	D	H	d1	D1	Dynamic C	Static C ₀	load limit C _u	Reference	Limiting	Standard design
[mm]					[kN]			[rpm]		
60 (cont.)	95	26	95	62	136	463	47,7	1300	2500	81212
	110	30	110	62	150,0	633	66,2	1300	2400	89312
	130	42	130	62	311,0	1160	127	1100	2100	89412
65	90	18	90	67	83	317	32,8	1600	3000	81113
	100	27	100	67	142,0	483	51	1200	2300	81213
	115	30	115	67	150,0	639	65,6	1300	2400	89313
	140	45	140	68	356	1378	142	1000	1900	89413
70	95	18	95	72	86	340	35	1600	2900	81114
	105	27	105	72	148,0	525	56	1200	2300	81214
	125	34	125	72	186	798	81,7	1200	2200	89314
	150	48	150	73	375	1440	152	970	1700	89414
75	100	19	100	77	82,5	338	34	1500	2800	81115
	110	27	110	77	137,0	484	51	1100	2100	81215
	135	36	135	77	228	946	100	1100	2100	89315
	160	51	160	78	394	1520	157	920	1600	89415
80	105	19	105	82	81	331	34	1400	2600	81116
	115	28	115	82	157	603	64	1100	2100	81216
	140	36	140	82	238	1050	109	1100	2100	89316
	170	54	170	83	436	1720	174	870	1500	89416
85	110	19	110	87	87,0	360	38	1400	2600	81117
	125	31	125	88	169,0	639	67	1000	1900	81217
	150	39	150	88	254	1080	112	1000	1900	89317
	180	58	180	88	491	1910	192	810	1500	89417
90	120	22	120	92	111,0	445	46	1260	2300	81118
	135	35	135	93	234,0	855	91	960	1800	81218
	155	39	155	93	262	1140	116	970	1700	89318
	190	60	190	93	536	2090	211	780	1400	89418



TCRBU

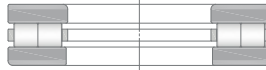

89M

Dimensions			Mass	Designation	Designation of components			
d	r _{1,2min}	r _{amax}			Standard design	Roller thrust cage assembly	Washer type	
[mm]			[kg]			Shaft	Housing	
60 (cont.)	1	1	0,65	81212	K 81212	WS 81212	GS 81212	-
	1,1	1,1	1,25	89312	K 89312	WS 89312	GS 89312	-
	1,5	1,5	2,8	89412	K 89412	WS 89412	GS 89412	-
65	1	1	0,31	81113	K 81113	WS 81113	GS 81113	LS 6590
	1	1	0,72	81213	K 81213	WS 81213	GS 81213	-
	1,1	1,1	1,35	89313	K 89313	WS 89313	GS 89313	-
	2	2	3,5	89413	K 89413	WS 89413	GS 89413	-
70	1	1	0,33	81114	K 81114	WS 81114	GS 81114	LS 7095
	1	1	0,77	81214	K 81214	WS 81214	GS 81214	-
	1,1	1,1	1,8	89314	K 89314	WS 89314	GS 89314	-
	2	2	4,2	89414	K 89414	WS 89414	GS 89414	-
75	1	1	0,39	81115	K 81115	WS 81115	GS 81115	LS 75100
	1	1	0,8	81215	K 81215	WS 81215	GS 81215	-
	1,5	1,5	2,25	89315	K 89315	WS 89315	GS 89315	-
	2	2	5,95	89415	K 89415	WS 89415	GS 89415	-
80	1	1	0,4	81116	K 81116	WS 81116	GS 81116	LS 80105
	1	1	0,9	81216	K 81216	WS 81216	GS 81216	-
	1,5	1,5	2,35	89316	K 89316	WS 89316	GS 89316	-
	2,1	2,1	7,05	89416	K 89416	WS 89416	GS 89416	-
85	1	1	0,42	81117	K 81117	WS 81117	GS 81117	LS 85110
	1	1	1,2	81217	K 81217	WS 81217	GS 81217	-
	1,5	1,5	3,4	89317	K 89317	WS 89317	GS 89317	-
	2,1	2,1	8,65	89417	K 89417	WS 89417	GS 89417	-
90	1	1	0,62	81118	K 81118	WS 81118	GS 81118	LS 90120
	1,1	1,1	1,75	81218	K 81218	WS 81218	GS 81218	-
	1,5	1,5	3,65	89318	K 89318	WS 89318	GS 89318	-
	2,1	2,1	9,95	89418	K 89418	WS 89418	GS 89418	-

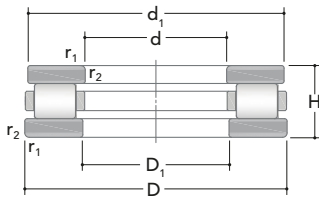

81M

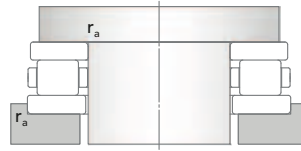

Main dimensions					Basic load ratings		Fatigue load limit C_u	Speed ratings		Designation Standard design
d	D	H	d1	D1	Dynamic C	Static C_0		Reference	Limiting	
[mm]					[kN]		[rpm]			
100	135	25	135	102	154,0	619	63	1150	2100	81120
	150	38	150	103	267	1040	106	860	1600	81220
	170	42	170	103	296	1350	134	920	1600	89320
	210	67	210	103	679,0	2780	267	670	1200	89420
110	145	25	145	112	164,0	676	65,9	1060	1900	81122
	160	38	160	113	258	988	99	820	1500	81222
	190	48	190	113	399	1810	175	820	1500	89322
	230	73	230	113	791,0	3320	313	600	1100	89422
120	155	25	155	122	168	731	68	1070	1900	81124
	170	39	170	123	257	986	97,9	770	1400	81224
	210	54	210	123	500	2350	217	730	1300	89324
	250	78	250	123	928,0	3870	358	570	1050	89424
130	170	30	170	132	196	869	82,5	920	1700	81126
	190	45	187	133	382	1445	138	670	1200	81226
	225	58	225	134	556	2610	244	670	1200	89326
	270	85	270	134	1076	4480	402	510	950	89426
140	180	31	178	142	207,0	914	86	870	1600	81128
	200	46	197	143	355	1388	130	670	1200	81228
	240	60	240	144	641	3070	278	650	1150	89328
	280	85	280	144	1097	4740	430	510	1000	89428
150	190	31	188	152	211,0	990	89	820	1500	81130
	215	50	212	153	469,0	1870	173	610	1100	81230
	250	60	250	154	665,0	3200	289	600	1100	89330
	300	90	300	154	1245	5570	483	480	900	89430
160	200	31	198	162	214	1000	92	820	1500	81132
	225	51	220	163	482	1980	178	580	1050	81232
	320	95	320	164	1448	6478	533	460	850	89432



TCRBU

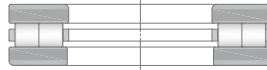

89M

Dimensions			Mass	Designation	Designation of components			
d	r _{1,2min}	r _{amax}			Standard design	Roller thrust cage assembly	Washer type	
[mm]			[kg]			Shaft	Housing	
100	1	1	0,95	81120	K 81120	WS 81120	GS 81120	LS 100135
	1,1	1,1	2,2	81220	K 81220	WS 81220	GS 81220	-
	1,5	1,5	4,55	89320	K 89320	WS 89320	GS 89320	-
	3	3	13,5	89420	K 89420	WS 89420	GS 89420	-
110	1	1	1,05	81122	K 81122	WS 81122	GS 81122	LS 110145
	1,1	1,1	2,3	81222	K 81222	WS 81222	GS 81222	-
	2	2	6,7	89322	K 89322	WS 89322	GS 89322	-
	3	3	17,5	89422	K 89422	WS 89422	GS 89422	-
120	1	1	1,1	81124	K 81124	WS 81124	GS 81124	LS 120155
	1,1	1,1	2,55	81224	K 81224	WS 81224	GS 81224	-
	2,1	2,1	9,45	89324	K 89324	WS 89324	GS 89324	-
	4	4	22	89424	K 89424	WS 89424	GS 89424	-
130	1	1	1,65	81126	K 81126	WS 81126	GS 81126	LS 130170
	1,5	1,5	4	81226	K 81226	WS 81226	GS 81226	-
	2,1	2,1	11	89326	K 89326	WS 89326	GS 89326	-
	4	4	27	89426	K 89426	WS 89426	GS 89426	-
140	1	1	1,9	81128	K 81128	WS 81128	GS 81128	LS 140180
	1,5	1,5	5,05	81228	K 81228	WS 81228	GS 81228	-
	2,1	2,1	12,5	89328	K 89328	WS 89328	GS 89328	-
	4	4	29,5	89428	K 89428	WS 89428	GS 89428	-
150	1	1	2,2	81130	K 81130	WS 81130	GS 81130	LS 150190
	1,5	1,5	7,2	81230	K 81230	WS 81230	GS 81230	-
	2,1	2,1	14	89330	K 89330	WS 89330	GS 89330	-
	4	4	35,5	89430	K 89430	WS 89430	GS 89430	-
160	1	1	2,1	81132	K 81132	WS 81132	GS 81132	LS 160200
	1,5	1,5	7,6	81232	K 81232	WS 81232	GS 81232	-
	5	5	42	89432	K 89432	WS 89432	GS 89432	-

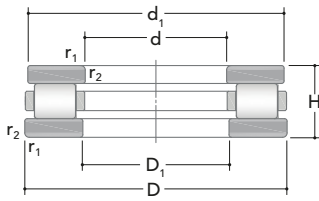

81M

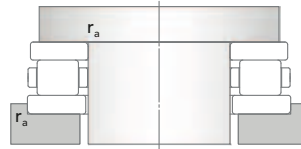

Main dimensions					Basic load ratings		Fatigue load limit C_u	Speed ratings		Designation Standard design
d	D	H	d1	D1	Dynamic C	Static C_0		Reference	Limiting	
[mm]					[kN]			[rpm]		
170	215	34	215	172	287	1320	120	770	1400	81134
	240	55	237	173	544	2270	201	540	950	81234
	340	103	340	174	1613	7120	607	410	750	89434
180	225	34	222	183	272	1250	112	720	1300	81136
	250	56	247	183	548	2390	205	540	950	81236
	360	109	360	184	1738	7880	665	390	700	89436
190	240	37	237	193	311	1453	126	670	1200	81138
	270	62	267	194	696	2850	254	480	900	81238
	380	115	380	195	1969	8880	730	360	650	89438
200	250	37	250	203	312	1480	127	670	1200	81140
	280	62	277	204	722	3080	257	480	900	81240
	400	122	400	205	2171	9830	814	350	600	89440
220	270	37	267	223	331	1680	139	650	-	81144
	300	63	297	224	753	3330	277	460	850	81244
	420	122	420	225	2304	10980	898	320	600	89444
240	300	45	297	243	478	2430	198	540	950	81148
	340	78	335	244	1086	4880	392	380	700	81248
260	320	45	317	263	483	2550	204	510	950	81152
	360	79	355	264	1157	5250	419	360	650	81252
280	350	53	347	283	681	3490	280	460	850	81156
	380	80	375	284	1159	5390	434	340	650	81256
300	380	62	376	304	843	4350	339	410	750	81160
	420	95	415	304	1536	7100	548	300	550	81260



TCRBU

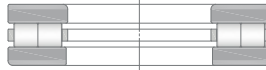

89M

Dimensions			Mass	Designation	Designation of components			
d	r _{1,2min}	r _{amax}			Standard design	Roller thrust cage assembly	Washer type	
[mm]			[kg]			Shaft	Housing	
170	1,1	1,1	2,4	81134	K 81134	WS 81134	GS 81134	-
	1,5	1,5	9,3	81234	K 81234	WS 81234	GS 81234	-
	5	5	52	89434	K 89434	WS 89434	GS 89434	-
180	1,1	1,1	3,7	81136	K 81136	WS 81136	GS 81136	-
	1,5	1,5	9,95	81236	K 81236	WS 81236	GS 81236	-
	5	5	60	89436	K 89436	WS 89436	GS 89436	-
190	1,1	1,1	4,75	81138	K 81138	WS 81138	GS 81138	-
	2	2	12	81238	K 81238	WS 81238	GS 81238	-
	5	5	65,5	89438	K 89438	WS 89438	GS 89438	-
200	1,1	1,1	4,95	81140	K 81140	WS 81140	GS 81140	-
	2	2	13,5	81240	K 81240	WS 81240	GS 81240	-
	5	5	75	89440	K 89440	WS 89440	GS 89440	-
220	1,1	1,1	5,2	81144	K 81144	WS 81144	GS 81144	-
	2	2	15	81244	K 81244	WS 81244	GS 81244	-
	6	6	84,5	89444	K 89444	WS 89444	GS 89444	-
240	1,5	1,5	8,45	81148	K 81148	WS 81148	GS 81148	-
	2,1	2,1	22	81248	K 81248	WS 81248	GS 81248	-
260	1,5	1,5	9,1	81152	K 81152	WS 81152	GS 81152	-
	2,1	2,1	27	81252	K 81252	WS 81252	GS 81252	-
280	1,5	1,5	12,5	81156	K 81156	WS 81156	GS 81156	-
	2,1	2,1	30	81256	K 81256	WS 81256	GS 81256	-
300	2	2	19,5	81160	K 81160	WS 81160	GS 81160	-
	3	3	43	81260	K 81260	WS 81260	GS 81260	-

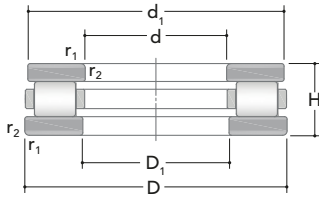

81M

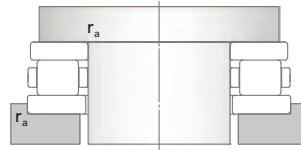

Main dimensions					Basic load ratings		Fatigue load limit C_u	Speed ratings		Designation Standard design
d	D	H	d1	D1	Dynamic C	Static C_0		Reference	Limiting	
[mm]					[kN]			[rpm]		
320	400	63	396	324	880	4560	352	380	700	81164
	440	95	435	325	1500	7450	518	280	550	81264
340	420	64	416	344	896	4840	359	360	700	81168
	460	96	455	345	1613	7850	566	280	510	81268
360	440	65	436	364	891	4860	358	360	660	81172
	500	110	495	365	2110	10280	680	250	460	81272
380	460	65	456	384	909	5280	345	350	650	81176
400	480	65	476	404	966	5530	395	340	600	81180
420	500	65	495	424	973	5820	402	320	600	81184
440	540	80	535	444	1441	7870	559	280	550	81188
460	560	80	555	464	1463	8460	573	280	520	81192
480	580	80	575	484	1475	8530	558	270	500	81196
500	600	80	595	505	1545	9166	629	260	490	811/500
530	640	85	635	535	1713	10450	690	250	470	811/530
560	670	85	665	565	1738	10910	716	250	430	811/560
600	710	85	705	605	1782	11590	721	230	430	811/600
630	750	73	746	634	1631	11190	696	220	420	891/630
	750	95	746	634	2133	13630	869	210	390	811/630
	850	175	842	638	4778	25650	1581	130	250	812/630



TCRBU



89M

Dimensions			Mass	Designation	Designation of components			
d	r _{1,2min}	r _{amax}			Standard design	Roller thrust cage assembly	Washer type Shaft	Housing
[mm]			[kg]					
320	2	2	20,5	81164	K 81164	WS 81164	GS 81164	-
	3	2,5	42,5	81264	-	-	-	-
340	2	2	22,5	81168	K 81168	WS 81168	GS 81168	-
	3	2,5	47	81268	-	-	-	-
360	2	2	19,5	81172	-	-	-	-
	4	3	65,5	81272	-	-	-	-
380	2	2	22	81176	-	-	-	-
400	2	2	23	81180	-	-	-	-
420	2	2	24	81184	-	-	-	-
440	2,1	2	39,5	81188	-	-	-	-
460	2,1	2	41	81192	-	-	-	-
480	2,1	2	43	81196	-	-	-	-
500	2,1	2	44	811/500	-	-	-	-
530	3	2,5	55,5	811/530	-	-	-	-
560	3	2,5	58	811/560	-	-	-	-
600	3	2,5	62	811/600	-	-	-	-
630	3	2,5	62	891/630	-	-	-	-
	3	2,5	80	811/630	-	-	-	-
	6	5	295	812/630	-	-	-	-

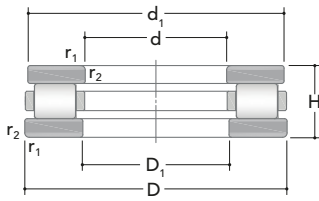

81M

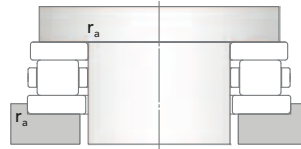

Main dimensions					Basic load ratings		Fatigue load limit C_u	Speed ratings		Designation Standard design
d	D	H	d1	D1	Dynamic C	Static C_0		Reference	Limiting	
[mm]					[kN]		[rpm]			
650	920	140	920	655	5402	37680	2340	90	120	358130
	930	130	930	650	5419	37460	2353	90	120	358162
655	765	45	765	650	1171	8950	553	280	-	634147
670	800	78	795	675	1999	13380	816	200	390	891/670
	800	105	795	675	2567	16160	988	180	350	811/670
	900	180	892	678	5759	30320	1811	130	250	812/670
673,227	876,173	111,125	876,173	673,227	4110	25540	1558	180	-	464790
710	850	85	845	715	2196	14860	908	180	350	891/710
	850	112	845	715	2937	18060	1135	170	330	811/710
	950	190	942	718	5910	31580	1854	120	230	812/710
711,327	964,26	127,127	964,26	711,327	5276	35340	2119	170	-	475623
750	900	90	895	755	2374	16530	1004	170	330	891/750
	900	120	895	755	3213	21040	1260	150	300	811/750
	1000	195	992	758	6573	35370	2117	110	210	812/750
762,127	964,946	111,125	964,946	762,127	4354	28530	1687	170	-	464789
780	890	50	890	780	1180	9830	580	240	-	634055
800	950	90	945	805	2505	17750	1055	170	340	891/800
	950	120	945	805	3468	21770	1304	150	290	811/800
	1060	205	1050	810	7415	40490	2281	100	190	812/800
812,8	1016	127,127	1016	812,8	5242	33680	1948	150	-	464973
850	1000	90	995	955	2576	18840	1109	170	310	891/850
	1000	120	995	855	3449	22910	1357	150	280	811/850



TCRBU

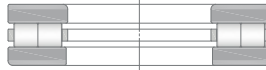

89M

Dimensions			Mass	Designation	Designation of components			
d	r _{1,2min}	r _{amax}			Standard design	Roller thrust cage assembly	Washer type Shaft	Housing
[mm]			[kg]					
650	6	5	325	358130	-	-	-	-
	4	3	315	358162	-	-	-	-
655	1,9	1,5	39	634147	-	-	-	-
670	4	3	75,5	891/670	-	-	-	-
	4	3	110	811/670	-	-	-	-
	6	5	335	812/670	-	-	-	-
673,227	4	3	185	464790	-	-	-	-
710	4	3	95	891/710	-	-	-	-
	4	3	155	811/710	-	-	-	-
	6	5	395	812/710	-	-	-	-
711,327	7,6	7	300	475623	-	-	-	-
750	4	3	115	891/750	-	-	-	-
	4	3	155	811/750	-	-	-	-
	6	5	445	812/750	-	-	-	-
762,127	4	3	210	464789	-	-	-	-
780	1,5	1,5	52	634055	-	-	-	-
800	4	3	120	891/800	-	-	-	-
	4	3	165	811/800	-	-	-	-
	7,5	6	515	812/800	-	-	-	-
812,8	2,3	2	250	464973	-	-	-	-
850	4	3	130	891/850	-	-	-	-
	4	3	170	811/850	-	-	-	-

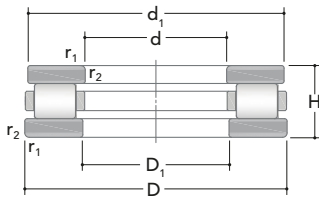

81M

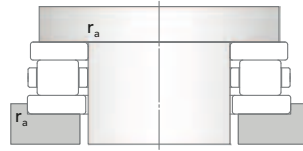

Main dimensions					Basic load ratings		Fatigue load limit C_u	Speed ratings		Designation Standard design
d	D	H	d1	D1	Dynamic C	Static C_0		Reference	Limiting	
[mm]					[kN]			[rpm]		
850	1120	212	1110	860	8189	45100	2573	100	190	812/850
(cont.)										
900	1060	95	1055	905	3021	21850	1259	150	300	891/900
	1060	130	1054	906	3952	26950	1503	140	270	811/900
	1180	220	1170	910	8482	48380	2684	90	170	812/900
950	1120	103	1115	955	3416	24810	1411	150	-	891/950
	1120	135	1114	956	4452	29700	1646	130	-	811/950
950	1250	236	1240	960	9878	57740	3191	80	160	812/950
980	1120	120	1115	985	3176	21770	1233	-	-	
1000	1090	70	1090	1003,5	1852	15100	861	-	-	351585
	1120	52	1120	1000	1591	13810	745	-	-	634146
	1180	109	1175	1005	3883	28340	1569	-	-	891/1000
	1160	140	1174	1006	4737	32470	1762	-	-	811/1000
	1320	250	1308	1012	10239	59380	3233	-	-	812/1000
1003,35	1117,6	50,8	1117,6	1003,35	1958	18290	1017	-	-	358391
1060	1250	115	1245	1065	4209	30520	1686	-	-	891/1060
	1250	150	1244	1066	5331	36130	1950	-	-	811/1060
	1400	265	1388	1972	11949	70210	3691	-	-	812/1060
1120	1320	122	1315	1125	4840	36390	1906	-	-	891/1120
	1320	160	1314	1126	6000	40720	2201	-	-	811/1120
1200	1660	300	1655	1205	20663	124900	6304	-	-	358235
1280	1400	60	1396	1284	1703	18880	956	-	-	634152



TCRBU



89M

Dimensions			Mass	Designation	Designation of components			
d	r _{1,2min}	r _{amax}			Standard design	Roller thrust cage assembly	Washer type	
[mm]			[kg]			Shaft	Housing	
850	7,5	6	580	812/850	-	-	-	-
(cont.)								
900	5	4	150	891/900	-	-	-	-
	5	4	210	811/900	-	-	-	-
	7,5	6	665	812/900	-	-	-	-
950	5	4	185	891/950	-	-	-	-
	5	4	250	811/950	-	-	-	-
950	7,5	6	805	812/950	-	-	-	-
980	5	4	180		-	-	-	-
1000	2,1	2	68	351585	-	-	-	-
	2,1	2	75	634146	-	-	-	-
	5	4	220	891/1000	-	-	-	-
	5	4	285	811/1000	-	-	-	-
	9,5	8	965	812/1000	-	-	-	-
1003,35	2	2	64,5	358391	-	-	-	-
1060	5	4	260	891/1060	-	-	-	-
	5	4	225	811/1060	-	-	-	-
	9,5	8	1150	812/1060	-	-	-	-
1120	5	4	305	891/1120	-	-	-	-
	5	4	410	811/1120	-	-	-	-
1200	6	5	2140	358235	-	-	-	-
1280	3	2,5	102	634152	-	-	-	-

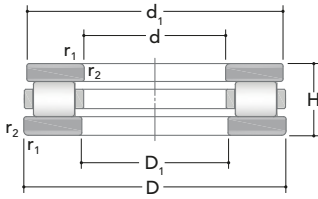

81M

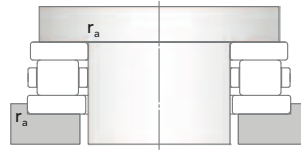

Main dimensions					Basic load ratings		Fatigue load limit C_u	Speed ratings		Designation Standard design
d	D	H	d1	D1	Dynamic C	Static C_0		Reference	Limiting	
[mm]					[kN]			[rpm]		
1400	1520	52	1515	1405	1815	23240	1178	-	-	358156
	1640	150	1632	1408	6113	47800	2330	-	-	358316
1560	1650	57	1650	1560	773	8030	396	-	-	358395
1680	1800	75	1796	1684	2118	23580	1081	-	-	634150
1750	1895	76	1890	1755	3157	41120	1918	-	-	358157
2130	2250	76	2245	2135	2351	10070	3495	-	-	634099
2305	2450	76	2445	2310	3784	53920	2283	-	-	358158
2540	2700	80	2695	2545	4370	62730	2704	-	-	358155



TCRBU

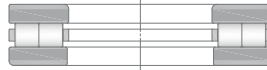

89M

Dimensions			Mass	Designation	Designation of components			
d	r _{1,2min}	r _{amax}			Standard design	Roller thrust cage assembly	Washer type Shaft	Housing
[mm]			[kg]					
1400	2	2	97	358156	-	-	-	-
	6	5	575	358316	-	-	-	-
1560	2	2	97	358395	-	-	-	-
1680	4	3	175	634150	-	-	-	-
1750	3	2,5	215	358157	-	-	-	-
2130	3	2,5	235	634099	-	-	-	-
2305	3	2,5	285	358158	-	-	-	-
2540	3	2,5	365	358155	-	-	-	-

Double direction cylindrical roller thrust bearings

Double direction cylindrical roller thrust bearings are composed of two housing washers GS, one shaft washers WS and two cage-cylindrical rollers assemblies. Bearings are separable so washers and axial cylindrical roller and cage-cylindrical rollers assemblies can be mounted separately to ease the operations. These bearings are characterized by a very high load capacity and high stiffness. They can support axial loads in both direction and are not able to withstand radial force and tilting moments.

The main boundary dimensions of axial cylindrical roller bearings are in conformity with ISO 104:2015. They are manufactured with tolerances according to ISO 199:2014.



Misalignment

Thrust roller bearings do not allow any misalignment between shaft and housing and any alignment errors between support surfaces in the housing and on the shaft.

Minimum load

A minimum axial load is requested for a thrust roller bearing, like for all roller bearings, to operate correctly, especially in particularly application requirements like: high speed, high acceleration and sudden changes of direction. In these operating conditions a sliding movement between the rollers and raceways can be generated by the inertial forces, influencing negatively the bearing life. To calculate the minimum axial load please consult the RKB application engineering service.

However, the minimum axial load is reached or surpassed by the weight of the components supported by the bearing, mostly when the shaft is vertical and the loads acting on it. If the minimum axial load is not reached or in case of application where a starting up at low temperature is planned or a lubricant with high viscosity is used, it will be necessary to preload the cylindrical roller thrust bearings by springs or shaft nut.

Designs and variants

Type WS+GS

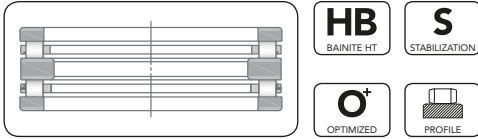

- Flat housing washers
- Separable components unit: shaft washers (WS) plus housing washers (GS)
- Two-piece machined brass cage (M) guided on rollers
- Sensitive to misalignments
- Supports very high bidirectional axial loads

Tapered roller thrust bearings

The tapered roller thrust bearings manufactured by RKB are designed to support very high axial loads and even moderate shock loads. Their particular design features a true rolling motion, minimizing roller friction and allowing a better running compared to other thrust bearings. According to this feature, tapered roller thrust bearings meet any requirements in various industrial applications. Thanks to the improved internal geometry and the use of the most suitable raw materials, all RKB TBs attain the highest axial load ratings and the best reliability. Depending on application requirements, RKB Bainite Hardening Treatment (HB) and High Temperature Dimensional Stabilization (S) can be applied on bearing rings and rolling elements. The bearing dimensional and running accuracy conforms to ISO/ ABMA/ GOST specifications.



Single direction tapered roller thrust bearings

Single direction tapered roller thrust bearings are produced in three different designs. The first one features a shaft washer with a tapered raceway, a two-piece machined brass cage, one row of tapered rollers and a flat housing washer. They have a separable design so, washers and cage-tapered roller assembly can be mounted separately. They can accommodate axial forces only in one direction and are able to accept a small eccentricity between shaft and housing without compromising their performances.

The second design has two identical tapered washers and a two-piece machined brass cage. It has a separable design so, washers and cage-tapered roller assembly can be mounted separately. This configuration is normally suggested where very heavy axial loads acting only in one direction have to be supported. On request for an increased carrying capacity, a full complement (cageless design) can be manufactured.

Bearing TKSD design for screw down mechanism is subjected to extremely heavy axial loads in one direction and, in order to maximize the load carrying capacity, this kind of bearing is normally full complement (cageless). Moreover, they have to be able to permit angular movement of the screw spindle respect to the support without affect negatively the bearing life. The angular movement may be accommodated by one sphered washer, that can be either shaft washer or housing washer. The pressure plate can be supplied by RKB.

Misalignment

Tapered roller thrust bearings do not allow any misalignment between shaft and housing and any alignment errors between support surfaces in the housing and on the shaft.

Minimum load

A minimum axial load is requested for a tapered roller thrust bearing, like for all roller bearings, to operate correctly, especially in particularly application requirements like: high speed, high acceleration and sudden changes of direction. In these operating conditions a sliding movement between the rollers and raceways can be generated by the inertial forces, influencing negatively the bearing life. To calculate the minimum axial load please consult the RKB application engineering service.

However, the minimum axial load is reached or surpassed by the weight of the components supported by the bearing, mostly when the shaft is vertical and the loads acting on it. If the minimum axial load is not reached or in case of application where a starting up at low temperature is planned or a lubricant with high viscosity is used, it will be necessary to preload the tapered roller thrust bearings by springs or shaft nut.

Designs and variants

Type TK₁

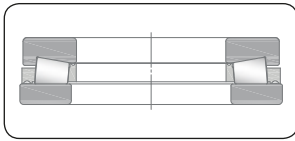

HB BAINITE HT	S STABILIZATION
O⁺ OPTIMIZED	PROFILE PROFILE

- Support unidirectional axial loads
- Tapered raceway on shaft washer and flat on housing washer
- Cage guided on both washers
- Optimized roller profile

Type TK₄

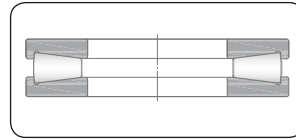

HB BAINITE HT	S STABILIZATION
R⁺ REINFORCED	PROFILE PROFILE

- Full complement (cageless) design for increased carrying capacities
- Support unidirectional axial loads
- Symmetrical washers featuring taper raceway
- Optimized roller profile

Type TK₂

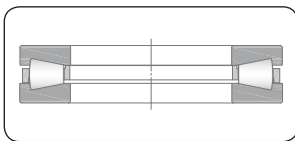

HB BAINITE HT	S STABILIZATION
R⁺ REINFORCED	PROFILE PROFILE

- Support unidirectional axial loads
- Cage guided on washers
- Symmetrical washers featuring taper raceway
- Optimized roller profile

Type TK₃



HB BAINITE HT	S STABILIZATION
R⁺ REINFORCED	PROFILE PROFILE

- Support unidirectional axial loads
- Cage guided on rollers
- Symmetrical washers featuring taper raceway
- Optimized roller profile

Type TKSD₁

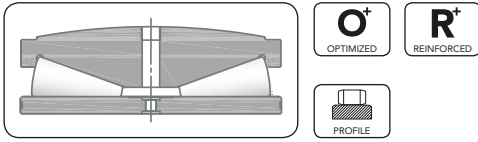

- Full complement (cageless) design, conceived for extremely high axial loads
- Special execution for screw-down mechanism
- Convex sphered shaft washer outer surface (suitable for concave screw spindles)
- Designed to accommodate misalignment angle on the sphered surface
- Optimized roller profile

Type TKSD₂

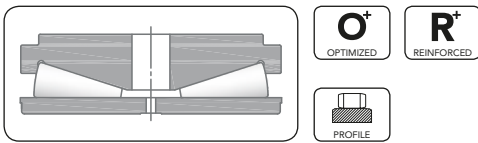

- Full complement (cageless) design, conceived for extremely high axial loads
- Special execution for screw-down mechanism
- Flat shaft washer outer surface
- No misalignment angle can be accommodated
- Optimized roller profile

Type TKSD₃

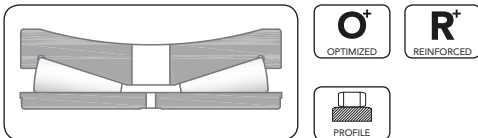

- Full complement (cageless) design, conceived for extremely high axial loads
- Special execution for screw-down mechanism
- Concave sphered shaft washer outer surface (suitable for convex screw spindles)

- Designed to accommodate misalignment angle on the sphered surface
- Optimized roller profile

Type TKSD₄

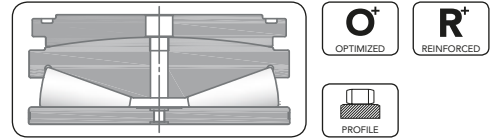

- Full complement (cageless) design, conceived for extremely high axial loads
- Special execution for screw-down mechanism
- Convex sphered shaft washer outer surface, mating a concave sphered pressure plate surface
- Designed to accommodate misalignment angle
- Optimized roller profile

Type TKSD₅

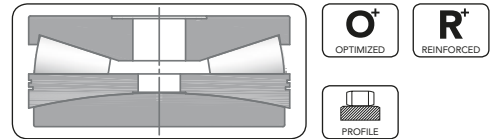

- Full complement (cageless) design, conceived for extremely high axial loads
- Special execution for screw-down mechanism
- Concave sphered housing washer outer surface, mating a convex sphered pressure plate surface
- Designed to accommodate misalignment angle
- Optimized roller profile

Suffixes	Internal design
ZB	Optimized roller profile for improved load distribution. It is not necessarily stated in the bearing code

Prefixes	Alternative designation
TK	Out of standard single direction tapered roller thrust bearing followed by drawing number
TKFL	Out of standard single direction tapered roller thrust bearing with flat shaft washer followed by drawing number
TTK	Out of standard double direction tapered roller thrust bearing followed by drawing number
TKSD	Out of standard screw-down bearing followed by drawing number

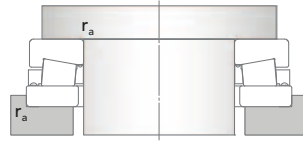
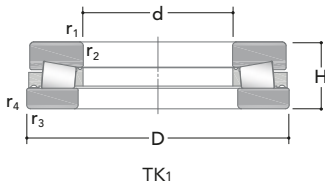

Main dimensions			Basic load ratings		Fatigue load limit C_u	Designation Standard design
d	D	H	Dynamic C	Static C_0		
[mm]			[kN]			
100	260	65	1150,00	4700	350	351137
120	300	75	1500,0	6280	430	351139
	300	79	2100,0	6570	540	353332
140	230	75	630,0	1914	175	350726
177,8	368,3	82,55	2400,0	10200	710	353286
180	500	145	5530,0	25300	1540	353022
190	330	77	1480,0	5770	460	353348
220	500	125	3540,0	15700	980	351148
260	580	145	4650	21000	1230	351153
279,4	603,25	136,525	7150,0	28400	1800	353316
290	400	73	1070,0	4630	335	350888
300	660	165	5920	26600	1520	351195
	660	165	6630,0	27800	1740	353916
340	460	73	1230,0	5660	405	350565
347,5	710	160	7830,0	39200	2300	351468
370	560	115	3570,0	14100	1050	353205
380	560	110	2860,0	11900	850	353164
480	730	112	3630,0	18800	1180	350998



TK2

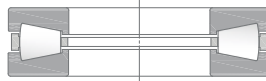

TK3



TK4

Dimensions				Mass	Designation
d	r _{1,2min}	r _{3,4min}	r _{amax}		Standard design
[mm]				[kg]	
100	4	4	3	20,5	351137
120	5	5	3	33,5	351139
	4,8	4,8	4	30	353332
140	2,1	2,1	2	14,5	350726
177,8	8	8	6	47	353286
180	6	6	5	195	353022
190	3,3	3,3	3	30	353348
220	7,5	7,5	6	160	351148
260	7,5	7,5	6	210	351153
279,4	4,8	4,8	4	205	353316
290	3	3	2,5	32,5	350888
300	7,5	7,5	6	350	351195
	10	10	9	315	353916
340	3	3	2,5	37	350565
347,5	4	4	3	345	351468
370	5	5	4	110	353205
380	3	3	2,5	110	353164
480	6	6	5	180	350998

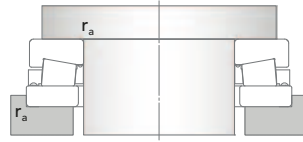
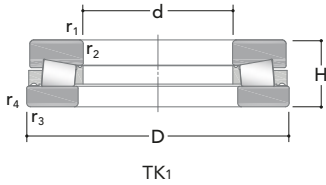

Main dimensions			Basic load ratings		Fatigue load limit C_u	Designation Standard design
d	D	H	Dynamic C	Static C_0		
[mm]			[kN]			
558,8	1066,8	285,75	19520,0	73700	4200	353285
600	900	170	6970,0	32000	1900	353201
749,3	952,5	127	5830,0	29800	1750	353247
840	1140	195	11250	63100	3450	351573
1002	1274	150	9100	56400	3050	353901
1005	1280	150	8330	50900	2650	353210
1770	1930	80	3250,0	31700	1400	353312
1828,8	2184,4	203,2	20200,0	141000	6300	353320



TK2

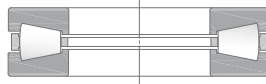

TK3



TK4

Dimensions				Mass	Designation
d	r _{1,2min}	r _{3,4min}	r _{amax}		Standard design
[mm]				[kg]	
558,8	12,7	–	12	1200	353285
600	7,5	7,5	6	405	353201
749,3	5	2,5	4	230	353247
840	7,5	7,5	6	575	351573
1002	7,5	7,5	6	465	353901
1005	7,5	7,5	6	505	353210
1770	5	5	4	250	353312
1828,8	10,2	10,2	9	1450	353320

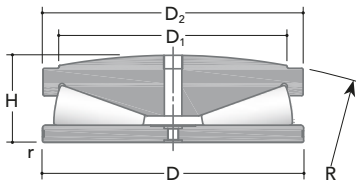

TKSD1

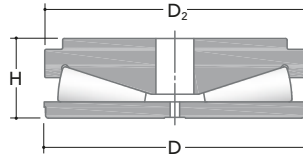

TKSD2

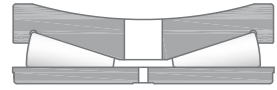

TKSD3

Main dimensions					Basic load rating	Dimensions	Mass	Designation
D	D ₁	D ₂	H	R	Static C ₀	r _{min}		Standard design
[mm]					[kN]	[mm]	[kg]	
203,2	177,8	200,84	75620	508	3930,00	1,6	16,5	353108
266,7	228,6	264,34	94,41	609,6	7070,0	1,6	35,5	353038
320,68	279,4	318,31	110,97	762	10250,0	1,6	61,5	353065
377,83	330,2	375,46	129,01	914,4	14890,0	1,6	96	353107
409,58	355,6	407,21	140,77	1016	16980,0	3,2	125	353058
438,15	381	435,79	150,67	1016	19860,0	3,2	170	353059
495,3	431,8	492,94	170,61	1066,8	25960	3,2	205	353024
	431,8	492,94	170,61	1066,8	25960,0	3,2	205	353295
508	440	504,825	177,419	1143	30970	2,5	225	353322
523,875	457,2	521,51	175,77	1270	29930,0	3,2	245	353020
533,4	457,2	533,4	177,8	1981,2	30380,0	3,2	280	353129
555,63	482,6	553,26	190,86	1270	33090	3,2	275	616674
	482,6	553,26	190,86	1270	33090,0	3,2	275	353078
	482,6	553,26	205,74	1270	33190,0	3,2	305	353260
581,03	508	578,66	193,78	1422,4	37270,0	3,2	290	353124
	508	578,66	196,65	1308,1	37270,0	3,2	330	353288
609,6	533,4	607,24	204,01	1524	38930,0	3,2	400	353093
	-	607,24	177,038	-	38930,0	3,2	375	353262
641,35	560	638,99	178,1	1524	44690,0	3,2	455	353134

Main dimensions					Basic load rating	Dimensions	Mass	Designation
D	D ₁	D ₂	H	R	Static C ₀	r _{min}		Standard design
[mm]					[kN]	[mm]	[kg]	
920	830	920	280	2300	91590	7,5	1180	353193

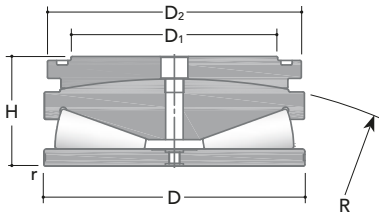

TKSD4

Main dimensions					Basic load rating	Dimensions	Mass	Designation
D	D ₁	D ₂	H	R	Static C ₀	r _{min}		Standard design
[mm]					[kN]	[mm]	[kg]	
174,63	150	173	76	457,2	2950,0	1,5	12	353305
203,2	170	200	90	508	3950,0	1,1	16,5	353108
266,7	225	264,34	120	609,6	7050,0	1,6	47	353038
409,58	355	410	188	1016	17000,0	3,2	170	353058
533,4	410	500	245	1981,2	30400,0	3,2	360	353129
581,03	460	565	243,78	1422,4	37000,0	3,2	400	353124
	500	570	243,78	1422,4	37000	3,2	425	353124
609,6	585	710	254,01	1524	38500,0	3,2	565	353093
641,35	560	635	260	1524	44200,0	3,2	560	353134
920	768	915	370	2300	92000,0	7,5	1700	353195

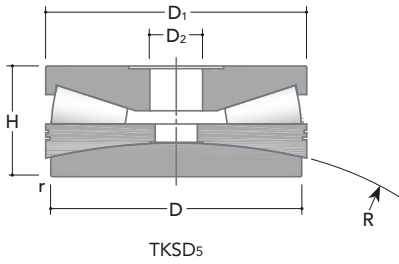

Main dimensions					Basic load rating	Dimensions	Mass	Designation
D	D ₁	D ₂	H	R	Static C ₀	r _{min}		Standard design
[mm]					[kN]	[mm]	[kg]	
476	495,3	100	210	1075	25700,0	-	310	353075
515	520	60	220	1160	35600,0	3,3	290	353231
571,5	581,03	-	240,77	1270	34900,0	-	460	353067
582,625	609,6	-	249,96	1270	38400,0	3	410	353142
	670	-	248,46	1270	42500,0	3	530	353903
740	800	340	320	1500	45300,0	8	1010	353070
775	850	340	360	1500	56600	5	1330	353045
830	900	320	390	1500	80900,0	10	1640	353029

Double direction tapered roller thrust bearings

Double direction tapered roller thrust bearings (TTK) can support high bidirectional axial loads and are able to accommodate a small eccentricity between shaft and housing, without affecting negatively their performance. Due to a large number of tapered rollers, this bearing has also a high rigidity. TTK is available in two main configurations. The first one has two tapered housing washers, a flat shaft washer, two tapered rows of rollers and two two-pieced machined brass cage guided on shaft washer. A spacer sleeve is arranged between the two housing washers in order to adjust the correct Bench End Play (BEP) requested by the customer. A second version has an intermediate washer with external housing centering. Both bearings designs are separable, so washers, cage-tapered rollers assemblies and spacer sleeve can be mounted separately.



Misalignment

Double direction tapered roller thrust bearings featuring a flat washer do not allow any misalignment of the shaft as well as any other perpendicular error of the supporting parts.

Minimum load

A minimum axial load is requested for a double tapered roller thrust bearing, like for all roller bearings, to operate correctly, especially in particularly application requirements like: high speed, high acceleration and sudden changes of direction. In these operating conditions a sliding movement between the rollers and raceways can be generated by the inertial forces, influencing negatively the bearing life. To calculate the minimum axial load please consult the RKB application engineering service.

However, the minimum axial load is reached or surpassed by the weight of the components supported by the bearing, mostly when the shaft is vertical and the loads acting on it. If the minimum axial load is not reached or in case of application where a starting up at low temperature is planned or a lubricant with high viscosity is used, it will be necessary to preload the tapered roller thrust bearing by springs or shaft nut.

For additional information, please consult the RKB application engineering service.

Designs and variants

Type TTK₁



HB BAINITE HT	S STABILIZATION
 PROFILE	R⁺ REINFORCED

- Separable compact units
- Two-piece machined brass cage (M) guided on shaft washer (intermediate washer)
- Intermediate washer with internal centering on shaft
- Preset or adjusted BEP on customer's request
- Very sensitive to misalignments
- Supports very high bidirectional axial loads
- Available with lubrication grooves and holes in outer spacer

Type TTK₂

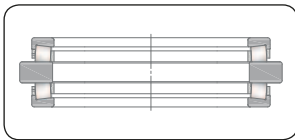

HB BAINITE HT	S STABILIZATION
 PROFILE	R⁺ REINFORCED

- Low cross section separable compact units
- Two-piece machined brass cage (M) guided on shaft washer (intermediate washer)
- Intermediate washer with external centering on the housing
- Very sensitive to misalignments
- Supports very high bidirectional axial loads

Type TTK_{SP}

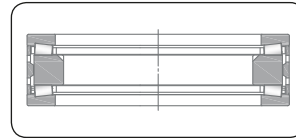

HB BAINITE HT	S STABILIZATION
 PROFILE	R⁺ REINFORCED

- Separable compact units
- Two-piece machined brass cage (M) guided on shaft washer (intermediate washer)
- Shaft washer with internal centering on shaft
- Preset or adjusted BEP on customer's request
- Very sensitive to misalignments
- Support very high bidirectional axial loads
- Available with lubrication grooves and holes in outer spacer

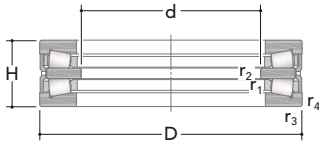

TTK₁

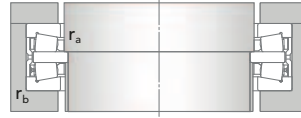

Main dimensions			Basic load ratings		Fatigue load limit	Designation
d	D	H	Dynamic C	Static C ₀	C _u	Standard design
[mm]			[kN]			
170	240	84	325,0	1300	103	350980
180	280	90	560,0	2350	197	353162
220	300	96	435,0	1650	133	351019
240	320	96	420,0	1880	145	351182
250	380	100	910,0	4500	340	353005
260	360	92	600,0	2650	190	350981
270	450	180	1645	5900	460	351164
305,07	530	200	2395,0	10500	685	353194
320	440	108	1000,0	4900	340	353102
	470	130	1320,0	5650	410	350982
350	490	130	1150,0	5100	345	351100
	540	135	1700	9100	625	353006
380	560	130	1800,0	9900	675	351175
	650	215	3350,0	16300	1080	353204
400	650	200	2750,0	13500	825	353106
420	620	170	2400,0	12100	805	351121
	620	185	2400,0	12120	805	353200
440	645	167	1950,0	10640	705	353152
450	645	155	1950,0	10900	690	350916



TTK2



TTKSP

Dimensions					Mass	Designation
d	r _{1,2min}	r _{3,4min}	r _{amax}	r _{bmax}		Standard design
[mm]					[kg]	
170	0,6	2	0,6	2	12,5	350980
180	1	2	1	2	22	353162
220	0,6	2	0,6	2	20	351019
240	0,6	2	0,6	2	21,5	351182
250	0,6	2	0,6	2	43,5	353005
260	1	2	1	2	28	350981
270	2	5	2	4	120	351164
305,07	6,4	6,4	6	6	185	353194
320	1,1	3	1	2,5	48,5	353102
	1,1	3	1	2,5	80	350982
350	1,1	3	1	2,5	73,5	351100
	1,1	4	1	3	115	353006
380	1,5	3	1,5	2,5	110	351175
	2	4	2	3	275	353204
400	4	4	4	4	235	353106
420	1,5	3	1,5	3	185	351121
	1,5	3	1,5	3	200	353200
440	3	4	2,5	3	190	353152
450	4	4	3	3	170	350916

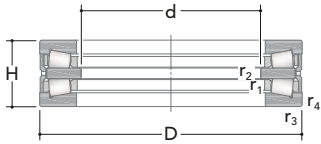

TTK₁

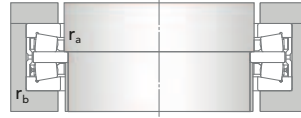

Main dimensions			Basic load ratings		Fatigue load limit	Designation
d	D	H	Dynamic C	Static C ₀	C _u	Standard design
[mm]			[kN]			
470	720	200	3350,0	17540	1100	353151
	720	200	3450,0	17540	1100	351301
	720	210	3400,0	17540	1100	353238
530	710	218	2170,0	10890	700	351475
550	760	230	2950	13100	835	350976
600	880	290	4750	20940	1280	350824
	910	290	4750,0	21110	1280	350901
670	900	230	3550	18640	1140	351761



TTK2



TTKSP

Dimensions					Mass	Designation
d	r _{1,2min}	r _{3,4min}	r _{amax}	r _{bmax}		Standard design
[mm]					[kg]	
470	2	4	2	3	285	353151
	2	4	2	3	285	351301
	2	4	2	3	305	353238
530	2	3	2	2,5	245	351475
550	2	5	2	4	310	350976
600	5	6	4	5	550	350824
	5	6	4	5	655	350901
670	2	5	2	4	425	351761

Spherical roller thrust bearings

The spherical roller thrust bearings manufactured by RKB are designed to support high axial loads and, in some cases, even moderate radial loads. The manufacturing program includes single and double direction spherical roller thrust bearings to meet any requirements in various industrial applications. Thanks to the improved internal geometry and the use of the most suitable raw materials, all RKB TBs attain the highest axial load ratings and the best reliability. Depending on application requirements, RKB Bainite Hardening Treatment (HB) and High Temperature Dimensional Stabilization (S) can be applied on bearing rings and rolling elements. The bearing dimensional and running accuracy conforms to ISO/ABMA/GOST specifications.

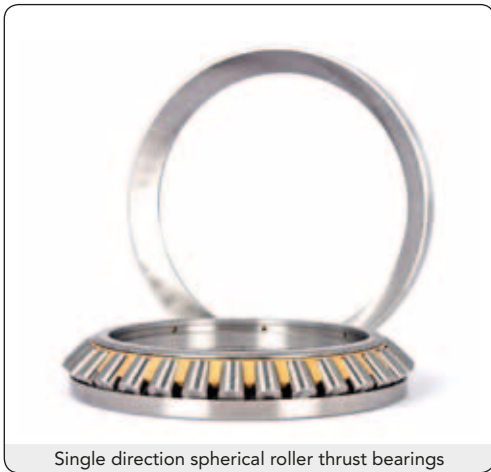

Single direction spherical roller thrust bearings

Single direction spherical roller thrust bearings

Single direction spherical roller thrust bearings are composed by a shaft washer, housing washer and one row of asymmetrical barrel roller with cage. They have a separable design: the cage, rollers and shaft washer together form an assembly, while the housing washer can be mounted separately.

Due to their raceways design, they are self-aligning, making the bearing insensitive to the shaft deflection or misalignment between shaft and housing. Axial spherical roller bearings can accommodate radial and unidirectional axial load acting simultaneously on it, even if they are suitable to work under heavy axial loads and high speed rotation.

They are manufactured mainly in three different configurations, depending on the bearing size. "EM type" with one piece machine brass cage guided on the shaft washer; "EMEVO type" has one piece "EVO" machine brass cage guided on the shaft where the axial forces are transmitted via the cage-guiding sleeve and "EJ type" with one high strength pressed steel cage guided on shaft washer.

In application where the "EMEVO type" bearing has to be replaced with "EM type" or "EJ type", it is necessary to insert a spacer sleeve between the shaft abutment and the shaft washer.

The main boundary dimensions of spherical roller bearings are in conformity with ISO 104:2015. They are manufactured with tolerances according to ISO 199:2014.

Misalignment

Due to its self alignment internal design, the spherical roller thrust bearings can accommodate misalignment between shaft and housing and a shaft bending during the operation. Full capacity of misalignment can be used when the shaft is rotating and the misalignment is constant.

Depending on the configuration, for example the presence of seals or the working conditions, the following values given in **Tab. 1** have to be reduced. Generally speaking the reduced values of misalignment have to be used when the load increases. Contact RKB application engineering service when:

- the housing washer is rotating with misalignment;
- shaft wobbles in relation to the housing.

Minimum load

A minimum axial load is requested for thrust roller bearings, like for all rolling bearings, to operate correctly, especially in particularly application requirements like: high speed, high acceleration and sudden changes of direction. In these operating conditions a sliding movement between the rollers and raceways can be generated by the inertial forces, influencing negatively the bearing life. To calculate the minimum axial load please consult the RKB application engineering service.

However, the minimum axial load is reached or surpassed by the weight of the components supported by the bearing, mostly when the shaft is vertical and the loads acting on it. If the minimum axial load is not reached or in case of application where a starting up at low temperature is planned or a lubricant with high viscosity is used, it will be necessary to preload the spherical roller thrust bearings by springs or shaft nut.

For additional information, please consult the RKB application engineering service.

Bearing series	Maximum misalignment for P or $P_0 < 0.05 \cdot C_{0a}$
292	$\pm 1.5^\circ$
293	$\pm 2.5^\circ$
294	$\pm 3^\circ$

Tab. 1 - Spherical roller thrust bearings max misalignment

Lubrication and mounting

RKB spherical roller thrust bearing feature a separable design, thus shaft washer with cage and roller assy can be mounted separately from housing washer. This kind of bearing can be lubricated both oil and grease. Due to its specific internal design a spherical roller thrust bearing features a pumping effect to allow the oil recirculation when mounted both on vertical shaft (**Fig. 1a**) and horizontal shaft (**Fig. 1b**).

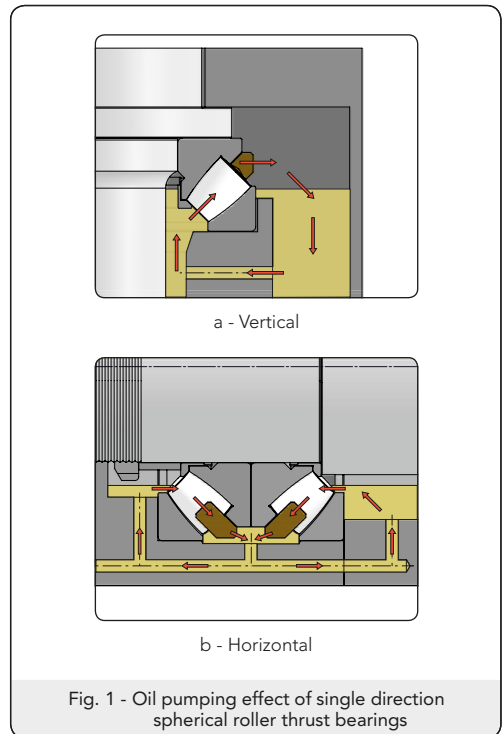
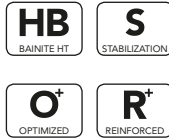
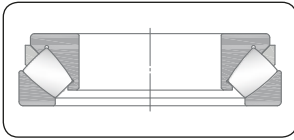

Fig. 1 - Oil pumping effect of single direction spherical roller thrust bearings

Designs and variants

Type EM



- Asymmetrical roller profile
- One-piece machined brass cage guided on rollers (M)
- Reinforced and optimized execution (E)
- Supports unidirectional axial loads and angular misalignment

- Supports unidirectional axial loads and angular misalignment

Type EJ

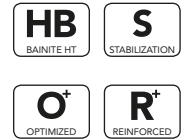
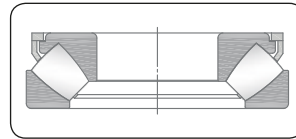

- Asymmetrical roller profile
- High strength pressed steel cage (J) guided on shaft washer
- Reinforced and optimized execution (E)
- Supports unidirectional axial loads and angular misalignment

Type EMB

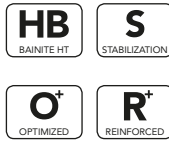
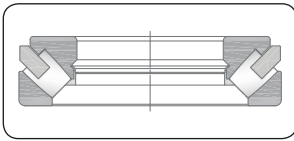

- Asymmetrical roller profile
- One-piece machined brass cage guided on rollers and featuring a retaining sleeve held in the shaft washer bore (MB)
- Reinforced and optimized execution (E)
- Supports unidirectional axial loads and angular misalignment

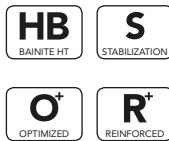
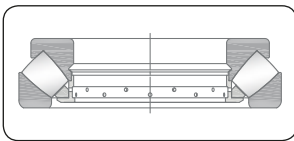
Type EM_{EVO}

- Asymmetrical roller profile
- One-piece EVO type machined brass cage guided by a retaining sleeve held in the shaft washer bore
- Reinforced and optimized execution (E)

Suffixes	Internal design
E	Optimized internal design with reinforced execution
EVO	Cage guided by a retaining sleeve held in the shaft washer bore
SP	Special or non-standard bearing
AOB	Application optimized bearing

Suffixes	Cage
M	Machined brass cage guided on rollers
MB	Machined brass cage guided on rollers and featuring a retaining sleeve held in the shaft washer bore
F	Machined steel cage
J	Pressed steel cage

Suffixes	External design
N1	One locating slot in housing washer
N2	Two locating slots in housing washer
EB	Lifting threaded holes for eye bolts in shaft washer

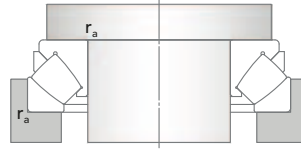
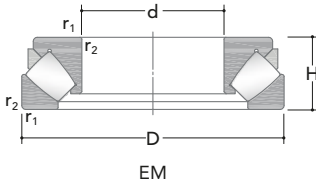

Main dimensions			Basic load ratings		Fatigue load limit C_u	Speed ratings		Designation Standard design
d	D	H	Dynamic C	Static C_0		Reference	Limiting	
[mm]			[kN]			[rpm]		
60	130	42	395	900	116	2600	4400	29412
65	140	45	450	1070	138	2400	4100	29413
70	150	48	525	1230	155	2300	3700	29414
75	160	51	610	1410	175	2300	3400	29415
80	170	54	660	1610	195	2100	3300	29416
85	150	39	385	1050	130	2300	3400	29317
	180	58	730	1790	215	1900	3100	29417
90	155	39	395	1070	133	2300	3500	29318
	190	60	810	1990	233	1800	2900	29418
100	170	42	455	1280	157	2100	3100	29320
	210	67	980	2460	280	1600	2600	29420
110	190	48	615	1720	205	1800	2800	29322
	230	73	1190	2970	328	1500	2500	29422
120	210	54	765	2080	250	1600	2400	29324
	250	78	1373	3440	375	1400	2200	29424
130	225	58	870	2480	280	1500	2300	29326
	270	85	1560	3990	435	1200	2100	29426
140	240	60	985	2820	318	1400	2300	29328
	280	85	1630	4342	450	1200	2100	29428
150	215	39	415	1570	183	1700	2400	29230
	250	60	995	2820	320	1400	2100	29330



EMB



EMevo

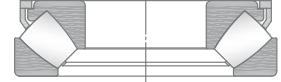

EJ

Dimensions			Mass	Designation
d	r _{1,2min}	r _{amax}		Standard design
[mm]			[kg]	
60	1,5	1,5	2,6	29412
65	2	2	3,2	29413
70	2	2	3,9	29414
75	2	2	4,7	29415
80	2,1	2	5,6	29416
85	1,5	1,5	2,75	29317
	2,1	2	6,75	29417
90	1,5	1,5	2,85	29318
	2,1	2	7,75	29418
100	1,5	1,5	3,65	29320
	3	2,5	10,5	29420
110	2	2	5,3	29322
	3	2,5	13,5	29422
120	2,1	2	7,35	29324
	4	3	17,5	29424
130	2,1	2	9	29326
	4	3	22	29426
140	2,1	2	10,5	29328
	4	3	23	29428
150	1,5	1,5	4,3	29230
	2,1	2	11	29330

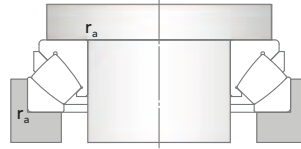
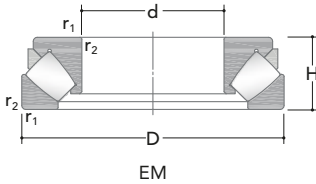

Main dimensions			Basic load ratings		Fatigue load limit C_u	Speed ratings		Designation Standard design
d	D	H	Dynamic C	Static C_0		Reference	Limiting	
[mm]			[kN]			[rpm]		
150	300	90	1880	5050	525	1100	1900	29430
(cont.)								
160	270	67	1170	3440	378	1200	1900	29332
	320	95	2090	5510	580	1000	1700	29432
170	280	67	1190	3510	370	1200	1900	29334
	340	103	2350	6430	650	1000	1700	29434
180	250	42	500	2020	215	1500	2300	29236
	300	73	1400	4240	445	1100	1700	29336
	360	109	2650	7210	725	950	1600	29436
190	320	78	1650	4660	500	1000	1600	29338
	380	115	2800	7900	775	900	1500	29438
200	280	48	660	2640	285	1300	1900	29240
	340	85	1850	5490	550	950	1500	29340
	400	122	3150	8970	855	800	1400	29440
220	300	48	680	2980	312	1200	1900	29244
	360	85	1980	6190	620	970	1500	29344
	420	122	3390	9530	910	820	1300	29444
240	340	60	790	3410	339	1000	1600	29248
	380	85	2000	6540	630	950	1400	29348
	440	122	3400	10110	940	800	1300	29448
260	360	60	820	3650	345	1000	1500	29252
	420	95	2500	8200	790	820	1200	29352
	480	132	4100	12800	1090	720	1100	29452
280	380	60	850	4000	375	970	1500	29256
	440	95	2550	8600	805	820	1200	29356



EMB



EMevo

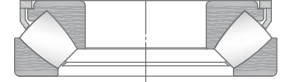

EJ

Dimensions			Mass	Designation
d	r _{1,2min}	r _{amax}		Standard design
[mm]			[kg]	
150	4	3	28	29430
(cont.)				
160	3	2,5	14,5	29332
	5	4	32	29432
170	3	2,5	15	29334
	5	4	44,5	29434
180	1,5	1,5	5,8	29236
	3	2,5	19,5	29336
	5	4	52,5	29436
190	4	3	23,5	29338
	5	4	60,5	29438
200	2	2	9,3	29240
	4	3	28,5	29340
	5	4	72	29440
220	2	2	10	29244
	4	3	31	29344
	6	5	75	29444
240	2,1	2	16,5	29248
	4	3	35,5	29348
	6	5	80	29448
260	2,1	2	18,5	29252
	5	4	49	29352
	6	5	105	29452
280	2,1	2	19,5	29256
	5	4	53	29356

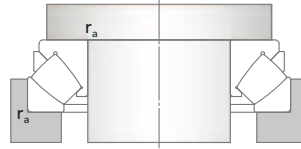
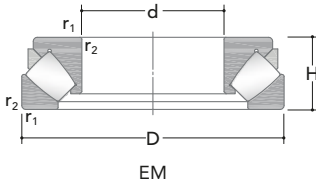

Main dimensions			Basic load ratings		Fatigue load limit C_u	Speed ratings		Designation Standard design
d	D	H	Dynamic C	Static C_0		Reference	Limiting	
[mm]			[kN]			[rpm]		
280	520	145	4850	15000	1350	640	1100	29456
(cont.)								
300	420	73	1060	4800	465	870	1200	29260
	480	109	3090	10400	950	720	1020	29360
	540	145	4950	16500	1350	640	1030	29460
320	440	73	1100	5000	475	820	1230	29264
	500	109	3370	11100	1000	720	1050	29364
	580	155	5700	18700	1550	570	970	29464
340	460	73	1150	5500	470	820	1120	29268
	540	122	2700	10900	960	580	940	29368
	620	170	6700	22100	1780	540	870	29468
360	500	85	1450	6700	595	720	1030	29272
	560	122	2750	11500	990	580	970	29372
	640	170	6180	20900	1650	540	830	29472
380	520	85	1550	7600	660	670	950	29276
	600	132	3350	13900	1170	500	870	29376
	670	175	6800	23600	1900	510	780	29476
400	540	85	1600	7900	700	670	950	29280
	620	132	3400	14500	1210	500	830	29380
	710	185	7600	26200	1980	460	740	29480
420	580	95	2000	9700	820	610	850	29284
	650	140	3750	15800	1300	480	790	29384
	730	185	7800	27000	2100	460	740	29484
440	600	95	2050	10300	860	610	870	29288
	680	145	5150	19000	1590	500	750	29388
	780	206	9050	31600	2350	410	660	29488



EMB



EMevo

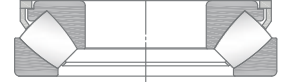

EJ

Dimensions			Mass	Designation
d	r _{1,2min}	r _{amax}		Standard design
[mm]			[kg]	
280	6	5	135	29456
(cont.)				
300	3	2,5	30,5	29260
	5	4	75	29360
	6	5	140	29460
320	3	2,5	33	29264
	5	4	78	29364
	7,5	6	175	29464
340	3	2,5	33,5	29268
	5	4	105	29368
	7,5	6	220	29468
360	4	3	52	29272
	5	4	110	29372
	7,5	6	230	29472
380	4	3	53	29276
	6	5	140	29376
	7,5	6	260	29476
400	4	3	55,5	29280
	6	5	150	29380
	7,5	6	310	29480
420	5	4	75,5	29284
	6	5	170	29384
	7,5	6	325	29484
440	5	4	78	29288
	6	5	180	29388
	9,5	8	410	29488

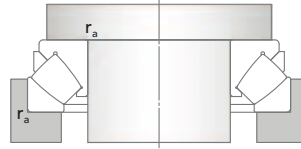
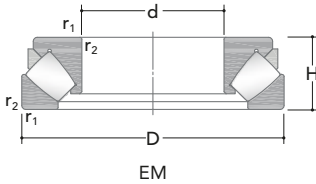

EM

Main dimensions			Basic load ratings		Fatigue load limit C_u	Speed ratings		Designation
d	D	H	Dynamic C	Static C_0		Reference	Limiting	
[mm]			[kN]			[rpm]		
460	620	95	2100	10500	870	570	810	29292
	710	150	4300	18700	1520	430	690	29392
	800	206	9300	33400	2460	410	650	29492
480	650	103	2370	11700	860	540	770	29296
	730	150	4250	19200	1480	430	600	29396
	850	224	9450	38400	2850	320	570	29496
500	670	103	2350	12300	1010	540	790	292/500
	750	150	4550	20100	1580	410	690	293/500
	870	224	9400	39600	2880	320	580	294/500
530	710	109	3100	15100	1230	510	730	292/530
	800	160	5800	26400	2090	390	660	293/530
	920	236	10300	43500	3150	310	560	294/530
560	750	115	3000	15800	1230	460	700	292/560
	980	250	12000	50100	3600	280	490	294/560
600	800	122	3750	18500	1460	430	610	292/600
	1030	258	13200	55200	4060	270	460	294/600
630	850	132	4800	23200	1830	380	570	292/630
	950	190	8300	37500	2950	310	520	293/630
	1090	280	14500	61300	4200	250	440	294/630
670	900	140	4200	22500	1680	350	480	292/670
	1150	290	15500	67800	4520	230	390	294/670
710	1060	212	10000	44900	3440	270	430	293/710
	1220	308	17800	76400	5000	210	370	294/710
750	1000	150	6000	30900	2330	320	420	292/750



EMB



EMevo

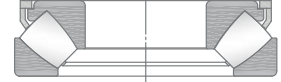

EJ

Dimensions			Mass	Designation
d	r _{1,2min}	r _{amax}		Standard design
[mm]			[kg]	
460	5	4	81	29292
	6	5	215	29392
	9,5	8	425	29492
480	5	4	98	29296
	6	5	220	29396
	9,5	8	550	29496
500	5	4	100	292/500
	6	5	235	293/500
	9,5	8	560	294/500
530	5	4	115	292/530
	7,5	6	270	293/530
	9,5	8	650	294/530
560	5	4	140	292/560
	12	10	810	294/560
600	5	4	170	292/600
	12	10	845	294/600
630	6	5	210	292/630
	9,5	8	485	293/630
	12	10	1040	294/630
670	6	5	255	292/670
	15	12	1210	294/670
710	9,5	8	610	293/710
	15	12	1500	294/710
750	6	5	325	292/750

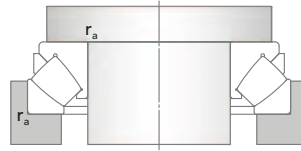
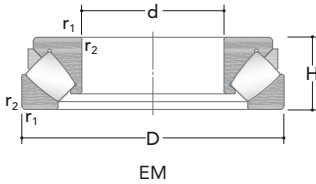

Main dimensions			Basic load ratings		Fatigue load limit C_u	Speed ratings		Designation Standard design
d	D	H	Dynamic C	Static C_0		Reference	Limiting	
[mm]			[kN]			[rpm]		
750 (cont.)	1120	224	9500	44400	3090	240	370	293/750
	1280	315	19920	84600	5530	190	350	294/750
800	1060	155	6500	34400	2560	310	470	292/800
	1180	230	11100	54000	3970	230	390	293/800
	1360	335	20200	92000	5910	180	320	294/800
850	1120	160	6600	35800	2560	280	400	292/850
	1440	354	23700	107000	7160	160	290	294/850
900	1180	170	7800	42000	3030	260	390	292/900
	1520	372	26600	121000	7260	150	260	294/900
950	1250	180	8150	45600	3090	250	350	292/950
	1600	390	28400	131000	7860	130	240	294/950
1000	1670	402	30700	137800	8800	120	230	294/1000
1060	1400	206	10600	58200	3750	210	310	292/1060
	1770	426	33800	155000	8600	110	210	294/1060
1180	1520	206	10900	62800	3800	210	300	292/1180
1250	1800	330	24500	128000	7600	120	210	293/1250
1600	2280	408	36700	196500	12000	85	140	293/1600



EMB



EMevo

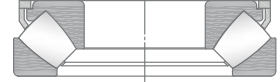

EJ

Dimensions			Mass	Designation
d	r _{1,2min}	r _{amax}		Standard design
[mm]			[kg]	
750	9,5	8	770	293/750
(cont.)	15	12	1650	294/750
800	7,5	6	380	292/800
	9,5	8	865	293/800
	15	12	2030	294/800
850	7,5	6	425	292/850
	15	12	2390	294/850
900	7,5	6	475	292/900
	15	12	2650	294/900
950	7,5	6	600	292/950
	15	12	3070	294/950
1000	15	12	3390	294/1000
1060	9,5	8	860	292/1060
	15	12	4280	294/1060
1180	9,5	8	950	292/1180
1250	12	10	2770	293/1250
1600	19	15	5380	293/1600

BB
ACBB
CRB
TRB
SRB
TORB
TBB
CRTB
TRTB
SRTB

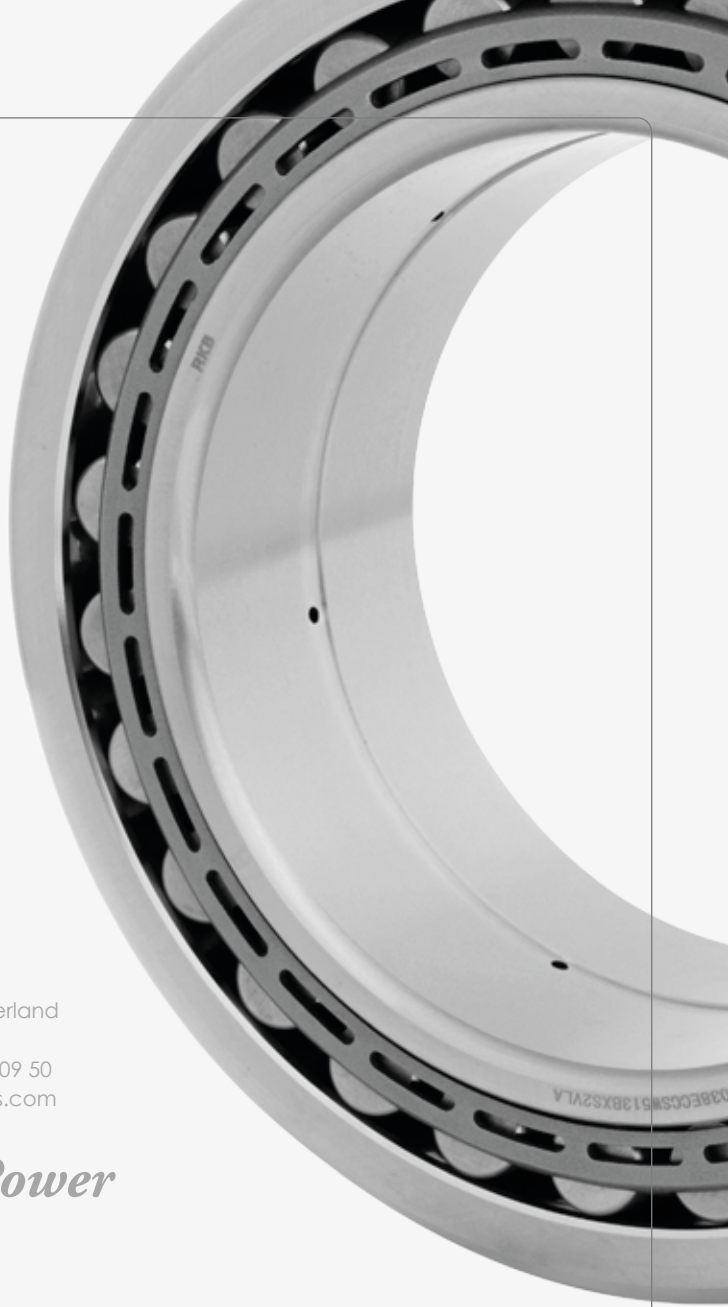

RKB

BEARING INDUSTRIES
SWITZERLAND

Via Primo Agosto 1 · 6828 Balerna · Switzerland
P.O. Box 16 · 6830 Chiasso 3 · Switzerland
Phone +41 91 260 09 30 · Fax +41 91 260 09 50
info@rkbeurope.com · www.rkbbearings.com

The Alternative Power

