



KG International

MOVING THE WORLD



KG® PRODUCT
CATALOGUE



RELIABLE | SUSTAINABLE | PERFORMANCE



Our Quality Statement

We at KGI are fully committed to offering a comprehensive range of bearings and power transmission solutions in major industrial segments, so that our valued customers can achieve better quality, better productivity, more profits and a higher level of competitiveness in their market.

We accomplish this by continuously striving to achieve a higher level of professionalism internally, enhanced service & support and by continuously improving our business processes.

KGI is also committed to supporting the communities within which we operate. We believe in the practice of social responsibility and encourage similar behaviour in our employees and external providers. We support the conservation of the physical environment and the prevention of wastage and pollution at our facilities.

Rohit Gupta - CEO
KG International FZCO

Welcome



Contents

Index of Contents

KGI Introduction	006
Bearings Introduction	014
History of Bearings	017
Classification and Types of Rolling Bearings	018
Design and Features of Rolling Contact Bearings	020
Selection of Rolling Contact Bearings	031
Material for Rolling Contact Bearings	033
Lubrication	036
Handling of Bearings	042
Bearing Failures	047
Bearing Data and Specifications	072
KG Bearings Portfolio	088
Appendix - Tables	446
Inch - mm Conversion Table	447
Hardness Conversion Table	449
kgf - N Conversion Table	450
kg - lb Conversion Table	451
°C - °F Conversion Table	452
International Units SI Conversion Table	453

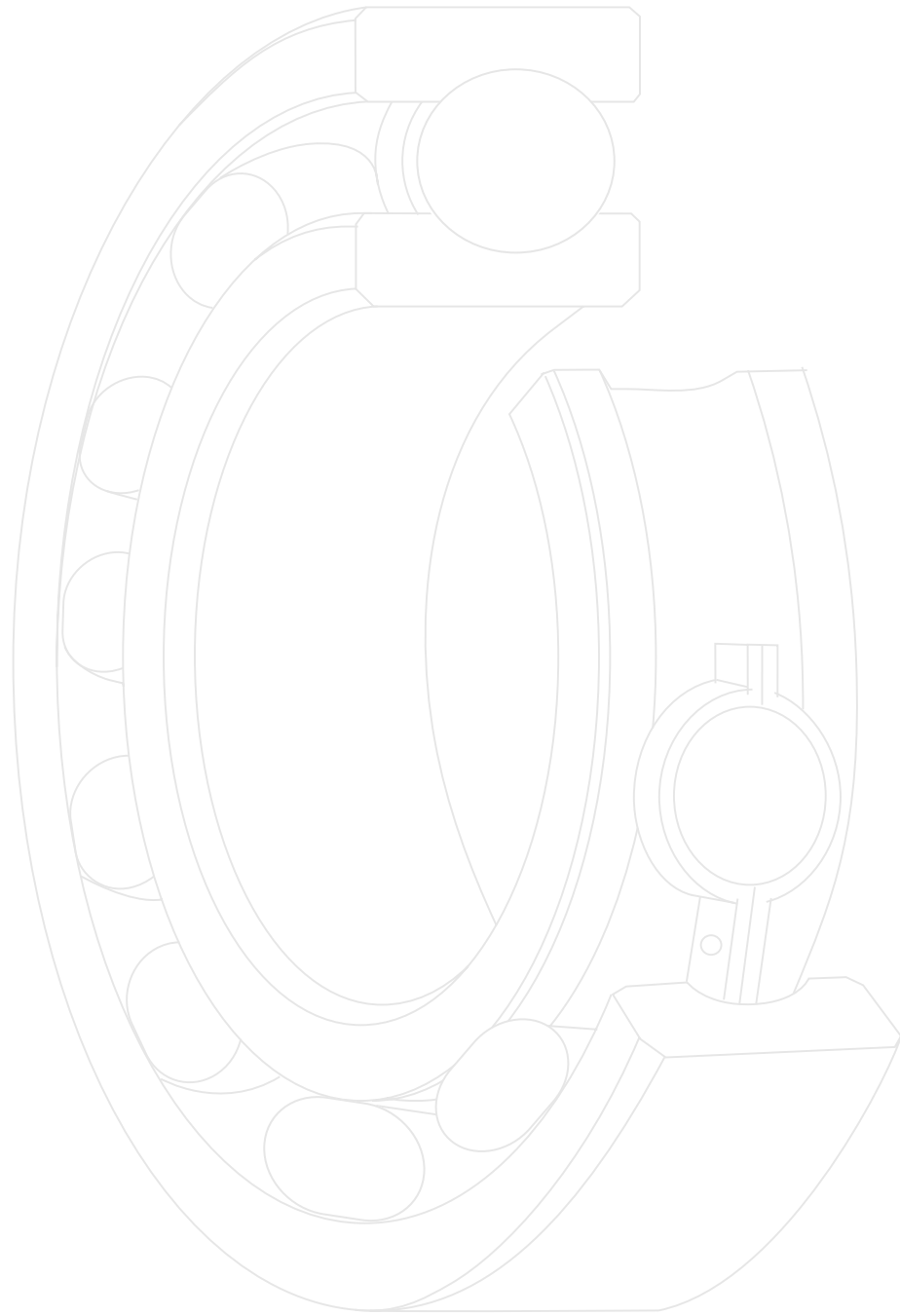

Introduction



KG International

MOVING TO
THE NEXT
50 YEARS
1968-2018



MOVING THE WORLD

50 years ago, a dream led to what is today a movement; a movement called KG International that is going strong-based on the beliefs, principals and ethics of the founding Chairman Mr. Kedar Gupta who founded the business in India way back in 1968.

The tiny acorn that germinated from an idea, a potential foreseen, is today a mighty oak in the shape of KG International of Jebel Ali Free Zone, Dubai. Sprawling over 55 countries in 5 continents, with a team size of over 100; KGI believes in forging relationships that last.

It has taken passion, determination, steely resolve and belief to create this reality, to make KGI a company favoured the world over for its quality, reliability, customer centricity and range on offer.

Kedar Gupta
Founder and Chairman
KGI Group

Rohit Gupta
CEO
KGI Group

A global family growing stronger

We choose to be a relationship-focussed company and prefer to work on a long-term basis with all our associates. By adding value through our knowledge-based expertise, we generate synergy through near partner-like associations, not only with our customers, but also with our external providers.

We have set examples for others to follow; be it exploring new markets or developing innovative strategies to service our customer's requirements. For us, customer service goes beyond the mere development of required products; we provide reliable solutions.

Our belief in our values is further reinforced by the trust gained over the years, from our associates spread worldwide. However, our greatest reward is our expanding global network of happy customers and external providers. While we seek new associations, strengthening existing relationships is our priority.



Our guiding principle is 'movement'

We provide cost-effective and customized solutions to help you with everything from standard bearings, special bearings to complete power transmission solutions, all under one roof. With a footprint in five continents and presence in 50+ countries, we are strategically located in Jebel Ali Free Zone, Dubai to offer world-class logistics support to our global customers.

KGI operates in 55 countries across 5 continents. We provide timely and efficient service everywhere you are. We are one of the pioneers in making Dubai an engineering component hub.



We lead the market because we serve

For almost five decades now, our motivation has been our desire to continuously outperform and exceed expectations. Our goals have always been high, our ambitions challenging and ethics demanding, as our focus continues to be our customers. From technical support and guidance, to on-time deliveries, all our systems are aligned to meet our customer's specific requirements.

Our Quality Management System has adhered to ISO Standards since 1999 and is currently following the ISO 9001:2015 version accredited by Lloyd's Register Quality Assurance (LRQA).

Our commitment to perfection has yielded exceptional results. Today, we are amongst the world's leading bearing companies, and this does not happen overnight. It has to be strived for and earned the harder way. The secret to success is our straightforward policy, which we never deviate from, i.e. service without compromise.



A movement gathering momentum

We believe that global competitiveness is the result of investments in modern technology, infrastructure, people, and systems. To ensure seamless workflow and management of our business processes, we have automated, integrated and centralized independent activities into a single operation.

Our in-house R&D and quality control procedures ensure that KG bearings are produced strictly in accordance with international standards. Regular on-the-job training and skill enhancement programs ensure that the KGI team is always up-to-date with the latest in technology and business practices.



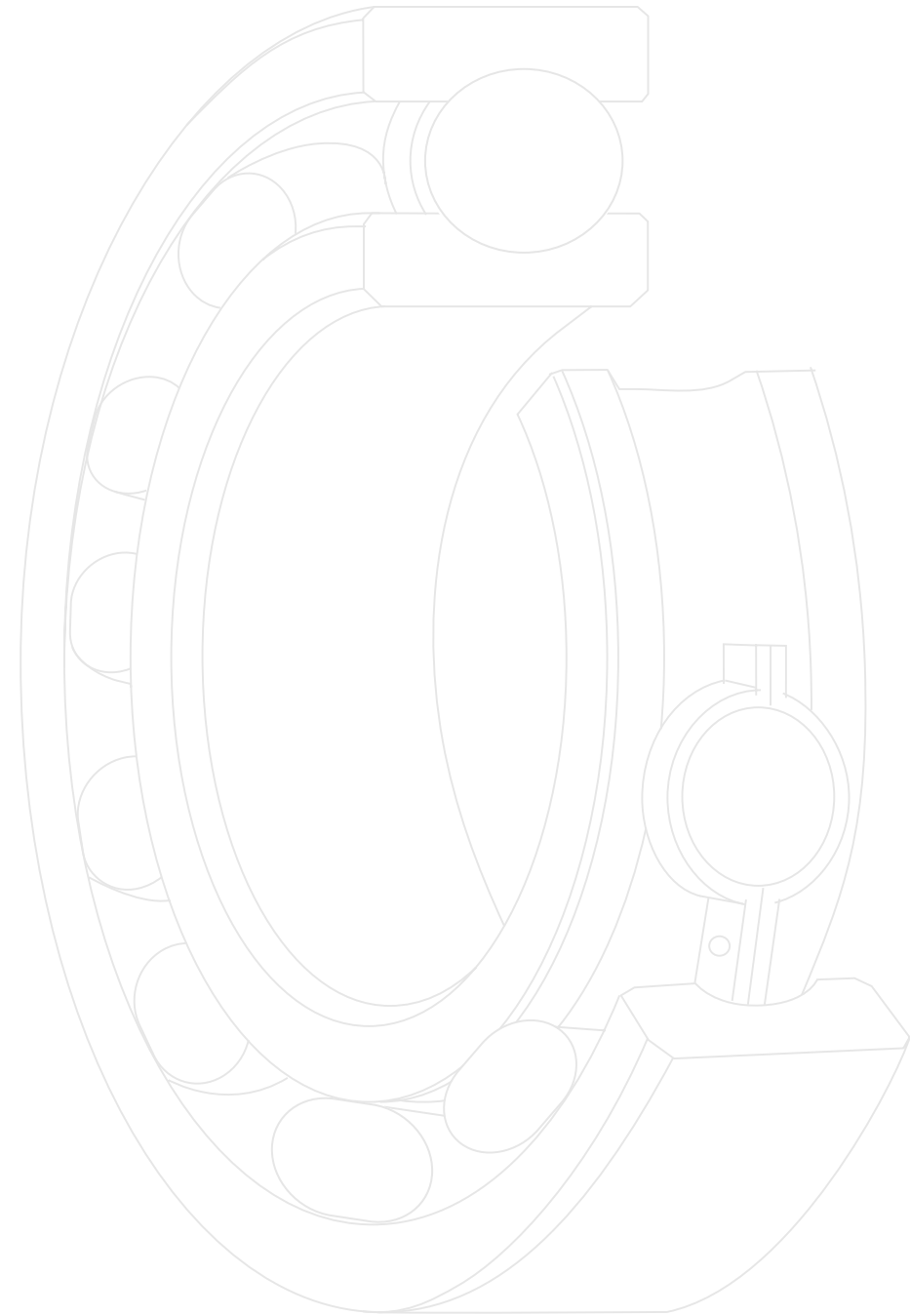

Bearings Introduction

The History of Bearings

The idea of using a rolling element to move heavy items dates back to 1900 BC. This was done by the ancient Egyptians, who used logs to roll large stone blocks closer to pyramid construction sites.

The earliest bearings were manufactured using lignum vitae, a very heavy, hard and natural oily wood, native to Central America and the West Indies. This wood's natural oil assisted the manufacturing process by acting as a cutting fluid. These bearings found use in "wet" applications such as propeller-driven vessels, water-wheels, and pumps, etc. Lubrication was done using tallow or other animal fats.

The Industrial Revolution of the 18th century brought about widespread usage of iron in industrial processes. It also introduced the steam engine as a practical source of power, and created a demand for new types of machinery, which in turn required specialized bearings. These were the reasons that forced the industry then, to look for alternative materials to produce bearings that could match performance requirements.

In the latter half of the 19th century, Henry Bessemer developed a new steel-making process, which was more economical. As a result, this period saw a greater reliance on steel as a raw material for the production of better quality bearings.

The 20th century has been witness to a bearings revolution, which was brought about by modern-day inventions, such as motorcars, domestic appliances, agricultural and industrial machinery, robotics and computers, etc. The bearing industry has kept pace by adapting to the new technology and materials, to produce more precise, durable, and specialized bearings.

Classification and Types of Rolling Bearings

Rolling Contact Bearings can be categorized in many ways. One is based on the end use of the bearing e.g., agricultural, automotive, industrial, etc. However, considering technical parameters and construction, there are two ways to classify Rolling Contact Bearings:

On the basis of their design for specific load management

- **Radial bearings**

Designed for mainly radial load applications, i.e. when load direction is perpendicular to the shaft axis.

- **Axial (Thrust) Bearings**

Capable of supporting mainly axial (thrust) loads, i.e. when load direction is parallel to the shaft axis..

On the basis of the type of rolling elements

- **Ball Bearings**

Undoubtedly the most common type of bearings, they find usage in numerous applications that may range from in-line skates to computer hard drives. Since these bearings can handle both radial and axial (thrust) loads, they find maximum usage in applications that involve relatively small loads.



Ball Bearings are classified into Deep Groove, Angular Contact or Thrust Bearings. They can be further categorized on the basis of the number of rows, i.e. single row or double row. Specifically, for Thrust Ball Bearings, specific classification is done on the basis of directional usage, i.e. single direction or double direction.

At times, Ball Bearings are also categorized on the basis of the relationship between the bearing rings and rolling elements, the shape

of bearing rings, or on the basis of used accessories.

- **Roller Bearings**

These bearings are more suitable for applications involving relatively higher loads, and can handle both types of loads, i.e. radial and thrust.

Roller Bearings can be classified according to the shape of rollers used, as Spherical Roller, Tapered Roller, Cylindrical Roller or Needle Roller Bearings.

Bearing's Classification on the basis of the shape of the Rolling Elements

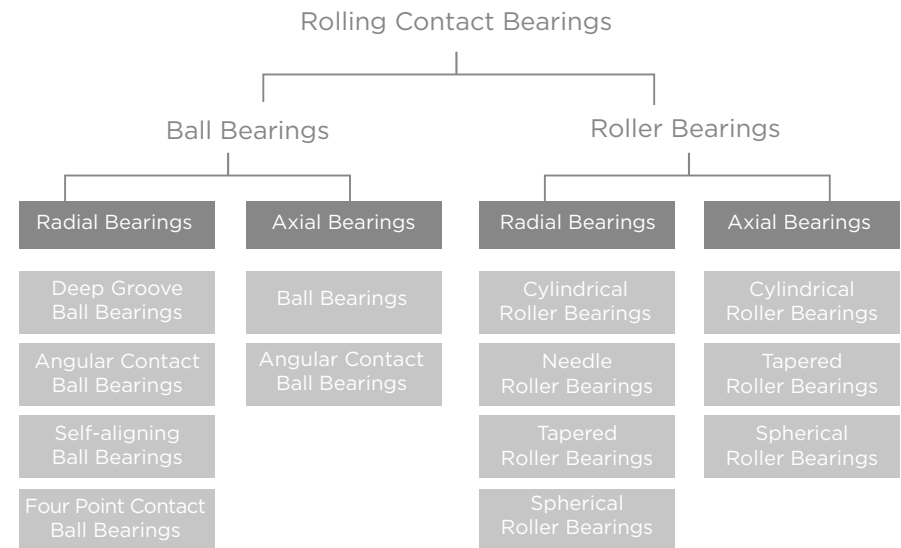

Design and Features of Rolling Contact Bearings

Generally, Rolling Contact Bearings comprise of an inner ring, an outer ring, rolling elements (balls or rollers) and a rolling element retainer (cage). It is the rolling elements and rings that bear the applied load (at the contact points of rolling elements and raceways); the cage does not bear any direct load. Its function is to hold the rolling elements at an equal distance from each other and prevent their fall out.

To achieve optimal performance from any bearing, it is important to properly define and understand the application requirements very judiciously.

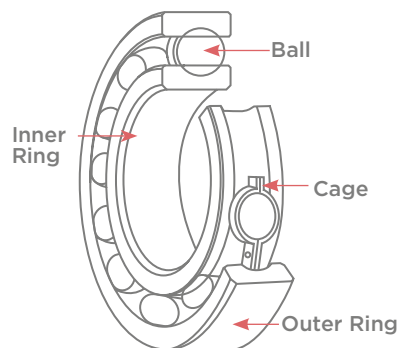

BALL BEARING

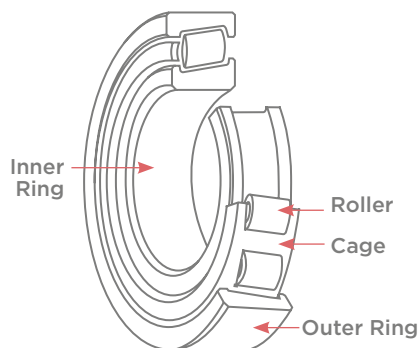

ROLLER BEARING

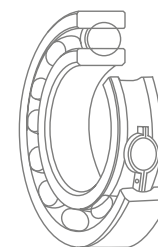

Deep Groove Ball Bearings

Deep Groove Ball Bearings offer multiple options that serve a wide range of applications.

They typically consist of an inner ring, outer ring, balls and cage. variants are available with steel shields, rubber seals (contact/non-contact type), snap-ring grooves with snap-rings, and a variety of cage types.

Deep Groove Ball Bearings are mainly of two types

- Single Row
- Double Row

These bearings are designed for radial, axial, and also composite load applications.

Deep Groove Ball Bearings offer

- uni or bi-directional load carrying capability
- very high speed rotation
- very good running accuracy
- low noise and low friction torque

Deep Groove Ball Bearings are also classified as

- Miniature Ball Bearings

Bearings with an outside diameter lesser than 9 mm.

- Extra Small bearings

Bearings with an outer diameter greater than or equal to 9 mm, and with bore diameter lesser than 10 mm.



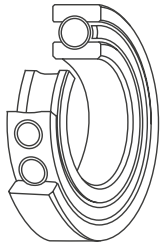

Angular Contact Ball Bearings

The raceway of both inner and outer rings of Angular Contact Ball Bearings are designed to maintain a specific contact angle between the balls and raceways, in the radial plane.

Standard cage materials for this type are pressed steel, high strength brass or synthetic resin. In comparison to a Deep Groove Ball Bearing, an Angular Contact type generally carries a higher number of rolling elements (balls), and is capable of sustaining radial, axial or composite loads.



Angular Contact Ball Bearings are classified into three sub-categories

- **Single Row**
They have three different contact angle classifications

Contact Angle Symbol	Contact Angle
A	30°
B	40°
C	15°

- **Double Row**
They have two different contact angle classifications

Contact Angle Symbol	Contact Angle
None	20°
A	30°

- **Combination Type**
Generally, Single Row Angular Contact Ball Bearings are used in combination of two or more units. Three different combinations are available.

Contact Angle Symbol	Contact Angle
Back - to - Back	Bidirectional axial
Face - to - Face	Bidirectional axial
Tandem	Unidirectional axial

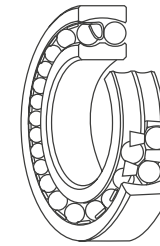

Self-Aligning Ball Bearings

Self-Aligning Ball Bearings are designed to contain the inner ring and ball assembly in the outer ring with a spherical raceway. Due to their special construction, these bearings can tolerate small angular misalignments of shaft upto 2.5° - 3° depending upon the bearing series. This misalignment could either be due to usage, or it could be due to a mounting error.

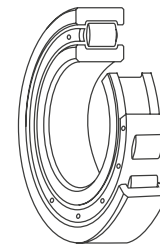

Cylindrical Roller Bearings



Cylindrical Roller Bearings probably have the most simple construction in the roller bearing category. These bearings are suitable for carrying relatively higher loads, at high-speed applications.

There is a linear contact between the rolling elements and bearing rings. This comparatively larger contact surface area enables Cylindrical Roller Bearings to handle a much greater radial load, compared to a Ball Bearing. However, their axial load bearing capacity is limited. Numerous variants of this bearing type are available to match specific application requirements, for e.g. NU, NJ, N, NF, NUP, NN, etc.

Compared to the single row type, Double Row Cylindrical Roller Bearings are used for higher speed and greater accuracy applications, e.g. in machining centres, etc.

Cylindrical Roller Bearings are generally used along with Plummer Blocks, and are available with two bore types, i.e. cylindrical and taper. Their cages are made of either pressed steel or polyamide resin.

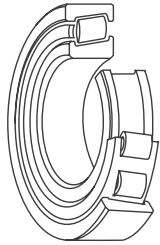

Tapered Roller Bearings

As the name implies, the rolling elements and raceways (of the outer and inner rings) of these bearing are made with a tapered profile. These bearings can be separated into components, i.e. the outer ring (cup), and the combined inner ring and roller assembly (cone).

Tapered Roller Bearings are further classified into

- **Single Row**
A Single Row Tapered Roller Bearing can support a combined radial and axial load. However, if an application has a bi-directional

axial load, then two Single Row Tapered Roller Bearings can be used together in a back-to-back or face-to-face mounting pattern.

- **Double Row**
Double Row Tapered Roller Bearings are specially made to sustain radial and bi-directional axial loads.
- **Four Row**
Four Row Tapered Roller Bearings can support much heavier radial and impact loads, in addition to the standard capabilities of Double Row Tapered Roller Bearings.

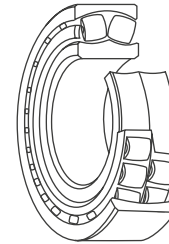

Spherical Roller Bearings

In Spherical Roller Bearings, the raceway of the outer ring is designed to have a spherical profile, whose centre coincides with the bearing's centre point.

This type of bearing is a self-aligning type. Hence, can be used for applications where a misalignment of shaft may arise either due to an erroneous mounting or due to shaft

deflections. The outer ring generally has lubrication holes and grooves. These bearings are suitable for very high radial load applications, and a moderately high level of bi-directional axial load.

Spherical Roller Bearings have two bore types

- Cylindrical Bore
- Tapered Bore



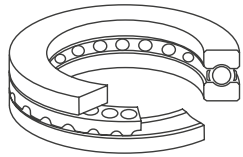

Axial (Thrust) Ball Bearings

Thrust Ball Bearings are designed to handle axial loads only. They should not be used for any radial load applications.

A bearing ring mounted on a shaft is called Shaft Washer, and the one mounted on a housing is called Housing Washer.

Thrust Ball Bearings are of two types

- **Single Direction type**
Suitable for handling only uni-directional axial loads.

- **Double Direction type**
Suitable for handling bi-directional axial loads.

Thrust Ball Bearings are not suitable for high-speed applications. At high-speeds, a sliding movement between balls and raceways can occur, which may result in smearing. Further at high-speeds, centrifugal forces expel lubricating oil. This fact alone restricts the acceptability of Thrust Ball Bearings for high-speed applications.

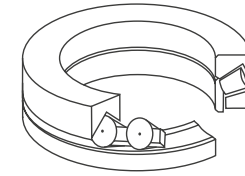

Thrust Roller Bearings

Thrust Roller Bearings are preferred for axial load applications, as they provide higher rigidity in comparison to other types.

Thrust Roller Bearings are of three types

- Thrust Cylindrical Roller Bearings
- Thrust Tapered Roller Bearings
- Thrust Spherical Roller Bearings

A Thrust Spherical Roller Bearing is a self-aligning bearing. In service, it allows a maximum shaft misalignment

of about 2°. The contact angle helps this type of bearing to handle a small amount of radial load.

Lubrication of these bearings needs to be done carefully, since large sliding contact areas results in smearing. Care should be taken to maintain the least rated minimum load on this bearing, to avoid smearing.

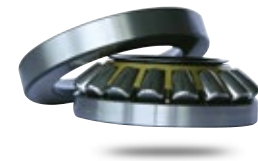

Types, Construction and Features of Rolling Contact Bearings

CHARACTERISTICS			BEARING TYPES	Load Carrying Capacity	High Speed Suitability	Rigidity	Misalignment Permissibility	Quiet Operation
Deep Groove Ball Bearings								
Type	Cross Sections	Bearing Series						
Without Filling Slot		67-68-69-60-62 63-64-RLS-RMS-16000						
Without Filling Slot (for Bearing Units)		UC-UE-UK-AEL-SB						
With Filling Slot		42-43						
Angular Contact Ball Bearings								
Type	Cross Sections	Bearing Series						
Non-Separable		79-70-72-73-74 ALS-AMS						
Without Filling Slot		52-53						
With Filling Slot		32-33						
Self-aligning Ball Bearings								
Type	Cross Sections	Bearing Series						
Double Row		12-13-22-23						
Four Point Contact Ball Bearings								
Type	Cross Sections	Bearing Series						
Single Row		QJ2-QJ3						
Thrust Ball Bearings								
Type	Cross Sections	Bearing Series						
Single Direction Flat Back Face		511-512-513-514						
Single Direction Spherical Back Face		532-533-534						
Double Direction Flat Back Face		522-523-524						
Double Direction Spherical Back Face		542-543-544						

CHARACTERISTICS			BEARING TYPES	Load Carrying Capacity	High Speed Suitability	Rigidity	Misalignment Permissibility	Quiet Operation
Thrust Angular Contact Ball Bearings								
Type	Cross Sections	Bearing Series						
Single Direction								
Double Direction								
Cylindrical Roller Bearings								
Type	Cross Sections	Bearing Series						
Inner Ring without Rib on one side		NJ2-NJ22-NJ3-NJ23-NJ4						
Inner Ring with loose Rib on one side		NH2-NH22-NH3 NH23-NH4						
Inner Ring without Rib on both sides		NU10-NU2-NU22 NU3-NU23-NU4						
Outer Ring without loose Rib on one side		NF2-NF3-NF4						
Outer Ring without Rib on both sides		N10-N2-N3-N4						
Inner Ring without Ribs on both sides (2 rows of Rollers)		NNU49						
Outer Ring without Ribs on both sides (2 rows of Rollers)		NN30						
Needle Roller Bearings								
Type	Cross Sections	Bearing Series						
Inner Ring without Rib		NA48-NA49						
Without Inner Ring		RNA48-RNA49						

LEGENDS

- Single Direction Axial Load
- Double Direction Axial Load
- Thin Arrow Denotes Lower Capacity
- Thick Arrow Denotes Higher Capacity
- Radial Load
- Very Good
- Normal
- Good
- Not Suitable
- Limited

CHARACTERISTICS			BEARING TYPES	Load Carrying Capacity	High Speed Suitability	Rigidity	Misalignment Permissibility	Quiet Operation
Tapered Roller Bearings								
Type	Cross Sections	Bearing Series						
Single Row		320-302-322-303-303D 323-329-330-331-332	↕					
Double Row (Inward type)		DRT	↕↔	●	●	●	●	●
Double Row (Outward type)		DRT0						
Four Row Roller (Separable)		FRTR						
Spherical Bearings								
Type	Cross Sections	Bearing Series						
Double Row Roller		239-230-240-231-241 222-232-231-223	↕	●	●	●	●	●
Plain		GE	↕					
Roller Thrust		292-293-294	↕					
Thrust Cylindrical Bearings								
Type	Cross Sections	Bearing Series						
Roller (Flat Back)			←	●	●	○	●	
Thrust Tapered Bearings								
Type	Cross Sections	Bearing Series						
Roller (Flat Back)			←	●	●	○	●	

LEGENDS							
→	Single Direction Axial Load	↑	Radial Load	●	Normal	●	Limited
↔	Double Direction Axial Load	↕	Thick Arrow Denotes Higher Capacity	●	Very Good	●	Good
↑	Thin Arrow Denotes Lower Capacity	○		○	Not Suitable		



Selection of Rolling Contact Bearings

to study both the bearing and its application parameters. Generally, since a shaft diameter is known beforehand, the focus should be on application parameters. The flowchart on the following page shows a sample selection procedure.

Major bearing selection parameters are

- load types (i.e. radial, axial, or moment)
- the magnitude of these loads on the bearing
- limiting speed
- noise and torque levels
- rigidity and chances of misalignment
- bearing life
- accuracy

The performance and service life of any machine or equipment is directly related to the performance of the bearings used in it. There is no standard rule of bearing selection for different applications. To avoid unnecessary costs and loss of machine time, a systematic effort must be made to consider maximum parameters for selecting the most suitable bearing for an application.

With diversification in bearing designs, their application range has also expanded. With multiple choices available, to make the best selection, it becomes mandatory



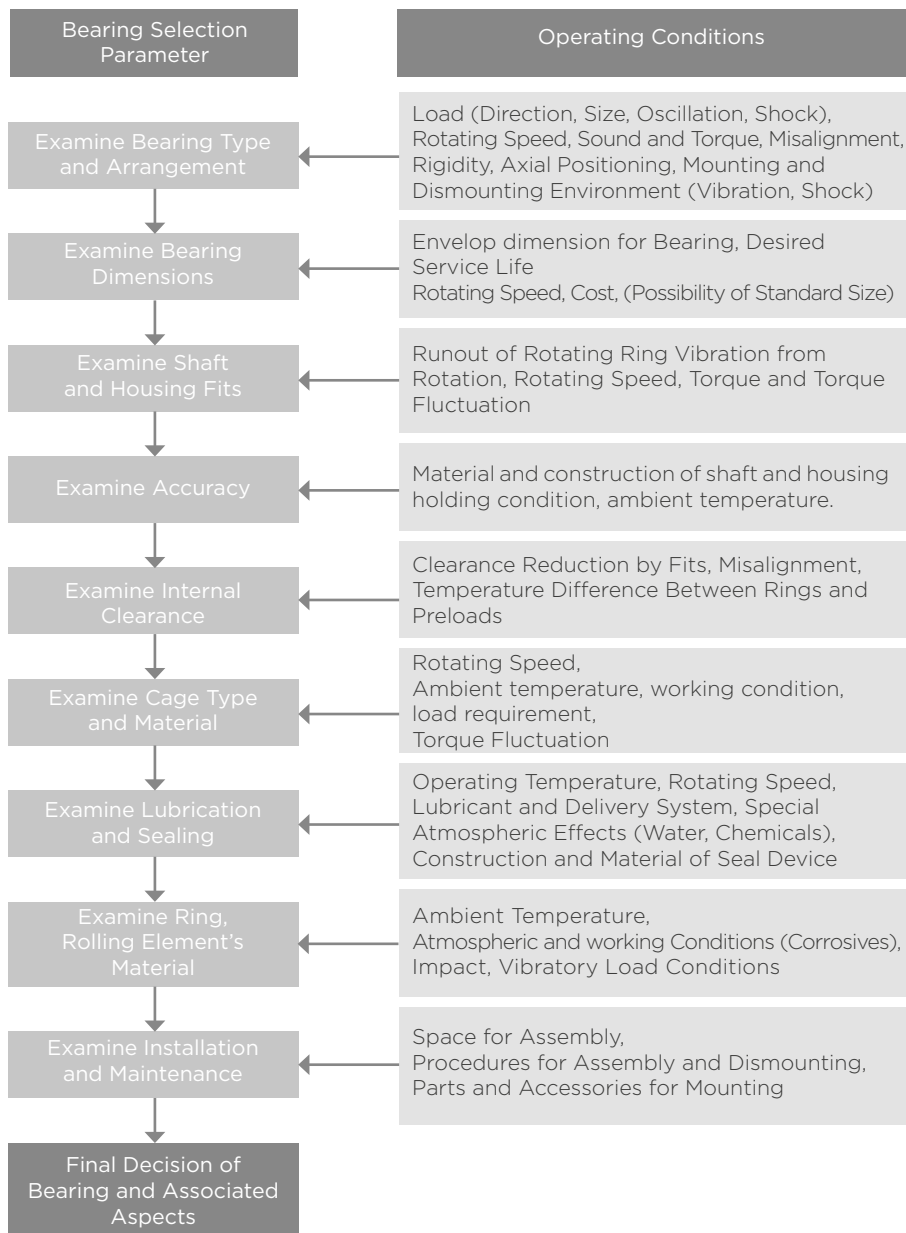

Material for Rolling Contact Bearings

Under operative conditions, rolling elements roll and slide between a bearing's outer and inner rings, subjecting the contact areas to high and repetitive stress, leading to material fatigue after some usage. This fatigue can lead to an eventual bearing failure.

Material for Rings and Rolling Elements

The choice of material to be used in bearing rings and rolling elements depends on the typical design and application requirements.

Basic and desirable material characteristics

- higher hardness
- good wear resistance

- higher rolling contact fatigue resistance
- dimensional stability
- good mechanical strength

Bearing performance is greatly influenced by the material used in its construction. Generally, material for a bearing rings and its rolling elements is selected according to the application conditions. To meet higher hardness requirements, high carbon chrome bearing steel is mainly used. For a corrosive atmosphere, stainless steel is preferred. If good tolerance to high temperature is required, then high-speed steel is preferred. Similarly, Ceramic Bearings are used for certain special applications.

Chemical Composition for Various Types of Bearing Steels

The material for KG Rolling Bearings is normally high carbon, through-hardened chromium steel with a good degree of cleanliness. For special applications that involve shock loads and reverse bending stresses, certain bearings made with case-hardened steel are also available.

*High Carbon Chrome Bearing Steel - SAE 52100/100Cr6/SUJ2/GCr15

Chemical Composition (%)						
C	Si	Mn	P	S	Cr	Mo
0.90-1.10	0.15-0.35	≤ 0.25-0.45	≤ 0.027	≤ 0.025	1.30-1.60	≤ 0.10

*Case Hardening Steel

Standard	Symbol	Chemical Composition (%)							
		C	Si	Mn	P	S	Ni	Cr	Mo
SAE	8620	0.18-0.23	0.15-0.35	0.70-0.90	≤ 0.035	≤ 0.040	0.40-0.70	0.40-0.60	0.15-0.25
	4320	0.17-0.22	0.15-0.35	0.45-0.65	≤ 0.035	≤ 0.040	1.65-2.00	0.40-0.60	0.20-0.30

*Stainless Steel

Symbol	Chemical Composition (%)						
	C	Si	Mn	P	S	Cr	Mo
SUS440C	0.95-1.20	≤ 1.0	≤ 1.00	≤ 0.040	≤ 0.030	16-18	≤ 0.75
SUS420C	0.15-0.36	≤ 1.0	≤ 1.0	≤ 0.04	≤ 0.030	12-14	-

* These shown values are only for reference.

Material for Cages

Similar to the desirable characteristics of the material for rolling elements, the material used in the fabrication of bearing cages should also possess certain desirable properties.

Desirable cage properties

- good wear resistance
- dimensional stability
- good mechanical strength

There are three standard types of cages

- Pressed cages, that use cold-rolled steel

- Machined cages, that use high tensile strength brass castings or carbon steels

- Polyamide cages, that use polyamide resins

Once again, the choice of material for bearing cages is made according to the operating conditions. For instance, brass cages should not be used in environments with ammonia, or at temperatures above 300° C, as this may cause season cracking. Similarly, polyamide cages should only be used in the temperature range of -40° to +120° C. They should not be used in a vacuum, as the resin may become brittle due to dehydration.

Lubrication

of lubricants, which can vary with the type of application.

When in use, friction due to moving parts may generate heat, which reduces lubricant viscosity, which further deteriorates lubricant quality and its subsequent evaporation.

Selection of both, i.e. proper lubricant and the correct lubrication method is critical to a bearing's performance and operational life. Generally, rolling bearings use either an oil-based or a grease-based lubricant. Some applications may call for more specialized lubricants such as graphite, PTFE or molybdenum disulfide-based varieties.



Bearing rings, rolling elements and cage are subjected to high levels of rolling and sliding friction. This friction may damage the bearing, and eventually reduce its service life. Proper lubrication can reduce frictional damages and extend a bearing's productive life.

Lubricants separate rolling and sliding surfaces with a very thin film of oil. The applied load is carried by pressure generated within the fluid; frictional resistance to motion arises entirely from the shearing of the viscous lubricating fluid. A bearing's performance and service life largely depend on the appropriate selection

Essentially, lubricants have following roles to play

- reduce rolling friction between rolling elements and raceways.
- minimize sliding friction between
 - the rolling end and guide faces of bearing
 - the rolling elements and cage
 - the cage and raceway guiding surfaces
- prevent foreign particle contamination
- prevent rust and corrosion
- remove heat from bearing

- uniformly distribute stress to the rolling contact surfaces
- provide some relief from impact loads

Desirable characteristics of a good bearing lubricant are

- nil moisture content
- non-reactive properties with bearing materials
- nil impurities
- good temperature stability
- non-corrosivity
- good wear and friction resistance
- high mechanical stability
- load pressure resistance

Guide to Selecting Oil and Grease Lubricants

Application Conditions	Grease	Oil
Temperature	Not suitable for high temperature (100°C to 120°C)	Suitable for high temperature (with circulating cooling)
Speed	Low to medium speeds	Suitable for high speeds (depends on lubrication method)
Load	Light to medium loads	Suitable for high loads
Housing design maintenance	Simple	Complicated (need to consider oil leak prevention)
Centralized lubrication	Possible	Easy
Dust filtration	Not possible	Possible (circulating lubrication provides a filter to trap dust)
Rolling resistance	Large	Small (correct oil quantity must be maintained)

Lubricating Oil

Since it is only a thin oil film that separates the contacting surfaces, it is important for this film to have correct viscosity. Emphasis is on correct viscosity, as both lower or higher viscosity of a lubricating medium at operating temperatures can affect bearing performance.

Low viscosity can cause the lubricating film to break, leading to a lubrication failure. At the same time, higher viscosity increases the operational torque, which results in power loss and an abnormal rise in temperature.

Viscosity in itself changes with temperature. Higher the temperature, lower will be the viscosity. This relationship between viscosity and temperature is an important criterion for selection of lubricating oil for a particular application.

For correct lube oil selection, apart from viscosity, solidification temperature and flash point (temperature) are also important considerations. This information is critical for determining and maintaining the correct operating temperature, for the selected lubricating oil.

In order to maintain optimum lubrication and good service performance of bearings, lubricating oil samples must be tested at regular intervals. Lubricating oil should be changed, if any alteration in colour or viscosity is noticed, or the presence of impurities is observed.

Bearing Types and Proper Viscosity of Lubricating Oils

Bearing Type	Viscosity at Operating Temperature
Ball Bearings, Cylindrical Roller Bearings	Over 13 mm ² /s
Tapered Roller Bearings, Spherical Roller Bearings	Over 20 mm ² /s
Spherical Roller Thrust Bearings	Over 32 mm ² /s

Lubricating Grease

Grease is generally the preferred lubricant for rolling bearings. The reason is simple; no special sealing devices are required to prevent drain off at standstill, or even otherwise. But grease increases bearing wear, due to its tendency to accumulate abrasive particles that maybe generated during normal bearing usage.

Grease is made using three components

- base oil
- thickener
- additives

The actual lubricant is the base oil, thickener gives it consistency and additives impart performance enhancing characteristics. All three are important for every bearing application.

Usually, mineral oils are used as base oils for grease. For improved heat resistance and stability, synthetic oils, like silicone and diester are used. Generally, grease with low viscosity

base oil is good for low loads and low temperature applications, whereas for high temperature and heavy load applications, grease with high viscosity base oil is preferred.

Thickeners are added to base oils for imparting consistency to the blend, and together they account for 80%-90% of grease content. Essentially, it is a sponge like structure, with a weak bonding of fine fibres or particles.

Additives are added to impart performance enhancing properties to grease. Extreme pressure additives may improve load and impact resistance, while anti-oxidant additives protect grease from oxidation and thermal deterioration. Likewise, rust prevention additives enhance rust resistance capabilities.

The amount of grease to be used for lubrication varies with the bearing size; other parameters like operating speed and temperature, type and amount of load, ambient conditions, etc. are also important considerations. Generally, a minimum level of 30%, and on the upper side up to 50% of a bearing's internal volume (free space) should be filled with grease. If lithium-based greases are being used, then up to 90% of available space can be filled up.

Typical Lubricating Greases for Bearings

Name of Grease	Grease maker	Base Oil	Thickener	Penetration
Daphne Eponech No. 2	Idemitsu Kosan	Hydrodesulfurized wax	Lithium	280
Beacon 325	Exxon Mobil	Diester Oil	Lithium	280
Polyrex EM	Exxon Mobil	Mineral Oil	Polyurea	285
Mobilgrease 28	Exxon Mobil	Diester Oil+Mineral+Oil +Synthetic Hydrocarbon	Microgel	270
Mobilux 2a	Exxon Mobil	Mineral Oil	Lithium	270
Temprex N3	Exxon Mobil	Mineral Oil	Lithium Complex	235
Barrierta IMI	NOK Kluber	Flourine	PTFE	280
Isoflex NBU15	NOK Kluber	Diester+Mineral Oil	Barium Complex	280
Isoflex NCA15	NOK Kluber	Synthetic Ester Mineral Blend	Calcium Complex	280
Isoflex LDS18SA	NOK Kluber	Ester Oil	Lithium	280
NOXLUB BN2420P	NOK Kluber	PFPE Oil	Special Thickener	280
NOXLUB BN4020	NOK Kluber	PFPE Oil	Special Thickener	280
Stabrag NBU 8 EP	NOK Kluber	Mineral Oil	Barium Complex	280
Multemp LRL3	Kyodo Yushi	Polyolester	Lithium	235
Multemp PS2	Kyodo Yushi	Diester Oil+Mineral Oil	Lithium	275
Multemp SRL	Kyodo Yushi	Tetraester	Lithium	245
Alvania Grease 2S	Shell	Mineral Oil	Lithium	276
Alvania Grease 3S	Shell	Mineral Oil	Lithium	240
AeroShell Grease 7	Shell	Mineral Oil	Microgel	285
Alvania EP Grease 2	Shell	Mineral Oil	Lithium	285
Darina 2	Shell	Mineral Oil	Microgel	285
Retinax LX No. 2	Shell	Mineral Oil	Lithium Complex	270
SH44M (DC44M)	Dow Corning Toray	Silicone Oil	Lithium	260
NIGACE WR-S	Nippon Grease	Synthetic Oil	Urea	240
Hangu		Mineral Oil	Lithium	280

Remarks

- When grease is to be used near the high or low end of the recommended operating temperature, please contact KG International FZCO
- Please be careful, when you use grease with Ester Oil base, as it may damage

Dropping Point (°C)	Operating Temp. Range (°C)	Color	Properties				
			Water Resistance	High Speed Rotation	Noise	Grease Life at High Temp.	Torque at Low Temp.
197	-40-130	Tan	●	●			
193	-54-120	Light Grey	●	●			●
300	-20-180	Blue	●				
270	-62-177	Red	●				
178	0-125	Brown	●				
300	-30-150	Green	●	●			
None	-50-220	White	●	●			●
250	-40-130	Beige	●	●			
180	-50-120	Beige	●	●			
190	-60-130	Yellow	●	●			●
None	-35-220	White					
220	-35-150	Beige					●
208	-50-150	Peach White	●		●	●	●
190	-55.-130	White	●	●			
191	-40-150	Light Yellow	●		●	●	●
185	-25-120	Tan	●		●		
185	-20-135	Tan	●		●	●	
268	-73-150	Light Brown	●	●		●	●
185	-15-110	Reddish Brown	●				
260	-25-150	Light Yellowish Brown	●			●	
250	-15-150	Light Brown	●			●	●
210	-40-180	Brown	●			●	●
290	-30-150	Light Yellow	●			●	
196	-20-120	Light Yellow	●				

Polyacrylic Rubber or ABS Resin

- Do not mix different types of greases
- If Sodium thickener grease is mixed with water, it will soften and may leak

Handling of Bearings

Rolling Bearings are machined elements that work in a high precision environment; their correct handling is critical to obtain an optimal performance.

Recommendations for storage

- store at a cool and dry place, away from direct sunlight and moisture
- store at a raised base (around 30 cm) above the floor, to avoid dust accumulation
- maintain a stable temperature in the storage area (around 20° C)
- maintain humidity levels (below 65%) to prevent rusting
- do not stack bearings in many layers to avoid falling and consequential damage
- use bearings on a first-in and first-out basis, to use older packs first

- take maximum care to save bearings from impact shocks like dropping etc., as they can damage the raceways, rolling elements or the cage

Recommendations for transportation and handling

- protect a bearing from falling when transporting it
- handle heavy bearing cases with forklift or hoist
- always cover bearings with clean packing paper / polybag
- to avoid contamination, do not open the bearing pack until just prior to installation
- avoid direct human contact with a bearing, use proper tools and wear gloves to protect them from rust or contamination

Mounting of Bearings

Bearing performance not only depends on a careful selection of good quality bearing type, but also on its proper mounting.

Mounting Preparation

Before mounting, following precautions must be taken

- tools and equipment should be prepared, cleaned and checked for any cracks or breakage
- the place for mounting should be clean and dry
- unpack the bearing just before mounting
- clean and check both shaft and housing for presence of nicks, burrs or any signs of physical damage
- measurements of shaft and housing size, roundness taper, surface finish, shoulder squareness etc., should be recorded and verified for conformity with design specifications
- in case of split housing, extreme care should be taken to avoid misalignment and deformation that maybe caused by tightening or over-tightening of mounting bolts

- the lubricant and its applicators should be properly cleaned and closed
- the method of cleaning the bearing and its relevant parts should be established and understood

As rust preventive oil is also a good lubricant, it should not be cleaned off, when the bearing is to be used for normal applications. If the bearing is to be used in a measuring equipment or at a high-speed application, rust preventive oil should be removed using a clean detergent oil. In any case, a bearing should not be left in the open (especially after removing rust preventive oil) for a long time.

Bearing Mounting Methods

Generally, the following bearing mounting methods are used in the industry.

A. Press-fit Method

Depending on the application requirement, either the inner ring (Fig. 1) or the outer ring (Fig. 2) or both the rings (as shown in Fig. 3) are press-fit using a jack, a hydraulic press, or a mounting fixture that has an end which matches the size of the respective ring(s). A plastic hammer should be used to drive the bearing on the shaft to minimize shock to the bearing.

B. Thermal Expansion Method

In this method, the inner ring is heated using an induction heater or a heating tank. This process eliminates the need to apply undue stress on the bearing, as a heated bearing expands and it can easily slide on the shaft. The heating temperature should not exceed 120°C, as it may reduce the hardness of the bearing steel.

After mounting, the remaining procedure should be completed smoothly and quickly. Further, the bearing should not be allowed to develop any residual misalignment, as it is hard to correct once it cools down. Similarly, a clearance may develop between the inner ring and shaft. To avoid this problem, the clamping nut should be re-tightened while the bearing is still hot, but cooling down.

The Thermal Expansion Method is generally used to mount bearings with a large bore size.

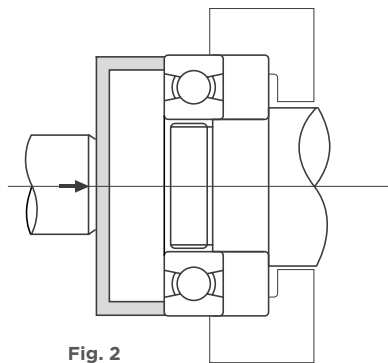

C. Adapter or Withdrawal Method

In this method, a tapered sleeve is inserted between a bearing's tapered bore and cylindrical shaft. Then using a locknut, the bearing is driven up the sleeve. This process is divided into several steps; the bearing's internal clearance, also known as residual clearance, should be measured each time. Before sliding the sleeve, the measured internal clearance is called initial clearance. The difference between the residual clearance and the initial clearance determines the amount of interference.

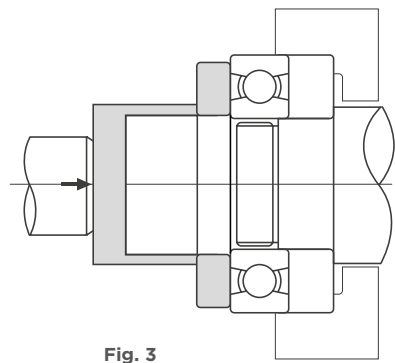
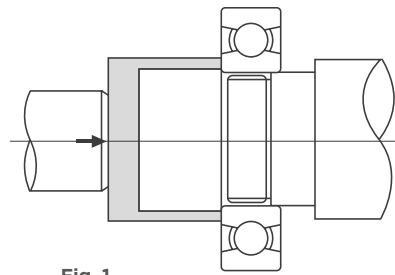

Dismounting of Bearing

Common Dismounting Tools

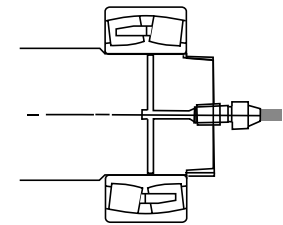

Dismounting Bearing with Oil Injector

The choice of method for bearing dismounting is largely dependent on the objective. For instance, if the bearing has to be disposed of, even a cutting torch can be used. However, if the bearing has to be re-used or a study has to be conducted on failure causes, it is pertinent to dismount it without any damage to the bearing or its parts, especially the raceways and rolling elements.

Before dismounting, the condition of the rotating parts, interference, and lubricants should be checked and recorded to find out the possible causes of failure and the corrective measures required to solve the problem.

Precautions to be taken before dismounting

- decide dismounting method in advance
- dismount under an expert's supervision
- check, prepare and keep ready required dismounting tools and equipment

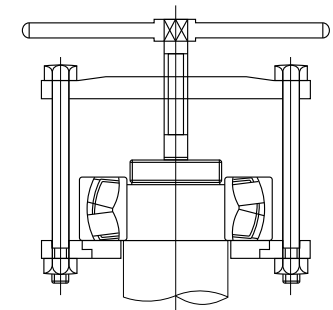

Dismounting Bearing with Special Puller

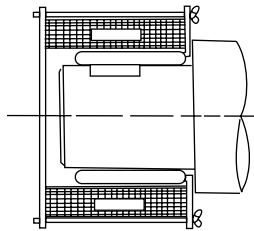

Inner Ring removal using Induction Heater

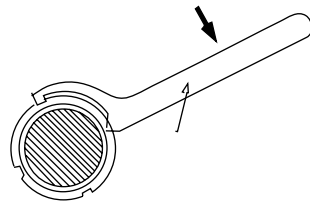

Dismounting Bearing with Spanner Wrench

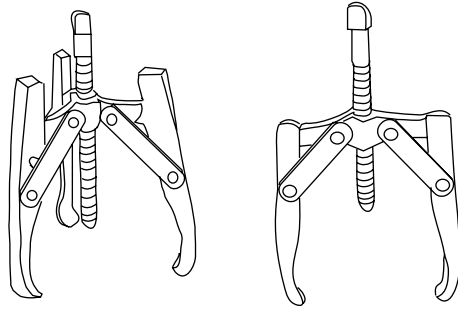

Bearing Pullers

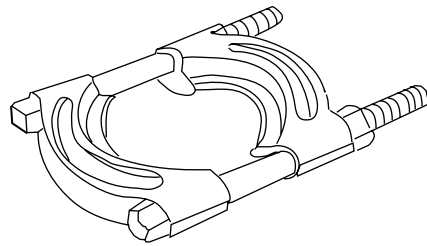

Puller Attachment

Bearing Failures

It is an established fact that bearings do not break down abruptly. A diligent observant approach to identify warning signs of an imminent failure, can prevent machinery breakdowns and consequential losses.

At KGI, we take due care to deliver bearings that allow long storage life. Once the bearings arrive at the consumer's warehouse, their proper storage is important. To a limited extent, the rust-preventive oil coat on the bearings can protect them from corrosion. However, high relative humidity levels, or even substantial day-night temperature variations can expose bearings to moisture.

Normal use of bearings is accompanied by

- minor vibrations
- operating noise
- a slight increase in temperature due to operations
- electricity consumption
- lubricant deterioration over time

A sudden increase in general level of any of these parameters is a definite indication of an impending bearing failure or seizure. Overlooking any of these faults can lead to serious problems. It could severely damage principal equipment or even lead to a fire.

Failures causes are classified into three categories

- **failures due to environmental factors**
negligence in mounting, dirty working conditions, inadequate lubrication, over-loading, vibrations, over-speeding, over-heating, pollution.
- **failures due to misapplication**
incorrect selection of the type of bearing, or improper mounting
- **failures due to the quality of the bearing itself**
 - material fault quality, structure or steel composition
 - design and production fault internal geometry, cage or seal quality

The following pages only outline the environmental factors that cause 90% of bearing failures. Failures due to misapplication and bearing quality seldom occur. Moreover, their investigation and analysis require elaborate means of research and quality control.

Environmental Causes and Origins of Bearing Failures

Bearing failures occur due to many external causes, but they can be classified into four basic categories

Mounting Conditions

- improper tools and mounting procedures
- dirty mounting conditions
- mounting shock loads
- improper manufacturing of components
- surrounding the bearing with out of tolerance shafts and housings, misalignment, etc.

Operating conditions

- over-loading
- external vibrations
- over speeding
- shaft deflection (bowing)

Environmental conditions

- too low or too high an ambient temperature
- electric arcing
- contamination from water, dust, chemicals, textile debris, etc.

Lubrication conditions

- improper lubricant
- inadequate supply of lubricant
- long re-lubrication interval

The chart on the following page should guide the user in identifying the probable cause of failures, and also assist in better failure management.

Diagnosis of Bearing's Abnormal Operating Conditions

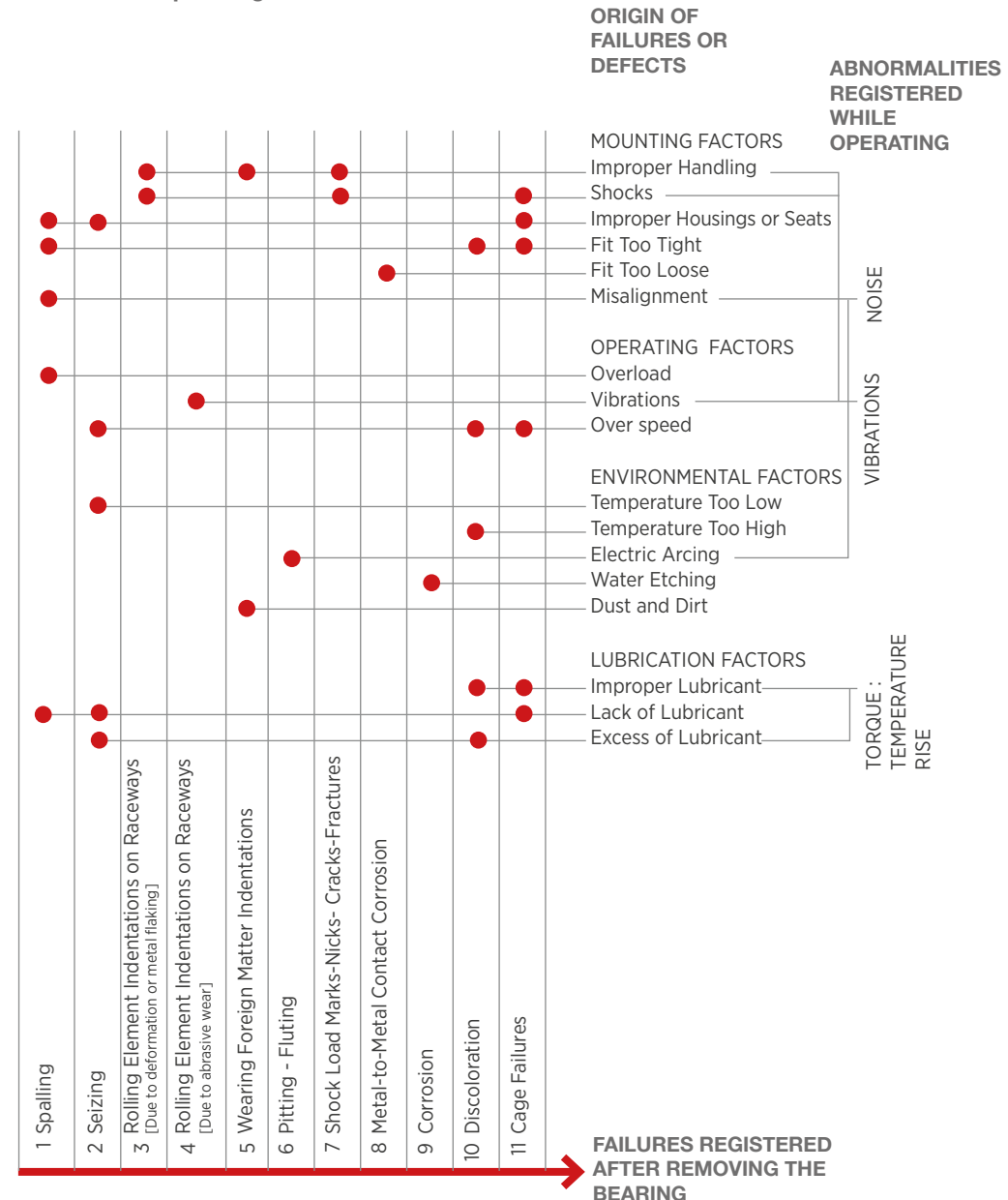

Detection of a Bearing's Failure

Bearing users' main concern should be to detect the beginning of a failure, prior to equipment breakdown. Preventive maintenance is essentially the best remedy, but in certain cases the amount of time taken and the high expenses involved in reaching the bearing can be the deterrents. Though, for some applications preventive maintenance is a "must" (e.g., the aircraft industry, mine ventilation, etc.). Even though, the amount of fatigue in a bearing is difficult to evaluate from external indications, however as a thumb rule, users should consider the approaching end to a bearing's useful life, once external indications become detectable.

External Indications of Damage

A bearing rotating under functional conditions will exhibit certain "normal parameters" such as operating temperature, noise and vibrations. Their exact levels are dependent on several factors: load, speed, lubrication, type of bearing, etc. Abnormally high levels of "normal parameters" should be considered as a warning of a probable failure.

Deviations from the "operating norms" established under "operating

conditions" for any of the following, should signal the need for preventive maintenance or at least a close examination to ascertain the cause.

- **Vibrations**

These can be detected by hand or with electronic equipment (frequency or amplitude analyser). An alert operator should stop the machine.

- **Noises**

Some abnormal noises can be heard immediately, such as those due to the rolling element's indentations because of improper mounting; others increase progressively. Noise indicates an incipient failure and varies in intensity and frequency with the extent of the damage. The damage due to unbalanced loads is generally inaudible since their frequency is identical to the rotating assembly's frequency.

- **Temperature rise**

All operating bearings are subjected to temperatures above the ambient, which vary according to the type of mounting. Any rise beyond the normal level is an indication of the beginning of failure.

- **Increase of rotational torque**

Even when mounted on bearings, all rotation systems produce a resistance torque. An increase in this torque, is accompanied by an eventual temperature rise, which indicates an alteration in the bearing's performance.

Interpretation of External Indications

Vibration

- Spalling
- abrasive wear due to foreign particles
- corrosion
- unbalanced loads due to bearing wear
- excessive clearance
- under-tightening of a ring

Noise

- indentations of rolling element
- Spalling
- False brinelling (indentations due to vibrations)
- foreign particles
- corrosion
- elimination of internal clearance due to excessive press fit
- Cage or rolling element failure

Temperature rise

- excess or lack of lubricant
- elimination of the internal clearance
- thrust overloading due to improper mounting

Abnormal running torque

- cage distortion
- lubricant deterioration
- seal damage or displacement

Preventive Control Procedures, and Means of Control

Frequency of control

It essentially depends upon the expected reliability, the material usage, and several other factors

which may be specific to each user. Sampling controls based on the bearing's life expectancy should be regularly performed.

External control means

Some control instruments that detect unusual vibrations are available, e.g., "sonic meters". In any case, a "reference level" should be determined for random comparison, to detect variance.

Failure Identification

Failure identification

It is not always easy to detect failures; though the following steps can be helpful

- record significant facts noticeable on the bearing, and its surrounding components
- identify all probable failure causes
- from the identified causes, select only those causes that match maximum abnormal performance parameters

Before removal

Carefully observe the following, before initiating the removal or dismounting process

- presence of dirt
- temperature increase due to lubricant loss
- noise level
- torque level
- evolution of the bearing deterioration
- orientation of bearing in assembly

After removal

Examine the following before cleaning the bearing; otherwise, a proper condition analysis maybe difficult.

- the condition of cages and rolling elements
- wash bearing, and strain liquid to check presence of particles
- keep lubricant, seals and shields for examination
- keep track of bearing and ring mounting location
- check shaft and housing fits
- examine the mounting surface, e.g. the shaft and its housings.
- examine the shoulders for out of shape squareness, or presence of debris, rust etc.

Types of Failures

1. Spalling - Origin Aspects

Spalling can be found on raceways as well as on rolling elements. It can be deep (fatigue spalling), or shallow. In both cases, causes and symptoms are different.

Spalling Appearances

Fatigue Spalling

Bearings have a limited life expectancy. The operating loads to which they are subjected determine their fatigue life.

Spalling Fatigue Mechanism

When a bearing is subjected to loads, pressures in the raceway and rolling element contact area can be very high. Maximum value shearing forces develop at some thousandths of an inch below the contact surface. These repetitive stresses, caused by the continuous travelling of the rolling elements, initiate the spalling process.

Small cracks may develop in the material, that start at the high stress point and progress to the surface. These cracks eventually join and cause the metal to flake in a rapidly expanding area.

Spalling Aspects

Spalling is a progressive phenomenon that increases more or less rapidly after the appearance of the first crack. Consequently, material spalling must be detected at its early stage; if left unchecked it can lead to a premature bearing failure.

Beginning of Spalling

In the initial stages, Bearing surface may develop some jointless fractures.

Even though the component profile may not change at this stage, but these cracks characterize an underlying fatigue.

Advanced Spalling

The fractures that had developed in initial stages start connecting together in a more advanced Spalling stage. The component profile may still not change, but the surface finish can get badly damaged. Some metal chips may flake and get mixed with the lubricant, and further accelerate destruction.

Final Spalling

In the final stages, the entire bearing surface gets spalled. Metal alterations caused by shearing forces get joined. Spalling destroys component profile, and effects bearing performance.

Shallow Spalling

Shallow spalling is typically characterized by spots that are more or less spread out in the load zone of the raceway surface. A microscopic examination of the effected zone

will show only superficial damage to metal.

Causes

Incorrect (insufficient or improper) lubrication is the basic cause of failure. The oil film may break due to the pressure created by the applied loads, thereby allowing contact between the rolling elements and raceways. This contact causes spot temperatures to rise, resulting in micro-welding, which further causes thin and superficial metal flaking. Shallow spalling is not material fatigue, it is a surface damage.



Spalling Locations

A. Load Zone

Identification

Spalling in the load zone affects most of the raceway width in a Roller Bearing, the bottom of race in a Deep Groove Ball Bearing, and both raceways of a Double Row Ball or Roller Bearing.

Causes

- limited or constant overloading
- improper or inadequate lubricant supply

Preventive Measures

- check bearing loads
- use an adequate supply of appropriate lubricant



B. Edge of Raceway

Identification

For Ball Bearings, the ball path runs from one side of the race to the other, around the non-rotating ring. The rotating ring has a ball path which is wider than usual. Cage fractures might occur in certain cases. For Tapered or Cylindrical Roller Bearings, fatigue areas can be detected on the edge of the raceways. The contact areas vary from one race edge to the other on both rings, but are diametrically opposed on each ring.

Causes

These failures are due to shaft and housing misalignment, that may get initiated either by an improper parallelism between the shaft axis and the housing bore generating line, or a wobble of the housing or shaft shoulders. This can also be observed from shaft bowing while operating. These faulty elements generate a heavy concentration of extra stresses leading to the development of premature bearing fatigue failures in overloaded areas.

Preventive Measures

Shaft and housing alignment should be carefully checked. Housings should be kept clean as some misalignments are due to the presence of foreign matter between the bearing faces and their contact shoulders.

C. On Non-Rotating Ring: Entire Raceways

Identification

A highly visible ball or roller path, or evident spalling even in the part opposite to the load zone, i.e. on the ring stationary in relation to the load, is a definite indication of spalling on the entire raceway.

Causes

Generally, the ring rotating in relation to the load should be mounted with a press fit. The tightness of the fit is dependent on the application requirements. The heavier the load, the tighter the fit. This is to prevent the ring from rotating on the shaft or in the housing.

An excessive interference fit can reduce or eliminate the internal bearing clearance and cause a preload to develop in addition to normal operating loads. This will cause all the rolling elements to come in contact with the raceways.

In addition to premature spalling, an excessive interference fit might generate internal ring stress. These unusual stresses, when added to



the Hertz pressures generate cracks, and even cause ring fractures.

Driving a Tapered Bore Self-Aligning Ball or Spherical Roller Bearing too far up a Tapered Adapter Sleeve would lead to a bearing distress as described above. This action over expands the inner ring, thus reducing or eliminating the internal clearance, and causing dangerous preloading of bearing.

Preventive Measures

Shaft guiding tolerances must be controlled, and gauges must be regularly checked against standards to eliminate chances of inaccurate measurements. When mounting Spherical Roller Bearings on Tapered Adapter Sleeves, a feeler gauge must be used to confirm proper internal clearance after mounting.

D. On Non-Rotating Ring: Particular Areas

Identification

The following are obvious symptoms of spalling on non-rotating ring

- **presence of intensive raceway spalling**
highly visible ball or roller path in two diametrically opposite areas, and sometimes in several points of the ring indicates intensive raceway spalling
- **presence of extended spalling around the raceway's circumference**
Spalling on one edge indicates that only this area has been working, hence it gets effected by

an extended spalling, all around the circumference

Causes

In the first case, distortion comes from the de-shaping of the housing, i.e. ovalization or triangulation. The outer ring follows the housing shape, and visibly evidences an excessive load in the areas corresponding to the squeeze. It can also be the result of foreign particles in the housing, which locally distort the rings. Self-aligning Ball Bearing Rings that are mounted in cast iron or steel housing units, are more susceptible to this kind of failure.

In the second case, damage is characteristic of a tapered housing, where only one ring edge is stressed. For Tapered or Cylindrical Roller Bearings, spalls are located in the highest squeezed area of the ring. For Self-aligning Ball or Roller Bearings, only one row of rolling elements runs with over stresses, hence it gets effected by an extended spalling around the raceway circumference.

Spalling located on this raceway can also be identified by "even fractures of ring edge", which may develop longitudinally because of high Hertz pressures.

Similar faults on inner rings are extremely rare as the distortion amplitude of shafts is not high

enough to produce that type of damage.

Preventive Measures

Housings should be machined only when material is heat stabilized. Along with a dimensional check, a

2. Seizing

Identification

Shallow metal flaking and the appearance of dark areas are significant representatives of a superficial transfer of the metal; original grind or hone marks tend to completely disappear in effected areas.

Brown patterns represent local or generalized over-heating. In more severe conditions, metal flaking, local melting and scoring, may deform the rolling elements.

Causes

Inadequate lubricant causes bearing seizure, as it may lead to a rupture of oil film, allowing metal-to-metal contact between the rolling elements and raceways, which

geometrical check should also be conducted on the housing to detect any deformation (roundness, off taper, etc.).

causes localized overheating and micro-welding.

Tapered Roller Bearings may seize under excessive preloaded condition or due to improper lubrication. It primarily effects the large roller end and the cone back face rib. Seizure often occurs when new equipment is started without appropriate lubrication.

If the bearing fit tolerances on seats are too loose, the shaft might rotate in the bore, or the outer ring might rotate in the housing. This also causes overheating, which could lead to bearing seizure.

High operating speeds can also cause bearing seizure. When the bearing load is light, rolling elements may not rotate instantaneously, either because of their inertia, or because of a rotation slow down caused by the lubricant. Friction due to rotation slow down leads to a temperature rise and consequential expansion leads to seizure between the rolling elements and raceways.

Seizing can also occur under a pure radial load, and more so when an excessively high viscosity lubricant is used. In Roller Bearings, the speed of the rollers which are not in the load zone decreases. They tend to skid, and eventually seize due to overheating of the bearing.

Preventive Measures

Lubrication advice from the equipment manufacturer, or the lubricant supplier, should be carefully followed; including lubrication at proper intervals.

Special care should be taken in greasing Tapered Roller Bearings. Lubricant must be introduced under the cage, towards the large end of rollers. For very high-speed

applications, only that lubricant which allows a prompt rotation of rolling elements should be used. In some instances, the use of a light preload might be required, at start up.

Other Preventive Measures

- investigate suitability of bearing type
- study preload, bearing clearance and fitting
- check precision of shaft and mounting
- improve mounting methods



3. Rolling Element Indentation on Raceways due to Deformation or Metal Flaking

A. On Ball Bearings

Identification

This fault can be identified by presence of ball bearings indentations either all around the perimeter of the races or on in an extended area. These indentations tend to be spaced according to the

ball spacing. Though the bottom of the dent is shiny, marks of original grind can also be seen.

Causes

This failure happens when bearing is subjected to excessively high shock loads, especially when either of the two rings (inner or outer) transfers this shock load to the other, through the balls.

If the shock generates an instantaneous load, which exceeds the known material elasticity limit, ball-race contact points get permanently dented. These dents increase noise levels and initiate future spalling.

Shock loads can be caused by

- **improper mounting method**
untrained operators may erroneously mount the bearing by hammering hard on one ring, to install the opposite ring
- **dropping of bearing on a hard surface**
in this case, the shock load due to accidental dropping gets transferred from the outer ring to the inner ring, through the balls

Preventive Measures

When mounting a bearing ring with a tight fit, impact force should not be applied to the other ring. If the tight fit ring is difficult to reach, it should be pressed with a tubular drift that has a proper shoulder diameter, squareness, and appropriate length.

To handle a bearing properly, a tubular drift can also help guide the ring during the mounting process and protect it from skewing and eventual damage to the shaft-end or housing.



B. On Cylindrical Roller Bearings

Identification

The presence of thin and deep grooves on raceways is considered as a general indication of this damage. More or less evenly spread, these grooves are parallel to their generating line, along with metal

pick up marks which get spaced according to the roller spacing.

Causes

When mounting and assembling, the small space between the diameter over (or under) the rollers and the race diameter of the opposite ring, might cause a pinching of these two elements.

Pinching causes mounting pressure and shock load that leaves scratches on the raceway of the opposite ring.

Preventive Measures

Never force one ring into another. When setting up a Shaft with an installed inner ring, it is recommended to rotate this shaft while mounting it into the outer ring. This rotation will help the rollers to be properly located, thereby prevent their pinching. Similar procedure should be followed while mounting an outer ring into a casting.

Insufficient lubrication (by grease) causes roller pinching and seizing. Hence, it is recommended to thoroughly grease these bearings before assembly, especially if they have been cleaned prior to mounting.

C. On Tapered Roller Bearings

Tapered Roller Bearing components (cup and cone) are mounted separately. This procedure reduces the chances of roller indentations. However, dents might appear if a cone is used to install the cup into its housing.

4. Rolling Elements Indentations on Raceways due to Abrasive Wear

Identification

The presence of dark or shiny indentations on bearing rings, which are more or less spread out and spaced according to the rolling element spacing, is considered as an evidence of this kind of damage. At times, several dents may be seen, which could be either superimposed or interrelated; irrespective, rolling element spacing is always noticeable on dents.

When examined under a microscope, indentations appear to be caused by a total removal rather than a back flow of material, since it occurs when shock loads are applied. In all cases, grinding marks disappear.

This failure is also called “false brinelling”.

Causes

In a stationary bearing, false brinelling is caused by vibrations or small amplitude oscillatory motion of balls between the races. However, it can also affect a rotating bearing, when both rings rotate simultaneously in total synchronism (e.g. Pilot Bearings).

Failure mechanism can be ascribed to

- both pressure and vibrations, which force lubricant out of the loading area causing metal-to-metal contact between rolling elements and races
- vibration stress causes micro-welding or micro-seizing and flaking of metal chips; oxidation impregnates these chips causing abrasive corrosion

This type of failure can be found in bearings

- subjected to intensive vibrations, even when they are mounted on stationary machines
- when both rings rotate at the same speed and consequently remain stationary, in relation to each other

This type of failure can appear in the following application conditions:

- on emergency electrical generators, which are connected to the same platform as the operating generator
- on “off” electrical motors, when mounted on operating machines
- on emergency fans connected with operating fans
- when unbraced machines are transported, and they are subjected to vibrations

Heavier equipment has more intense vibrations, causing greater risk to the bearings.

Preventive Measures

For stationary machinery

- care should be taken to block shafts, when transporting engines, generators or similar equipment, etc.
- periodically rotate (even slow) stationary machines in a vibration area; it will allow lubricant to spread out and avoid exertion of loads at the same spot of the raceways
- large bearings should be stocked flat and kept out of a vibration area (work stations)
- for infrequently operated machinery, it is prudent to use fluid lubricants; as they coat contact

surfaces better, in comparison to more viscous lubricants

For operating machinery

- low viscosity greases should be preferred as they are more efficient
- best resistance to contact corrosion is obtained by using low viscosity lubricating oils
- calcium and lead-calcium soaps are the best to control “false brinelling”



5. Wearing Foreign Matter Indentations

Identification

- by more or less intense development of a visible load path on raceways and rolling elements; raceways might show a continuous sectorial or longitudinal groove
- by excess clearance or by

unbalanced loads and vibrations that might occur

- by wearing of cage material
- by appearance of small dents on the ring path, with slightly rounded edges, which signify material deflection
- abnormal noise levels

Causes

These failures arise from a lack of protection, either when mounting or when operating the bearing.

Often operators do not realise the extent of destruction dust can cause to bearings. Regardless of its origin or texture, dust has a very high abrasive power, and with time, it can lead to excessive internal clearance and unbalanced loads which increase the rate of material fatigue.

Foreign matter indentations have the same origin as wearing. Inadequate protection allows foreign particles to penetrate the bearing. These particles constantly interfere between rolling elements

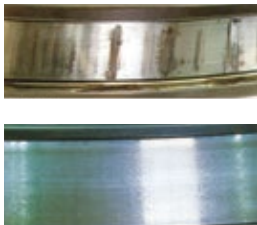

6. Pitting and Fluting

Identification

- **Pitting is represented by local metal smelting**
Microscopic examination will show pits with sharp edges that are joined in a string.

and raceways and can initiate small indentations to make the bearing operation noisier. The deterioration of raceway and rolling element surface finish accelerates material fatigue.

Preventive Measures

- when mounting, clean the shafts and housings
- ensure dust-free working areas
- do not wash new bearings
- protect bearings from dust when stocking
- use clean lubricants; cover lubricant containers when not in use
- wrap any mechanical element, when not in use
- prevent entrance of debris (textile, straws, fibres) or dust (coal, sand, metal chips, chemical products) into the bearings

- **Fluting is a sequence of narrow areas that look like grooves**
These grooves generally follow one another in raceway zones that are subjected to load, and may also appear on rollers

Causes

Pitting and fluting might occur on rotating machines which equip machine tools (railroad equipment or

engines), and the bearing is crossed by a current when it happens to be the only "earthing" link.

- **high amperage current**

Because of the short distance between the raceways and the rolling elements, crossing by high amperage current causes arcing (even through the lubricant). Arcing develops high temperature spots which melt the metal.

- **low amperage current**

Crossing by low amperage current causes alteration of metal surface



7. Shock Load Marks Nicks, Cracks and Fractures

Identification

This failure can be identified by the presence of

- shock load and tool marks on flat surfaces, rolling elements, and radii

texture, which appear as spaced grooves caused by rotation.

- **debris caught in the lubricant**
- **exposure to ambient humidity**
- **poor lubrication**

Preventive Measures

- ensure that machinery and elements are earthed
- check insulation and clean motor connectors to prevent current leakage
- improve sealing to prevent lubricant loss

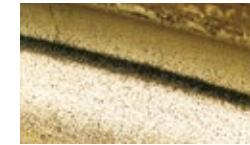

- **nicks and fractures of shoulders and ribs**

Causes

When a bearing ring is subjected to a shock load, i.e. a load over its metal elasticity limits, it may get permanently dented. Shocks can also generate other problems like ring distortion and indentations. In some cases, shocks can cause nicks, cracks, or even fractures.

Cracks are very insidious for they may not be easily visible at first but they gradually cause metal chips to flake, which may penetrate the bearing and damage raceways and rolling elements.

The roller guiding elements of Cylindrical Roller Bearings are particularly sensitive to shocks, and consequently prone to this failure. In several cases, fractures have been noticed on Spherical Roller Bearings. When the outer ring swivels, one or several rollers can get dislocated in their cage pockets. Re-positioning them is not easy, as after dislocation the rollers tend to wedge in between the external face of the outer ring and one shoulder of the inner ring. When the rollers are dislocated, any shock load on the outer ring forcing it to swivel back gets transmitted through the rollers to the shoulder of the inner ring.

Fractures occur very often, and typically their spacing corresponds to the exact roller spacing.



Preventive Measures

- Rings and shoulders should not be hammered
- when mounting, always use a tubular drift between the hammer and bearing to evenly distribute shock forces around the ring circumference
- to mount Tapered, Cylindrical, or Spherical Roller Bearings on a shaft using an interference fit, the inner ring should be first expanded by heating in an approved manner
- to relocate the swivelled outer ring of a Spherical Roller Bearing, carefully rotate it while realigning the dislocated rollers
- do no close bearings forcefully

8. Ring Fractures

Identification

This fault is identified by fractures which maybe transverse or otherwise. These fractures can affect large ring areas also.

Causes

- due to the overloading of the outer ring
internal clearance may get eliminated; an internal preload may develop due to an excessive press fit of the inner ring on the shaft

- excessive radial stresses
it may result in multiple fractures of the ring
- excessive interference fit
transverse fractures of inner rings are caused by metal over stress due to excessive interference fit

Preventive Measures

To avoid this type of bearing failure, while mounting a bearing, care should be taken to

- ensure appropriate fitting tolerances
this is to avoid elimination of internal clearance, and prevent

- preloading of the Bearing
- use a Bearing with increased internal clearance
especially if heavy press fit method is employed to mount Bearing

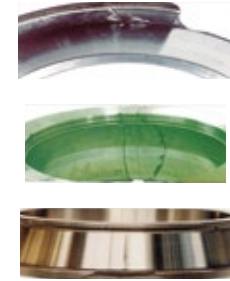

9. Creep

coated with a brown paste, which is a result of mixing of rust and lubricant. Deep corrosion can break thin rings under load.

Identification

The appearance of pink, brown or black spots on the bore, or on the outside diameter or faces of the bearing indicates creep.

Microscopic examination of the area will show a deep attack on the surfaces. When rubbed, these spots leave rust marks. In cases of severe damage, rings and raceways get

Causes

An interference fit is required for rotating rings. An insufficient or non-existent fit will cause a slow turn of shaft, in relation to the inner ring (or the outer ring of the housing). This metal-to-metal motion picks up thin metal flakes from the bearing or shaft (or housing) and cause local seizing.

Flake particles tend to oxidize rapidly, in the absence of a lubricant. Their combined abrasive power further accelerates this process. Rough and granular housing surfaces are more prone to creep.

When bearings rotate or vibrate on their seats, contact corrosion also appears on their faces. This can happen when axial clamping is insufficient, or it loosens due to a



10. Corrosion

Identification

This fault is assumed to have set in when reddish or black spots appear, along with surface deterioration (including formation of cavities), due to a local or full oxidation of the bearing, including raceways, rolling elements, cage, face, bore outside diameter.

shim collapse, or a lock nut release. The corresponding bearing face tends to develop a hollow wear mark of the shoulder.

Preventive Measures

- both the geometry and the fitting tolerances of shafts and housings must be controlled to provide an adequate press fit
- ensure proper tightness of lock nuts, or housing end caps whenever used for mounting a bearing
- re-work the shaft surface as part of maintenance
- use special anti-seizing products on bearing seats and shoulders

Causes

- damage can be due to corrosive liquids or high humidity levels
- faulty sealing of the assembly

Corrosion can be systematic when bearings operate in a very damp environment and are subjected to frequent and long “on and off” operating cycles. When “on” the bearing’s temperature rises, causing the air in the housing to expand and

leak out. Long “off” period allows the bearing temperature to return to ambient levels and permits the humid air to flow back and cause condensation.

Repetitive “on and off” cycles progressively increase moisture deposits, which never get completely eliminated in the “on” phase. This moisture tends to mix with the grease and reduces the quality of



11. Discoloration

the lubrication. Eventually, corrosion spreads to all the internal elements.

The results of corrosion are similar to those of abrasive dust. Oxides flake under the rolling element loads, and the abrasive tendency of this mixture further accelerates bearing failure.

Preventive Measures

- use adequate shields or seals for improved protection
- control ambient conditions
- avoid direct exposure of seals and shields to liquid
- use lubricants that do not emulsify with water
- impart anti-rust treatment for extended periods of a bearing’s non-usage
- improve storage methods

Identification

This fault is identified by a brownish discolouration of the rings and rolling elements.

Causes

The most common cause of this failure is superficial oxidation and polymerization of lubricant, at high temperature. Heating of a bearing expands its rings to facilitate mounting. However, overheating

may cause the surface colour to develop a brownish discolouration. This burn-out might also occur if the bearing is heated by an open flame, or by a nonadjustable temperature stove, or by an uncontrolled oil bath.

Rise in bearing temperature and resultant discoloration can happen either due to internal reasons or external heat sources.

Besides facilitating movement, lubrication also maintains a thermal balance by evenly distributing internal heat, which eventually gets transferred to the external environment through the bearing's body. An inadequate supply or incorrect choice of lubricant can lower the thickness of the lubricant film between the rolling contact surfaces, leading to an internal thermal imbalance, and consequential rise in the bearing's temperature.

Also, if there is an elimination of clearance because of excessive press fit of rings in or on their seats, the preload increases assembly temperature.

Temperature rise can also happen under normal operating conditions, especially if excessive quantity of grease is forced into reduced spaces. Acting as a brake, it slows the rotation and causes the bearing to overheat.

An excessive rotating speed can also overheat the bearing and discolour the steel.

Temperature rise can also happen due to external sources like dryer cylinders, foundry motors, furnace wagons, etc. To maintain appropriate internal clearances, it is essential to consider these factors when deciding on the type of lubricant or on mounting tolerances.

Preventive Measures

- do not excessively grease
- choose appropriate lubricant
- frequently check lubricant supply
- check fits to avoid abnormal preloading
- allow the bearing to cool
- reduce external causes of temperature rise



12. Cage Failures

A. Distortion

Identification

Distortion of cages, or squeezing of cage pockets, or shock load marks are obvious failure signs. Identification of this failure is difficult, as sometimes symptoms are hidden by side effects such as over-heating, cage scoring due to rolling element friction, seizing, etc.

Causes

- exposure of bearings to physical shocks before mounting
- improper mounting

A ball bearing cage is very fragile; it is nearly flush with the ring faces and therefore prone to tool damage. A Tapered Roller Bearing cage protrudes beyond the cone front face, and use of improper installation tools can damage it. When bearings are hammered for mounting, tools may slip and distort the cage pockets, leading to pinching of the corresponding rolling elements.

Preventive Measures

Use a press to install a bearing whenever possible, to avoid severe impact and shock. When hammering cannot be avoided (for replacement essentially), use tubular drifts with the same shoulder diameter as the ring to be fitted. This procedure is highly recommended for a press fit mounting of a cone, especially when pushing on its front face.

B. Wearing

Identification

In this fault, cage pockets and the inside and outside diameters develop severe wear characteristics.



Causes

Abrasive particles might penetrate while mounting, but the chances of this to happen are more under operating conditions. In ball bearings, abrasion enlarges cage pockets, which leads to an increased

clearance and consequential physical imbalance. This imbalance enhances pocket wear, as the outside diameter of the cage now rubs against the outer ring, and its inside diameter rubs against the inner ring. In Tapered Roller Bearings, this imbalance may wear the cage bridge or even fracture it.

Preventive Measures

- carefully clean the bearing seat and its housing, to eliminate abrasive particles
- replace worn or damaged seals
- use special, and more efficient seals for Ball or Tapered Roller Bearings
- use clean lubricant, and store it only in covered containers when not in use

C. Fracture

Identification

Fractures can happen with or without scoring under the rolling elements.

Causes

- Cage fractures can be caused by
- severe cage damage during mounting
 - seizure due to improper lubrication
 - sudden acceleration or deceleration can lead to cage pocket distortion
 - cage over speeding (ball bearings)
 - elimination of internal clearance from excessive press fit

- excessive differential temperatures between the inner and outer ring
- constant change in direction caused by alternative or repetitive overturning moments on ball bearings
- differential speeds between balls cause repetitive pulling stresses on cages, leading to metal fatigue and eventual fractures
- deformation of housings caused by uncontrolled or unbalanced loads, etc.

Preventive Measures

- avoid cage damage during mounting
- use proper lubricant
- ensure sufficient lubricant quantity
- control acceleration and deceleration
- check maximum rpm (speed) required from bearing, and verify its design suitability
- check fitting tolerances and operating temperature
- use appropriate type of cage, for alternating overturning moments.



Bearing Data and Specifications

1. Bearing Technical Data

Dimensions

Bearings boundary dimensions are defined in the International Organization for Standardization (ISO):

Metric Radial Bearings except Taper roller bearing are in standard ISO 15

Metric Radial Taper Roller Bearings are in standard ISO 355

Metric Thrust Rolling Bearings are in standard ISO 104

Inch Taper roller bearings are in standard AFBMA Standard 19 (ANSI B3.19)

Basic Rating Life

The Basic rating life of bearing, calculation is in accordance with ISO 281 for Dynamic load rating and ISO 76 for Static load rating of Bearing.

Dynamic load rating: The load of Constant magnitude and direction that sufficiently large number of apparently identical bearings can endure for basic rating life of 1 Million revolutions.

Static load rating: The load under normal condition causes permanent deformation at contact points of approx..0.01 % of Rolling element diameter.

Speed

There is a limit to the speed at which rolling bearings can be operated, the temperature limit of the lubricant or the material of the bearing components sets the speed limit. The speed at which a bearing reaches its operating

temperature limit depends on the heat generated in the bearing any externally applied heat, and the amount of heat that can be transferred away from the bearing.

In this catalogue, 2 speeds are listed reference speed (thermal) and limiting speed (mechanical).

Reference speed: The speed capabilities of a bearing based on standardized reference values for the heat flow density as established in ISO 15312.

Limiting speed: The speed is determined lubrication, the form stability or strength of the cage, lubrication of cage guiding surfaces, centrifugal and gyratory forces acting on the rolling elements, bearing housing precision and other speed-limiting factors, such as shields/seals and the lubricant for sealed bearings.

2. Bearing Specifications

The Dimensions and Running Accuracy of Rolling Bearings has been standardized internationally in ISO as per different precision class, PN (P0), P6, P5, P4 etc.

2.1 Dimensional and Geometrical Tolerances of Rolling Bearings

2.1.1 Symbol definition

d	Nominal bearing bore diameter
Δdmp	Single plane mean bore diameter deviation (for tapered bore only as per theoretical inner bore)
Vdp	Bore diameter variation in a single radial plane
Vdmp	Mean bore diameter variation
D	Nominal bearing outside diameter
ΔDmp	Single plane mean outside diameter deviation
VDp	Outside diameter variation in a single radial plane
VDmp	Mean outside diameter variation
B	Nominal bearing width of inner ring
VBs	Deviation of a single inner ring width
ΔBs/ΔCs	Deviation of single inner ring/Outer ring width
C	Nominal bearing width of outer ring
VCs	Deviation of a single outer ring width
Kia	Radial runout of assembled bearing inner ring
Kea	Radial runout of assembled bearing outer ring
T	Nominal assemble bearing width
ΔTs	Deviation of assemble bearing width
Sia	Axial runout of assembled bearing inner ring
Sea	Axial runout of assembled bearing outer ring
ΔHs	Deviation in center height of bearing units

2.1.2. Tolerance Values for Radial Bearings

(Except Taper Roller Bearings)

Table 2.1.2.1 Class P0 Inner Ring Unit: μm

d mm		Δdmp		Vdp			Vdmp	Kia	ΔBs		VBs
				Diameter series							
				7,8,9	0,1	2,3,4					
Over	Incl.	High	Low	Max	Max	Max	High	Low	Max		
	2.5	0	-8	10	8	6	6	10	0	-40	12
2.5	10	0	-8	10	8	6	6	10	0	-120	15
10	18	0	-8	10	8	6	6	10	0	-120	20
18	30	0	-10	13	10	8	8	13	0	-120	20
30	50	0	-12	15	12	9	9	15	0	-120	20
50	80	0	-15	19	19	11	11	20	0	-150	25
80	120	0	-20	25	25	15	15	25	0	-200	25
120	150	0	-25	31	31	19	19	30	0	-250	30
150	180	0	-25	31	31	19	19	30	0	-250	30
180	250	0	-30	38	38	23	23	40	0	-300	30
250	315	0	-35	44	44	26	26	50	0	-350	35
315	400	0	-40	50	50	30	30	60	0	-400	40
400	500	0	-45	56	56	34	34	65	0	-450	50

Table 2.1.2.2 Class P0 Outer Ring Unit: μm

D mm		ΔDmp		VDp			Seal or Shield	VDmp	Kea	ΔCs VCs
				Diameter series						
				7,8,9	0,1	2,3,4				
Over	Incl.	High	Low	Max	Max	Max	Max	Max	Max	
	6	0	-8	10	8	6	10	6	15	Values are identical to those Inner ring
6	18	0	-8	10	8	6	10	6	15	
18	30	0	-9	12	9	7	12	7	15	
30	50	0	-11	14	11	8	16	8	20	
50	80	0	-13	16	13	10	20	10	25	
80	120	0	-15	19	19	11	26	11	35	
120	150	0	-18	23	23	14	30	14	40	
150	180	0	-25	31	31	19	38	19	45	
180	250	0	-30	38	38	23		23	50	
250	315	0	-35	44	44	26		26	60	
315	400	0	-40	50	50	30		30	70	
400	500	0	-45	56	56	34		34	80	
500	630	0	-50	63	63	38		38	100	
630	800	0	-75	94	94	55		55	120	

Table 2.1.2.3 Class P6 Inner Ring Unit: μm

d mm		Δdmp		Vdp			Vdmp	Kia	ΔBs		VBs
				Diameter series							
				7,8,9	0,1	2,3,4					
Over	Incl.	High	Low	Max	Max	Max	High	Low	Max		
	2.5	0	-7	9	7	5	5	5	0	-40	12
2.5	10	0	-7	9	7	5	5	6	0	-120	15
10	18	0	-7	9	7	5	5	7	0	-120	20
18	30	0	-8	10	8	6	6	8	0	-120	20
30	50	0	-10	13	10	8	8	10	0	-120	20
50	80	0	-12	15	15	9	9	10	0	-150	25
80	120	0	-15	19	19	11	11	13	0	-200	25
120	150	0	-18	23	23	14	14	18	0	-250	30
150	180	0	-18	23	23	14	14	18	0	-250	30
180	250	0	-22	28	28	17	17	20	0	-300	30
250	315	0	-25	31	31	19	19	25	0	-350	35
315	400	0	-30	38	38	23	23	30	0	-400	70
400	500	0	-35	44	44	26	26	35	0	-450	70

Table 2.1.2.4 Class P6 Outer Ring

Unit: μm

D mm		ΔDmp		VDp				VDmp	Kea	ΔCs VCs
				Diameter series			Seal or Shield			
				7,8,9	0,1	2,3,4				
Over	Incl.	High	Low	Max			Max	Max		
6	18	0	-7	9	7	5	9	5	8	Values are identical to those Inner ring
18	30	0	-8	10	8	6	10	6	9	
30	50	0	-9	11	9	7	13	7	10	
50	80	0	-11	14	11	8	16	8	13	
80	120	0	-13	16	16	10	20	10	18	
120	150	0	-15	19	19	11	25	11	20	
150	180	0	-18	23	23	14	30	14	23	
180	250	0	-20	25	25	15		15	25	
250	315	0	-25	31	31	19		19	30	
315	400	0	-28	35	35	21		21	35	
400	500	0	-33	41	41	25		25	40	
500	630	0	-38	48	48	29		29	50	
630	800	0	-45	56	56	34		34	60	

2.1.3. Tolerance Values for Metric Tapered Roller Bearings

Table 2.1.3.1 Class P0 Inner Ring

Unit: μm

d mm		Δdmp		VDp	VDmp	Kia	$\Delta\text{Bs}, \Delta\text{Cs}$		ΔTs	
Over	Incl.	High	Low	Max	Max	Max	High	Low	High	Low
10	18	0	-12	12	9	15	0	-120	+200	0
18	30	0	-12	12	9	18	0	-120	+200	0
30	50	0	-12	12	9	20	0	-120	+200	0
50	80	0	-15	15	11	25	0	-150	+200	0
80	120	0	-20	20	15	30	0	-200	+200	-200
120	180	0	-25	25	19	35	0	-250	+350	-250
180	250	0	-30	30	23	50	0	-300	+350	-250
250	315	0	-35	35	26	60	0	-350	+350	-250
315	400	0	-40	40	30	70	0	-400	+400	-400
400	500	0	-45	45	34	80	0	-450	+450	-450

Table 2.1.3.1 Class P0 Outer Ring

Unit: μm

D mm		ΔDmp		VDp	VDmp	Kea
Over	Incl.	High	Low	Max	Max	Max
18	30	0	-12	12	9	18
30	50	0	-14	14	11	20
50	80	0	-16	16	12	25
80	120	0	-18	18	14	35
120	150	0	-20	20	15	40
150	180	0	-25	25	19	45
180	250	0	-30	30	23	50
250	315	0	-35	35	26	60
315	400	0	-40	40	30	70
400	500	0	-45	45	34	80
500	630	0	-50	50	38	100
630	800	0	-75			120

2.1.4. Tolerance Values for Thrust Bearings

Table 2.4.4.1 Ring Unit: μm

d mm		Δdmp or Δd2mp		Vdp or Vd2p	Si or Se	D mm		ΔDmp		VDp
Over	Incl.	High	Low	Max	Max	Over	Incl.	High	Low	Max
	18	0	-8	6	10	10	18	0	-11	8
18	30	0	-10	8	10	18	30	0	-13	10
30	50	0	-12	9	10	30	50	0	-16	12
50	80	0	-15	11	10	50	80	0	-19	14
80	120	0	-20	15	15	80	120	0	-22	17
120	180	0	-25	19	15	120	180	0	-25	19
180	250	0	-30	23	20	180	250	0	-30	23
250	315	0	-35	26	25	250	315	0	-35	26
315	400	0	-40	30	30	315	400	0	-40	30
400	500	0	-45	34	30	400	500	0	-45	34

Table 2.4.4.2 Height Unit: μm

d mm		ΔTs		ΔT1s	
Over	Incl.	High	Low	High	Low
	30	+20	-250	+150	-400
30	50	+20	-250	+150	-400
50	80	+20	-300	+150	-500
80	120	+25	-300	+200	-500
120	180	+25	-400	+200	-600
180	250	+30	-400	+250	-600
250	315	+40	-400		
315	400	+40	-500		
400	500	+50	-500		

2.1.5. Tolerance Values for Tapered Roller Bearings – Inch Series

Table 2.1.5.1 Inner Ring Unit: μm

d mm		Δdmp		ΔTs		ΔBs		Kia	Sia
Over	Incl.	High	Low	High	Low	High	Low	Max	Max
	76.2	+13	0	+203	0	+76	-254	51	51
76.2	101.6	+25	0	+203	0	+76	-254	51	51
101.6	152.4	+25	0	+356	-254	+76	-254	51	51

Table 2.1.5.2 Outer Ring Unit: μm

D mm		ΔDmp		ΔCs		Kea	Sea
Over	Incl.	High	Low	High	Low	Max	Max
	266.7	+25	0	+51	-254	51	51
266.7	304.8	+25	0	+51	-254	51	51
304.8	609.6	+51	0	+51	-254	51	51

Tolerance Values for Inner ring or Outer ring components with standard ring of bearing the nominal width

Table 2.1.5.3 Height Unit: μm

d mm		ΔT1s		ΔT2s	
Over	Incl.	High	Low	High	Low
	76.2	+102	0	+102	0
76.2	101.6	+102	0	+102	0
101.6	152.4	+152	-152	+203	-102

3. Bearing Clearances

Bearing clearance is defined as total distance through which one bearing ring can be moved relative to other in **Radial direction** which is called as **Radial internal clearance** and or in **Axial direction** which is called as **Axial internal clearance**.

Radial internal clearance

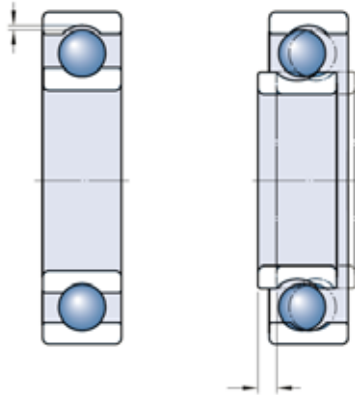

Axial internal clearance

Bearing Internal Clearance designations

- C1** Smaller than C2
- C2** Smaller than Normal (CN)
- CN** Normal Clearance, generally if there is no CN suffix in bearing number considered as CN
- C3** Greater than CN
- C4** Greater than C3
- C5** Greater than C4

3.1. Radial internal clearance of Deep Groove Ball bearing

Table 3.1.1

Unit: μm

d (mm)		C2		CN(normal)		C3		C4		C5	
Over	Incl	Min	Max	Min	Max	Min	Max	Min	Max	Min	Max
2.5	6	0	7	2	13	8	23				
6	10	0	7	2	13	8	23	14	29	20	37
10	18	0	9	3	18	11	25	18	33	25	45
18	24	0	10	5	20	13	28	20	36	28	48
24	30	1	11	5	20	13	28	23	41	30	53
30	40	1	11	6	20	15	33	28	46	40	64
40	50	1	11	6	23	18	36	30	51	45	73
50	65	1	15	8	28	23	43	38	61	55	90
65	80	1	15	10	30	25	51	46	71	65	105
80	100	1	18	12	36	30	58	53	84	75	120
100	120	2	20	15	41	36	66	61	97	90	140
120	140	2	23	18	48	41	81	71	114	105	160
140	160	2	23	18	53	46	91	81	130	120	180
160	180	2	25	20	61	53	102	91	147	135	200
180	200	2	30	25	71	63	117	107	163	150	230
200	225	2	35	25	85	75	140	125	195	175	265
225	250	2	40	30	95	85	160	145	225	205	300
250	280	2	45	35	105	90	170	155	245	225	340
280	315	2	55	40	115	100	190	175	270	245	370
315	355	3	60	45	125	110	210	195	300	275	410
355	400	3	70	55	145	130	240	225	340	315	460
400	450	3	80	60	170	150	270	250	380	350	510
450	500	3	90	70	190	170	300	280	420	390	570

3.2. Radial internal clearance of Cylindrical roller bearings and Needle roller bearings

Table 3.2.1 Cylindrical bore

Unit: μm

d (mm)		C2		CN(normal)		C3		C4		C5	
Over	Incl	Min	Max	Min	Max	Min	Max	Min	Max	Min	Max
	10	0	25	20	45	35	60	50	75		
10	24	0	25	20	45	35	60	50	75	65	90
24	30	0	25	20	45	35	60	50	75	70	95
30	40	5	30	25	50	45	70	60	85	80	105
40	50	5	35	30	60	50	80	70	100	95	125
50	65	10	40	40	70	60	90	80	110	110	140
65	80	10	45	40	75	65	100	90	125	130	165
80	100	15	50	50	85	75	110	105	140	155	190
100	120	15	55	50	90	85	125	125	165	180	220
120	140	15	60	60	105	100	145	145	190	200	245
140	160	20	70	70	120	115	165	165	215	225	275
160	180	25	75	75	125	120	170	170	220	250	300
180	200	35	90	90	145	140	195	195	250	275	330
200	225	45	105	105	165	160	220	220	280	305	365
225	250	45	110	110	175	170	235	235	300	330	395
250	280	55	125	125	195	190	260	260	330	370	440
280	315	55	130	130	205	200	275	275	350	410	485
315	355	65	145	145	225	225	305	305	385	455	535
355	400	100	190	190	280	280	370	370	460	510	600
400	450	110	210	210	310	310	410	410	510	565	665
450	500	110	220	220	330	330	440	440	550	625	735

Table 3.2.2 Tapered bore

Unit: μm

d (mm)		C2		CN(normal)		C3		C4		C5	
Over	Incl	Min	Max	Min	Max	Min	Max	Min	Max	Min	Max
	24	15	40	30	55	40	65	50	75	70	95
24	30	20	45	35	60	45	70	55	80	75	100
30	40	20	45	40	65	55	80	70	95	90	115
40	50	25	55	45	75	60	90	75	105	105	135
50	65	30	60	50	80	70	100	90	120	125	155
65	80	35	70	60	95	85	120	110	145	145	180
80	100	40	75	70	105	95	130	120	155	175	210
100	120	50	90	90	130	115	155	140	180	200	240
120	140	55	100	100	145	130	175	160	205	225	270
140	160	60	110	110	160	145	195	180	230	255	305
160	180	75	125	125	175	160	210	195	245	280	330
180	200	85	140	140	195	180	235	220	275	305	360
200	225	95	155	155	215	200	260	245	305	340	400
225	250	105	170	170	235	220	285	270	335	375	440
250	280	115	185	185	255	240	310	295	365	415	485
280	315	130	205	205	280	265	340	325	400	465	540
315	355	145	225	225	305	290	370	355	435	515	595
355	400	165	255	255	345	330	420	405	495	580	670
400	450	185	285	285	385	370	470	455	555	650	750
450	500	205	315	315	425	410	520	505	615	720	830

3.3. Radial internal clearance of Spherical roller bearings

Table 3.3.1 Cylindrical bore

Unit: μm

d (mm)		C2		CN(normal)		C3		C4		C5	
Over	Incl	Min	Max	Min	Max	Min	Max	Min	Max	Min	Max
14	18	10	20	20	35	35	45	45	60	60	75
18	24	10	20	20	35	35	45	45	60	60	75
24	30	15	25	25	40	40	55	55	75	75	95
30	40	15	30	30	45	45	60	60	80	80	100
40	50	20	35	35	55	55	75	75	100	100	125
50	65	20	40	40	65	65	90	90	120	120	150
65	80	30	50	50	80	80	110	110	145	145	180
80	100	35	60	60	100	100	135	135	180	180	225
100	120	40	75	75	120	120	160	160	210	210	260
120	140	50	95	95	145	145	190	190	240	240	300
140	160	60	110	110	170	170	220	220	280	280	350
160	180	65	120	120	180	180	240	240	310	310	390
180	200	70	130	130	200	200	260	260	340	340	430
200	225	80	140	140	220	220	290	290	380	380	470
225	250	90	150	150	240	240	320	320	420	420	520
250	280	100	170	170	260	260	350	350	460	460	570
280	315	110	190	190	280	280	370	370	500	500	630
315	355	120	200	200	310	310	410	410	550	550	690
355	400	130	220	220	340	340	450	450	600	600	750
400	450	140	240	240	370	370	500	500	660	660	820
450	500	140	260	260	410	410	550	550	720	720	900

Table 3.3.2 Tapered bore



Unit: μm

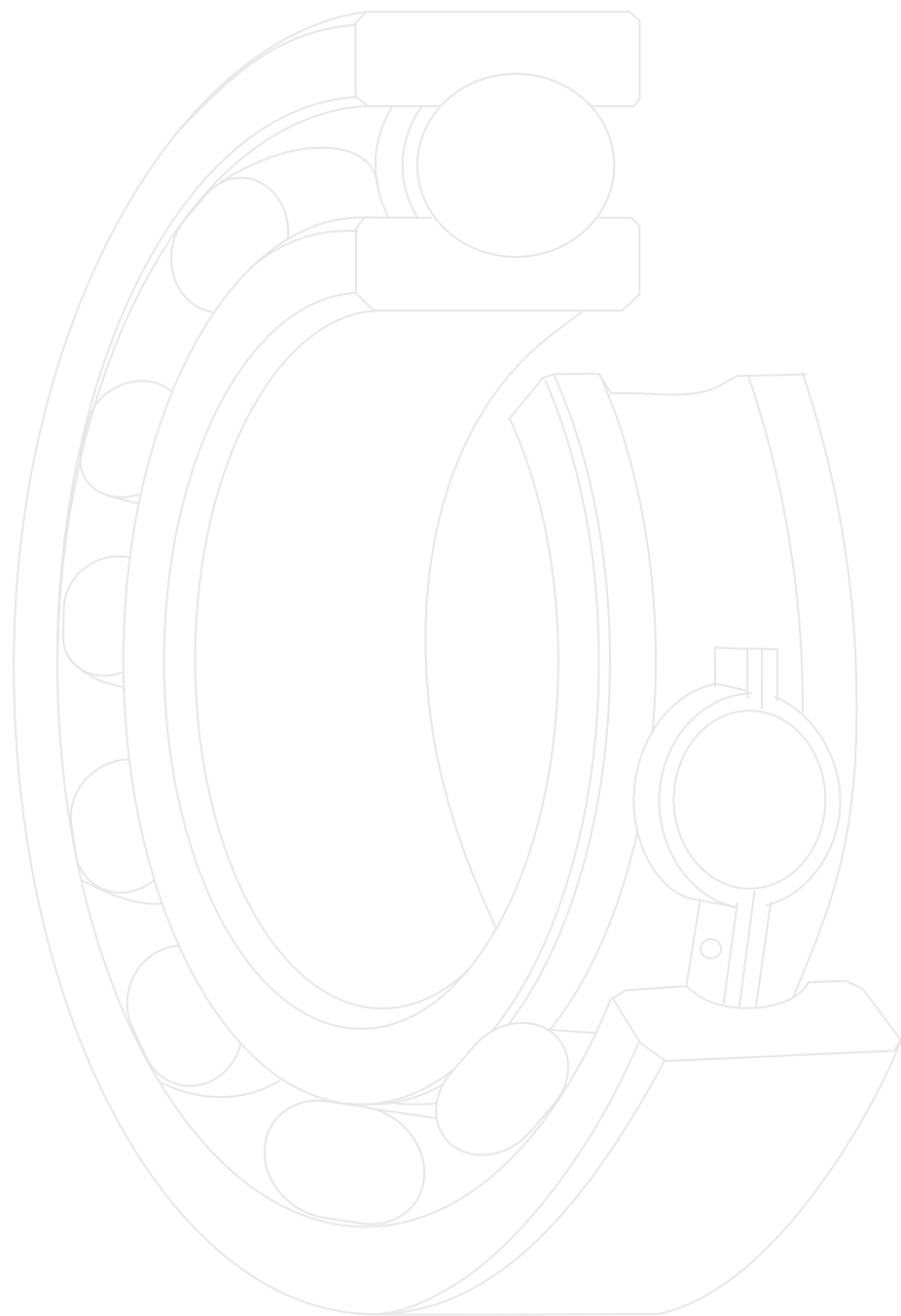





d (mm)		C2		CN(normal)		C3		C4		C5	
Over	Incl	Min	Max	Min	Max	Min	Max	Min	Max	Min	Max
18	24	15	25	25	35	35	45	45	60	60	75
24	30	20	30	30	40	40	55	55	75	75	95
30	40	25	35	35	50	50	65	65	85	85	105
40	50	30	45	45	60	60	80	80	100	100	130
50	65	40	55	55	75	75	95	95	120	120	160
65	80	50	70	70	95	95	120	120	150	150	200
80	100	55	80	80	110	110	140	140	180	180	230
100	120	65	100	100	135	135	170	170	220	220	280
120	140	80	120	120	160	160	200	200	260	260	330
140	160	90	130	130	180	180	230	230	300	300	380
160	180	100	140	140	200	200	260	260	340	340	430
180	200	110	160	160	220	220	290	290	370	370	470
200	225	120	180	180	250	250	320	320	410	410	520
225	250	140	200	200	270	270	350	350	450	450	570
250	280	150	220	220	300	300	390	390	490	490	620
280	315	170	240	240	330	330	430	430	540	540	680
315	355	190	270	270	360	360	470	470	590	590	740
355	400	210	300	300	400	400	520	520	650	650	820
400	450	230	330	330	440	440	570	570	720	720	910
450	500	260	370	370	490	490	630	630	790	790	1000
500	560	290	410	410	540	540	680	680	870	870	1100



Bearings Portfolio

Product Portfolio Index

1. Deep Groove Ball Bearings	92	
2. Self Aligning Ball Bearings	126	
3. Angular Contact Ball Bearings	134	
4. Four Point Contact Ball Bearings	146	
5. Cylindrical Roller Bearings	152	
6. Needle Roller Bearings	170	
7. Tapered Roller Bearings	206	
8. Spherical Roller and Plain Bearings	262	

9. Rod end Bearings	288	
10. Linear Motion Ball Bearings	294	
11. Thrust Ball, Cylindrical Roller, Spherical Roller Bearings	298	
12. Insert Ball Bearing and Pillow Blocks	324	
13. Plumber blocks Housings	370	
14. Adapter and Withdrawal Sleeves	380	
15. Other type of Bearings	406	

Deep Groove Ball Bearings (Single and Double Row)

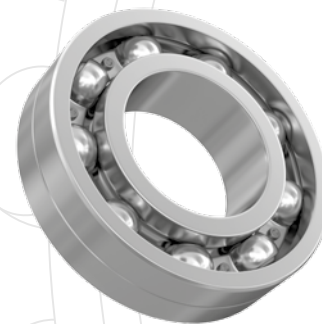

Deep Groove Ball Bearings

The versatility offered by Deep Groove Ball Bearings makes them most popular of all Bearing types.

They are simple in design. KG Deep Groove Ball Bearings are available in a wide range, as defined by the ISO standard plan. These could also be made to meet customer's special dimensional requirements, but within some basic design limitations. These bearings are also available in Stainless Steel material.



Deep Groove Ball Bearings

Deep Groove Ball Bearings are

- Capable of carrying load in either direction, with relatively higher radial load carrying capacity
- Suitable for low or medium load applications
- Suitable for low, medium or even high speed applications; depending on the type and precision of selected Bearing
- Well suited for applications that require high running accuracy
- Suitable for low noise and low torque applications

KG can offer following variants

- Single and Double Row type
- Open basic design type
- As Sealed types
- With Snap Ring groove
- With Snap Ring groove and Snap Ring
- With C2, CN, C3, C4 and C5 radial clearance
- Standard precision grade (ISO Grade 0 - ABEC1) and higher precision grade (ISO Grade 1 - ABEC3)
- With extended Inner Ring
- Pressed Steel, riveted, Plastic and machined Brass Cage
- With stainless steel material with prefix "SS"

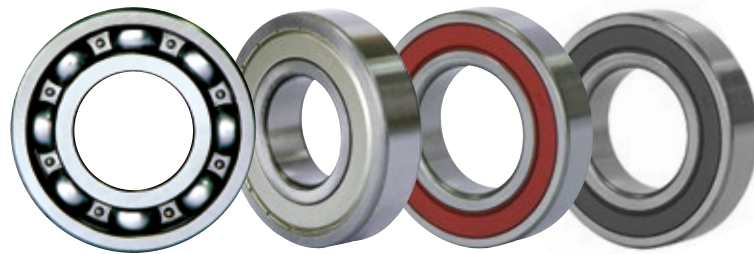

Open and closed types (with Metallic -ZZ shields and Rubber Seals-2RS)

Deep Groove Ball Bearings

Apart from the list of items presented in the following pages, many other special type of KG Deep Groove Ball Bearings have been developed to meet specific application requirements. Technical information for such Bearings, is available on request.

KG standard suffixes for Deep Groove Ball Bearings

A	Modified internal design.
C2	Radial internal clearance less than normal.
CN	Normal radial internal clearance. Generally, no special suffix is used in KG Bearings for normal radial internal clearance.
C3	Radial internal clearance higher than normal.
C4	Radial internal clearance higher than C3.
C5	Radial internal clearance higher than C4.
E	Electric motor quality.
G1-G15	KG internal grease type codes. For details, please contact KG International FZCO.
J	Pressed Steel Cage.
K	Tapered bore, with taper of 1:12.
M	Machined Brass Cage.
N	Snap Ring groove in the Outer Ring.
NR	Snap Ring groove in the Outer Ring, with Snap Ring.
P or TN	Plastic / Polyamide / Nylon Cage.
P5	Dimensional and running accuracy confirming to ISO class 5.
P6	Dimensional and running accuracy confirming to ISO class 6.
Q1-Q8	KG internal reference codes. For details please contact KG International FZCO.
RS	Rubber Seal with Steel sheet reinforcement on one side of the Bearing.
RSL	Double lip type Rubber Seal with special groove in the Inner Ring, fixed only at one side of Bearing.
2RS	Rubber Seal with Steel sheet reinforcement on both sides of the Bearing.
2RSL	Double lip type Rubber Seal with special groove in the Inner Ring, fixed at both Bearing sides.
Z	Metallic shield on one side of the Bearing.
ZZ	Metallic shield on both sides of the Bearing.
F	Used as a prefix for a Flange on Outer Ring.

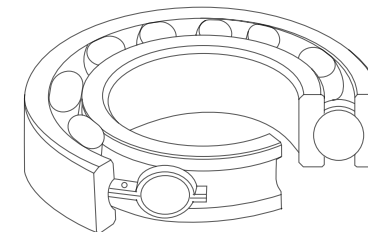

Note: Most of the Bearings listed in the following pages of this chapter are available with above suffixes, subject to design or manufacturing constraints.



Miniature and Extra Small Ball Bearings

Deep Groove Ball Bearings with an outer diameter less than 9 mm are known as Miniature Ball Bearings. Deep Groove Ball Bearings having an outside diameter more than 9 mm, and bore diameter less than 10 mm are known as Extra Small Ball Bearings.

They are available in a wide range, as defined by the ISO standard plan. These types could also be made to meet customer's special dimensional requirements, but with some basic design limitations.

These bearings are also available in Stainless Steel material.

Miniature and Extra Small Ball Bearings are

- Capable of carrying relatively smaller loads
- Suitable for low, medium and high speed applications
- Suited for low noise and low torque applications

Apart from the list of items presented in the following pages, many other special type of KG Miniature and Extra Small Ball Bearings have been developed to meet specific application requirements. Technical information for such Bearings, is available on request.



Magneto Ball Bearings

Magneto bearings have a design similar to a Radial bearing. The groove in the inner ring is a little shallower than that of deep groove ball bearings and one side of the outer ring is relieved. The outer ring have only one shoulder and separable, which makes it convenient for mounting.



Double Row Deep Groove Ball Bearings

It corresponds in design to single row deep groove ball bearings. They have deep uninterrupted raceways and high conformity between the balls and raceways. They are able to carry axial loads acting in both directions in addition to radial loads.

Double row deep groove ball bearings are very suitable for bearing arrangements where the load carrying capacity of a single row bearing is inadequate. For the same outside and bore diameters, double row bearings are slightly wider than single row bearings but have considerably higher load carrying capacity than single row bearings in the 62 and 63 series.



Single Row Series: 6000

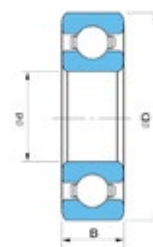

Principal dimensions			Designation			Basic Load Ratings		Speed Ratings		Mass
d	D	B				Dynamic C	Static C ₀	Reference speed	Limiting speed	
mm						N	r/min		kg	
3	10	4	603	603 ZZ	603 2RS	553	203	49,500	66,000	0.0014
4	12	4	604	604 ZZ	604 2RS	806	280	120,000	75,000	0.0021
5	14	5	605	605 ZZ	605 2RS	1050	500	100,000	60,000	0.0045
6	17	6	606	606 ZZ	606 ZZ	1940	720	95,000	58,000	0.006
7	19	6	607	607 ZZ	607 2RS	2340	950	85,000	53,000	0.008
8	22	7	608	608 ZZ	608 2RS	3450	1370	75,000	48,000	0.012
9	24	7	609	609 ZZ	609 2RS	3900	1660	70,000	43,000	0.014
10	26	8	6000	6000 ZZ	6000 2RS	4750	1960	67,000	40,000	0.019
12	28	8	6001	6001 ZZ	6001 2RS	5400	2360	60,000	38,000	0.021
15	32	9	6002	6002 ZZ	6002 2RS	5850	2850	50,000	32,000	0.030
17	35	10	6003	6003 ZZ	6003 2RS	6370	3250	45,000	28,000	0.038
20	42	12	6004	6004 ZZ	6004 2RS	9950	5000	38,000	24,000	0.067
25	47	12	6005	6005 ZZ	6005 2RS	11900	6550	32,000	20,000	0.078
30	55	13	6006	6006 ZZ	6006 2RS	13800	8300	28,000	17,000	0.120
35	62	14	6007	6007 ZZ	6007 2RS	16800	10200	24,000	15,000	0.150
40	68	15	6008	6008 ZZ	6008 2RS	17800	11000	22,000	14,000	0.190
45	75	16	6009	6009 ZZ	6009 2RS	22100	14600	20,000	12,000	0.240
50	80	16	6010	6010 ZZ	6010 2RS	22900	16000	18,000	11,000	0.260
55	90	18	6011	6011 ZZ	6011 2RS	29600	21200	16,000	10,000	0.390
60	95	18	6012	6012 ZZ	6012 2RS	30700	23200	15,000	9,500	0.410
65	100	18	6013	6013 ZZ	6013 2RS	31900	25000	14,000	9,000	0.440
70	110	20	6014	6014 ZZ	6014 2RS	39700	31000	13,000	8,000	0.610
75	115	20	6015	6015 ZZ	6015 2RS	41600	33500	12,000	7,500	0.650

Single Row Series: 6000

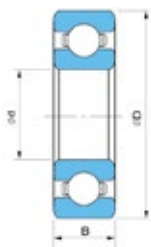

Principal dimensions			Designation			Basic Load Ratings		Speed Ratings		Mass	
d	D	B				Dynamic	Static	Reference speed	Limiting speed		kg
mm						C	C ₀				
						N		r/min			
80	125	22	6016	6016 ZZ	6016 2RS	49400	40000	11,000	7,000	0.870	
85	130	22	6017	6017 ZZ	6017 2RS	52000	43000	11,000	6,700	0.920	
90	140	24	6018	6018 ZZ	6018 2RS	60500	50000	10,000	6,300	1.15	
95	145	24	6019	6019 ZZ	6019 2RS	63700	54000	9,500	6,000	1.10	
100	150	24	6020	6020 ZZ	6020 2RS	63700	54000	9,500	5,600	1.25	
105	160	26	6021	6021 ZZ	6021 2RS	76100	65500	8,500	5,300	1.60	
110	170	28	6022	6022 ZZ	6022 2RS	85200	73500	8,000	5,000	1.95	
120	180	28	6024	6024 ZZ	6024 2RS	88400	80000	7,500	4,800	2.10	
130	200	33	6026	6026 ZZ	6026 2RS	112000	100000	7,000	4,300	3.25	
140	210	33	6028	6028 ZZ	6028 2RS	111000	108000	6,700	4,000	3.45	
150	225	35	6030	6030 ZZ	6030 2RS	125000	125000	6,000	3,800	4.30	
160	240	38	6032	6032 ZZ	6032 2RS	143000	143000	5,600	3,600	5.20	
170	260	42	6034	6034 ZZ	6034 2RS	168000	173000	5,300	3,200	7.00	
180	280	46	6036	6036 ZZ	6036 2RS	190000	200000	4,800	3,000	9.10	
190	290	46	6038	6038 ZZ	6038 2RS	195000	216000	4,800	3,000	9.55	
200	310	51	6040	6040 ZZ	6040 2RS	216000	245000	4,300	2,800	12.50	
220	340	56	6044	6044 ZZ	6044 2RS	247000	290000	4,000	2,400	16.00	
240	360	56	6048	6048 ZZ	6048 2RS	255000	315000	3,600	2,200	17.00	
260	400	65	6052	6052 ZZ	6052 2RS	291000	375000	3,200	2,000	25.00	
280	420	65	6056	6056 ZZ	6056 2RS	302000	405000	3,000	1,900	26.00	
300	460	74	6060	6060 ZZ	6060 2RS	365000	520000	2,400	1,900	44.50	

Single Row Series: 6200

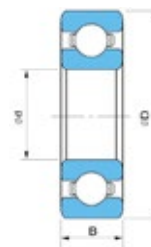

Principal dimensions			Designation			Basic Load Ratings		Speed Ratings		Mass	
d	D	B				Dynamic	Static	Reference speed	Limiting speed		kg
mm						C	C ₀				
						N		r/min			
3	10	4	623	623 ZZ	623 2RS	540	180	130,000	80,000	0.0015	
4	13	5	624	624 ZZ	624 2RS	936	290	110,000	67,000	0.0031	
5	16	5	625	625 ZZ	625 2RS	1140	380	95,000	60,000	0.0050	
6	19	6	626	626 ZZ	626 2RS	2340	950	80,000	50,000	0.0081	
7	22	7	627	627 ZZ	627 2RS	3450	1370	70,000	45,000	0.012	
8	24	8	628	628 ZZ	628 2RS	3900	1660	63,000	40,000	0.018	
9	26	8	629	629 ZZ	629 2RS	4750	1960	60,000	38,000	0.020	
10	30	9	6200	6200 ZZ	6200 2RS	5400	2360	56,000	36,000	0.031	
12	32	10	6201	6201 ZZ	6201 2RS	7280	3100	50,000	32,000	0.037	
15	35	11	6202	6202 ZZ	6202 2RS	8060	3750	43,000	28,000	0.045	
17	40	12	6203	6203 ZZ	6203 2RS	9950	4750	38,000	24,000	0.065	
20	47	14	6204	6204 ZZ	6204 2RS	13500	6550	32,000	20,000	0.110	
22	50	14	62/22	62/22 ZZ	62/22 2RS	14000	7650	30,000	19,000	0.130	
25	52	15	6205	6205 ZZ	6205 2RS	14800	7800	28,000	18,000	0.130	
28	58	16	62/28	62/28 ZZ	62/28 2RS	16800	9500	26,000	16,000	0.170	
30	62	16	6206	6206 ZZ	6206 2RS	20300	11200	24,000	15,000	0.200	
35	72	17	6207	6207 ZZ	6207 2RS	27000	15300	20,000	13,000	0.290	
40	80	18	6208	6208 ZZ	6208 2RS	32500	19000	18,000	11,000	0.370	
45	85	19	6209	6209 ZZ	6209 2RS	35100	21600	17,000	11,000	0.420	
50	90	20	6210	6210 ZZ	6210 2RS	37100	23200	15,000	10,000	0.450	
55	100	21	6211	6211 ZZ	6211 2RS	46200	29000	14,000	9,000	0.610	
60	110	22	6212	6212 ZZ	6212 2RS	55300	36000	13,000	8,000	0.780	

Single Row Series: 6200

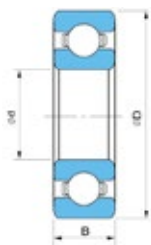

Principal dimensions			Designation			Basic Load Ratings		Speed Ratings		Mass
d	D	B				Dynamic	Static	Reference speed	Limiting speed	
						C	C ₀			
mm						N		r/min		
65	120	23	6213	6213 ZZ	6213 2RS	58500	40500	12,000	7,500	1.00
70	125	24	6214	6214 ZZ	6214 2RS	63700	45000	11,000	7,000	1.10
75	130	25	6215	6215 ZZ	6215 2RS	68900	49000	10,000	6,700	1.20
80	140	26	6216	6216 ZZ	6216 2RS	72800	55000	9,500	6,000	1.45
85	150	28	6217	6217 ZZ	6217 2RS	87100	64000	9,000	5,600	1.80
90	160	30	6218	6218 ZZ	6218 2RS	101000	73500	8,500	5,300	2.20
95	170	32	6219	6219 ZZ	6219 2RS	114000	81500	8,000	5,000	2.65
100	180	34	6220	6220 ZZ	6220 2RS	127000	93000	7,500	4,800	3.15
105	190	36	6221	6221 ZZ	6221 2RS	140000	104000	7,000	4,500	3.80
110	200	38	6222	6222 ZZ	6222 2RS	151000	118000	6,700	4,300	4.45
120	215	40	6224	6224 ZZ	6224 2RS	146000	118000	6,300	4,000	5.25
130	230	40	6226	6226 ZZ	6226 2RS	156000	132000	5,600	3,600	5.85
140	250	42	6228	6228 ZZ	6228 2RS	165000	150000	5,300	3,400	7.75
150	270	45	6230	6230 ZZ	6230 2RS	174000	166000	5,000	3,200	10
160	290	48	6232	6232 ZZ	6232 2RS	186000	186000	4,500	3,000	13
170	310	52	6234	6234 ZZ	6234 2RS	212000	224000	4,300	2,800	16
180	320	52	6236	6236 ZZ	6236 2RS	229000	240000	4,000	2,600	42
190	340	55	6238	6238 ZZ	6238 2RS	255000	280000	3,800	2,400	20
200	360	58	6240	6240 ZZ	6240 2RS	270000	310000	3,600	2,200	24
220	400	65	6244	6244 ZZ	6244 2RS	296000	365000	3,200	2,000	34
300	540	85	6260	6260 ZZ	6260 2RS	462000	670000	2,400	2,000	89

Single Row Series: 6300

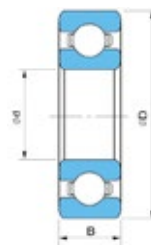

Principal dimensions			Designation			Basic Load Ratings		Speed Ratings		Mass
d	D	B				Dynamic	Static	Reference speed	Limiting speed	
						C	C ₀			
mm						N		r/min		
4	16	5	634	634 ZZ	634 2RS	1110	380	95,000	60,000	0.0054
5	19	6	635	635 ZZ	635 2RS	2340	950	80,000	50,000	0.0085
6	22	7	636	636 ZZ	636 2RS	2970	1224	40,800	30,600	0.013
7	26	9	637	637 ZZ	637 2RS	3600	1422	36,000	27,000	0.024
8	28	9	638	638 ZZ	638 2RS	4095	1773	33,600	25,200	0.027
9	30	10	639	639 ZZ	639 2RS	4590	2151	31,200	23,400	0.034
10	35	11	6300	6300 ZZ	6300 2RS	8520	3400	50,000	32,000	0.053
12	37	12	6301	6301 ZZ	6301 2RS	10100	4150	45,000	28,000	0.060
15	42	13	6302	6302 ZZ	6302 2RS	11900	5400	38,000	24,000	0.082
17	47	14	6303	6303 ZZ	6303 2RS	14300	6550	34,000	22,000	0.11
20	52	15	6304	6304 ZZ	6304 2RS	16800	7800	30,000	19,000	0.14
22	56	16	63/22	63/22 ZZ	63/22 2RS	18600	9300	28,000	18,000	0.18
25	62	17	6305	6305 ZZ	6305 2RS	23400	11600	24,000	16,000	0.23
28	68	18	63/28	63/28 ZZ	63/28 2RS	25100	13700	22,000	14,000	0.30
30	72	19	6306	6306 ZZ	6306 2RS	29600	16000	20,000	13,000	0.35
35	80	21	6307	6307 ZZ	6307 2RS	35100	19000	19,000	12,000	0.46
40	90	23	6308	6308 ZZ	6308 2RS	42300	24000	17,000	11,000	0.63
45	100	25	6309	6309 ZZ	6309 2RS	55300	31500	15,000	9,500	0.84
50	110	27	6310	6310 ZZ	6310 2RS	65000	38000	13,000	8,500	1.10
55	120	29	6311	6311 ZZ	6311 2RS	74100	45000	12,000	8,000	1.35

Single Row Series: 6300

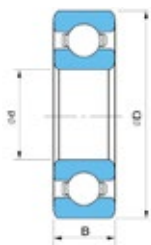

Principal dimensions			Designation			Basic Load Ratings		Speed Ratings		Mass
d	D	B				Dynamic	Static	Reference speed	Limiting speed	
mm						C	C ₀	r/min	r/min	
						N				
60	130	31	6312	6312 ZZ	6312 2RS	85200	52000	11,000	7,000	1.70
65	140	33	6313	6313 ZZ	6313 2RS	97500	60000	10,000	6,700	2.10
70	150	35	6314	6314 ZZ	6314 2RS	111000	68000	9,500	6,300	2.55
75	160	37	6315	6315 ZZ	6315 2RS	119000	76500	9,000	5,600	3.05
80	170	39	6316	6316 ZZ	6316 2RS	130000	86500	8,500	5,300	3.65
85	180	41	6317	6317 ZZ	6317 2RS	140000	96500	8,000	5,000	4.25
90	190	43	6318	6318 ZZ	6318 2RS	151000	108000	7,500	4,800	4.95
95	200	45	6319	6319 ZZ	6319 2RS	159000	118000	7,000	4,500	5.75
100	215	47	6320	6320 ZZ	6320 2RS	174000	140000	6,700	4,300	7.10
105	225	49	6321	6321 ZZ	6321 2RS	182000	153000	6,300	4,000	8.15
110	240	50	6322	6322 ZZ	6322 2RS	203000	180000	6,000	3,800	9.65
120	260	55	6324	6324 ZZ	6324 2RS	208000	186000	5,600	3,400	12.50
130	280	58	6326	6326 ZZ	6326 2RS	229000	216000	5,000	3,200	15.00
140	300	62	6328	6328 ZZ	6328 2RS	251000	245000	4,800	3,000	18.50
150	320	65	6330	6330 ZZ	6330 2RS	276000	285000	4,300	2,800	23.00
160	340	68	6332	6332 ZZ	6332 2RS	276000	285000	4,000	2,600	26.00
170	360	72	6334	6334 ZZ	6334 2RS	312000	340000	3,800	2,400	31.00
180	380	75	6336	6336 ZZ	6336 2RS	351000	405000	3,600	2,200	36.50
190	400	78	6338	6338 ZZ	6338 2RS	371000	430000	3,400	2,200	42.00

Single Row Heavy Duty Type Series: 6400

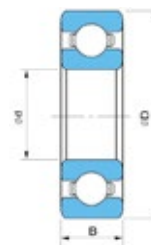

Principal dimensions			Designation			Basic Load Ratings		Speed Ratings		Mass
d	D	B				Dynamic	Static	Reference speed	Limiting speed	
mm						C	C ₀	r/min	r/min	
						N				
17	62	17	6403	6403 ZZ	6403 2RS	22900	10800	28,000	18,000	0.27
20	72	19	6404	6404 ZZ	6404 2RS	30700	15000	24,000	15,000	0.41
25	80	21	6405	6405 ZZ	6405 2RS	35800	19300	20,000	13,000	0.54
30	90	23	6406	6406 ZZ	6406 2RS	43600	23600	18,000	11,000	0.75
35	100	25	6407	6407 ZZ	6407 2RS	55300	31000	16,000	10,000	0.97
40	110	27	6408	6408 ZZ	6408 2RS	63700	36500	14,000	9,000	1.25
45	120	29	6409	6409 ZZ	6409 2RS	76100	45000	13,000	8,500	1.55
50	130	31	6410	6410 ZZ	6410 2RS	87100	52000	12,000	7,500	1.95
55	140	33	6411	6411 ZZ	6411 2RS	99500	62000	11,000	7,000	2.35
60	150	35	6412	6412 ZZ	6412 2RS	108000	69500	10,000	6,300	2.85
65	160	37	6413	6413 ZZ	6413 2RS	119000	78000	9,500	6,000	3.35
70	180	42	6414	6414 ZZ	6414 2RS	143000	104000	8,500	5,300	4.95
75	190	45	6415	6415 ZZ	6415 2RS	153000	114000	8,000	5,000	5.80
80	200	48	6416	6416 ZZ	6416 2RS	163000	125000	7,500	4,800	6.85
85	210	52	6417	6417 ZZ	6417 2RS	174000	137000	7,000	4,500	8.05
90	225	54	6418	6418 ZZ	6418 2RS	186000	150000	6,700	4,300	9.80

Single Row Thin Type Series: 16000

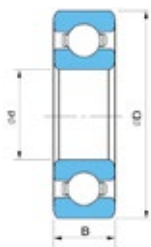

Principal dimensions			Designation			Basic Load Ratings		Speed Ratings		Mass
d	D	B				Dynamic	Static	Reference speed	Limiting speed	
mm						C	C ₀			
						N	r/min	kg		
15	32	8	16002	16002 ZZ	16002 2RS	5850	2850	50,000	32,000	0.030
17	35	8	16003	16003 ZZ	16003 2RS	6370	3250	45,000	28,000	0.038
20	42	8	16004	16004 ZZ	16004 2RS	7280	4050	38,000	24,000	0.050
25	47	8	16005	16005 ZZ	16005 2RS	8060	4750	32,000	20,000	0.060
30	55	9	16006	16006 ZZ	16006 2RS	11900	7350	28,000	17,000	0.089
35	62	9	16007	16007 ZZ	16007 2RS	13000	8150	24,000	15,000	0.11
40	68	9	16008	16008 ZZ	16008 2RS	13800	10200	22,000	14,000	0.13
45	75	10	16009	16009 ZZ	16009 2RS	16500	10800	20,000	12,000	0.17
50	80	10	16010	16010 ZZ	16010 2RS	16800	11400	18,000	11,000	0.18
55	90	11	16011	16011 ZZ	16011 2RS	20300	14000	16,000	10,000	0.27
60	95	11	16012	16012 ZZ	16012 2RS	20800	15000	15,000	9,500	0.29
65	100	11	16013	16013 ZZ	16013 2RS	22500	19600	14,000	9,000	0.30
70	110	13	16014	16014 ZZ	16014 2RS	29100	25000	13,000	8,000	0.44
75	115	13	16015	16015 ZZ	16015 2RS	30200	27000	12,000	7,500	0.46
80	125	14	16016	16016 ZZ	16016 2RS	35100	31500	11,000	7,000	0.61
85	130	14	16017	16017 ZZ	16017 2RS	35800	33500	11,000	6,700	0.64
90	140	16	16018	16018 ZZ	16018 2RS	43600	39000	10,000	6,300	0.85
95	145	16	16019	16019 ZZ	16019 2RS	44900	41500	9,500	6,000	0.89
100	150	16	16020	16020 ZZ	16020 2RS	46200	44000	9,500	5,600	0.94

Single Row Thin Type Series: 16000

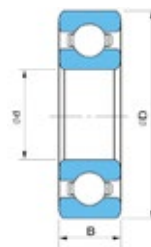

Principal dimensions			Designation			Basic Load Ratings		Speed Ratings		Mass
d	D	B				Dynamic	Static	Reference speed	Limiting speed	
mm						C	C ₀			
						N	r/min	kg		
105	160	18	16021	16021 ZZ	16021 2RS	54000	51000	8,500	5,300	1.20
110	170	19	16022	16022 ZZ	16022 2RS	60500	57000	8,000	5,000	1.45
120	180	19	16024	16024 ZZ	16024 2RS	63700	64000	7,500	4,800	1.55
130	200	22	16026	16026 ZZ	16026 2RS	83200	81500	7,000	4,300	2.35
140	210	22	16028	16028 ZZ	16028 2RS	80600	86500	6,700	4,000	2.55
150	225	24	16030	16030 ZZ	16030 2RS	92300	98000	6,000	3,800	3.15
160	240	25	16032	16032 ZZ	16032 2RS	99500	108000	5,600	3,600	3.65
170	260	28	16034	16034 ZZ	16034 2RS	119000	129000	5,300	3,200	5.00
180	280	31	16036	16036 ZZ	16036 2RS	138000	146000	4,800	3,000	6.50
190	290	31	16038	16038 ZZ	16038 2RS	148000	166000	4,800	3,000	6.90
200	310	34	16040	16040 ZZ	16040 2RS	168000	190000	4,300	2,800	8.80
220	340	37	16044	16044 ZZ	16044 2RS	174000	204000	4,000	2,400	11.50
240	360	37	16048	16048 ZZ	16048 2RS	203000	255000	3,600	2,200	12.50
260	400	44	16052	16052 ZZ	16052 2RS	238000	310000	3,200	2,000	18.00
280	420	44	16056	16056 ZZ	16056 2RS	242000	335000	3,000	1,900	19.00
300	460	50	16060	16060 ZZ	16060 2RS	430000	295000	1,700	2,500	32.60

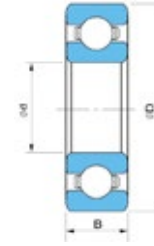
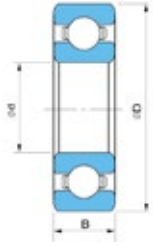

Principal dimensions			Designation			Basic Load Ratings		Speed Ratings		Mass
d	D	B				Dynamic	Static	Reference speed	Limiting speed	
						C	C ₀			
mm						N		r/min		
3	7	2	683	683 ZZ	683 2RS	346	116	81,000	65,000	0.010
4	9	4	684	684 ZZ	684 2RS	585	225	81,000	61,000	0.010
5	11	3	685	685 ZZ	685 2RS	643	255	62,400	46,800	0.012
6	13	5	686	686 ZZ	686 2RS	972	396	57,600	43,200	0.019
7	14	5	687	687 ZZ	687 2RS	1053	459	54,000	40,500	0.002
8	16	5	688	688 ZZ	688 2RS	1125	537	51,600	38,700	0.003
9	17	5	689	689 ZZ	689 2RS	1557	729	49,200	36,900	0.058
10	19	5	6800	6800 ZZ	6800 2RS	1720	830	80,000	48,000	0.005
12	21	5	6801	6801 ZZ	6801 2RS	1740	915	70,000	43,000	0.006
15	24	5	6802	6802 ZZ	6802 2RS	1900	1100	60,000	38,000	0.007
17	26	5	6803	6803 ZZ	6803 2RS	2030	1270	56,000	34,000	0.008
20	32	7	6804	6804 ZZ	6804 2RS	4030	2320	45,000	28,000	0.018
25	37	7	6805	6805 ZZ	6805 2RS	4360	2600	38,000	24,000	0.022
30	42	7	6806	6806 ZZ	6806 2RS	4490	2900	32,000	20,000	0.025
35	47	7	6807	6807 ZZ	6807 2RS	4360	3350	30,000	18,000	0.029
40	52	7	6808	6808 ZZ	6808 2RS	4490	3750	26,000	16,000	0.032
45	58	7	6809	6809 ZZ	6809 2RS	6630	6100	22,000	14,000	0.04
50	65	7	6810	6810 ZZ	6810 2RS	6760	6800	20,000	13,000	0.05
55	72	9	6811	6811 ZZ	6811 2RS	9040	8800	19,000	12,000	0.08
60	78	10	6812	6812 ZZ	6812 2RS	11900	11400	17,000	11,000	0.11
65	85	10	6813	6813 ZZ	6813 2RS	12400	12700	16,000	10,000	0.13
70	90	10	6814	6814 ZZ	6814 2RS	12400	13200	15,000	9,000	0.14
75	95	10	6815	6815 ZZ	6815 2RS	12700	14300	14,000	8,500	0.15
80	100	10	6816	6816 ZZ	6816 2RS	13000	15000	13,000	8,000	0.15
85	110	13	6817	6817 ZZ	6817 2RS	19500	20800	12,000	7,500	0.27

Principal dimensions			Designation			Basic Load Ratings		Speed Ratings		Mass
d	D	B				Dynamic	Static	Reference speed	Limiting speed	
						C	C ₀			
mm						N		r/min		
90	115	13	6818	6818 ZZ	6818 2RS	19500	22000	11,000	7,000	0.28
95	120	13	6819	6819 ZZ	6819 2RS	19900	22800	11,000	6,700	0.30
100	125	13	6820	6820 ZZ	6820 2RS	17800	18300	10,000	6,300	0.31
105	130	13	6821	6821 ZZ	6821 2RS	20800	19600	10,000	6,300	0.32
110	140	16	6822	6822 ZZ	6822 2RS	28100	26000	9,500	5,600	0.49
120	150	16	6824	6824 ZZ	6824 2RS	29100	28000	8,500	5,300	0.54
130	165	18	6826	6826 ZZ	6826 2RS	37700	43000	8,000	4,800	0.77
140	175	18	6828	6828 ZZ	6828 2RS	39000	46500	7,500	4,500	0.85
150	190	20	6830	6830 ZZ	6830 2RS	48800	61000	6,700	4,300	1.20
160	200	20	6832	6832 ZZ	6832 2RS	49400	64000	6,300	4,000	1.25
170	215	22	6834	6834 ZZ	6834 2RS	61800	78000	6,000	3,600	1.65
180	225	22	6836	6836 ZZ	6836 2RS	62400	81500	5,600	3,400	1.75
190	240	24	6838	6838 ZZ	6838 2RS	76100	98000	5,300	3,200	2.25
200	250	24	6840	6840 ZZ	6840 2RS	76100	102000	5,000	3,200	2.35
220	270	24	6844	6844 ZZ	6844 2RS	78000	110000	4,500	2,800	2.55
240	300	28	6848	6848 ZZ	6848 2RS	108000	150000	4,000	2,600	3.90
260	320	28	6852	6852 ZZ	6852 2RS	111000	163000	3,800	2,400	4.15
280	350	33	6856	6856 ZZ	6856 2RS	138000	200000	3,400	2,200	6.25
300	380	38	6860	6860 ZZ	6860 2RS	172000	245000	3,200	2,000	8.90
320	400	38	6864	6864 ZZ	6864 2RS	172000	255000	3,000	1,900	9.50
340	420	38	6868	6868 ZZ	6868 2RS	178000	275000	2,800	1,800	10.00
360	440	38	6872	6872 ZZ	6872 2RS	182000	285000	2,600	2,200	12.00
380	480	46	6876	6876 ZZ	6876 2RS	242000	390000	2,400	2,000	20.00
400	500	46	6880	6880 ZZ	6880 2RS	247000	405000	2,400	1,900	20.50



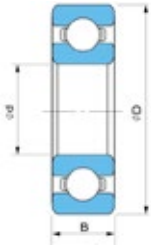

Principal dimensions			Designation			Basic Load Ratings		Speed Ratings		Mass
d	D	B				Dynamic	Static	Reference speed	Limiting speed	
mm						C	C ₀			
						N		r/min		
3	8	4	693	693 ZZ	693 2RS	504	161	80,000	60,000	0.0008
4	11	4	694	694 ZZ	694 2RS	820	275	82,000	50,000	0.0017
5	13	4	695	695 ZZ	695 2RS	972	387	60,000	45,000	0.0025
6	15	5	696	696 ZZ	696 2RS	1566	603	56,400	42,300	0.0039
7	17	5	697	697 ZZ	697 2RS	1449	643	50,400	37,800	0.0049
8	19	6	698	698 ZZ	698 2RS	2016	814	52,000	39,000	0.0071
9	20	6	699	699 ZZ	699 2RS	1908	886	48,000	36,000	0.0076
10	22	6	6900	6900 ZZ	6900 2RS	2700	1270	70,000	45,000	0.010
12	24	6	6901	6901 ZZ	6901 2RS	2910	1460	67,000	40,000	0.011
15	28	7	6902	6902 ZZ	6902 2RS	4360	2240	56,000	34,000	0.016
17	30	7	6903	6903 ZZ	6903 2RS	4620	2550	50,000	32,000	0.016
20	37	9	6904	6904 ZZ	6904 2RS	6370	3650	43,000	26,000	0.037
25	42	9	6905	6905 ZZ	6905 2RS	7020	4300	36,000	22,000	0.045
30	47	9	6906	6906 ZZ	6906 2RS	7280	4550	30,000	19,000	0.049
35	55	10	6907	6907 ZZ	6907 2RS	10800	7800	26,000	16,000	0.080
40	62	12	6908	6908 ZZ	6908 2RS	13800	10000	24,000	14,000	0.12
45	68	12	6909	6909 ZZ	6909 2RS	14000	10800	20,000	13,000	0.14
50	72	12	6910	6910 ZZ	6910 2RS	14600	11800	19,000	12,000	0.14
55	80	13	6911	6911 ZZ	6911 2RS	16500	14000	17,000	11,000	0.19
60	85	13	6912	6912 ZZ	6912 2RS	16500	14300	16,000	10,000	0.20
65	90	13	6913	6913 ZZ	6913 2RS	17400	16000	15,000	9,500	0.22
70	100	16	6914	6914 ZZ	6914 2RS	23800	21200	14,000	8,500	0.35
75	105	16	6915	6915 ZZ	6915 2RS	24200	22400	13,000	8,000	0.37
80	110	16	6916	6916 ZZ	6916 2RS	25100	20400	12,000	7,500	0.38

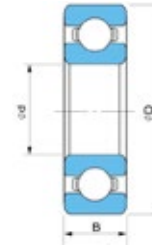

Principal dimensions			Designation			Basic Load Ratings		Speed Ratings		Mass
d	D	B				Dynamic	Static	Reference speed	Limiting speed	
mm						C	C ₀			
						N		r/min		
85	120	18	6917	6917 ZZ	6917 2RS	31900	30000	11,000	7,000	0.55
90	125	18	6918	6918 ZZ	6918 2RS	33200	31500	11,000	6,700	0.59
95	130	18	6919	6919 ZZ	6919 2RS	33800	33500	10,000	6,300	0.61
100	140	20	6920	6920 ZZ	6920 2RS	42300	41500	9,500	6,000	0.83
105	145	20	6921	6921 ZZ	6921 2RS	44200	44000	9,500	5,600	0.87
110	150	20	6922	6922 ZZ	6922 2RS	43600	45000	9,000	5,600	0.90
120	165	22	6924	6924 ZZ	6924 2RS	55300	57000	8,000	5,000	1.20
130	180	24	6926	6926 ZZ	6926 2RS	65000	67000	7,500	4,500	1.60
140	190	24	6928	6928 ZZ	6928 2RS	66300	72000	7,000	4,300	1.70
150	210	28	6930	6930 ZZ	6930 2RS	88400	93000	6,300	5,300	3.05
160	220	28	6932	6932 ZZ	6932 2RS	92300	98000	6,000	3,800	2.70
170	230	28	6934	6934 ZZ	6934 2RS	93600	106000	5,600	4,800	3.40
180	250	33	6936	6936 ZZ	6936 2RS	119000	134000	5,300	3,200	5.00
190	260	33	6938	6938 ZZ	6938 2RS	117000	134000	5,000	3,200	4.50
200	280	38	6940	6940 ZZ	6940 2RS	148000	166000	4,800	3,000	6.30
220	300	38	6944	6944 ZZ	6944 2RS	151000	180000	4,300	2,600	6.80
240	320	38	6948	6948 ZZ	6948 2RS	159000	200000	4,000	2,400	7.30
260	360	46	6952	6952 ZZ	6952 2RS	212000	270000	3,600	2,200	12.00
280	380	46	6956	6956 ZZ	6956 2RS	216000	285000	3,200	2,000	12.00
300	420	56	6960	6960 ZZ	6960 2RS	270000	375000	3,000	1,900	19.00
360	480	56	6972	6972 ZZ	6972 2RS	291000	450000	2,600	2,000	28.00
380	520	65	6976	6976 ZZ	6976 2RS	338000	540000	2,400	1,900	40.00
400	540	65	6980	6980 ZZ	6980 2RS	345000	570000	2,200	1,800	41.50



Single Row Series: 62200

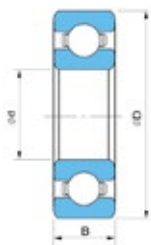

Principal dimensions			Designation			Basic Load Ratings		Speed Ratings		Mass
d	D	B				Dynamic	Static	Reference speed	Limiting speed	
mm						C	C ₀	r/min	r/min	
						N			kg	
10	30	14	62200	62200 ZZ	62200 2RS	5070	2360	–	17,000	0.040
12	32	14	62201	62201 ZZ	62201 2RS	6890	3100	–	15,000	0.045
15	35	14	62202	62202 ZZ	62202 2RS	7800	3750	–	13,000	0.054
17	40	16	62203	62203 ZZ	62203 2RS	9560	4750	–	12,000	0.089
20	47	18	62204	62204 ZZ	62204 2RS	12700	6550	–	10,000	0.13
25	52	18	62205	62205 ZZ	62205 2RS	14000	7800	–	8,500	0.15
30	62	20	62206	62206 ZZ	62206 2RS	19500	11200	–	7,500	0.25
35	72	23	62207	62207 ZZ	62207 2RS	25500	15300	–	6,300	0.40
40	80	23	62208	62208 ZZ	62208 2RS	30700	19000	–	5,600	0.47
45	85	23	62209	62209 ZZ	62209 2RS	33200	21600	–	5,000	0.51
50	90	23	62210	62210 ZZ	62210 2RS	35100	23200	–	4,800	0.54
55	100	25	62211	62211 ZZ	62211 2RS	43600	29000	–	4,300	0.75
60	110	28	62212	62212 ZZ	62212 2RS	52700	36000	–	4,000	1.00
65	120	31	62213	62213 ZZ	62213 2RS	55900	40500	–	3,600	1.40
70	125	31	62214	62214 ZZ	62214 2RS	60500	45000	–	3,400	1.40

Single Row Series: 62300

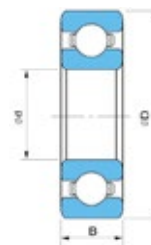

Principal dimensions			Designation			Basic Load Ratings		Speed Ratings		Mass
d	D	B				Dynamic	Static	Reference speed	Limiting speed	
mm						C	C ₀	r/min	r/min	
						N			kg	
10	35	17	62300	62300 ZZ	62300 2RS	8060	3400	–	15,000	0.06
15	42	17	62302	62302 ZZ	62302 2RS	11400	5400	–	12,000	0.11
17	47	19	62303	62303 ZZ	62303 2RS	13500	6550	–	11,000	0.16
20	52	21	62304	62304 ZZ	62304 2RS	15900	7800	–	9,500	0.21
25	62	24	62305	62305 ZZ	62305 2RS	22500	11600	–	7,500	0.32
30	72	27	62306	62306 ZZ	62306 2RS	28100	16000	–	6,300	0.50
35	80	31	62307	62307 ZZ	62307 2RS	33200	19000	–	6,000	0.68
40	90	33	62308	62308 ZZ	62308 2RS	41000	24000	–	5,000	0.92
45	100	36	62309	62309 ZZ	62309 2RS	52700	31500	–	4,500	1.20
50	110	40	62310	62310 ZZ	62310 2RS	61800	38000	–	4,300	1.60
55	120	43	62311	62311 ZZ	62311 2RS	71500	45000	–	3,800	2.05
60	130	46	62312	62312 ZZ	62312 2RS	81900	52000	–	3,400	2.55
65	140	48	62313	62313 ZZ	62313 2RS	92300	60000	–	3,200	3.00
70	150	51	62314	62314 ZZ	62314 2RS	104000	68000	–	3,000	3.75

Single Row Series: 63000

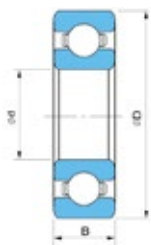

Principal dimensions			Designation			Basic Load Ratings		Speed Ratings		Mass
d	D	B				Dynamic	Static	Reference speed	Limiting speed	
mm						C	C ₀			
						N		r/min		
10	26	12	63000	63000 ZZ	63000 2RS	4620	1960	–	19,000	0.03
12	28	12	63001	63001 ZZ	63001 2RS	5070	2360	–	17,000	0.03
15	32	13	63002	63002 ZZ	63002 2RS	5590	2850	–	14,000	0.04
17	35	14	63003	63003 ZZ	63003 2RS	6050	3250	–	13,000	0.05
20	42	16	63004	63004 ZZ	63004 2RS	9360	5000	–	11,000	0.09
25	47	16	63005	63005 ZZ	63005 2RS	11200	6550	–	9,500	0.11
30	55	19	63006	63006 ZZ	63006 2RS	13300	8300	–	8,000	0.17
35	62	20	63007	63007 ZZ	63007 2RS	15900	10200	–	7,000	0.23
40	68	21	63008	63008 ZZ	63008 2RS	16800	11000	–	6,300	0.27

Industrial Ball Bearings Inch Type Series: 1600

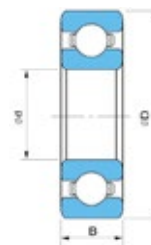

Principal dimensions				Designation			Basic Load Ratings		Mass
d		D	B				Dynamic	Static	
in.	Fraction	in.					C	C ₀	
							N		
0.188	3/16	0.688	0.250	1601	1601 ZZ	1601 2RS	2670	980	0.0041
0.250	1/4	0.688	0.250	1602	1602 ZZ	1602 2RS	2830	1070	0.0064
0.313	5/16	0.875	0.281	1603	1603 ZZ	1603 2RS	3320	1380	0.0095
0.375	3/8	0.875	0.281	1604	1604 ZZ	1604 2RS	3340	1425	0.0086
0.313	5/16	0.906	0.313	1605	1605 ZZ	1605 2RS	3320	1405	0.0168
0.375	3/8	0.906	0.313	1606	1606 ZZ	1606 2RS	3340	1425	0.0218
0.438	7/16	0.906	0.313	1607	1607 ZZ	1607 2RS	4520	1915	0.0222
0.375	3/8	1.125	0.375	1614	1614 ZZ	1614 2RS	5075	2315	0.0349
0.438	7/16	1.125	0.375	1615	1615 ZZ	1615 2RS	5100	2360	0.0322
0.500	1/2	1.125	0.375	1616	1616 ZZ	1616 2RS	5120	2005	0.0299
0.438	7/16	1.375	0.438	1620	1620 ZZ	1620 2RS	7525	3560	0.0454
0.500	1/2	1.375	0.438	1621	1621 ZZ	1621 2RS	7565	3630	0.0481

Industrial Ball Bearings Inch Type Series: 1600

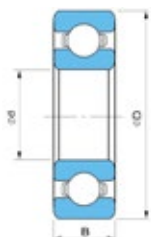

Principal dimensions				Designation			Basic Load Ratings		Mass
d		D	B				Dynamic	Static	
in.	Fraction	in.					C	C ₀	
							N		
0.563	9/16	1.375	0.438	1622	1622 ZZ	1622 2RS	7610	3675	0.0458
0.625	5/8	1.375	0.438	1623	1623 ZZ	1623 2RS	7655	3720	0.0399
0.625	5/8	1.625	0.500	1628	1628 ZZ	1628 2RS	9345	4875	0.0721
0.750	3/4	1.625	0.500	1630	1630 ZZ	1630 2RS	9345	4965	0.0649
0.625	5/8	1.750	0.500	1633	1633 ZZ	1633 2RS	9345	4985	0.0921
0.750	3/4	1.750	0.500	1635	1635 ZZ	1635 2RS	9415	5075	0.0848
0.750	3/4	2.000	0.563	1638	1638 ZZ	1638 2RS	10105	5745	0.1202
0.875	7/8	2.000	0.563	1640	1640 ZZ	1640 2RS	10080	5855	0.1120
1.000	1	2.000	0.563	1641	1641 ZZ	1641 2RS	10060	5990	0.1002
1.125	1 1/8	2.500	0.625	1652	1652 ZZ	1652 2RS	16035	10150	0.2100
1.250	1 1/4	2.500	0.625	1654	1654 ZZ	1654 2RS	16020	10235	0.1901
1.250	1 1/4	2.563	0.688	1657	1657 ZZ	1657 2RS	19580	11125	0.2150
1.313	1 5/16	2.563	0.688	1658	1658 ZZ	1658 2RS	19450	11570	0.2000

Series: R Inch Type

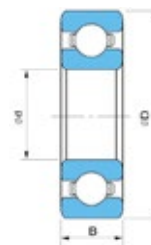

Principal dimensions			Designation			Basic Load Ratings		Speed Ratings		Mass	
d		D				B	Dynamic	Static	Reference speed		Limiting speed
in.	Fraction	in.				C	C ₀	r/min	r/min		
						N		r/min			kg
1.984	6.35	2.38	R 1-4	R 1-4 ZZ	R 1-4 2RS	251	80	53,325	71,100	0.35	
2.38	4.762	1.588	R 133	R 133 ZZ	R 133 2RS	112	38	57,375	76,500	0.12	
2.38	7.938	2.779	R 1-5	R 1-5 ZZ	R 1-5 2RS	387	137	44,550	59,400	0.69	
3.175	6.356	2.38	R 144	R 144 ZZ	R 144 2RS	256	86	47,250	63,000	0.27	
3.175	7.938	2.779	R 2-5	R 2-5 ZZ	R 2-5 2RS	504	162	42,525	56,700	0.61	
3.175	9.525	2.779	R 2-6	R 2-6 ZZ	R 2-6 2RS	576	202	39,150	52,200	0.88	
3.175	9.525	3.967	R - 2	R - 2 ZZ	R - 2 2RS	576	202	39,150	52,200	1.3	
3.175	12.7	4.366	R - 2A	R - 2A ZZ	R - 2A 2RS	1035	355	34,425	45,900	2.5	
3.967	7.938	2.779	R 155	R 155 ZZ	R 155 2RS	301	120	40,500	54,000	0.54	

Series: **R** Inch Type

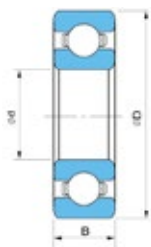

Principal dimensions			Designation			Basic Load Ratings		Speed Ratings		Mass
d	D	B				Dynamic	Static	Reference speed	Limiting speed	
mm						C	C ₀			r/min
						N				
4.762	7.938	2.779	R 156	R 156 ZZ	R 156 2RS	355	129	39,150	52,200	0.44
4.762	9.525	3.175	R 166	R 166 ZZ	R 166 2RS	639	241	37,125	49,500	0.8
4.762	12.7	3.967	R - 3	R - 3 ZZ	R - 3 2RS	1179	441	32,400	43,200	2.2
6.35	9.525	3.175	R 168	R 168 ZZ	R 168 2RS	241	122	34,425	45,900	0.6
6.35	12.7	3.175	R 188	R 188 ZZ	R 188 2RS	747	333	31,050	41,400	1.6
6.35	15.875	4.978	R - 4	R - 4 ZZ	R - 4 2RS	1332	553	29,025	38,700	4.4
6.35	19.05	5.566	R - 4A	R - 4A ZZ	R - 4A 2RS	2016	796	27,000	36,000	7
7.938	12.7	3.967	R 1810	R 1810 ZZ	R 1810 2RS	481	244	32,400	43,200	1.7
9.525	22.225	5.566	R - 6	R - 6 ZZ	R - 6 2RS	3015	1269	25,650	34,200	9

Other types of Miniature and Extra Small Bearings

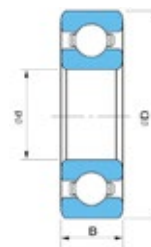

Principal dimensions			Designation	Basic Load Ratings		Speed Ratings	Wt.
d	D	B		Dynamic	Static		
mm				C	C ₀	r/min	gms.
				N			
1.500	4.000	1.200	015M04	101	30	108,000	0.100
1.500	5.000	2.000	015M05	216	62	90,000	0.220
1.500	6.000	2.500	015M06	297	89	81,000	0.350
2.000	5.000	2.000	2M05	169	53	90,000	0.170
2.000	6.000	2.500	2M06	297	89	81,000	0.300
2.000	7.000	2.500	2M07	346	115	67,500	0.450
2.500	8.000	2.500	025M08	504	161	60,300	0.550
3.000	6.000	2.000	3M06	188	66	72,000	0.200
3.000	8.000	2.500	3M08	504	161	60,300	0.500
3.000	9.000	3.000	3M09	576	203	58,500	0.800
4.000	8.000	2.000	4M07	355	126	60,300	0.400
4.000	9.000	2.500	4M08	576	203	54,900	0.650
4.000	11.000	4.000	4M10	643	255	47,700	1.600
5.000	8.000	2.000	5M08	250	118	56,700	0.250
5.000	9.000	2.500	5M09	391	151	54,000	0.550
5.000	10.000	3.000	5M10	391	151	52,200	0.900
7.000	11.000	2.500	7M11	409	181	45,000	0.700
7.000	13.000	3.000	7M13	747	337	43,200	1.500
7.000	14.000	3.500	687	1053	459	40,500	2.000
7.000	17.000	5.000	697	1449	643	37,800	4.800
8.000	12.000	2.200	8M12	481	244	43,200	0.700
8.000	14.000	3.500	8M14	738	346	40,500	1.900
8.000	16.000	4.000	688	1125	531	38,700	3.000
9.000	17.000	4.000	689	1557	729	36,900	5.800

Single Row Flange Type

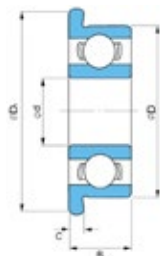

Principal dimensions					Designation	Basic Load Ratings		Speed Ratings	Mass
d	D	D ₁	B	C		Dynamic C	Static C ₀		
mm						N	r/min	gms.	
1.500	4.000	5.000	1.200	0.400	F015M04	101	30	108,000	0.120
1.500	5.000	6.500	2.000	0.600	F015M05	216	62	90,000	0.260
1.500	6.000	7.500	2.500	0.600	F015M06	297	89	81,000	0.420
2.000	5.000	6.100	1.500	0.500	F682	169	53	90,000	0.190
2.000	5.000	6.200	2.000	0.600	F2M05	169	53	90,000	0.210
2.000	6.000	7.500	2.300	0.600	F692	297	89	81,000	0.350
2.000	6.000	7.200	2.500	0.600	F2M06	297	89	81,000	0.360
2.000	7.000	8.200	2.500	0.600	F2M07	346	115	67,500	0.490
2.000	7.000	9.500	2.800	0.700	F602	346	115	67,500	0.600
2.500	6.000	7.100	1.800	0.500	F68/2.5	188	66	72,000	0.250
2.500	7.000	8.500	2.500	0.700	F69/2.5	346	115	67,500	0.500
2.500	8.000	9.200	2.500	0.600	F025M08	504	161	60,300	0.680
2.500	9.000	9.500	2.800	0.700	F60/2.5	495	157	60,300	0.710
3.000	6.000	7.200	2.000	0.600	F3M06	188	66	72,000	0.260
3.000	7.000	8.100	2.000	0.500	F683	346	116	65,700	0.380
3.000	8.000	9.200	2.500	0.600	F3M08	504	161	60,300	0.560
3.000	8.000	9.500	3.000	0.700	F693	504	161	60,300	0.710
3.000	9.000	10.200	2.500	0.600	F3M09	576	203	59,400	0.840
3.000	9.000	10.500	3.000	0.700	F603	576	203	58,500	0.930
3.000	10.000	11.500	4.000	1.000	F623	553	203	49,500	1.650
4.000	7.000	8.200	2.000	0.600	F4M07	283	103	61,200	0.300
4.000	8.000	9.200	2.000	0.600	F4M08	355	126	60,300	0.470
4.000	9.000	10.300	2.500	0.600	F684	576	203	54,900	0.740
4.000	10.000	11.200	3.000	0.600	F4M10	585	212	49,500	1.000
4.000	11.000	12.500	4.000	1.000	F694	643	255	47,700	1.800
4.000	12.000	13.500	4.000	1.000	F604	873	324	42,300	3.100
4.000	13.000	15.000	5.000	1.000	F624	1170	436	40,500	4.100

Single Row Flange Type

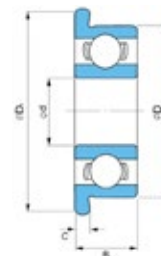

Principal dimensions					Designation	Basic Load Ratings		Speed Ratings	Mass
d	D	D ₁	B	C		Dynamic C	Static C ₀		
mm						N	r/min	gms.	
5.000	8.000	9.200	2.000	0.600	F5M08	250	118	56,700	0.330
5.000	9.000	10.200	2.500	0.600	F5M09	391	151	54,000	0.600
5.000	10.000	11.200	3.000	0.600	F5M10	391	151	52,200	1.000
5.000	11.000	12.500	3.000	0.800	F685	643	255	46,800	1.300
5.000	13.000	15.000	4.000	1.000	F695	972	387	45,000	2.700
5.000	14.000	16.000	5.000	1.000	F605	1197	454	40,500	4.200
5.000	16.000	18.000	5.000	1.000	F625	1557	603	38,700	6.200
6.000	10.000	11.200	2.500	0.600	F6M10	445	197	47,700	0.650
6.000	12.000	13.200	3.000	0.600	F6M12	643	263	45,000	1.500
6.000	13.000	15.000	3.500	1.000	F686	972	396	43,200	2.200
6.000	15.000	17.000	5.000	1.200	F696	1566	603	42,300	4.200
6.000	17.000	19.000	6.000	1.200	F606	2034	756	37,800	6.200
6.000	19.000	22.000	6.000	1.500	F626	2358	954	34,200	8.700
7.000	11.000	12.200	2.500	0.600	F7M11	409	181	45,000	0.800
7.000	13.000	14.200	3.000	0.600	F7M13	747	337	43,200	1.600
7.000	14.000	16.000	3.500	1.000	F687	1053	459	40,500	2.500
7.000	17.000	19.000	5.000	1.200	F697	1449	643	37,800	5.300
7.000	19.000	22.000	6.000	1.500	F607	2358	954	36,000	8.400
8.000	12.000	13.200	2.500	0.600	F8M12	481	244	43,200	0.820
8.000	14.000	15.600	3.500	0.800	F8M14	738	346	40,500	2.100
8.000	16.000	18.000	4.000	1.000	F688	1125	531	38,700	3.400
8.000	19.000	22.000	6.000	1.500	F698	2016	814	37,800	8.200
8.000	22.000	25.000	7.000	1.500	F608	2970	1224	34,200	12.600
9.000	17.000	19.000	4.000	1.000	F689	1557	729	36,900	6.000
9.000	20.000	23.000	6.000	1.500	F699	1908	886	36,000	8.800

Magneto Bearings

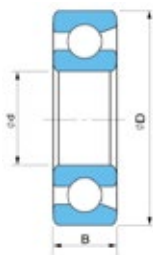

Principal dimensions			Designation	Basic Load Ratings		Speed ratings		Mass
d	D	B		Dynamic	Static	Reference speed	Limiting speed	
mm				C	C_0	Grease	Oil	
				N		r/min		
4	16	5	E4	1550	260	34,000	4,000	0.005
5	16	5	E5	1550	260	34,000	4,000	0.005
6	21	7	E6	2800	450	30,000	36,000	0.011
7	22	7	E7	3100	550	28,000	34,000	0.012
8	24	7	E8	3200	600	28,000	34,000	0.014
9	28	8	E9	4250	830	26,000	32,000	0.022
10	28	8	E10	4250	830	26,000	32,000	0.021
11	32	7	E11	3500	800	22,000	28,000	0.027
12	32	7	E12	3500	800	22,000	28,000	0.027
13	30	7	E13	3500	800	22,000	28,000	0.031

Magneto Bearings

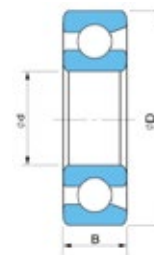

Principal dimensions			Designation	Basic Load Ratings		Speed ratings		Mass
d	D	B		Dynamic	Static	Reference speed	Limiting speed	
mm				C	C_0	Grease	Oil	
				N		r/min		
14	35	8	E14	4500	1100	19,000	24,000	0.034
15	35	8	E15	4500	1100	19,000	24,000	0.043
15	40	10	B015	7350	1700	18,000	22,000	0.055
17	40	10	L17	5700	1450	17,000	2,000	0.053
17	44	11	B017	8800	2100	15,000	18,000	0.073
19	40	9	E19	3450	1000	17,000	2,000	0.048
20	47	12	E20	8800	2240	14,000	17,000	0.087
20	47	14	L20	8800	2240	14,000	17,000	0.1
20	52	15	M20	1220	3000	13,000	16,000	0.138
25	52	15	L25	8650	2400	12,000	15,000	0.122
25	62	17	M25	16000	4000	11,000	14,000	0.217

Double Row Series: 4200

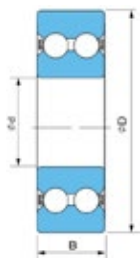

***Note:**
 • Open types bearings are with Steel cage and Close types (2RS and ZZ) are with Nylon/Polyamide cage.

Principal dimensions			Designation			Basic Load Ratings		Speed Ratings		Mass
d	D	B				Dynamic	Static	Reference speed	Limiting speed	
						C	C ₀			
mm						N		r/min		
10	30	14	4200	4200 ZZ	4200 2RS	9230	5200	40,000	22,000	0.049
12	32	14	4201	4201 ZZ	4201 2RS	10600	6200	36,000	20,000	0.052
15	35	14	4202	4202 ZZ	4202 2RS	11900	7500	32,000	17,000	0.059
17	40	16	4203	4203 ZZ	4203 2RS	14800	9500	28,000	15,000	0.09
20	47	18	4204	4204 ZZ	4204 2RS	17800	12500	24,000	13,000	0.14
25	52	18	4205	4205 ZZ	4205 2RS	19000	14600	20,000	11,000	0.17
30	62	20	4206	4206 ZZ	4206 2RS	26000	20800	17,000	9,500	0.29
35	72	23	4207	4207 ZZ	4207 2RS	35100	28500	15,000	8,000	0.40
40	80	23	4208	4208 ZZ	4208 2RS	37100	32500	13,000	7,000	0.50
45	85	23	4209	4209 ZZ	4209 2RS	39000	36000	12,000	6,700	0.54
50	90	23	4210	4210 ZZ	4210 2RS	41000	40000	11,000	6,000	0.58
55	100	25	4211	4211 ZZ	4211 2RS	44900	44000	10,000	5,600	0.80
60	110	28	4212	4212 ZZ	4212 2RS	57200	55000	9,500	5,300	1.10
65	120	31	4213	4213 ZZ	4213 2RS	67600	67000	8,500	4,800	1.45
70	125	31	4214	4214 ZZ	4214 2RS	70200	73500	8,000	4,300	1.50
75	130	31	4215	4215 ZZ	4215 2RS	72800	80000	7,500	4,000	1.60
80	140	33	4216	4216 ZZ	4216 2RS	80600	90000	7,000	3,800	2.00
85	150	36	4217	4217 ZZ	4217 2RS	93600	102000	7,000	3,600	2.55
90	160	40	4218	4218 ZZ	4218 2RS	112000	122000	6,300	3,400	3.20
100	180	46	4220	4220 ZZ	4220 2RS	140000	156000	5,600	3,000	4.70

Double Row Series: 4300

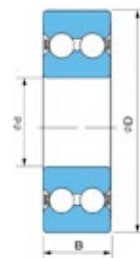

***Note:**
 • Open types bearings are with Steel cage and Close types (2RS and ZZ) are with Nylon/Polyamide cage.

Principal dimensions			Designation			Basic Load Ratings		Speed Ratings		Mass
d	D	B				Dynamic	Static	Reference speed	Limiting speed	
						C	C ₀			
mm						N		r/min		
12	37	17	4301	4301 ZZ	4301 2RS	13000	7800	34,000	18,000	0.092
15	42	17	4302	4302 ZZ	4302 2RS	14800	9500	28,000	15,000	0.12
17	47	19	4303	4303 ZZ	4303 2RS	19500	13200	24,000	13,000	0.16
20	52	21	4304	4304 ZZ	4304 2RS	23400	16000	22,000	12,000	0.21
25	62	24	4305	4305 ZZ	4305 2RS	31900	22400	18,000	10,000	0.34
30	72	27	4306	4306 ZZ	4306 2RS	41000	30000	16,000	8,500	0.50
35	80	31	4307	4307 ZZ	4307 2RS	50700	38000	14,000	7,500	0.68
40	90	33	4308	4308 ZZ	4308 2RS	55900	45000	12,000	6,700	0.95
45	100	36	4309	4309 ZZ	4309 2RS	68900	56000	11,000	6,000	1.25
50	110	40	4310	4310 ZZ	4310 2RS	81900	69500	10,000	5,300	1.70
55	120	43	4311	4311 ZZ	4311 2RS	97500	83000	9,000	5,000	2.15
60	130	46	4312	4312 ZZ	4312 2RS	112000	98000	8,500	4,500	2.65
65	140	48	4313	4313 ZZ	4313 2RS	121000	106000	8,000	4,300	3.25
70	150	51	4314	4314 ZZ	4314 2RS	138000	125000	7,000	3,800	3.95
75	160	55	4315	4315 ZZ	4315 2RS	156000	143000	6,700	3,600	4.80

Self-aligning Ball Bearings



Self-aligning Ball Bearings

The Inner Ring of Self-aligning Bearings has two Raceways, and Outer Ring has one spherical Raceway with its centre at the axis of Bearing. These Bearings have a self-aligning character, hence the name.

These Bearings are suitable for applications where small deflection of shaft may occur in usage.



Self-aligning Ball Bearings

Self-aligning Ball Bearings are

- Capable of carrying radial loads, but they are not suitable for axial loads
- Suitable for low or medium speed applications only

KG can offer following variants

- Open basic design type
- Straight Bore and Tapered Bore type
- Sealed type
- With C2, CN, C3, radial clearance
- With extended Inner Ring
- Pressed Steel, machined Brass or Nylon Cage

KG also offers as a set, Tapered Bore Self-aligning Ball Bearings with Adapter Sleeves.



Self-aligning Ball Bearings

KG standard suffixes for Self-aligning Ball Bearings

C2	Radial internal clearance less than normal.
CN	Normal radial internal clearance. Generally, no special suffix is used in KG Bearings for normal radial internal clearance.
C3	Radial internal clearance higher than normal.
G1-G15	KG internal grease type codes. For details, please contact KG International FZCO.
K	Tapered Bore, with taper of 1:12.
M	Machined Brass Cage.
P or TN	Plastic / Polyamide / Nylon Cage.
P5	Dimensional and running accuracy confirming to ISO class 5.
Q1-Q1	KG internal reference codes. For details please contact KG International FZCO.
RS	Rubber Seal with Steel sheet reinforcement on one sides of the Bearing.
2RS	Rubber Seal with Steel sheet reinforcement on both sides of the Bearing.

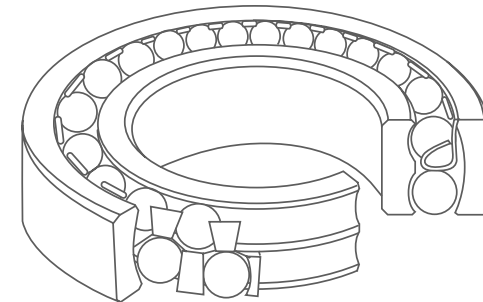

Note: Most of the Bearings listed in the following pages of this chapter are available with above suffixes, subject to design or manufacturing constraints.



Double Row Series: 12

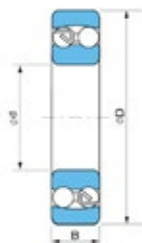

Principal dimensions			Designation	Basic Load Ratings		Speed ratings		Mass
d	D	B		Dynamic	Static	Reference speed	Limiting speed	
mm				C	C ₀	Grease	Oil	
				N		r/min		
5	19	6	125	2510	480	63,000	45,000	0.009
6	19	6	126	2510	480	70,000	45,000	0.009
7	22	7	127	2650	560	63,000	40,000	0.014
8	22	7	108	2650	560	60,000	40,000	0.014
10	30	9	1200	5530	1180	56,000	36,000	0.034
12	32	10	1201	6240	1430	50,000	32,000	0.040
15	35	11	1202	7410	1760	45,000	28,000	0.049
17	40	12	1203	8840	2200	38,000	24,000	0.073
20	47	14	1204	12700	3400	32,000	20,000	0.120
25	52	15	1205	14300	4000	28,000	18,000	0.140
30	62	16	1206	15600	4650	24,000	15,000	0.220
35	72	17	1207	19000	6000	20,000	13,000	0.320
40	80	18	1208	19900	6950	18,000	11,000	0.420
45	85	19	1209	22900	7800	17,000	11,000	0.470
50	90	20	1210	26500	9150	16,000	10,000	0.530
55	100	21	1211	27600	10600	14,000	9,000	0.710
60	110	22	1212	31200	12200	12,000	8,500	0.900
65	120	23	1213	35100	14000	11,000	7,000	1.150
70	125	24	1214	35800	14600	11,000	7,000	1.250
75	130	25	1215	39000	15600	10,000	6,700	1.350
80	140	26	1216	39700	17000	9,500	6,000	1.650
85	150	28	1217	48800	20800	9,000	5,600	2.050
90	160	30	1218	57200	23600	8,500	5,300	2.500
95	170	32	1219	63700	27000	8,000	5,000	3.100
100	180	34	1220	68900	30000	7,500	4,800	3.700
110	200	38	1222	88400	39000	6,700	4,300	5.150
120	215	42	1224	119000	53000	6,300	4,000	6.750

Double Row Series: 13

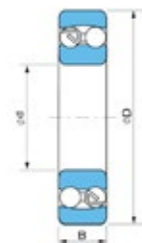

Principal dimensions			Designation	Basic Load Ratings		Speed ratings		Mass
d	D	B		Dynamic	Static	Reference speed	Limiting speed	
mm				C	C ₀	Grease	Oil	
				N		r/min		
12	37	12	1301	9360	2160	40,000	28,000	0.067
15	42	13	1302	10800	2600	34,000	24,000	0.094
17	47	14	1303	12700	3400	28,000	20,000	0.120
20	52	15	1304	14300	4000	26,000	18,000	0.160
25	62	17	1305	19000	5400	22,000	15,000	0.260
30	72	19	1306	22500	6800	19,000	13,000	0.390
35	80	21	1307	26500	8500	16,000	11,000	0.510
40	90	23	1308	33800	11200	14,000	9,500	0.680
45	100	25	1309	39000	13400	12,000	8,500	0.960
50	110	27	1310	43600	14000	12,000	8,000	1.200
55	120	29	1311	50700	18000	11,000	7,500	1.600
60	130	31	1312	58500	22000	9,000	6,300	1.950
65	140	33	1313	65000	25500	8,500	6,000	2.450
70	150	35	1314	74100	27500	8,500	6,000	3.000
75	160	37	1315	79300	30000	8,000	5,600	3.550
80	170	39	1316	88400	33500	7,500	5,300	4.200
85	180	41	1317	97500	38000	7,000	4,800	5.000
90	190	43	1318	117000	44000	6,700	4,500	5.800
95	200	45	1319	133000	51000	6,300	4,300	6.700
100	215	47	1320	143000	57000	6,000	4,000	8.300
110	240	50	1322	163000	72000	5,300	3,600	12.000



Double Row Series: 22

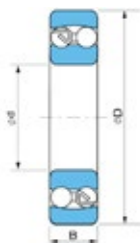

Principal dimensions			Designation		Basic Load Ratings		Speed ratings		Mass
d	D	B			Dynamic	Static	Reference speed	Limiting speed	
mm					C	C ₀	Grease	Oil	
					N		r/min		
10	30	14	2200	2200 2RS	8060	1730	50,000	34,000	0.047
12	32	14	2201	2201 2RS	8520	1900	45,000	30,000	0.053
15	35	14	2202	2202 2RS	8710	2040	38,000	26,000	0.060
17	40	16	2203	2203 2RS	10600	2550	34,000	24,000	0.088
20	47	18	2204	2204 2RS	16800	4150	28,000	20,000	0.140
25	52	18	2205	2205 2RS	16800	4400	26,000	18,000	0.160
30	62	20	2206	2206 2RS	23800	6700	22,000	15,000	0.260
35	72	23	2207	2207 2RS	30200	8800	18,000	12,000	0.400
40	80	23	2208	2208 2RS	31900	10000	16,000	11,000	0.510
45	85	23	2209	2209 2RS	32500	10600	15,000	10,000	0.550
50	90	23	2210	2210 2RS	33800	11200	14,000	9,500	0.600
55	100	25	2211	2211 2RS	39000	13400	12,000	8,500	0.810
60	110	28	2212	2212 2RS	48800	17000	11,000	8,000	1.100
65	120	31	2213	2213 2RS	57200	20000	10,000	7,000	1.450
70	125	31	2214	2214 2RS	44200	17000	10,000	6,700	1.500
75	130	31	2215	2215 2RS	58500	22000	9,000	6,300	1.600
80	140	33	2216	2216 2RS	65000	25500	8,500	6,000	2.000
85	150	36	2217	2217 2RS	58500	23600	8,000	5,600	2.500
90	160	40	2218	2218 2RS	70200	28500	7,500	5,300	3.400
95	170	43	2219	2219 2RS	83200	34500	7,000	5,000	4.100
100	180	46	2220	2220 2RS	97500	40500	6,700	4,800	5.000

Double Row Series: 23

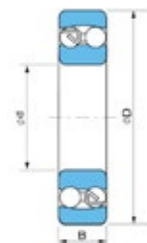

Principal dimensions			Designation		Basic Load Ratings		Speed ratings		Mass
d	D	B			Dynamic	Static	Reference speed	Limiting speed	
mm					C	C ₀	Grease	Oil	
					N		r/min		
10	35	17	2300	2300 2RS	11600	2700	38,000	28,000	0.085
12	37	17	2301	2301 2RS	11700	2700	38,000	28,000	0.095
15	42	17	2302	2302 2RS	11900	2900	32,000	24,000	0.120
17	47	19	2303	2303 2RS	14300	3550	30,000	22,000	0.160
20	52	21	2304	2305 2RS	18200	4750	26,000	19,000	0.220
25	62	24	2305	2304 2RS	27000	7100	22,000	16,000	0.340
30	72	27	2306	2306 2RS	31200	8800	18,000	13,000	0.500
35	80	31	2307	2307 2RS	39700	11200	16,000	12,000	0.680
40	90	33	2308	2308 2RS	54000	16000	14,000	10,000	0.930
45	100	36	2309	2309 2RS	63700	19300	13,000	9,000	1.250
50	110	40	2310	2310 2RS	63700	20000	14,000	9,500	1.650
55	120	43	2311	2311 2RS	76100	24000	11,000	7,500	2.100
60	130	46	2312	2312 2RS	87100	28500	9,500	7,000	2.600
65	140	48	2313	2313 2RS	95600	32500	9,000	6,300	3.250
70	150	51	2314	2314 2RS	111000	37500	8,000	6,000	3.900
75	160	55	2315	2315 2RS	124000	43000	7,500	5,600	4.700
80	170	58	2316	2316 2RS	135000	49000	7,000	5,300	6.100
85	180	60	2317	2317 2RS	140000	51000	6,700	4,800	7.050
90	190	64	2318	2318 2RS	151000	57000	6,300	4,500	8.450
95	200	67	2319	2319 2RS	165000	64000	6,000	4,500	9.800
100	215	73	2320	2320 2RS	190000	80000	5,600	4,000	12.500



Angular contact Ball Bearings (Single and Double Row)



Angular contact Ball Bearings

Angular Contact Ball Bearings are similar to Deep Groove Ball Bearings, however they can sustain combined radial and axial loads, because the line of contact between the Balls and Raceway is at an angle in the radial plane.

There are three standard contact angle classifications for Single Row Angular Contact Ball Bearings. These have been explained under “ Design and Features of Rolling Contact Bearings” section of this handbook.



Angular contact Ball Bearings

Single Row Angular Contact Ball Bearings can also be used as a combination of two or more units as Tandem (TD), Back-to-Back (BTB) or Face-to-Face (FTF) configurations.

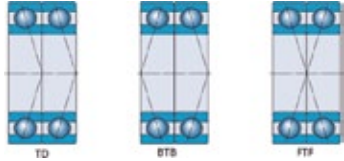

Angular contact Ball Bearings are

- Capable of carrying both axial and radial loads
- Suitable for low, medium and high speed applications

KG can offer following variants

- Open basic design type Single and Double Row Angular Contact Ball Bearings
- As Sealed types
- With Snap Ring groove
- With Snap Ring groove and Snap Ring
- Standard precision grade (ISO Grade 0 -ABEC1) for Single and Double Row Angular Contact Ball Bearings
- Standard as well as higher grade (P6 and P5) for Single Row Angular Contact Ball Bearings used in combination
- Pressed Steel, Nylon Fibre and Brass Cage



Angular contact Ball Bearings

KG standard suffixes for Angular contact Ball Bearings

A	Contact angle of 30 degrees.
B	Contact angle of 40 degrees.
C	Contact angle of 15 degrees.
G1-G15	KG internal grease type codes. For details, please contact KG International FZCO.
M	Machined Brass Cage for open type Bearings.
N	Snap Ring groove in the Outer Ring.
NR	Snap Ring groove in the Outer Ring, with Snap Ring.
TN/P	Nylon Cage for open type Bearings.
P4	Dimensional and running accuracy confirming to ISO class 4.
P5	Dimensional and running accuracy confirming to ISO class 5.
P6	Dimensional and running accuracy confirming to ISO class 6.
Q1-Q8	KG internal reference codes. For details please contact KG International FZCO.
RS	Rubber Seal with Steel sheet reinforcement on one side of the Bearing.
2RS	Rubber Seal with Steel sheet reinforcement on both sides of the Bearing.
Z	Metallic Shield on one side of the Bearing.
ZZ	Metallic Shields on both sides of the Bearing.

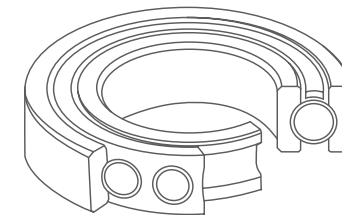

Note: Most of the Bearings listed in the following pages of this chapter are available with above suffixes, subject to design or manufacturing constraints.



Single Row Series: 70

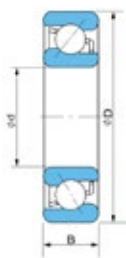

Principal dimensions			Designation		Basic Load Ratings		Speed Ratings		Mass
d	D	B			Dynamic	Static	Reference speed	Limiting speed	
					C	C ₀			
mm					N		r/min		
10	26	8	7000		5000	2340	23,000	31,000	0.022
12	28	8	7001		5050	2710	22,000	29,000	0.024
15	32	9	7002		6150	3400	18,000	24,000	0.035
17	35	10	7003		6400	3800	17,000	22,000	0.045
20	42	12	7004		10300	6050	15,000	20,000	0.079
25	47	12	7005		11300	7400	13,000	17,000	0.091
30	55	13	7006		14500	10100	12,000	14,000	0.135
35	62	14	7007		17500	12600	9,500	13,000	0.170
40	68	15	7008		18800	14500	8,500	11,000	0.210
45	75	16	7009		22200	17600	7,500	10,000	0.265
50	80	16	7010		23600	20000	7,000	9,200	0.285
55	90	18	7011		31000	26200	6,300	8,500	0.420
60	95	18	7012		32000	28000	6,000	7,600	0.450
65	100	18	7013		33500	31000	5,600	7,100	0.470
70	110	20	7014		42500	39500	5,000	6,600	0.660
75	115	20	7015		43500	41500	4,800	6,300	0.695
80	125	22	7016		53500	50500	4,400	5,800	0.925
85	130	22	7017		54500	53500	4,100	5,500	0.960
90	140	24	7018		65000	63000	3,800	5,200	1.260
95	145	24	7019		67000	66500	3,800	5,200	1.360
100	150	24	7020		68500	70500	3,600	4,800	1.370
105	160	26	7021		80000	81500	3,300	4,400	1.730
110	170	28	7022		92000	92500	3,200	4,300	2.140
120	180	28	7024		96500	103000	2,900	3,800	2.270
130	200	33	7026		117000	125000	2,600	3,600	3.430
140	210	33	7028		120000	133000	2,400	3,300	3.630
150	225	35	7030		137000	154000	2,300	3,000	4.420

Single Row Series: 72

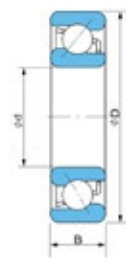

Principal dimensions			Designation		Basic Load Ratings		Speed Ratings		Mass
d	D	B			Dynamic	Static	Reference speed	Limiting speed	
					C	C ₀			
mm					N		r/min		
10	30	9	7200		7020	3350	24,000	30,000	0.0300
12	32	10	7201		7610	3800	20,800	26,000	0.0360
15	35	11	7202		8800	4650	20,800	26,000	0.0450
17	40	12	7203		11000	5850	17,600	22,000	0.0650
20	47	14	7204		14300	8150	15,200	19,000	0.1100
25	52	15	7205		15600	10000	13,600	17,000	0.1300
30	62	16	7206		24000	15600	11,200	14,000	0.2000
35	72	17	7207		31000	20800	9,600	12,000	0.2800
40	80	18	7208		36500	26000	8,800	11,000	0.3700
45	85	19	7209		38000	28500	8,000	10,000	0.4200
50	90	20	7210		40000	31000	7,200	9,000	0.4700
55	100	21	7211		49000	40000	6,400	8,000	0.6200
60	110	22	7212		61000	50000	6,000	7,500	0.8000
65	120	23	7213		69500	57000	5,400	6,700	1.0000
70	125	24	7214		72000	60000	5,000	6,300	1.1000
75	130	25	7215		73500	65500	5,000	6,300	1.2000
80	140	26	7216		85000	75000	4,500	5,600	1.4500
85	150	28	7217		102000	90000	4,300	5,300	1.8500
90	160	30	7218		116000	104000	4,000	5,000	2.3000
95	170	32	7219		124000	108000	3,600	4,500	2.7000
100	180	34	7220		143000	134000	3,600	4,500	3.3000
105	190	36	7221		156000	150000	3,400	4,300	3.9500
110	200	38	7222		163000	156000	3,200	4,000	4.6000
120	215	40	7224		165000	163000	2,900	3,600	5.9000
130	230	40	7226		186000	193000	2,700	3,400	6.9500
140	250	42	7228		199000	212000	2,400	3,000	8.8500
150	270	45	7230		216000	240000	2,200	2,800	11.5000



Single Row Series: 73

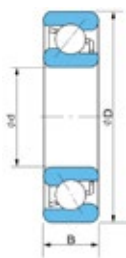

Principal dimensions			Designation	Basic Load Ratings		Speed Ratings		Mass
d	D	B		Dynamic	Static	Reference speed	Limiting speed	
mm				C	C ₀	r/min	r/min	
				N			kg	
12	37	12	7301	10600	5300	19,000	24,000	0.0600
15	42	13	7302	13000	6700	16,000	20,000	0.0800
17	47	14	7303	15900	8300	15,000	19,000	0.1100
20	52	15	7304	19000	10000	14,000	18,000	0.1400
25	62	17	7305	26500	15300	12,000	15,000	0.2300
30	72	19	7306	35500	21200	10,000	13,000	0.3400
35	80	21	7307	41500	26500	9,000	11,000	0.4500
40	90	23	7308	50000	32500	8,000	10,000	0.6800
45	100	25	7309	61000	40500	7,500	9,000	0.9100
50	110	27	7310	75000	51000	6,400	8,000	1.1000
55	120	29	7311	85000	60000	5,600	7,000	1.4000
60	130	31	7312	104000	76500	5,400	6,700	1.7500
65	140	33	7313	116000	86500	5,000	6,300	2.1500
70	150	35	7314	127000	98000	4,500	5,600	2.6500
75	160	37	7315	132000	104000	4,200	5,300	3.2000
80	170	39	7316	143000	118000	4,000	5,000	3.8000
85	180	41	7317	156000	132000	3,800	4,800	4.4500
90	190	43	7318	166000	146000	3,600	4,500	5.2000
95	200	45	7319	180000	163000	3,500	4,300	6.0500
100	215	47	7320	216000	208000	3,200	4,000	7.5000
105	225	49	7321	216000	208000	3,000	3,800	8.5500
110	240	50	7322	240000	245000	2,900	3,600	10.0000
120	260	55	7324	238000	250000	2,400	3,000	14.5000
130	280	58	7326	276000	305000	2,300	2,800	17.0000
140	300	62	7328	302000	345000	2,100	2,600	21.5000
150	320	65	7330	332000	390000	1,900	2,400	26.0000

Single Row Series: 79

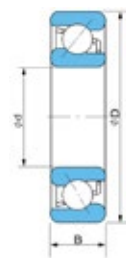

Principal dimensions			Designation	Basic Load Ratings		Speed Ratings		Mass
d	D	B		Dynamic	Static	Reference speed	Limiting speed	
mm				C	C ₀	r/min	r/min	
				N			kg	
10	22	6	7900	3000	1520	48,000	63,000	0.009
12	24	6	7901	3350	1860	45,000	63,000	0.011
15	28	7	7902	4750	2640	38,000	53,000	0.015
17	30	7	7903	5000	2940	34,000	48,000	0.017
20	37	9	7904	6600	4050	24,000	32,000	0.036
25	42	9	7905	7850	5400	24,000	34,000	0.042
30	47	9	7906	8300	6250	22,000	28,000	0.049
35	55	10	7907	12100	9150	18,000	24,000	0.074
40	62	12	7908	15100	11700	16,000	22,000	0.109
45	68	12	7909	16000	13400	14,000	20,000	0.129
50	72	12	7910	16900	15000	13,000	18,000	0.13
55	80	13	7911	19100	17700	12,000	16,000	0.182
60	85	13	7912	19400	18700	11,000	15,000	0.194
65	90	13	7913	20200	20500	10,000	14,000	0.208
70	100	16	7914	28100	27800	9,500	13,000	0.338
75	105	16	7915	28600	29300	9,000	12,000	0.357
80	110	16	7916	29000	30500	8,500	12,000	0.376
85	120	18	7917	39000	40500	8,000	11,000	0.534
90	125	18	7918	41500	46000	7,500	10,000	0.563
95	130	18	7919	42500	48000	7,100	10,000	0.591
100	140	20	7920	50000	54000	6,700	9,000	0.794
105	145	20	7921	51000	57000	6,300	9,000	0.826
110	150	20	7922	52000	59500	6,300	8,500	0.867
120	165	22	7924	72000	81000	5,600	7,500	1.15
130	180	24	7926	78500	91000	5,000	7,100	1.5
140	190	24	7928	79500	95500	4,800	6,700	1.63
150	210	28	7930	102000	122000	4,300	6,000	2.96



Double Row Series: 32

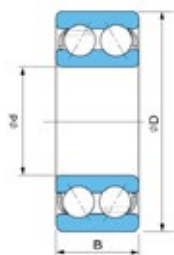

***Note:**
 • Open types bearings are with Steel cage and Close types (2RS and ZZ) are with Nylon/Polyamide cage.

Principal dimensions			Designation			Basic Load Ratings		Speed Ratings		Mass
d	D	B				Dynamic	Static	Reference	Limiting	
mm						C	C ₀	speed	speed	
						N	r/min		kg	
10	30	14	3200	3200 ZZ	3200 2RS	7610	4300	19,000	24,000	0.05100
12	32	15.9	3201	3201 ZZ	3201 2RS	10100	5600	18,000	22,000	0.05800
15	35	15.9	3202	3202 ZZ	3202 2RS	11200	6800	15,000	18,000	0.06600
17	40	17.5	3203	3203 ZZ	3203 2RS	14300	8800	13,000	16,000	0.09600
20	47	20.6	3204	3204 ZZ	3204 2RS	20000	12000	11,300	14,000	0.16000
25	52	20.6	3205	3205 ZZ	3205 2RS	21600	14300	9,600	12,000	0.18000
30	62	23.8	3206	3206 ZZ	3206 2RS	30000	20400	8,000	10,000	0.29000
35	72	27	3207	3207 ZZ	3207 2RS	40000	28000	7,200	9,000	0.44000
40	80	30.2	3208	3208 ZZ	3208 2RS	47500	34000	6,400	8,000	0.57000
45	85	30.2	3209	3209 ZZ	3209 2RS	51000	39000	6,000	7,500	0.63000
50	90	30.2	3210	3210 ZZ	3210 2RS	51000	39000	5,600	7,000	0.65000
55	100	33.3	3211	3211 ZZ	3211 2RS	60000	47500	5,000	6,300	0.91000
60	110	36.5	3212	3212 ZZ	3212 2RS	73500	58500	4,500	5,600	1.20000
65	120	38.1	3213	3213 ZZ	3213 2RS	80600	73500	3,800	4,800	1.75000
70	125	39.7	3214	3214 ZZ	3214 2RS	88400	80000	3,600	4,500	1.90000
75	130	41.3	3215	3215 ZZ	3215 2RS	95600	88000	3,600	4,500	2.10000
80	140	44.4	3216	3216 ZZ	3216 2RS	106000	95000	3,500	4,300	2.65000
85	150	49.2	3217	3217 ZZ	3217 2RS	124000	110000	3,000	3,800	3.40000
90	160	52.4	3218	3218 ZZ	3218 2RS	130000	120000	2,900	3,600	4.15000
95	170	55.6	3219	3219 ZZ	3219 2RS	159000	146000	2,700	3,400	5.00000
100	180	60.3	3220	3220 ZZ	3220 2RS	178000	166000	2,600	3,200	6.10000

Double Row Series: 33

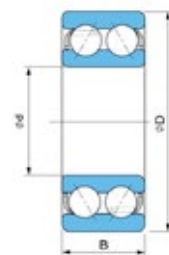

***Note:**
 • Open types bearings are with Steel cage and Close types (2RS and ZZ) are with Nylon/Polyamide cage.

Principal dimensions			Designation			Basic Load Ratings		Speed Ratings		Mass
d	D	B				Dynamic	Static	Reference	Limiting	
mm						C	C ₀	speed	speed	
						N	r/min		kg	
10	32	19	3300	3300 ZZ	3300 2RS	7800	3200	7,500	10,000	0.05800
12	37	19	3301	3301 ZZ	3301 2RS	9000	5100	8,400	12,000	0.06300
15	42	19	3302	3302 ZZ	3302 2RS	15100	9300	13,000	16,000	0.13000
17	47	22.2	3303	3303 ZZ	3303 2RS	21600	12700	11,000	14,000	0.18000
20	52	22.2	3304	3304 ZZ	3304 2RS	23600	14600	10,400	13,000	0.22000
25	62	25.4	3305	3305 ZZ	3305 2RS	32000	20400	8,800	11,000	0.35000
30	72	30.2	3306	3306 ZZ	3306 2RS	41500	27500	7,200	9,000	0.52000
35	80	34.9	3307	3307 ZZ	3307 2RS	52000	35500	6,800	8,500	0.74000
40	90	36.5	3308	3308 ZZ	3308 2RS	64000	44000	6,000	7,500	0.93000
45	100	39.7	3309	3309 ZZ	3309 2RS	75000	53000	5,400	6,700	1.25000
50	110	44.4	3310	3310 ZZ	3310 2RS	90000	64000	4,800	6,000	1.70000
55	120	49.2	3311	3311 ZZ	3311 2RS	112000	81500	4,200	5,300	2.65000
60	130	54	3312	3312 ZZ	3312 2RS	127000	95000	4,000	5,000	2.80000
65	140	58.7	3313	3313 ZZ	3313 2RS	146000	110000	3,600	4,500	4.10000
70	150	63.5	3314	3314 ZZ	3314 2RS	163000	125000	3,500	4,300	5.05000
75	160	68.3	3315	3315 ZZ	3315 2RS	176000	140000	3,200	4,000	5.55000
80	170	68.3	3316	3316 ZZ	3316 2RS	193000	156000	3,000	3,800	6.80000
85	180	73	3317	3317 ZZ	3317 2RS	208000	176000	2,900	3,600	8.30000
90	190	73	3318	3318 ZZ	3318 2RS	208000	180000	2,700	3,400	9.25000
95	200	77.8	3319	3319 ZZ	3319 2RS	240000	216000	2,600	3,200	11.00000
100	215	82.6	3320	3320 ZZ	3320 2RS	255000	255000	2,300	2,800	13.50000



Double Row Series: 52

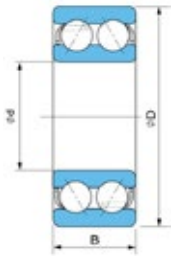

***Note:**

- Open types bearings are with Steel cage and Close types (2RS and ZZ) are with Nylon/Polyamide cage.

Principal dimensions			Designation			Basic Load Ratings		Speed Ratings		Mass
d	D	B				Dynamic	Static	Reference speed	Limiting speed	
mm						C	C ₀	r/min	r/min	
						N			kg	
10	30	14.3	5200	5200 ZZ	5200 2RS	7300	4000	18,000	24,000	0.0500
12	32	15.9	5201	5201 ZZ	5201 2RS	10700	5950	16,000	22,000	0.0600
15	35	15.9	5202	5202 ZZ	5202 2RS	11900	7200	14,000	19,000	0.0700
17	40	17.5	5203	5203 ZZ	5203 2RS	15000	9250	12,000	17,000	0.0900
20	47	20.6	5204	5204 ZZ	5204 2RS	20000	12700	10,000	14,000	0.1200
25	52	20.6	5205	5205 ZZ	5205 2RS	21800	15100	9,500	13,000	0.1900
30	62	23.8	5206	5206 ZZ	5206 2RS	30500	21700	8,000	11,000	0.2900
35	72	27	5207	5207 ZZ	5207 2RS	40000	29500	7,000	9,500	0.4300
40	80	30.2	5208	5208 ZZ	5208 2RS	45500	34000	6,000	8,000	0.5700
45	85	30.2	5209	5209 ZZ	5209 2RS	51000	39000	5,500	7,500	0.6200
50	90	30.2	5210	5210 ZZ	5210 2RS	54500	44500	5,000	6,700	0.6700
55	100	33.3	5211	5211 ZZ	5211 2RS	67500	56500	4,500	6,300	0.9600
60	110	36.5	5212	5212 ZZ	5212 2RS	76000	62000	4,300	5,600	1.3600
65	120	38.1	5213	5213 ZZ	5213 2RS	89000	77000	3,900	5,300	1.6600
70	125	39.7	5214	5214 ZZ	5214 2RS	96500	84500	3,800	5,000	1.8200
75	130	41.3	5215	5215 ZZ	5215 2RS	96000	85500	3,400	4,700	1.9100
80	140	44.4	5216	5216 ZZ	5216 2RS	104000	94000	3,500	4,600	2.4800
85	150	49.2	5217	5217 ZZ	5217 2RS	112000	103000	3,000	4,000	3.4000
90	160	52.4	5218	5218 ZZ	5218 2RS	138000	133000	2,700	3,900	4.2800
95	170	55.6	5219	5219 ZZ	5219 2RS	149000	139000	2,600	3,700	5.0200
100	180	60.3	5220	5220 ZZ	5220 2RS	168000	159000	2,400	3,200	5.7800

Double Row Series: 53

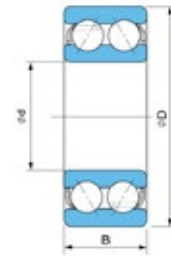

***Note:**

- Open types bearings are with Steel cage and Close types (2RS and ZZ) are with Nylon/Polyamide cage.

Principal dimensions			Designation			Basic Load Ratings		Speed Ratings		Mass
d	D	B				Dynamic	Static	Reference speed	Limiting speed	
mm						C	C ₀	r/min	r/min	
						N			kg	
10	35	19	5300	5300 ZZ	5300 2RS	6500	5700	11,000	15,000	0.0980
12	37	19	5301	5301 ZZ	5301 2RS	7300	6300	10,400	14,000	0.1020
15	42	19	5302	5302 ZZ	5302 2RS	16100	8900	10,000	14,000	0.1020
17	47	22.2	5303	5303 ZZ	5303 2RS	23100	12700	10,000	14,000	0.1400
20	52	22.2	5304	5304 ZZ	5304 2RS	21700	13300	9,000	11,000	0.2300
25	62	25.4	5305	5305 ZZ	5305 2RS	32000	21600	7,300	10,000	0.3400
30	72	30.2	5306	5306 ZZ	5306 2RS	41500	29000	7,000	9,500	0.5100
35	80	34.9	5307	5307 ZZ	5307 2RS	52000	37000	6,300	8,500	0.7900
40	90	36.5	5308	5308 ZZ	5308 2RS	63500	46500	5,500	7,500	1.0500
45	100	39.7	5309	5309 ZZ	5309 2RS	76500	56500	5,000	6,700	1.4200
50	110	44.4	5310	5310 ZZ	5310 2RS	90000	68000	4,500	6,000	1.9300
55	120	49.2	5311	5311 ZZ	5311 2RS	112000	86500	4,000	5,500	2.3000
60	130	54	5312	5312 ZZ	5312 2RS	128000	101000	3,800	5,000	3.1600
65	140	58.7	5313	5313 ZZ	5313 2RS	145000	115000	3,600	4,700	3.8600
70	150	63.5	5314	5314 ZZ	5314 2RS	163000	132000	3,200	4,300	4.8800
75	160	68.3	5315	5315 ZZ	5315 2RS	178000	149000	3,000	4,000	5.5100
80	170	68.3	5316	5316 ZZ	5316 2RS	192000	167000	2,800	4,000	6.8100



Four Point contact Ball Bearings



Four Point contact Ball Bearings

Four-point contact ball bearings are radial single row angular contact ball bearings with raceways are designed to support axial loads in both directions and for a given axial load, a limited radial load can be supported.



Four Point contact Ball Bearings

Four point contact ball bearing consist of solid outer rings, split inner rings and ball and cage assemblies with cages.

Due to the two-piece inner rings, a large number of balls can be accommodated. The halves of the inner ring are matched to the specific bearing and must not be interchanged with another bearings of the same size. The outer ring with the ball and cage assembly can be fitted separately from the halves of the inner ring.

Four Point contact Ball Bearings

KG standard suffixes for Four Point contact Ball Bearings

The standard KG offers four-point contact ball bearings comprise in the QJ 2 and QJ 3 series.

KG offers Four Point Contact Ball Bearings with Brass cage but with Steel and Polyamide cage can be developed as per customer requirements.



Note: Most of the Bearings listed in the following pages of this chapter are available with above suffixes, subject to design or manufacturing constraints.



Series: **QJ 200**

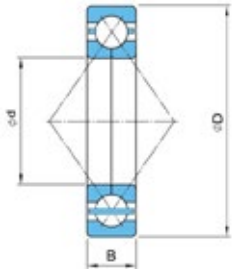

Principal dimensions			Designation	Basic Load Ratings		Speed Ratings		Mass
d	D	B		Dynamic	Static	Reference speed	Limiting speed	
mm				C	C ₀	r/min	r/min	
				N		kg		
15	35	11	QJ 202M	12700	8300	22,000	36,000	0.062
17	40	12	QJ 203M	17000	11400	22,000	30,000	0.082
25	52	15	QJ 205M	27000	21200	16,000	22,000	0.16
30	62	16	QJ 206M	37500	30500	14,000	19,000	0.24
35	72	17	QJ 207M	49000	41500	12,000	17,000	0.35
40	80	18	QJ 208M	56000	49000	11,000	15,000	0.45
45	85	19	QJ 209M	63000	56000	10,000	14,000	0.52
50	90	20	QJ 210M	65500	61000	9,000	13,000	0.59
55	100	21	QJ 211M	85000	83000	8,000	11,000	0.77
60	110	22	QJ 212M	96500	93000	7,500	10,000	0.99
65	120	23	QJ 213M	110000	112000	6,700	9,500	1.20
70	125	24	QJ 214M	120000	122000	6,300	9,000	1.30
75	130	25	QJ 215M	125000	132000	6,300	8,500	1.45
80	140	26	QJ 216M	146000	156000	5,600	8,000	1.85
85	150	28	QJ 217M	156000	173000	5,300	7,500	2.25
90	160	30	QJ 218M	186000	200000	5,000	7,000	2.75
95	170	32	QJ 219M	212000	232000	4,800	6,700	3.35
100	180	34	QJ 220M	236000	265000	4,500	6,300	4.05
110	200	38	QJ 222M	280000	325000	4,000	5,600	5.60
120	215	40	QJ 224M	300000	365000	3,600	5,000	6.95
130	230	40	QJ 226M	310000	400000	3,400	4,800	7.75
140	250	42	QJ 228M	345000	475000	3,200	4,300	9.85
150	270	45	QJ 230M	400000	570000	3,000	4,000	12.50

Series: **QJ 300**

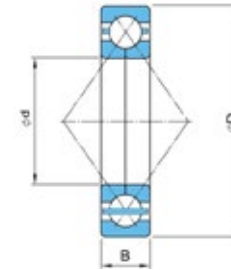

Principal dimensions			Designation	Basic Load Ratings		Speed Ratings		Mass
d	D	B		Dynamic	Static	Reference speed	Limiting speed	
mm				C	C ₀	r/min	r/min	
				N		kg		
17	47	14	QJ 303M	23400	15000	17,000	28,000	0.14
20	52	15	QJ 304M	32000	21600	18,000	24,000	0.18
25	62	17	QJ 305M	42500	30000	15,000	20,000	0.29
30	72	19	QJ 306M	53000	41500	12,000	17,000	0.42
35	80	21	QJ 307M	64000	51000	11,000	15,000	0.57
40	90	23	QJ 308M	78000	64000	10,000	14,000	0.78
45	100	25	QJ 309M	100000	83000	9,000	12,000	1.05
50	110	27	QJ 310M	118000	100000	8,000	11,000	1.35
55	120	29	QJ 311M	137000	118000	7,000	10,000	1.75
60	130	31	QJ 312M	156000	137000	6,700	9,000	2.15
65	140	33	QJ 313M	176000	156000	6,300	8,500	2.70
70	150	35	QJ 314M	200000	180000	5,600	8,000	3.15
75	160	37	QJ 315M	216000	200000	5,300	7,500	3.90
80	170	39	QJ 316M	232000	228000	5,000	7,000	4.60
85	180	41	QJ 317M	250000	255000	4,800	6,700	5.45
90	190	43	QJ 318M	285000	305000	4,500	6,300	6.45
95	200	45	QJ 319M	305000	340000	4,300	6,000	7.45
100	215	47	QJ 320M	345000	400000	4,000	5,600	9.30
110	240	50	QJ 322M	390000	480000	3,600	4,800	12.50
120	260	55	QJ 324M	415000	530000	3,200	4,500	16.00
130	280	58	QJ 326M	455000	610000	3,000	4,000	19.50
140	300	62	QJ 328M	500000	695000	2,800	3,800	24.00
150	320	65	QJ 330M	530000	765000	2,600	3,600	29.00



Cylindrical Roller Bearings (Single and Double Row)



Cylindrical Roller Bearings

As the name implies, these Bearings have Cylindrical Rollers as Rolling Elements. They form a line contact with the Raceway of Inner and Outer Ring. KG Cylindrical Roller Bearings are produced in many variants, and can also be made as per special dimensional requirements, but within some basic design limitations.





Cylindrical Roller Bearings

Cylindrical Roller Bearings are

- Capable of carrying high radial loads but limited axial loads
- Suitable for medium to high load applications
- Suitable for low and medium speed applications
- Suitable for applications requiring good running accuracy at higher radial loads

KG can offer following variants

- Single Row type - N, NF, NJ, NU and NUP
- Double Row type - NN and NNU (details available on request)
- Higher load capacity - E type
- With Snap Ring groove
- With Snap Ring groove and Snap Ring
- With C2, CN and C3 radial clearance
- Standard precision grade P0 and higher precision grade P6 and P5
- Pressed Steel, machined Brass or Steel Cage
- Straight or Taper bore



Cylindrical Roller Bearings

KG standard suffixes for KG Cylindrical Roller Bearings

A	Modified internal design.
C2	Radial internal clearance less than normal.
CN	Normal radial internal clearance. Generally, no special suffix is used in KG Bearings for normal radial internal clearance.
C3	Radial internal clearance higher than normal.
E	Modified design.
K	Tapered Bore, with taper of 1:12.
M	Machined Brass Cage.
N	Snap Ring groove in the Outer Ring.
NR	Snap Ring groove in the Outer Ring, with Snap Ring.
P5	Dimensional and running accuracy confirming to ISO class 5.
P6	Dimensional and running accuracy confirming to ISO class 6.
Q1-Q3	KG internal reference codes. For details please contact KG International FZCO.

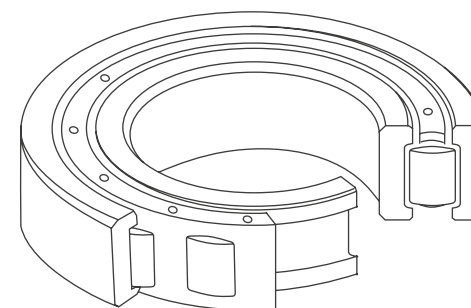

Cylindrical Roller Bearing Design Variants

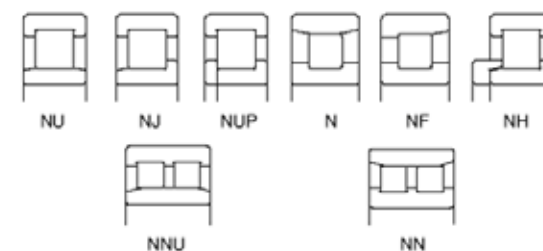

Note: Most of the Bearings listed in the following pages of this chapter are available with above suffixes, subject to design or manufacturing constraints.

Double Row Cylindrical Roller Bearings

Double Row Cylindrical Roller Bearings of series NN.. and NNU.. types are separable radial bearings. And used as non-locating bearings arrangements in combination with reduced internal clearance.

These bearings are having high radial load capacity and are satisfactory for high speed applications, providing a very stiff and rigid bearing arrangements. They are also commonly used with tapered bores with 1:12 taper with suffix K.



Double Row Cylindrical Roller Bearings

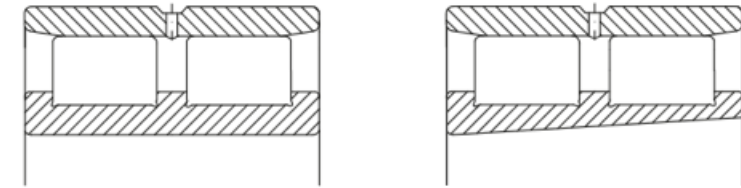

NN TYPE

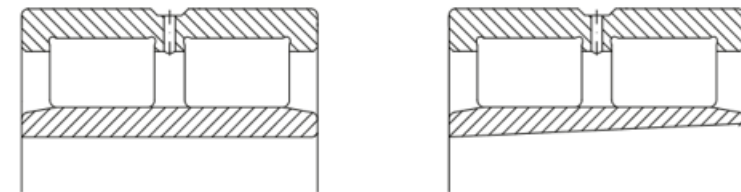

NNU TYPE



Single Row Series: NU/NJ/NUP/N/NF 2



Principal dimensions			Designation						Basic Load Ratings		Speed Ratings		Mass	
d	D	B							Dynamic C	Static C ₀	Reference speed	Limiting speed	kg	
mm									N		r/min		NU	N
20	47	14	NU 204	NJ	NUP	N	NF	—	15400	12700	15,000	18,000	0.112	0.110
20	47	14	NU 204 E	NJ	NUP	—	—	—	25700	22600	15,000	18,000	0.124	—
25	52	15	NU 205	NJ	NUP	N	NF	—	17700	15700	13,000	16,000	0.133	0.130
25	52	15	NU 205 E	NJ	NUP	—	—	—	29300	27700	13,000	16,000	0.140	—
30	62	16	NU 206	NJ	NUP	N	NF	—	23500	21500	11,000	13,000	0.204	0.200
30	62	16	NU 206 E	NJ	NUP	—	—	—	39000	37500	11,000	13,000	0.210	—
35	72	17	NU 207	NJ	NUP	N	NF	—	33500	31500	9,500	11,000	0.295	0.290
35	72	17	NU 207 E	NJ	NUP	—	—	—	50500	50000	9,500	11,000	0.300	—
40	80	18	NU 208	NJ	NUP	N	NF	—	43500	43000	8,500	10,000	0.369	0.360
40	80	18	NU 208 E	NJ	NUP	—	—	—	55500	55500	8,500	10,000	0.380	—
45	85	19	NU 209	NJ	NUP	N	NF	—	46000	47000	7,500	9,000	0.430	0.420
45	85	19	NU 209 E	NJ	NUP	—	—	—	63000	66500	7,500	9,000	0.440	—
50	90	20	NU 210	NJ	NUP	N	NF	—	48000	51000	7,100	8,500	0.481	0.470
50	90	20	NU 210 E	NJ	NUP	—	—	—	69000	76500	7,100	8,500	0.490	—
55	100	21	NU 211	NJ	NUP	N	NF	—	58000	62500	6,300	7,500	0.634	0.630
55	100	21	NU 211 E	NJ	NUP	—	—	—	86500	98500	6,300	7,500	0.670	—
60	110	22	NU 212	NJ	NUP	N	NF	—	68500	75000	6,000	7,100	0.835	0.820

Single Row Series: NU/NJ/NUP/N/NF 2

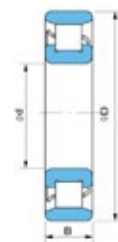

Principal dimensions			Designation						Basic Load Ratings		Speed Ratings		Mass	
d	D	B							Dynamic C	Static C ₀	Reference speed	Limiting speed	kg	
mm									N		r/min		NU	N
60	110	22	NU 212 E	NJ	NUP	—	—	—	97500	107000	6,000	7,100	0.921	—
65	120	23	NU 213	NJ	NUP	N	NF	—	84000	94500	5,300	6,300	1.060	1.040
65	120	23	NU 213 E	NJ	NUP	—	—	—	108000	119000	5,300	6,300	1.180	—
70	125	24	NU 214	NJ	NUP	N	NF	—	83500	95000	5,000	6,300	1.160	1.140
70	125	24	NU 214 E	NJ	NUP	—	—	—	119000	137000	5,000	6,300	1.260	—
75	130	25	NU 215	NJ	NUP	N	NF	—	96500	111000	4,800	6,000	1.240	1.220
75	130	25	NU 215 E	NJ	NUP	—	—	—	130000	156000	4,800	6,000	1.380	—
80	140	26	NU 216	NJ	NUP	N	NF	—	106000	122000	4,500	5,300	1.530	1.500
80	140	26	NU 216 E	NJ	NUP	—	—	—	139000	167000	4,500	5,300	1.660	—
85	150	28	NU 217	NJ	NUP	N	NF	—	120000	140000	4,300	5,000	1.920	1.870
85	150	28	NU 217 E	NJ	NUP	—	—	—	167000	199000	4,300	5,000	2.100	—
90	160	30	NU 218	NJ	NUP	N	NF	—	152000	178000	4,000	4,800	2.300	2.250
90	160	30	NU 218 E	NJ	NUP	—	—	—	182000	217000	4,000	4,800	2.530	—
95	170	32	NU 219	NJ	NUP	N	NF	—	165000	195000	3,800	4,500	2.810	2.750
95	170	32	NU 219 E	NJ	NUP	—	—	—	222000	259000	3,800	4,500	3.080	—
100	180	34	NU 220	NJ	NUP	N	NF	—	183000	217000	3,600	4,300	3.300	3.230
100	180	34	NU 220 E	NJ	NUP	—	—	—	250000	305000	3,600	4,300	3.730	—



Single Row Series: NU/NJ/NUP/N/NF 3

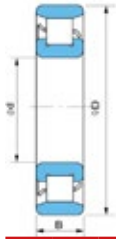

Principal dimensions			Designation						Basic Load Ratings		Speed Ratings		Mass	
d	D	B							Dynamic	Static	Refer-ence speed	Limiting speed		
mm									C	C ₀			r/min	kg
									N					
20	52	15	NU 304	NJ	NUP	N	NF	—	21400	17300	14,000	17,000	0.154	0.150
20	52	15	NU 304 E	NJ	NUP	—	—	—	31500	26900	14,000	17,000	0.150	—
25	62	17	NU 305	NJ	NUP	N	NF	—	29300	25200	11,000	15,000	0.238	0.230
25	62	17	NU 305 E	NJ	NUP	—	—	—	41500	37500	11,000	15,000	0.240	—
30	72	19	NU 306	NJ	NUP	N	NF	—	38500	35000	8,500	11,000	0.357	0.350
30	72	19	NU 306 E	NJ	NUP	—	—	—	53000	50000	8,500	10,000	0.370	—
35	80	21	NU 307	NJ	NUP	N	NF	—	49500	47000	8,000	9,500	0.470	0.460
35	80	21	NU 307 E	NJ	NUP	—	—	—	66500	65500	8,000	9,500	0.490	—
40	90	23	NU 308	NJ	NUP	N	NF	—	58500	57000	6,700	8,500	0.665	0.650
40	90	23	NU 308 E	NJ	NUP	—	—	—	83000	81500	6,700	8,000	0.670	—
45	100	25	NU 309	NJ	NUP	N	NF	—	78500	77500	6,300	7,500	0.871	0.850
45	100	25	NU 309 E	NJ	NUP	—	—	—	97500	98500	6,000	7,500	0.910	—
50	110	27	NU 310	NJ	NUP	N	NF	—	87000	86000	5,600	6,700	1.170	1.140
50	110	27	NU 310 E	NJ	NUP	—	—	—	110000	113000	5,600	6,700	1.170	—
55	120	29	NU 311	NJ	NUP	N	NF	—	111000	111000	5,000	6,300	1.430	1.400
55	120	29	NU 311 E	NJ	NUP	—	—	—	137000	143000	5,000	6,300	1.500	—
60	130	31	NU 312	NJ	NUP	N	NF	—	124000	126000	4,800	5,600	1.820	1.780
60	130	31	NU 312 E	NJ	NUP	—	—	—	150000	157000	4,800	5,600	1.870	—
65	140	33	NU 313	NJ	NUP	N	NF	—	135000	139000	4,500	5,300	2.270	2.220
65	140	33	NU 313 E	NJ	NUP	—	—	—	181000	191000	4,500	5,300	2.550	—
70	150	35	NU 314	NJ	NUP	N	NF	—	158000	220000	4,000	5,000	2.730	2.680
70	150	35	NU 314 E	NJ	NUP	—	—	—	205000	222000	4,000	5,000	3.150	—
75	160	37	NU 315	NJ	NUP	N	NF	—	190000	205000	3,800	4,800	3.210	3.150

Single Row Series: NU/NJ/NUP/N/NF 3

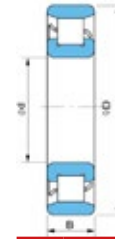

Principal dimensions			Designation						Basic Load Ratings		Speed Ratings		Mass	
d	D	B							Dynamic	Static	Refer-ence speed	Limiting speed		
mm									C	C ₀			r/min	kg
									N					
75	160	37	NU 315 E	NJ	NUP	—	—	—	240000	263000	3,800	4,800	3.700	—
80	170	39	NU 316	NJ	NUP	N	NF	—	190000	207000	3,600	4,300	3.930	3.830
80	170	39	NU 316 E	NJ	NUP	—	—	—	256000	282000	3,600	4,300	4.380	—
85	180	41	NU 317	NJ	NUP	N	NF	—	224000	247000	3,400	4,000	4.540	4.440
85	180	41	NU 317 E	NJ	NUP	—	—	—	291000	330000	3,400	4,000	5.120	—
90	190	43	NU 318	NJ	NUP	N	NF	—	240000	265000	3,200	3,800	5.370	5.250
90	190	43	NU 318 E	NJ	NUP	—	—	—	335000	380000	3,200	3,800	5.920	—
95	200	45	NU 319	NJ	NUP	N	NF	—	259000	289000	3,000	3,600	6.230	6.130
95	200	45	NU 319 E	NJ	NUP	—	—	—	335000	385000	2,600	3,200	6.920	—
100	215	47	NU 320	NJ	NUP	N	NF	—	300000	335000	2,800	3,400	7.700	7.530
100	215	47	NU 320 E	NJ	NUP	—	—	—	380000	425000	2,800	3,400	8.450	—
105	225	49	NU 321	NJ	NUP	N	NF	—	340000	385000	2,600	3,200	8.730	8.510
110	240	50	NU 322	NJ	NUP	N	NF	—	380000	435000	2,600	3,000	10.400	10.200
110	240	50	NU 322 E	NJ	NUP	—	—	—	450000	525000	2,600	3,000	11.100	—
120	260	55	NU 324	NJ	NUP	N	NF	—	450000	510000	2,200	2,800	15.400	15.100
120	260	55	NU 324 E	NJ	NUP	—	—	—	530000	610000	2,200	2,800	15.200	—
130	280	58	NU 326	NJ	NUP	N	NF	—	555000	665000	2,200	2,600	18.200	17.800
130	280	58	NU 326 E	NJ	NUP	—	—	—	615000	735000	2,200	2,600	18.500	—
140	300	62	NU 328	NJ	NUP	N	NF	—	595000	745000	2,000	2,400	22.400	21.800
140	300	62	NU 328 E	NJ	NUP	—	—	—	665000	795000	1,800	2,200	21.800	—
150	320	65	NU 330	NJ	NUP	N	NF	—	660000	805000	1,800	2,200	26.500	25.900
150	320	65	NU 330 E	NJ	NUP	—	—	—	755000	920000	1,800	2,200	28.800	—



Single Row Series: NU/NJ/NUP/N/NF 4

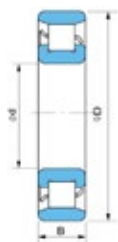

Principal dimensions			Designation							Basic Load Ratings		Speed Ratings		Mass	
d	D	B								Dynamic C	Static C ₀	Reference speed	Limiting speed		
mm										N		r/min		NU	N
25	80	21								NU 405	NJ	NUP	N	NF	—
30	90	23	NU 406	NJ	NUP	N	NF	—	62500	55000	7,500	9,500	0.770	0.750	
35	100	25	NU 407	NJ	NUP	—	NF	—	75500	69000	6,700	8,000	1.050	1.020	
40	110	27	NU 408	NJ	NUP	N	NF	—	95500	89000	6,000	7,500	1.330	1.300	
45	120	29	NU 409	NJ	NUP	N	NF	—	107000	102000	5,600	6,700	1.670	1.640	
50	130	31	NU 410	NJ	NUP	N	NF	—	138000	136000	5,000	6,000	2.050	2.010	
55	140	33	NU 411	NJ	NUP	N	NF	—	139000	138000	4,800	5,600	2.540	2.510	
60	150	35	NU 412	NJ	NUP	N	NF	—	167000	168000	4,300	5,300	3.050	3.020	
65	160	37	NU 413	NJ	NUP	N	NF	—	195000	203000	4,000	4,800	3.680	3.580	
70	180	42	NU 414	NJ	NUP	N	NF	—	228000	236000	3,600	4,300	5.400	5.260	
75	190	45	NU 415	NJ	NUP	N	NF	—	262000	274000	3,400	4,000	6.400	6.250	
80	200	48	NU 416	NJ	NUP	N	NF	—	299000	315000	3,200	3,800	7.450	7.280	
85	210	52	NU 417	NJ	NUP	N	NF	—	330000	350000	3,000	3,800	9.100	8.680	
90	225	54	NU 418	NJ	NUP	N	NF	—	375000	400000	2,800	3,400	10.600	10.300	
95	240	55	NU 419	NJ	NUP	N	NF	—	400000	445000	2,600	3,200	14.000	13.600	
100	250	58	NU 420	NJ	NUP	N	NF	—	450000	500000	2,600	3,000	14.400	14.000	
105	260	60	NU 421	NJ	NUP	N	NF	—	495000	555000	2,400	3,000	19.500	19.100	
110	280	65	NU 422	NJ	NUP	N	NF	—	550000	620000	2,200	2,800	20.500	19.900	
120	310	72	NU 424	NJ	NUP	N	NF	—	675000	770000	2,000	2,400	28.700	28.000	
130	340	78	NU 426	NJ	NUP	N	NF	—	825000	955000	1,800	2,200	36.900	36.100	
140	360	82	NU 428	NJ	NUP	N	NF	—	875000	1020000	1,700	2,000	48.000	46.800	
150	380	85	NU 430	NJ	NUP	N	NF	—	930000	1120000	1,600	2,000	54.500	53.300	

Single Row Series: NU/NJ/NUP 22

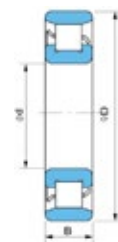

Principal dimensions			Designation							Basic Load Ratings		Speed Ratings		Mass	
d	D	B								Dynamic C	Static C ₀	Reference speed	Limiting speed		
mm										N		r/min		NU	N
25	52	18								NU 2205	NJ	NUP	—	—	—
25	52	18	NU 2205 E	NJ	NUP	—	—	—	35000	34500	12,000	14,000	0.185	—	
30	62	20	NU 2206	NJ	NUP	—	—	—	33000	33000	10,000	12,000	0.262	—	
30	62	20	NU 2206 E	NJ	NUP	—	—	—	49000	50000	10,000	12,000	0.295	—	
35	72	23	NU 2207	NJ	NUP	—	—	—	49000	51000	8,500	10,000	0.402	—	
35	72	23	NU 2207 E	NJ	NUP	—	—	—	61500	65000	8,500	10,000	0.446	—	
40	80	23	NU 2208	NJ	NUP	—	—	—	58000	62000	7,500	9,000	0.490	—	
40	80	23	NU 2208 E	NJ	NUP	—	—	—	72500	77500	7,500	9,000	0.743	—	
45	85	23	NU 2209	NJ	NUP	—	—	—	61500	68000	7,400	8,900	0.536	—	
45	85	23	NU 2209 E	NJ	NUP	—	—	—	76000	84500	7,400	8,900	0.593	—	
105	190	36	NU 221	NJ	NUP	N	NF	—	202000	241000	3,400	4,000	4.030	3.950	
50	90	23	NU 2210	NJ	NUP	—	—	—	64000	73500	6,500	8,000	0.580	—	
50	90	23	NU 2210 E	NJ	NUP	—	—	—	83500	97000	6,400	8,000	0.632	—	
55	100	25	NU 2211	NJ	NUP	—	—	—	75500	87000	6,200	7,400	0.780	—	
55	100	25	NU 2211 E	NJ	NUP	—	—	—	101000	122000	6,200	7,400	0.870	—	
60	110	28	NU 2212	NJ	NUP	—	—	—	96000	116000	5,300	6,300	1.070	—	
60	110	28	NU 2212 E	NJ	NUP	—	—	—	131000	157000	5,300	6,300	1.230	—	
65	120	31	NU 2213	NJ	NUP	—	—	—	120000	149000	4,800	6,000	1.430	—	

Single Row Series: NU/NJ/NUP 22

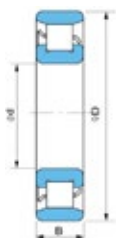

Principal dimensions			Designation						Basic Load Ratings		Speed Ratings		Mass	
d	D	B							Dynamic	Static	Reference speed	Limiting speed	kg	
mm									C	C ₀			r/min	NU
mm									N		r/min		NU	N
65	120	31	NU 2213 E	NJ	NUP	—	—	149000	181000	4,800	6,000	1.650	—	
70	125	31	NU 2214	NJ	NUP	—	—	119000	151000	4,800	5,600	1.520	—	
70	125	31	NU 2214 E	NJ	NUP	—	—	156000	194000	4,600	5,600	1.680	—	
75	130	31	NU 2215	NJ	NUP	—	—	130000	162000	4,500	5,300	1.570	—	
75	130	31	NU 2215 E	NJ	NUP	—	—	162000	207000	4,300	5,300	1.800	—	
80	140	33	NU 2216	NJ	NUP	—	—	147000	186000	4,000	5,000	1.960	—	
80	140	33	NU 2216 E	NJ	NUP	—	—	186000	243000	4,000	5,000	2.150	—	
85	150	36	NU 2217	NJ	NUP	—	—	170000	218000	3,800	4,500	2.500	—	
85	150	36	NU 2217 E	NJ	NUP	—	—	217000	279000	3,800	4,500	2.750	—	
90	160	40	NU 2218	NJ	NUP	—	—	207000	265000	3,600	4,300	3.100	—	
90	160	40	NU 2218 E	NJ	NUP	—	—	242000	315000	3,600	4,300	3.480	—	
95	170	43	NU 2219	NJ	NUP	—	—	230000	298000	3,400	4,000	3.850	—	
95	170	43	NU 2219 E	NJ	NUP	—	—	286000	370000	3,400	4,000	4.230	—	
110	200	38	NU 222	NJ	NUP	N	NF	240000	290000	3,200	3,800	4.640	4.580	
110	200	38	NU 222 E	NJ	NUP	—	—	293000	365000	3,200	3,800	5.170	—	
100	180	46	NU 2220	NJ	NUP	—	—	257000	335000	3,200	3,800	4.670	—	
100	180	46	NU 2220 E	NJ	NUP	—	—	335000	445000	3,200	3,800	5.130	—	

Single Row Series: NU/NJ/NUP 23

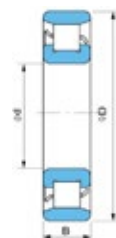

Principal dimensions			Designation						Basic Load Ratings		Speed Ratings		Mass	
d	D	B							Dynamic	Static	Reference speed	Limiting speed	kg	
mm									C	C ₀			r/min	NU
mm									N		r/min		NU	N
20	52	21	NU 2304	NJ	NUP	—	—	30500	27200	14,000	17,000	0.213	—	
20	52	21	NU 2304 E	NJ	NUP	—	—	42000	39000	14,000	17,000	0.240	—	
25	62	24	NU 2305	NJ	NUP	—	—	42500	41000	9,300	11,000	0.340	—	
25	62	24	NU 2305 E	NJ	NUP	—	—	57000	56000	9,000	11,000	0.390	—	
30	72	27	NU 2306	NJ	NUP	—	—	51500	51000	8,200	9,800	0.500	—	
30	72	27	NU 2306 E	NJ	NUP	—	—	74500	77500	8,000	9,500	0.585	—	
35	80	31	NU 2307	NJ	NUP	—	—	60500	60000	7,200	8,600	0.696	—	
35	80	31	NU 2307 E	NJ	NUP	—	—	99000	109000	7,200	8,600	0.780	—	
40	90	33	NU 2308	NJ	NUP	—	—	82500	88000	6,500	7,800	0.956	—	
40	90	33	NU 2308 E	NJ	NUP	—	—	114000	122000	6,500	7,800	1.050	—	
45	100	36	NU 2309	NJ	NUP	—	—	99000	104000	6,100	7,300	1.250	—	
45	100	36	NU 2309 E	NJ	NUP	—	—	137000	153000	6,100	7,300	1.400	—	
50	110	40	NU 2310	NJ	NUP	—	—	121000	131000	5,400	6,500	1.690	—	
50	110	40	NU 2310 E	NJ	NUP	—	—	163000	187000	5,400	6,500	1.850	—	
55	120	43	NU 2311	NJ	NUP	—	—	148000	162000	4,800	5,600	2.100	—	
55	120	43	NU 2311 E	NJ	NUP	—	—	201000	233000	4,800	5,600	2.350	—	
60	130	46	NU 2312	NJ	NUP	—	—	169000	188000	4,300	5,300	2.690	—	
60	130	46	NU 2312 E	NJ	NUP	—	—	222000	262000	4,300	5,300	3.010	—	
65	140	48	NU 2313	NJ	NUP	—	—	188000	212000	4,000	4,800	3.250	—	
65	140	48	NU 2313 E	NJ	NUP	—	—	247000	287000	4,000	4,800	3.560	—	
70	150	51	NU 2314	NJ	NUP	—	—	223000	262000	3,800	4,500	3.970	—	
70	150	51	NU 2314 E	NJ	NUP	—	—	274000	325000	3,800	4,500	4.300	—	
75	160	55	NU 2315	NJ	NUP	—	—	258000	300000	3,400	4,300	4.840	—	



Single Row Series: NU/NJ/NUP 23

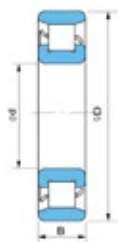

Principal dimensions			Designation						Basic Load Ratings		Speed Ratings		Mass	
d	D	B							Dynamic C	Static C ₀	Reference speed	Limiting speed		
mm									N		r/min		NU	N
75	160	55							NU 2315 E	NJ	NUP	—	—	330000
80	170	58	NU 2316	NJ	NUP	—	—	274000	330000	3,200	4,000	5.830	—	
80	170	58	NU 2316 E	NJ	NUP	—	—	355000	430000	3,200	4,000	6.350	—	
85	180	60	NU 2317	NJ	NUP	—	—	315000	380000	3,000	3,800	6.620	—	
85	180	60	NU 2317 E	NJ	NUP	—	—	390000	485000	3,000	3,800	7.350	—	
90	190	64	NU 2318	NJ	NUP	—	—	325000	395000	2,800	3,600	7.900	—	
90	190	64	NU 2318 E	NJ	NUP	—	—	435000	535000	2,800	3,600	8.720	—	
95	200	67	NU 2319	NJ	NUP	—	—	370000	460000	2,600	3,400	9.390	—	
95	200	67	NU 2319 E	NJ	NUP	—	—	460000	585000	2,600	3,400	10.300	—	
100	215	73	NU 2320	NJ	NUP	—	—	435000	545000	2,400	3,200	11.900	—	
100	215	73	NU 2320 E	NJ	NUP	—	—	570000	715000	2,400	3,200	12.900	—	
110	240	80	NU 2322	NJ	NUP	—	—	570000	735000	2,200	2,800	18.800	—	
110	240	80	NU 2322 E	NJ	NUP	—	—	670000	880000	2,200	2,800	18.500	—	
120	260	86	NU 2324	NJ	NUP	—	—	710000	920000	2,000	2,600	23.100	—	
120	260	86	NU 2324 E	NJ	NUP	—	—	795000	1030000	2,000	2,600	22.900	—	
130	280	93	NU 2326	NJ	NUP	—	—	840000	1130000	1,900	2,400	29.100	—	
130	280	93	NU 2326 E	NJ	NUP	—	—	920000	1230000	1,900	2,400	28.500	—	
140	300	102	NU 2328	NJ	NUP	—	—	920000	1250000	1,800	2,200	36.800	—	
140	300	102	NU 2328 E	NJ	NUP	—	—	1020000	1380000	1,800	2,200	35.900	—	
150	320	108	NU 2330	NJ	NUP	—	—	1020000	1400000	1,700	2,000	44.700	—	
150	320	108	NU 2330 E	NJ	NUP	—	—	1160000	1600000	1,700	2,000	48.200	—	

Single Row Series: NU/N 10

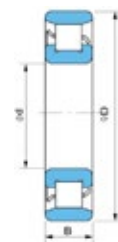

Principal dimensions			Designation						Basic Load Ratings		Speed Ratings		Mass	
d	D	B							Dynamic C	Static C ₀	Reference speed	Limiting speed		
mm									N		r/min		NU	N
25	47	12							NU 1005	—	—	N	—	14300
30	55	13	NU 1006	—	—	N	—	19700	19600	12,000	15,000	0.123	0.121	
35	62	14	NU 1007	—	—	N	—	22600	23200	11,000	13,000	0.185	0.182	
40	68	15	NU 1008	—	—	N	—	27300	29000	10,000	12,000	0.226	0.223	
45	75	16	NU 1009	—	—	N	—	32500	35500	9,000	11,000	0.284	0.289	
50	80	16	NU 1010	—	—	N	—	32000	36000	8,500	10,000	0.310	0.306	
55	90	18	NU 1011	—	—	N	—	37500	44000	7,500	9,000	0.449	0.445	
60	95	18	NU 1012	—	—	N	—	40000	48500	6,700	8,500	0.484	0.477	
65	100	18	NU 1013	—	—	N	—	41000	51000	6,300	8,000	0.514	0.560	
70	110	20	NU 1014	—	—	N	—	58500	70500	6,000	7,100	0.712	0.702	
75	115	20	NU 1015	—	—	N	—	60000	74500	5,600	6,700	0.745	0.735	
80	125	22	NU 1016	—	—	N	—	72500	90500	5,300	6,300	1.030	0.994	
85	130	22	NU 1017	—	—	N	—	74500	95500	5,000	6,000	1.060	1.040	
90	140	24	NU 1018	—	—	N	—	88000	114000	4,800	5,600	1.360	1.340	
95	145	24	NU 1019	—	—	N	—	90500	120000	4,500	5,300	1.420	1.400	
100	150	24	NU 1020	—	—	N	—	93000	126000	4,300	5,300	1.480	1.460	
105	160	26	NU 1021	—	—	N	—	109000	149000	4,000	4,800	1.880	1.850	
110	170	28	NU 1022	—	—	N	—	131000	174000	3,800	4,500	2.340	2.310	
120	180	28	NU 1024	—	—	N	—	139000	191000	3,400	4,300	2.510	2.470	
130	200	33	NU 1026	—	—	N	—	172000	238000	3,200	3,800	3.830	3.770	
140	210	33	NU 1028	—	—	N	—	176000	250000	3,000	3,600	4.070	4.000	
150	225	35	NU 1030	—	—	N	—	202000	294000	2,800	3,400	4.900	4.830	



Double Row Series: NN/NUU

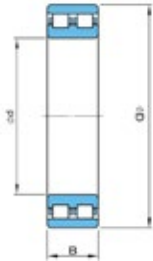

Principal dimensions			Designation	Basic Load Ratings		Speed ratings		Mass
d	D	B		Dynamic	Static	Reference speed	Limiting speed	
mm				C	C ₀	Grease	Oil	
				N		r/min		
30	55	19	NN3006	29000	34000	16,000	19,000	0.12
35	62	20	NN3007	39300	50000	14,000	17,000	0.26
40	68	21	NN3008	45000	58500	12,000	15,000	0.32
45	75	23	NN3009	54000	72000	11,000	14,000	0.41
50	80	23	NN3010	57000	80000	10,000	13,000	0.43
55	90	26	NN3011	72000	100000	9,000	11,000	0.65
60	95	26	NN3012	75000	110000	8,500	10,000	0.67
65	100	26	NN3013	76500	118000	8,000	9,500	0.74
70	110	30	NN3014	98000	151000	7,000	8,500	1.1
75	115	30	NN3015	100000	156000	6,700	8,000	1.1
80	125	34	NN3016	120000	186000	6,300	7,500	1.6
85	130	34	NN3017	125000	200000	6,000	7,000	1.6
90	140	37	NN3018	141000	224000	5,600	6,700	2.1
95	145	37	NN3019	146000	236000	5,300	6,300	2.1
100	140	40	NUU4920	129000	255000	5,300	6300	1.9
100	150	37	NN3020	152000	264000	5,300	6,300	2.2
105	145	40	NUU4921	129000	260000	5,300	6,300	2.0
105	160	41	NN3021	192000	310000	4,800	5,600	3.0
110	150	40	NUU4922	132000	270000	5,000	6,000	2.1
110	170	45	NN3022	226000	365000	4,500	5,300	3.8
120	165	45	NUU4924	176000	340000	4,500	5,300	2.76
120	180	46	NN3024	235000	405000	4,300	5,000	4.1
130	180	50	NUU4926	193000	390000	4,000	4,800	3.79
130	200	52	NN3026	294000	510000	3,800	4,500	6.1
140	190	50	NUU4928	190000	400000	3,800	4,500	4.11

Double Row Series: NN/NUU

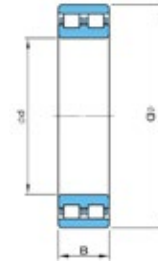

Principal dimensions			Designation	Basic Load Ratings		Speed ratings		Mass
d	D	B		Dynamic	Static	Reference speed	Limiting speed	
mm				C	C ₀	Grease	Oil	
				N		r/min		
140	210	53	NN3028	305000	520000	3,600	4,300	6.5
150	210	60	NUU4930	326000	655000	3,600	4,300	6.2
150	225	56	NN3030	339000	600000	3,400	4,000	7.9
160	220	60	NUU4932	335000	680000	3,400	4,000	6.55
160	240	60	NN3032	388000	670000	3,200	3,800	9.6
170	230	60	NUU4934	340000	720000	3,200	3,800	6.85
170	260	67	NN3034	458000	810000	3,000	3,600	13
180	250	69	NUU4936	405000	877000	3,000	3,600	10.2
180	280	74	NN3036	576000	1080000	2,800	3,400	17
190	260	69	NUU4938	412000	910000	2,800	3,400	10.6
190	290	75	NN3038	614000	1088000	2,600	3,200	18
200	280	80	NUU4940	490000	1040000	2,600	3,200	14.9
200	310	82	NN3040	715000	1271000	2,400	3,000	23
220	300	80	NUU4944	535000	1321000	2,400	3,000	16.2
220	340	90	NN3044	890000	1591000	2,200	2,800	33
240	320	80	NUU4948	556000	1300000	2,200	2,800	17.4
240	360	92	NN3048	850000	1560000	2,000	2,600	36
260	360	100	NUU4952	750000	1700000	2,000	2,600	30.2
260	400	104	NN3052	1060000	2000000	1,900	2,400	48
280	380	100	NUU4956	765000	1800000	1,900	2,400	32.2
280	420	106	NN3056	1080000	2080000	1,800	2,200	52
300	420	118	NUU4960	1188000	2943000	1,700	2,000	50
300	460	118	NN3060	1270000	2400000	1,600	1,900	72
320	440	118	NUU4964	1060000	2550000	1,600	1,900	52.7
320	480	121	NN3064	1320000	2600000	1,600	1,900	77



Needle Roller Bearings



Needle Roller Bearings

The Rolling Elements of Needle Roller Bearings are Cylindrical in shape with the Roller's length being far greater than it's diameter. These Bearings are used where limited space is available between Shaft and Housing.



Needle Roller Bearings

Compared with other types of rolling bearings, needle roller bearings have a small cross-sectional height and significant load-bearing capacity and rigidity relative to their volume. Also, because the inertial force action on them is limited, they are ideal choice for oscillating motion. Needle roller bearings contribute to compact and lightweight machine designs. They serve also as a ready replacement for sliding bearings.

Needle Roller Bearings are

- Capable of carrying high radial loads
- suitable for low and medium speed applications
- mainly used in Gearbox, Steering, Clutch, Differential, Engine, UV joints etc. in Automobiles

KG can offer following variants

- Needle Cages
- Needle Bushes
- Needle Rollers



Needle Roller Bearings

Apart from the list of items presented in the following pages, many other special type of Needle Roller Bearings can be developed to meet specific application requirements. Technical information for Bearings not appearing in our production program is available on request.

KG offers the following types of Needle Roller Bearings

- Needle roller and cage assembly
- Needle roller and cage assembly for connecting rods
- Full Compliment Type
- Drawn-cup needle roller bearing
- Needle bushes
- Needle cages
- Needle bushes

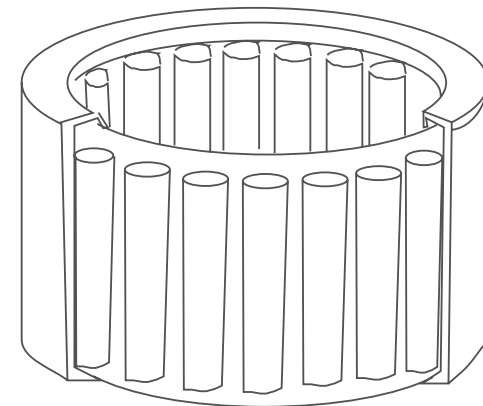

Note: Most of the Bearings listed in the following pages of this chapter are available with above suffixes, subject to design or manufacturing constraints.



Drawn Cup Needle Roller Bearing



Principal dimensions			Designation	Basic Load Ratings		Speed ratings		Mass kg
Fw	D	H		Dynamic C	Static C ₀	Reference speed	Limiting speed	
mm				N		r/min		
3	6,5	6	HK 0306	1250	835	33,000	50,000	0.0006
4	8	8	HK 0408	1770	1270	3,0000	45,000	0.0016
5	9	9	HK 0509	2640	2190	27,000	4,0000	0.0019
6	10	9	HK 0609	2660	2280	25,000	37,000	0.0022
7	11	9	HK 0709	3400	3250	23,000	34,000	0.0025
8	12	10	HK 0810	3850	3950	20,000	30,000	0.0032
9	13	10	HK 0910	4600	5050	18,000	27,000	0.0035
9	13	12	HK 0912	5650	6650	18,000	27,000	0.0042
10	14	10	HK 1010	4500	5100	16,000	24,000	0.0038
10	14	12	HK 1012	5900	7250	16,000	24,000	0.0045
10	14	15	HK 1015	7100	9150	16,000	24,000	0.0056
12	16	10	HK 1210	5050	6250	13,000	20,000	0.0046
12	18	12	HK 1212	6600	7300	13,000	20,000	0.0091
13	19	12	HK 1312	7300	8450	12,000	18,000	0.010
14	20	12	HK 1412	7200	8500	11,000	17,000	0.011
14	20	16	HK 1416	10700	14000	11,000	17,000	0.015
15	21	12	HK 1512	7500	9100	11,000	16,000	0.011
15	21	16	HK 1516	10700	14400	11,000	16,000	0.015
16	22	12	HK 1612	7750	9700	10,000	15,000	0.012
16	22	16	HK 1616	11100	15300	10,000	15,000	0.016
17	23	12	HK 1712	8500	11100	9,500	14,000	0.012
18	24	12	HK 1812	8300	10900	8,500	13,000	0.013
18	24	16	HK 1816	11800	17300	8,500	13,000	0.018
20	26	12	HK 2012	9250	13000	8,000	12,000	0.014
20	26	16	HK 2016	13000	20100	8,000	12,000	0.019

Drawn Cup Needle Roller Bearing



Principal dimensions			Designation	Basic Load Ratings		Speed ratings		Mass kg
Fw	D	H		Dynamic C	Static C ₀	Reference speed	Limiting speed	
mm				N		r/min		
20	26	20	HK 2020	16400	27100	8,000	12,000	0.022
22	28	12	HK 2212	9750	14300	7,500	11,000	0.027
22	28	16	HK 2216	13600	22100	7,500	11,000	0.015
25	32	12	HK 2512	11800	16300	6,500	9,500	0.021
25	32	16	HK 2516	15900	24000	6,500	9,500	0.027
25	32	26	HK 2526	26400	46000	6,500	9,500	0.045
28	35	16	HK 2816	17300	27600	5,500	8,500	0.030
28	35	20	HK 2820	21300	36000	5,500	8,500	0.038
30	37	12	HK 3012	13000	19500	5,500	8,000	0.024
30	37	16	HK 3016	18100	30000	5,500	8,000	0.032
30	37	20	HK 3020	22300	39500	5,500	8,000	0.040
30	37	26	HK 3026	29100	55000	5,500	8,000	0.053
35	42	12	HK 3512	14000	22800	4,700	7,000	0.028
35	42	16	HK 3516	19700	35000	4,700	7,000	0.037
35	42	20	HK 3520	24800	47500	4,700	7,000	0.046
40	47	12	HK 4012	15100	26000	4,000	6,000	0.031
40	47	16	HK 4016	21100	40000	4,000	6,000	0.041
45	52	20	HK 4520	27600	59000	3,700	5,500	0.058
50	58	20	HK 5020	31500	63000	3,200	4,800	0.072
50	58	25	HK 5025	38500	82000	3,200	4,800	0.090
22	28	20	HK 2220	17200	29800	7,500	11,000	0.026
25	32	20	HK 2520	20300	33000	6,500	9,500	0.034
40	47	20	HK 4020	25900	52500	4,000	6,000	0.052
45	52	16	HK 4516	21600	43000	3,700	5,500	0.046



Drawn Cup Needle Roller Bearing



Principal dimensions			Designation	Basic Load Ratings		Speed ratings		Mass kg
Fw	D	H		Dynamic C	Static C ₀	Reference speed	Limiting speed	
mm				N		r/min		
12	18	14	HK 1214	6600	7300	10,000	14,900	0.011
14	20	14	HK 1414	7200	8500	10,000	14,900	0.012
15	21	14	HK 1514	7500	9100	10,000	14,900	0.013
16	22	14	HK 1614	7750	9700	10,000	14,900	0.013
18	24	14	HK 1814	8300	10900	9,000	13,400	0.015
20	26	16	HK 2016	9250	13000	8,000	11,900	0.019
20	26	18	HK 2018	13000	20100	8,000	11,900	0.021
22	28	16	HK 2216	9750	14300	7,500	11,200	0.020
22	28	18	HK 2218	13600	22100	7,500	11,200	0.024
25	32	16	HK 2516	11800	16300	6,500	9,600	0.027
25	32	18	HK 2518	15900	24000	6,500	9,600	0.031
28	35	20	HK 2820	17300	27600	5,500	8,200	0.037
30	37	16	HK 3016	13000	19500	5,500	8,200	0.027
30	37	18	HK 3018	18100	30000	5,500	8,200	0.037
35	42	16	HK 3516	14000	22800	4,600	6,800	0.036
35	42	18	HK 3518	19700	35000	4,600	6,800	0.037
40	47	16	HK 4016	15100	26000	4,000	5,900	0.041
40	47	18	HK 4018	21100	40000	4,000	5,900	0.047
45	52	18	HK 4518	21600	43000	3,600	5,300	0.054
50	58	22	HK 5022	31500	63000	3200	4,700	0.086

Machined Needle Roller Bearing

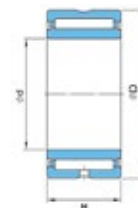

Principal dimensions			Designation	Basic Load Ratings		Speed ratings		Mass kg
d	D	H		Dynamic C	Static C ₀	Reference speed	Limiting speed	
mm				N		r/min		
5	13	10	NA 495	2670	2350	23,000	34,000	0.007
6	15	10	NA 496	3150	3000	21,000	32,000	0.009
7	17	10	NA 497	3600	3650	20,000	30,000	0.010
8	19	11	NA 498	4300	3950	19,000	28,000	0.016
9	20	11	NA 499	4850	4900	17,000	26,000	0.017
10	22	13	NA 4900	8600	9200	16,000	24,000	0.024
12	24	13	NA 4901	9550	10900	15,000	23,000	0.026
12	24	22	NA 6901	15400	20000	15,000	23,000	0.046
15	28	13	NA 4902	10300	12800	13,000	20,000	0.036
15	28	18	NA 5902	14100	19100	13,000	20,000	0.052
15	28	23	NA 6902	17600	25300	13,000	20,000	0.064
17	30	13	NA 4903	11200	14600	12,000	18,000	0.056
17	30	18	NA 5903	15200	21700	12,000	18,000	0.037
17	30	23	NA 6903	18200	27200	12,000	18,000	0.069
20	37	17	NA 4904	21300	25500	11,000	16,000	0.074
20	37	23	NA 5904	28400	37000	11,000	16,000	0.151
20	37	30	NA 6904	36500	50500	11,000	16,000	0.141
22	39	17	NA 49/22	23200	29300	9,500	14,000	0.080



Machined Needle Roller Bearing

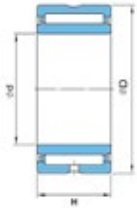

Principal dimensions			Designation	Basic Load Ratings		Speed ratings		Mass kg
d	D	H		Dynamic C	Static C ₀	Reference speed	Limiting speed	
mm				N		r/min		
22	39	23	NA 59/22	26400	37500	9,500	14,000	0.134
22	39	30	NA 69/22	40000	58500	9,500	14,000	0.154
25	42	17	NA 4905	24000	31500	8,500	13,000	0.088
25	42	23	NA 5905	30500	43000	8,500	13,000	0.139
25	42	30	NA 6905	41500	63000	8,500	13,000	0.162
28	45	17	NA 49/28	24800	33500	8500	13,000	0.098
28	45	23	NA 59/28	32000	45500	8,500	13,000	0.142
28	45	30	NA 69/28	43000	67000	8,500	13,000	0.179
30	47	17	NA 4906	25500	35500	7,500	11,000	0.101
30	47	23	NA 5906	32500	48500	7,500	11,000	0.152
30	47	30	NA 6906	42500	67500	7,500	11,000	0.185
32	52	20	NA 49/32	31500	47500	6,500	10,000	0.157
32	52	27	NA 59/32	38000	61000	6,500	10,000	0.241
32	52	36	NA 69/32	47500	82000	6,500	10,000	0.286
35	55	20	NA 4907	32000	50000	6,500	9,500	0.171
35	55	27	NA 5907	39000	64500	6,500	9,500	0.256
35	55	36	NA 6907	49000	86500	6,500	9,500	0.310
40	62	22	NA 4908	43500	66500	5,500	8,500	0.232
40	62	30	NA 5908	53000	92500	5,500	8,500	0.348
40	62	40	NA 6908	67000	116000	5,500	8,500	0.426

Machined Needle Roller Bearing

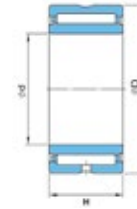

Principal dimensions			Designation	Basic Load Ratings		Speed ratings		Mass kg
d	D	H		Dynamic C	Static C ₀	Reference speed	Limiting speed	
mm				N		r/min		
45	68	22	NA 4909	46000	73000	5,000	7,500	0.270
45	68	30	NA 5909	56000	101000	5,000	7,500	0.396
45	68	40	NA 6909	70500	127000	5,000	7,500	0.437
50	72	22	NA 4910	48000	80000	4,700	7,000	0.276
50	72	30	NA 5910	58000	110000	4,700	7,000	0.498
50	72	40	NA 6910	74000	139000	4,700	7,000	0.529
55	80	25	NA 4911	58500	99500	4,300	6,500	0.396
55	80	34	NA 5911	76500	140000	4,300	6,500	0.559
55	80	45	NA 6911	94000	183000	4,300	6,500	0.726
60	85	25	NA 4912	61500	108000	4,000	6,000	0.427
60	85	34	NA 5912	80500	153000	4,000	6,000	0.614
60	85	45	NA 6912	95500	191000	4,000	6,000	0.758
65	90	25	NA 4913	62500	112000	3,700	5,500	0.454
65	90	34	NA 5913	84000	165000	3,700	5,500	0.655
65	90	45	NA 6913	97000	198000	3,700	5,500	0.779
70	100	30	NA 4914	85500	156000	3,300	5,000	0.727
70	100	40	NA 5914	103000	187000	3,300	5,000	1.06
70	100	54	NA 6914	130000	267000	3,300	5,000	1.34
75	105	30	NA 4915	87000	162000	3,100	4,700	0.776
75	105	40	NA 5915	109000	205000	3,100	4,700	1.13



Machined Needle Roller Bearing

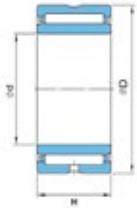

Principal dimensions			Designation	Basic Load Ratings		Speed ratings		Mass
d	D	H		Dynamic	Static	Reference speed	Limiting speed	
mm				C	C ₀	r/min	kg	
				N				
75	105	54	NA 6915	132000	277000	3100	4,700	1.45
80	110	30	NA 4916	90500	174000	2900	4,400	0.82
80	110	40	NA 5916	115000	223000	2900	4,400	1.15
80	110	54	NA 6916	137000	298000	2900	4,400	1.53
85	120	35	NA 4917	112000	237000	2,700	4,000	1.24
85	120	46	NA 5917	137000	290000	2,700	4,000	1.76
85	120	63	NA 6917	169000	400000	2,700	4,000	2.25
90	125	35	NA 4918	116000	252000	2,500	3,800	1.31
90	125	46	NA 5918	143000	310000	2,500	3,800	1.84
90	125	63	NA 6918	175000	425000	2,500	3,800	2.44
95	130	35	NA 4919	118000	260000	2,400	3,600	1.36
95	130	46	NA 5919	149000	335000	2,400	3,600	1.98
95	130	63	NA 6919	177000	440000	2,400	3,600	2.63
100	140	40	NA 4920	127000	260000	2,300	3,500	1.93
100	140	54	NA 5920	182000	395000	2,300	3,500	2.85
110	140	30	NA 4822	93500	210000	2,200	3,300	1.11
110	150	40	NA 4922	131000	279000	2,100	3,200	2.08
110	150	54	NA 5922	193000	440000	2,100	3,200	2.98
120	150	30	NA 4824	99500	233000	2,100	3,100	1.17
120	165	45	NA 4924	180000	380000	2,000	3,000	2.84

Machined Needle Roller Bearing



Principal dimensions			Designation	Basic Load Ratings		Speed ratings		Mass
d	D	H		Dynamic	Static	Reference speed	Limiting speed	
mm				C	C ₀	r/min	kg	
				N				
120	165	60	NA 5924	245000	525000	2,000	3,000	3.92
130	165	35	NA 4826	118000	305000	1,900	2,800	1.6
130	180	50	NA 4926	202000	455000	1,800	2,700	3.9
130	180	67	NA 5926	294000	685000	1,800	2,700	5.6
140	175	35	NA 4828	121000	315000	1,700	2,600	1.82
140	190	50	NA 4928	209000	485000	1,700	2,500	4.05
140	190	67	NA 5928	310000	755000	1,700	2,500	6.18
150	190	40	NA 4830	152000	390000	1,600	2,400	2.72
150	210	60	NA 4930	261000	610000	1,600	2,400	5.33
160	200	40	NA 4832	160000	425000	1,500	2,300	2.9
160	220	60	NA 4932	270000	650000	1,500	2,200	5.6
170	215	45	NA 4834	185000	495000	1,500	2,200	3.99
170	230	60	NA 4934	279000	690000	1,400	2,100	5.87
180	225	45	NA 4836	195000	540000	1,400	2,100	4.19
180	250	69	NA 4936	375000	890000	1,300	2,000	8.58
190	240	50	NA 4838	227000	680000	1,300	1,900	5.62
190	260	69	NA 4938	390000	945000	1,300	1,900	8.68
200	250	50	NA 4840	231000	705000	1,200	1,800	5.84
200	280	80	NA 4940	505000	1180000	1,200	1,800	12.2
220	270	50	NA 4844	244000	780000	1,100	1,700	6.37



Machined Needle Roller Bearing

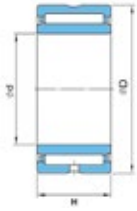

Principal dimensions			Designation	Basic Load Ratings		Speed ratings		Mass
d	D	H		Dynamic	Static	Reference speed	Limiting speed	
mm				C	C ₀	r/min	kg	
				N				
220	300	80	NA 4944	525000	1270000	1,100	1,600	13.5
240	300	60	NA 4848	360000	1080000	1,000	1,500	10
240	320	80	NA 4948	540000	1350000	1,000	1,500	14.7
260	320	60	NA 4852	375000	1160000	950	1,400	10.8
260	360	100	NA 4952	805000	1900000	950	1,400	25.9
280	350	69	NA 4856	455000	1300000	850	1,300	15.5
280	380	100	NA 4956	835000	2030000	850	1,300	27.5
300	380	80	NA 4860	625000	1770000	800	1,200	22
300	420	118	NA 4960	1080000	2640000	800	1,200	42.5
320	400	80	NA 4864	640000	1850000	750	1,100	23.2
320	440	118	NA 4964	1120000	2820000	750	1,100	45.2
340	420	80	NA 4868	655000	1940000	750	1,100	24.1
340	460	118	NA 4968	1160000	3000000	750	1,100	47.3
360	440	80	NA 4872	665000	2020000	650	1,000	25.7
360	480	118	NA 4972	1200000	3200000	650	1,000	49
380	480	100	NA 4876	1000000	2840000	650	950	44.5
380	520	140	NA 4976	1400000	3750000	650	950	73.6
400	540	140	NA 4980	1450000	4000000	600	900	76.6
420	560	140	NA 4984	1500000	4250000	550	850	89.8
440	600	160	NA 4988	1750000	4600000	550	800	123

Machined Needle Roller Bearing



Principal dimensions			Designation	Basic Load Ratings		Speed ratings	Mass	
d	D	H		Dynamic	Static	Reference speed		
mm				C	C ₀	r/min		kg
				N				
10	22	14	NA 4900 RS	7200	8500	10,000	0.025	
12	24	14	NA 4901 RS	7750	9700	10,000	0.028	
15	28	14	NA 4902 RS	8300	11200	10,000	0.036	
17	30	14	NA 4903 RS	8500	11900	9,000	0.039	
20	37	18	NA 4904 RS	15200	19900	8,000	0.080	
25	42	18	NA 4905 RS	16000	22600	6,500	0.093	
30	47	18	NA 4906 RS	18000	27400	5,500	0.107	
35	55	21	NA 4907 RS	22700	39500	4,800	0.175	
40	62	23	NA 4908 RS	27800	53500	4,200	0.252	
45	68	23	NA 4909 RS	28600	57000	3,800	0.290	
50	72	23	NA 4910 RS	30500	64000	3,400	0.295	



Machined Needle Roller Bearing

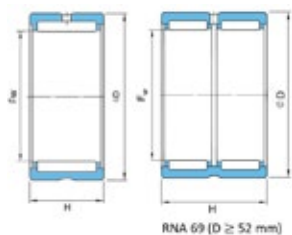

Principal dimensions			Designation	Basic Load Ratings		Speed ratings	Mass
Fw	D	H		Dynamic	Static	Reference speed	
mm				C	C ₀	r/min	
				N		kg	
14	22	13	RNA 4900 2RS	7200	8500	10,000	0.016
16	24	13	RNA 4901 2RS	7750	9700	10,000	0.018
20	28	13	RNA 4902 2RS	8300	11200	10,000	0.022
22	30	13	RNA 4903 2RS	8500	11900	9,000	0.022
25	37	17	RNA 4904 2RS	15200	19900	8,000	0.055
30	42	17	RNA 4905 2RS	16000	22600	6,500	0.063
35	47	17	RNA 4906 2RS	18000	27400	5,500	0.072
42	55	20	RNA 4907 2RS	22700	39500	4,800	0.113
48	62	22	RNA 4908 2RS	27800	53500	4,200	0.154
52	68	22	RNA 4909 2RS	28600	57000	3,800	0.157
58	72	22	RNA 4910 2RS	30500	64000	3,400	0.160

Needle roller bearings, with machined rings, without an inner ring

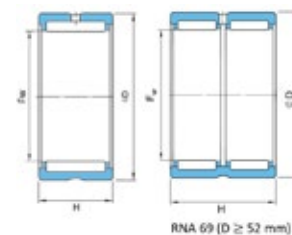

Principal dimensions			Designation	Basic Load Ratings		Speed ratings		Mass
Fw	D	H		Dynamic	Static	Reference speed	Limiting speed	
mm				C	C ₀	r/min		
				N		kg		
7	13	10	RNA 495	2670	2350	23,000	34,000	0.0055
8	15	10	RNA 496	3150	3000	21,000	32,000	0.0073
9	17	10	RNA 497	3600	3650	20,000	30,000	0.0095
10	19	11	RNA 498	4300	3950	19,000	28,000	0.013
12	20	11	RNA 499	4850	4900	17,000	26,000	0.013
14	22	13	RNA 4900	8600	9200	16,000	24,000	0.017
16	24	13	RNA 4901	9550	10900	15,000	23,000	0.017
16	24	22	RNA 6901	15400	20000	15,000	23,000	0.031
20	28	13	RNA 4902	10300	12800	13,000	20,000	0.022
20	28	18	RNA 5902	14100	19100	13,000	20,000	0.033
20	28	23	RNA 6902	17600	25300	13,000	20,000	0.040
22	30	13	RNA 4903	11200	14600	12,000	18,000	0.022
22	30	18	RNA 5903	15200	21700	12,000	18,000	0.035
22	30	23	RNA 6903	18200	27200	12,000	18,000	0.042
25	37	17	RNA 4904	21300	25500	11,000	16,000	0.052
25	37	23	RNA 5904	28400	37000	11,000	16,000	0.084
25	37	30	RNA 6904	36500	50500	11,000	16,000	0.100
28	39	17	RNA 49122	23200	29300	9,500	14,000	0.050
28	39	23	RNA 59122	26400	37500	9,500	14,000	0.092
28	39	30	RNA 69122	40000	58500	9,500	14,000	0.100
30	42	17	RNA 4905	24000	31500	8,500	13,000	0.061
30	42	23	RNA 5905	30500	43000	8,500	13,000	0.101
30	42	30	RNA 6905	41500	63000	8,500	13,000	0.112
32	45	17	RNA 49128	24800	33500	8,500	13,000	0.073



Needle roller bearings, with machined rings, without an inner ring

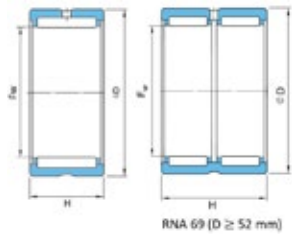

Principal dimensions			Designation	Basic Load Ratings		Speed ratings		Mass
Fw	D	H		Dynamic	Static	Reference speed	Limiting speed	
mm				C	C ₀	r/min	r/min	
				N				
32	45	23	RNA 59/28	32000	45500	8,500	13,000	0.108
32	45	30	RNA 69/28	43000	67000	8,500	13,000	0.135
35	47	17	RNA 4906	25500	35500	7,500	11,000	0.069
35	47	23	RNA 5906	32500	48500	7,500	11,000	0.108
35	47	30	RNA 6906	42500	67500	7,500	11,000	0.126
40	52	20	RNA 49/32	31500	47500	6,500	10,000	0.089
40	52	27	RNA 59/32	38000	61000	6,500	10,000	0.149
40	52	36	RNA 69/32	47500	82000	6,500	10,000	0.162
42	55	20	RNA 4907	32000	50000	6,500	9,500	0.107
42	55	27	RNA 5907	39000	64500	6,500	9,500	0.176
42	55	36	RNA 6907	49000	86500	6,500	9,500	0.193
48	62	22	RNA 4908	43500	66500	5,500	8,500	0.14
48	62	30	RNA 5908	53000	92500	5,500	8,500	0.225
48	62	40	RNA 6908	67000	116000	5,500	8,500	0.256
52	68	22	RNA 4909	46000	73000	5,000	7,500	0.182
52	68	30	RNA 5909	56000	101000	5,000	7,500	0.232
52	68	40	RNA 6909	70500	127000	5,000	7,500	0.273
58	72	22	RNA 4910	48000	80000	4,700	7,000	0.163
58	72	30	RNA 5910	58000	110000	4,700	7,000	0.289
58	72	40	RNA 6910	74000	139000	4,700	7,000	0.32
63	80	25	RNA 4911	58500	99500	4,300	6,500	0.255
63	80	34	RNA 5911	76500	140000	4,300	6,500	0.367
63	80	45	RNA 6911	94000	183000	4,300	6,500	0.47
68	85	25	RNA 4912	61500	108000	4,000	6,000	0.275

Needle roller bearings, with machined rings, without an inner ring

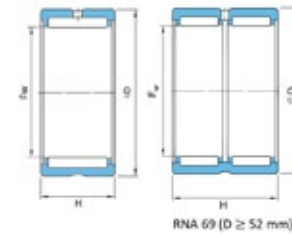

Principal dimensions			Designation	Basic Load Ratings		Speed ratings		Mass
Fw	D	H		Dynamic	Static	Reference speed	Limiting speed	
mm				C	C ₀	r/min	r/min	
				N				
68	85	34	RNA 5912	80500	153000	4,000	6,000	0.408
68	85	45	RNA 6912	95500	191000	4,000	6,000	0.488
72	90	25	RNA 4913	62500	112000	3,700	5,500	0.312
72	90	34	RNA 5913	84000	165000	3,700	5,500	0.462
72	90	45	RNA 6913	97000	198000	3,700	5,500	0.520
80	100	30	RNA 4914	85500	156000	3,300	5,000	0.460
80	100	40	RNA 5914	103000	187000	3,300	5,000	0.706
80	100	54	RNA 6914	130000	267000	3,300	5,000	0.857
85	105	30	RNA 4915	87000	162000	3,100	4,700	0.489
85	105	40	RNA 5915	109000	205000	3,100	4,700	0.745
85	105	54	RNA 6915	132000	277000	3,100	4,700	0.935
90	110	30	RNA 4916	90500	174000	2,900	4,400	0.516
90	110	40	RNA 5916	115000	223000	2,900	4,400	0.787
90	110	54	RNA 6916	137000	298000	2,900	4,400	0.987
100	120	35	RNA 4917	112000	237000	2,700	4,000	0.657
100	120	46	RNA 5917	137000	290000	2,700	4,000	1.00
100	120	63	RNA 6917	169000	400000	2,700	4,000	1.20
105	125	35	RNA 4918	116000	252000	2,500	3,800	0.697
105	125	46	RNA 5918	143000	310000	2,500	3,800	1.04
105	125	63	RNA 6918	175000	425000	2,500	3,800	1.33
110	130	35	RNA 4919	118000	260000	2,400	3,600	0.719
110	130	46	RNA 5919	149000	335000	2,400	3,600	1.13
110	130	63	RNA 6919	177000	440000	2,400	3,600	1.46
115	140	40	RNA 4920	127000	260000	2,300	3,500	1.15



Needle roller bearings, with machined rings, without an inner ring

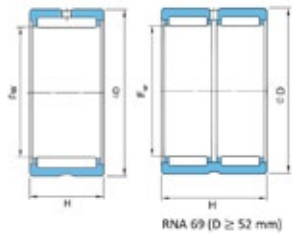

Principal dimensions			Designation	Basic Load Ratings		Speed ratings		Mass	
Fw	D	H		Dynamic	Static	Reference speed	Limiting speed		
mm				C	C ₀	r/min			kg
				N					
115	140	54	RNA 5920	182000	395000	2,300	3,500	1.76	
120	140	30	RNA 4822	93500	210000	2,200	3,300	0.67	
125	150	40	RNA 4922	131000	279000	2,100	3,200	1.24	
125	150	54	RNA 5922	193000	440000	2,100	3,200	1.89	
130	150	30	RNA 4824	99500	233000	2,100	3,100	0.73	
135	165	45	RNA 4924	180000	380000	2,000	3,000	1.86	
135	165	60	RNA 5924	245000	525000	2,000	3,000	2.67	
145	165	35	RNA 4826	118000	305000	1,900	2,800	0.95	
150	180	50	RNA 4926	202000	455000	1,800	2,700	2.21	
150	180	67	RNA 5926	294000	685000	1,800	2,700	3.21	
155	175	35	RNA 4828	121000	315000	1,700	2,600	1.02	
160	190	50	RNA 4928	209000	485000	1,700	2,500	2.35	
160	190	67	RNA 5928	310000	755000	1,700	2,500	3.48	
165	190	40	RNA 4830	152000	390000	1,600	2,400	1.6	
170	210	60	RNA 4930	261000	610000	1,600	2,400	2.98	
175	200	40	RNA 4832	160000	425000	1,500	2,300	1.7	
180	220	60	RNA 4932	270000	650000	1,500	2,200	3.1	
185	215	45	RNA 4834	185000	495000	1,500	2,200	2.54	
190	230	60	RNA 4934	279000	690000	1,400	2,100	3.22	
195	225	45	RNA 4836	195000	540000	1,400	2,100	2.68	
205	250	69	RNA 4936	375000	890000	1,300	2,000	4.48	
210	240	50	RNA 4838	227000	680000	1,300	1,900	3.21	
215	260	69	RNA 4938	390000	945000	1,300	1,900	4.53	
220	250	50	RNA 4840	231000	705000	1,200	1,800	3.35	

Needle roller bearings, with machined rings, without an inner ring

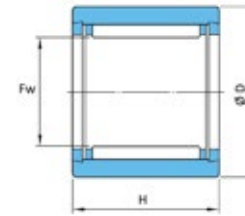

Principal dimensions			Designation	Basic Load Ratings		Speed ratings		Mass	
Fw	D	H		Dynamic	Static	Reference speed	Limiting speed		
mm				C	C ₀	r/min			kg
				N					
5	10	10	NK 5/10	2640	2190	27,000	40,000	0.0031	
5	10	12	NK 5/12	2720	2250	27,000	40,000	0.0037	
6	12	10	NK 6/10	2660	2280	25,000	37,000	0.0047	
6	12	12	NK 6/12	3400	3150	25,000	37,000	0.0057	
7	14	10	NK 7/10	2670	2350	23,000	34,000	0.0069	
7	14	12	NK 7/12	3400	3200	23,000	34,000	0.0082	
8	15	12	NK 8/12	4000	4100	21,000	32,000	0.0087	
8	15	16	NK 8/16	4850	5200	21,000	32,000	0.012	
9	16	12	NK 9/12	4550	5000	20,000	30,000	0.010	
9	16	16	NK 9/16	5500	6400	20,000	30,000	0.013	
10	17	12	NK 10/12	4550	5100	19,000	28,000	0.010	
10	17	16	NK 10/16	5450	6450	19,000	28,000	0.013	
12	19	12	NK 12/12	5000	6100	17,000	26,000	0.013	
12	19	16	NK 12/16	6000	7700	17,000	26,000	0.016	
14	22	16	NK 14/16	10300	11500	16,000	24,000	0.021	
14	22	20	NK 14/20	13000	15600	16,000	24,000	0.026	
15	23	16	NK 15/16	10900	12700	15,000	23,000	0.022	
15	23	20	NK 15/20	13800	17200	15,000	23,000	0.027	
16	24	16	NK 16/16	12200	14900	15,000	23,000	0.022	
16	24	20	NK 16/20	14600	18800	15,000	23,000	0.028	
17	25	16	NK 17/16	12100	15000	15,000	22,000	0.024	
17	25	20	NK 17/20	15400	20400	15,000	22,000	0.030	
18	26	16	NK 18/16	12700	16200	14,000	21,000	0.025	
18	26	20	NK 18/20	16100	22000	14,000	21,000	0.031	



Needle roller bearings, with machined rings, without an inner ring

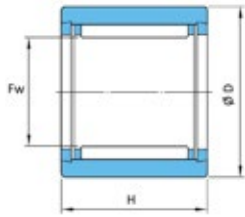

Principal dimensions			Designation	Basic Load Ratings		Speed ratings		Mass	
Fw	D	H		Dynamic	Static	Reference speed	Limiting speed		
mm				C	C ₀	r/min			kg
				N					
19	27	16	NK 19/16	13300	17400	14,000	21,000	0.026	
19	27	20	NK 19/20	16000	22200	14,000	21,000	0.032	
20	28	16	NK 20/16	13200	17500	13,000	20,000	0.027	
20	28	20	NK 20/20	16700	23800	13,000	20,000	0.034	
21	29	16	NK 21/16	13700	18700	13,000	19,000	0.028	
21	29	20	NK 21/20	18300	27100	13,000	19,000	0.035	
22	30	16	NK 22/16	14200	19900	12,000	18,000	0.034	
22	30	20	NK 22/20	18000	27000	12,000	18,000	0.037	
24	32	16	NK 24/16	15200	22300	11,000	17,000	0.032	
24	32	20	NK 24/20	18600	28800	11,000	17,000	0.04	
25	33	16	NK 25/16	15100	22400	11,000	16,000	0.033	
25	33	20	NK 25/20	19200	30500	11,000	16,000	0.042	
26	34	16	NK 26/16	15600	23600	10,000	15,000	0.034	
26	34	20	NK 26/20	19100	30500	10,000	15,000	0.042	
28	37	20	NK 28/20	22300	34000	9,500	14,000	0.052	
28	37	30	NK 28/30	26700	48000	9,500	14,000	0.082	
29	38	20	NK 29/20	22200	34000	9,500	14,000	0.054	
29	38	30	NK 29/30	27500	50500	9,500	14,000	0.084	
30	40	20	NK 30/20	22100	34000	8,500	13,000	0.065	
30	40	30	NK 30/30	33000	57000	8,500	13,000	0.098	
32	42	20	NK 32/20	23500	37500	8,500	13,000	0.068	
32	42	30	NK 32/30	34000	60500	8,500	13,000	0.102	
35	45	20	NK 35/20	24800	41500	7,500	11,000	0.074	
35	45	30	NK 35/30	36000	66500	7,500	11,000	0.112	

Needle roller bearings, with machined rings, without an inner ring

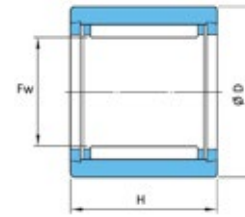

Principal dimensions			Designation	Basic Load Ratings		Speed ratings		Mass	
Fw	D	H		Dynamic	Static	Reference speed	Limiting speed		
mm				C	C ₀	r/min			kg
				N					
37	47	20	NK 37/20	25300	43500	7,500	11,000	0.077	
37	47	30	NK 37/30	36500	69500	7,500	11,000	0.107	
38	48	20	NK 38/20	25900	45000	7,500	11,000	0.079	
38	48	30	NK 38/30	37500	73000	7,500	11,000	0.107	
40	50	20	NK 40/20	26400	47000	6,500	10,000	0.083	
40	50	30	NK 40/30	38500	76000	6,500	10,000	0.125	
42	52	20	NK 42/20	26900	49000	6,500	9,500	0.086	
42	52	30	NK 42/30	39000	79000	6,500	9,500	0.130	
43	53	20	NK 43/20	27500	51000	6,500	9,500	0.086	
43	53	30	NK 43/30	40000	82000	6,500	9,500	0.133	
45	55	20	NK 45/20	28000	52500	6,000	9,000	0.092	
45	55	30	NK 45/30	41000	85500	6,000	9,000	0.139	
47	57	20	NK 47/20	28800	55500	5,500	8,500	0.095	
47	57	30	NK 47/30	42500	91500	5,500	8,500	0.142	
50	62	25	NK 50/25	38500	74500	5,500	8,000	0.158	
50	62	35	NK 50/35	51000	106000	5,500	8,000	0.221	
55	68	25	NK 55/25	41000	82000	5,000	7,500	0.193	
55	68	35	NK 55/35	54000	118000	5,000	7,500	0.267	
60	72	25	NK 60/25	41000	85000	4,300	6,500	0.185	
60	72	35	NK 60/35	57000	130000	4,300	6,500	0.258	
65	78	25	NK 65/25	45000	98000	4,000	6,000	0.221	
65	78	35	NK 65/35	60000	142000	4,000	6,000	0.31	
68	82	25	NK 68/25	44500	89000	4,000	6,000	0.241	
68	82	35	NK 68/35	63000	139000	4,000	6,000	0.338	



Needle roller bearings, with machined rings, without an inner ring

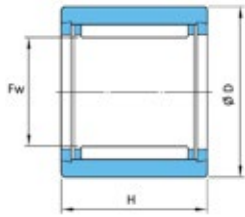

Principal dimensions			Designation	Basic Load Ratings		Speed ratings		Mass	
Fw	D	H		Dynamic	Static	Reference speed	Limiting speed		
mm				C	C ₀	r/min			kg
				N					
70	85	25	NK 70/25	45000	91500	3,700	5,500	0.275	
70	85	35	NK 70/35	64000	144000	3,700	5,500	0.386	
73	90	25	NK 73/25	54000	100000	3,700	5,500	0.302	
73	90	35	NK 73/35	76500	156000	3,700	5,500	0.428	
75	92	25	NK 75/25	55000	104000	3,700	5,500	0.315	
75	92	35	NK 75/35	78000	162000	3,700	5,500	0.492	
80	95	25	NK 80/25	57000	119000	3,300	5,000	0.301	
80	95	35	NK 80/35	79500	184000	3,300	5,000	0.425	
85	105	25	NK 85/25	70500	123000	3,100	4,700	0.404	
85	105	35	NK 85/35	100000	193000	3,100	4,700	0.517	
90	110	25	NK 90/25	71500	128000	2,900	4,400	0.426	
90	110	35	NK 90/35	104000	208000	2,900	4,400	0.604	
95	115	26	NK 95/26	74500	137000	2,800	4,200	0.364	
95	115	36	NK 95/36	108000	223000	2,800	4,200	0.652	
100	120	26	NK 100/26	73500	137000	2,700	4,000	0.487	
100	120	36	NK 100/36	107000	223000	2,700	4,000	0.679	
105	125	26	NK 105/26	76500	147000	2,500	3,800	0.506	
105	125	36	NK 105/36	111000	238000	2,500	3,800	0.713	
110	130	30	NK 110/30	97500	204000	2,400	3,600	0.612	
110	130	40	NK 110/40	129000	292000	2,400	3,600	0.830	
120	140	40	NK 120/40	113000	268000	2,200	3,300	0.910	
130	150	40	NK 130/40	116000	283000	2,100	3,100	0.980	
145	170	32	NK 145/32	111000	238000	1,900	2,800	1.12	
145	170	42	NK 145/42	153000	360000	1,900	2,800	1.49	

Needle roller bearings, with machined rings, with an inner ring

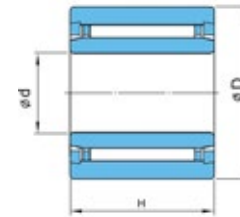

Principal dimensions			Designation	Basic Load Ratings		Speed ratings	Mass	
d	D	H		Dynamic	Static	Reference speed		
mm				C	C ₀	r/min		kg
				N				
5	15	12	NKI 5/12	3950	4100	32,000	0.012	
5	15	16	NKI 5/16	5100	5800	32,000	0.015	
6	16	12	NKI 6/12	4500	5000	31,000	0.014	
6	16	16	NKI 6/16	5900	7100	31,000	0.018	
7	17	12	NKI 7/12	4750	5500	29,000	0.014	
7	17	16	NKI 7/16	6200	7800	29,000	0.018	
9	19	12	NKI 9/12	6400	7100	27,000	0.017	
9	19	16	NKI 9/16	9000	11000	27,000	0.022	
10	22	16	NKI 10/16	10100	11500	25,000	0.029	
10	22	20	NKI 10/20	12800	15600	25,000	0.037	
12	24	16	NKI 12/16	11300	13900	23,000	0.033	
12	24	20	NKI 12/20	14400	18800	23,000	0.042	
15	27	16	NKI 15/16	13000	17400	22,000	0.039	
15	27	20	NKI 15/20	16500	23600	22,000	0.049	
17	29	16	NKI 17/16	13500	18700	21,000	0.043	
17	29	20	NKI 17/20	17100	25500	21,000	0.054	
20	32	16	NKI 20/16	15000	22300	18,000	0.049	
20	32	20	NKI 20/20	19000	30500	18,000	0.061	
22	34	16	NKI 22/16	15300	23600	17,000	0.052	
22	34	20	NKI 22/20	19400	32000	17,000	0.065	



Needle roller bearings, with machined rings, with an inner ring

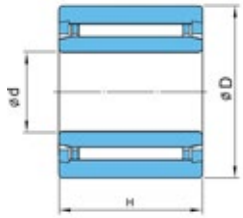

Principal dimensions			Designation	Basic Load Ratings		Speed ratings	Mass kg
d	D	H		Dynamic C	Static C ₀	Reference speed	
mm				N		r/min	
25	38	20	NKI 25/20	21900	34000	15,000	0.08
25	38	30	NKI 25/30	32500	57000	15,000	0.12
28	42	20	NKI 28/20	23100	37500	14,000	0.097
28	42	30	NKI 28/30	34500	63000	14,000	0.15
30	45	20	NKI 30/20	24300	41500	13,000	0.11
30	45	30	NKI 30/30	36500	69000	13,000	0.17
32	47	20	NKI 32/20	24900	43500	12,000	0.12
32	47	30	NKI 32/30	37000	73000	12,000	0.18
35	50	20	NKI 35/20	26000	47000	11,000	0.13
35	50	30	NKI 35/30	39000	79000	11,000	0.19
38	53	20	NKI 38/20	27000	51000	11,000	0.14
38	53	30	NKI 38/30	40500	85000	11,000	0.21
40	55	20	NKI 40/20	27500	53000	10,000	0.14
40	55	30	NKI 40/30	41000	88000	10,000	0.22
42	57	20	NKI 42/20	28500	56000	10,000	0.15
42	57	30	NKI 42/30	43000	94000	10,000	0.22
45	62	25	NKI 45/25	38000	74000	9,000	0.23
45	62	35	NKI 45/35	50000	106000	9,000	0.32
50	68	25	NKI 50/25	40000	82000	8,500	0.27
50	68	35	NKI 50/35	53000	118000	8,500	0.38

Needle roller bearings, with machined rings, with an inner ring

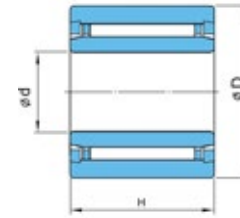

Principal dimensions			Designation	Basic Load Ratings		Speed ratings	Mass kg
d	D	H		Dynamic C	Static C ₀	Reference speed	
mm				N		r/min	
55	72	25	NKI 55/25	42000	90000	7,500	0.27
55	72	35	NKI 55/35	56000	130000	7,500	0.38
60	82	25	NKI 60/25	43500	89000	7,000	0.4
60	82	35	NKI 60/35	62000	139000	7,000	0.55
65	90	25	NKI 65/25	53000	100000	6,500	0.47
65	90	35	NKI 65/35	75000	156000	6,500	0.66
70	95	25	NKI 70/25	56000	119000	6,000	0.52
70	95	35	NKI 70/35	78000	184000	6,000	0.74
75	105	25	NKI 75/25	69000	123000	5,500	0.64
75	105	35	NKI 75/35	98000	193000	5,500	0.91
80	110	25	NKI 80/25	72000	132000	5,000	0.68
80	110	35	NKI 80/35	103000	208000	5,000	0.96
85	115	26	NKI 85/26	73000	137000	4,800	0.75
85	115	36	NKI 85/36	107000	223000	4,800	1.05
90	120	26	NKI 90/26	76000	146000	4,600	0.78
90	120	36	NKI 90/36	111000	237000	4,600	1.1
95	125	26	NKI 95/26	78000	155000	4,400	0.82
95	125	36	NKI 95/36	114000	250000	4,400	1.15
100	130	30	NKI 100/30	98000	210000	4,200	1
100	130	40	NKI 100/40	127000	290000	4,200	1.35



Track Roller Bearings

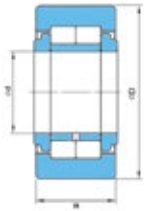

Principal dimensions			Designation	Basic Load Ratings		Speed ratings	Mass
d	D	H		Dynamic	Static	Reference speed	
mm				C	C ₀	r/min	
				N			
15	35	18	NUTR 15	22300	25700	5,500	0.100
17	40	20	NUTR 17	24100	29100	4,700	0.147
20	47	24	NUTR 20	38500	48000	4,000	0.245
25	52	24	NUTR 25	42500	57500	3,300	0.281
30	62	28	NUTR 30	56500	72500	2,900	0.466
35	72	28	NUTR 35	62000	85500	2,400	0.630
40	80	30	NUTR 40	87000	125000	2,100	0.817
45	85	30	NUTR 45	92000	137000	1,900	0.883
50	90	30	NUTR 50	96500	150000	1,800	0.950

Thrust Needle Roller Bearings

Thrust Needle Roller Bearings are also supplied alongwith washers "AS"



Principal dimensions			Designation	Basic Load Ratings		Speed ratings		Mass
d	D	H		Dynamic	Static	Reference speed	Limiting speed	
mm				C	C ₀	r/min		
				N				
10	24	2	AXK 1024	9150	25300	3,500	14,000	0.0028
12	26	2	AXK 1226	9850	28900	3,300	13,000	0.003
15	28	2	AXK 1528	11300	36000	2,800	11,000	0.0035
17	30	2	AXK 1730	11900	39500	2,500	10,000	0.004
20	35	2	AXK 2035	13200	46500	2,100	8,500	0.005
25	42	2	AXK 2542	14600	58000	1,800	7,000	0.007
30	47	2	AXK 3047	16300	69500	1,500	6,000	0.008
35	52	2	AXK 3552	17800	81500	1,400	5,500	0.010
40	60	3	AXK4060	27400	110000	1,200	4,700	0.0185
45	65	3	AXK 4565	29800	128000	1,100	4,300	0.0205
50	70	3	AXK 5070	31500	143000	1,000	3,900	0.0235
55	78	3	AXK 5578	38000	186000	900	3,500	0.0308
60	85	3	AXK 6085	44500	234000	800	3,200	0.039
65	90	3	AXK 6590	46500	254000	750	3,000	0.040
70	95	4	AXK 7095	53500	253000	750	2,900	0.060
75	100	4	AXK 75100	55000	266000	700	2,700	0.061
80	105	4	AXK 80105	56500	279000	650	2,600	0.063
85	110	4	AXK 85110	57500	291000	600	2,400	0.0668
90	120	4	AXK 90120	71000	390000	600	2,300	0.086
100	135	4	AXK 100135	90500	550000	500	2,000	0.112
110	145	4	AXK 110145	93500	590000	480	1,900	0.122
120	155	4	AXK 120155	99000	650000	430	1,700	0.131
130	170	5	AXK 130170	140000	900000	400	1,600	0.205
140	180	5	AXK 140180	145000	960000	380	1,500	0.219
150	190	5	AXK 150190	149000	1020000	350	1,400	0.232
160	200	5	AXK 160200	154000	1070000	330	1,300	0.246



Drawn cup Needle Roller Bearings

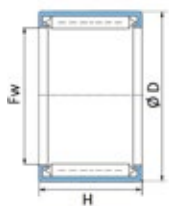

For Connecting Rod Small End

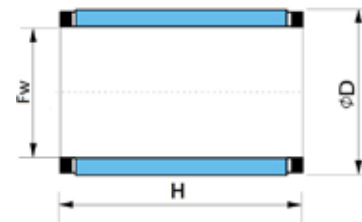

Principal dimensions			Designation	Torque capacity	Speed ratings		Mass
Fw	D	H			Reference speed	Limiting speed	
mm					Nm	r/min	
4	8	6	HF 0406	0.34	9,800	23,800	1.0
6	10	12	HF 0612	1.76	9,100	16,100	2.0
8	12	12	HF 0812	3.15	8,400	11,900	3.5
10	14	12	HF 1012	5.3	7,700	9,800	4.0
12	18	16	HF 1216	12.2	5,600	7,700	11.6
14	20	16	HF 1416	17.3	5,600	6,600	13.0
16	22	16	HF 1616	20.5	5,200	5,900	14.0
18	24	16	HF 1816	24.1	5,200	5,200	15.5
20	26	16	HF 2016	28.5	4,500	4,900	17.0
25	32	20	HF 2520	66	3,800	3,800	30.9
30	37	20	HF 3020	90	3,100	3,100	36.0
35	42	20	HF 3520	121	2,700	2,700	40.0

Principal dimensions			Designation	Basic Load Ratings		Mass
Fw	D	H		Dynamic	Static	
mm				N		
10.000	14.000	12.500	10 KV 14 12.5	500	470	5.000
10.000	14.000	12.800	10 KV 14 13	760	830	5.500
10.000	14.000	13.800	10 KV 14 14	660	680	6.000
12.000	15.000	14.800	12 KV 15 15	660	870	5.000
12.000	16.000	12.800	12 KV 16 13	740	840	5.000
16.000	16.000	15.800	12 KV 16 16	820	940	7.500
14.000	18.000	12.800	14 KV 18 13	730	850	6.000
14.000	18.000	16.300	14 KV 18 16.5	920	1140	8.000
14.000	18.000	17.300	14 KV 18 17.5	970	1230	10.000
14.000	18.000	19.800	14 KV 18 20	970	1230	12.000
14.000	19.000	17.100	14 KV 19 17.3	1110	1260	12.000
15.000	19.000	19.800	15 KV 19 20	1080	1430	13.000
16.000	20.000	21.200	16 KV 20 19.5	1020	1350	13.000
16.000	20.000	21.200	16 KV 20 21.5	1330	1560	13.500
16.000	20.000	22.300	16 KV 20 22.5	1330	1560	14.000



For Connecting Rod Big End

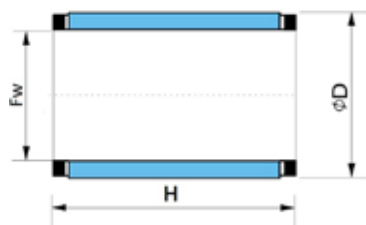

Principal dimensions			Designation	Basic Load Ratings		Mass
Fw	D	H		Dynamic	Static	
mm				N		gm
12.000	17.000	9.800	12 KT 17 10	620	575	5.100
16.000	21.000	9.800	16 KT 21 10	760	810	7.000
16.000	21.000	9.800	16 KT 21 10 C	760	810	7.000
16.000	21.000	11.800	16 KT 21 12 C	900	1000	8.000
16.000	22.000	11.800	16 KT 22 12	1030	1060	10.000
16.000	22.000	11.800	16 KT 22 12 C	1030	1060	10.000
18.000	24.000	11.800	18 KT 24 12	1170	1290	11.000
18.000	24.000	11.800	18 KT 24 12 C	1170	1290	11.000
18.000	24.000	13.300	18 KT 24 13.5 C	1360	1560	12.000
20.000	27.000	16.800	20 KT 26 17 C	1460	1760	14.000
22.000	28.000	13.800	22 KT 28 14 C	1390	1690	14.000
22.000	28.000	14.800	22 KT 28 15 C	1480	1830	15.500
22.000	28.000	15.800	22 KT 28 16 C	1460	1830	16.000
22.000	29.000	13.800	22 KT 29 14 C	1600	1940	18.000
22.000	29.000	15.400	22 KT 29 15.6	1700	2000	20.000
25.000	30.000	13.800	25 KT 30 14 S	1430	2080	14.000
28.000	33.000	13.800	28 KT 33 14 S	1640	2570	18.000
28.000	36.000	15.800	28 KT 36 16 S	2430	3090	30.000
29.000	39.000	15.800	29 KT 39 16 C	2420	2670	40.000
30.000	38.000	15.800	30 KT 38 16 C	2420	3130	32.000

For Gear Box

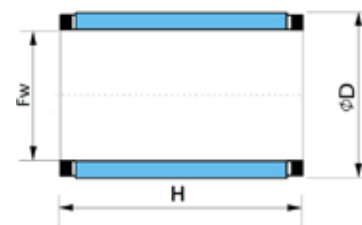

Principal dimensions			Designation	Basic Load Ratings		Mass
Fw	D	H		Dynamic	Static	
mm				N		gm
16.000	21.000	21.700	16 NV 21 22	1430	1800	16.000
18.000	22.000	16.800	18 NV 22 17	1100	1550	11.000
20.000	28.000	19.800	20 NT 28 20	2110	2360	29.000
25.000	30.000	19.800	25 NT 30 20	1935	3060	21.000
25.000	30.000	23.800	25 NT 30 24	2150	3490	24.000
28.000	35.000	19.800	28 NT 35 20	2230	3010	32.000
30.000	35.000	19.800	30 NT 35 20	2020	3420	37.000
35.000	39.000	33.800	35 DV 39 34	2560	5700	42.000
40.000	44.000	34.400	40 DV 44 34.6	2750	6560	50.000



Full Compliment Type



Principal dimensions			Designation	Basic Load Ratings		Mass
Fw	D	H		Dynamic	Static	
mm				N		gm
10.000	15.000	9.350	10 HGM 15 10	620	860	6.000
12.000	18.000	10.000	12 HGM 18 10	870	1110	14.000
12.000	20.000	12.000	12 HGM 20 12	1240	1430	8.000
13.000	19.000	12.000	13 HGM 19 12	1040	1500	12.000
Full Compliment Needle Bush: Type H. HM.						
28.000	36.000	20.000	28 HM 36 20	3075	3090	45.000
35.000	43.000	20.000	35 HM 43 20	3450	7000	58.000
38.100	47.625	25.400	H 24 16	4880	9970	98.000
38.100	47.620	31.750	H 24 20	6130	13370	124.000

For Gear Box



Principal dimensions			Designation	Basic Load Ratings		Mass
Fw	D	H		Dynamic	Static	
mm				N		gm
8.000	12.000	10.000	8 HR 12 10	340	240	3.500
9.000	13.000	10.000	9 HR 13 10	380	280	4.000
9.000	13.000	12.000	9 HR 13 12	470	370	4.500
9.000	16.000	12.000	9 HR 16 12	490	405	8.000
10.000	14.000	10.000	10 HR 14 10	390	290	4.000
10.000	14.000	12.000	10 HR 14 12	490	390	4.500
10.000	14.000	15.000	10 HR 14 15	600	500	5.500
12.000	16.000	10.000	12 HR 16 10	440	350	5.000
12.000	18.000	12.000	12 HR 18 12	580	420	9.000
13.000	19.000	12.000	13 HR 19 12	600	450	10.000
14.000	20.000	12.000	14 HR 20 12	680	520	10.000
14.000	20.000	16.000	14 HR 20 16	960	820	10.000
15.000	21.000	12.000	15 HR 21 12	700	550	11.000
15.000	21.000	16.000	15 HR 21 16	930	820	15.000
15.000	21.000	22.000	15 HR 21 22	1180	1110	20.000
16.000	22.000	12.000	16 HR 22 12	680	550	16.000
16.000	22.000	16.000	16 HR 22 16	970	860	16.000



For Gear Box



Principal dimensions			Designation	Basic Load Ratings		Mass
Fw	D	H		Dynamic	Static	
mm				N		gm
16.000	22.000	22.000	16 HR 22 22	1160	1090	22.000
17.000	23.000	12.000	17 HR 23 12	700	580	12.000
17.000	25.000	18.000	17 HR 25 18 RS	1200	900	22.000
18.000	24.000	12.000	18 HR 24 12	720	610	13.000
18.000	24.000	16.000	18 HR 24 16	1030	960	17.000
20.000	26.000	12.000	20 HR 26 12	765	670	19.000
20.000	26.000	16.000	20 HR 26 16	1130	1100	24.000
20.000	26.000	20.000	20 HR 26 20	1390	1440	24.000

Principal dimensions			Designation	Basic Load Ratings		Mass
Fw	D	H		Dynamic	Static	
mm				N		gm
25.000	32.000	12.000	25 HR 32 12	970	830	21.000
25.000	32.000	16.000	25 HR 32 16	1380	1310	27.000
25.000	32.000	20.000	25 HR 32 20	1770	1800	34.000
25.000	32.000	26.000	25 HR 32 26	2260	2470	45.000
28.000	35.000	16.000	28 HR 35 16	1440	1430	30.000
28.000	35.000	20.000	28 HR 35 20	1660	1770	37.000
30.000	37.000	12.000	30 HR 37 12	1010	940	24.000
30.000	37.000	16.000	30 HR 37 16	1450	1480	32.000
30.000	37.000	20.000	30 HR 37 20	1850	2020	38.000
30.000	37.000	26.000	30 HR 37 26	2350	2750	52.000
35.000	42.000	12.000	35 HR 42 12	1100	1080	28.000
35.000	42.000	16.000	35 HR 42 16	1570	1710	37.000
35.000	42.000	20.000	35 HR 42 20	2000	2330	46.000
40.000	47.000	12.000	40 HR 47 12	1180	1230	32.000
40.000	47.000	16.000	40 HR 47 16	1685	1940	42.000
40.000	47.000	20.000	40 HR 47 20	2150	2660	52.000
40.000	52.000	16.000	40 HR 52 16	1780	2170	47.000
40.000	52.000	20.000	40 HR 52 20	2280	2950	57.000
11.113	17.463	16.670	16 O2 38	1360	680	11.000



Tapered Roller Bearings



Tapered Roller Bearings

The Rolling Elements of this Bearing are Tapered Rollers. They form a line contact with the Raceway of Inner Ring and Outer Ring (Cup). These are separable type Bearings. Tapered Roller Bearings can also be made according to special dimensional requirement, but within basic design limitations. They are available in both metric and inch dimensions.



Tapered Roller Bearings

Tapered Roller Bearings are

- Capable of carrying high radial loads, as well as axial loads in one direction
- Suitable for low and medium speed applications

KG can offer following variants

- Single Row type 302, 303, 303D, 320, 322, 323, 330, 331 and 332 series
- Double Row type -DRT (details available on request)
- Four Row type -FRT (details available on request)
- Precision grade P0 and higher precision grade P6 on request
- Pressed Steel, riveted, machined Brass or Polyamide Cage
- Metric and Inch type

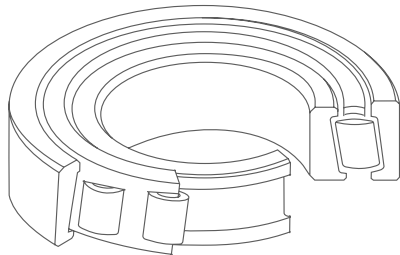

Tapered Roller Bearings

KG standard suffixes for Tapered Roller Bearings

A	Modified internal design.
AR/RA	Flange on the Cup.
D	Used with 303 series to denote equivalence to 313 series in other Brands.
M	Machined Brass Cage.
P or TN	Plastic / Polyamide / Nylon Cage.
P6	Dimensional and running accuracy confirming to ISO class 6.
Q1-Q4	KG internal reference codes. For details please contact KG International FZCO.

Double Row Tapered Roller Bearings

Double row tapered roller bearings can carry heavy loads and are stiff. They are suitable for the accommodation of combined (radial and axial) loads and can locate a shaft axially in both directions with a given axial clearance or a given preload. Their main use is in gearboxes, hoisting equipment, rolling mills and machines used in the mining industry etc



Note: Most of the Bearings listed in the following pages of this chapter are available with above suffixes, subject to design or manufacturing constraints.



Single Row Series: 302



Principal dimensions					Designation	Basic Load Ratings		Speed Ratings		Mass
d	D	T	B	C		Dynamic	Static	Reference speed	Limiting speed	
						C	C ₀			
mm						N		r/min		
15	35	11.75	11	10	30202	16300	15000	13,000	23,000	0.05
17	40	13.25	12	11	30203	20500	20300	9,900	13,000	0.0800
20	47	15.25	14	12	30204	28200	28700	8,800	12,000	0.1270
25	52	16.25	15	13	30205	31500	34000	7,300	9,800	0.1540
30	62	17.25	16	14	30206	43500	48000	6,300	8,400	0.2410
35	72	18.25	17	15	30207	55500	61500	5,500	7,400	0.3440
40	80	19.75	18	16	30208	61000	67000	4,900	6,600	0.4350
45	85	20.75	19	16	30209	67500	78500	4,400	5,900	0.4950
50	90	21.75	20	17	30210	77000	93000	4,000	5,300	0.5630
55	100	22.75	21	18	30211	93000	111000	3,600	4,900	0.7400
60	110	23.75	22	19	30212	105000	125000	3,400	4,500	0.9490
65	120	24.75	23	20	30213	123000	148000	3,100	4,200	1.1800
70	125	26.25	24	21	30214	131000	162000	2,900	3,900	1.2600
75	130	27.25	25	22	30215	139000	175000	2,700	3,600	1.4100
80	140	28.25	26	22	30216	160000	200000	2,500	3,400	1.7200
85	150	30.5	28	24	30217	183000	232000	2,400	3,200	2.1400
90	160	32.5	30	26	30218	208000	267000	2,200	3,000	2.6600
95	170	34.5	32	27	30219	226000	290000	2,100	2,800	3.0700
100	180	37	34	29	30220	258000	335000	2,000	2,700	3.7800
105	190	39	36	30	30221	287000	380000	1,900	2,500	4.3900
110	200	41	38	32	30222	325000	435000	1,800	2,400	5.1800
120	215	43.5	40	34	30224	345000	470000	1,700	2,200	6.2300
130	230	43.75	40	34	30226	375000	505000	1,500	2,000	7.2500
140	250	45.75	42	36	30228	420000	570000	1,400	1,900	9.2600
150	270	49	45	38	30230	450000	605000	1,300	1,700	11.2000
160	290	52	48	40	30232	525000	720000	1,200	1,600	12.9000
170	310	57	52	43	30234	610000	845000	1,100	1,500	17.0000
180	320	57	52	43	30236	630000	890000	1,100	1,400	17.7000
190	340	60	55	46	30238	715000	1000000	1,000	1,300	20.8000
200	360	64	58	48	30240	785000	1110000	950	1,300	25.4000

Single Row Series: 303



Principal dimensions					Designation	Basic Load Ratings		Speed Ratings		Mass
d	D	T	B	C		Dynamic	Static	Reference speed	Limiting speed	
						C	C ₀			
mm						N		r/min		
15	42	14.25	13	11	30302	23200	20800	9,900	13,000	0.0980
17	47	15.25	14	12	30303	28900	26300	9,000	12,000	0.1340
20	52	16.25	16	13	30304	35500	34000	8,000	11,000	0.1760
25	62	18.25	17	15	30305	48500	47500	6,700	8,900	0.2720
30	72	20.75	19	16	30306	60000	61000	5,700	7,600	0.4080
35	80	22.75	21	18	30307	75000	77000	5,000	6,600	0.5400
40	90	25.25	23	20	30308	91500	102000	4,400	5,900	0.7690
45	100	27.25	25	22	30309	111000	126000	4,000	5,300	1.0100
50	110	29.25	27	23	30310	133000	152000	3,600	4,800	1.3100
55	120	31.5	29	25	30311	155000	179000	3,300	4,400	1.6600
60	130	33.5	31	26	30312	180000	210000	3,000	4,000	2.0600
65	140	36	33	28	30313	203000	238000	2,800	3,700	2.5500
70	150	38	35	30	30314	230000	272000	2,600	3,500	3.0600
75	160	40	37	31	30315	255000	305000	2,400	3,200	3.5700
80	170	42.5	39	33	30316	291000	350000	2,300	3,000	4.4100
85	180	44.5	41	34	30317	305000	365000	2,100	2,900	5.2000
90	190	46.5	43	36	30318	335000	405000	2,000	2,700	6.0300
95	200	49.5	45	38	30319	365000	445000	1,900	2,500	6.9800
100	215	51.5	47	39	30320	410000	500000	1,800	2,400	8.5600
105	225	53.5	49	41	30321	435000	530000	1,700	2,300	9.7900
110	240	54.5	50	42	30322	480000	590000	1,600	2,200	11.4000
120	260	59.5	55	46	30324	560000	695000	1,500	2,000	14.2000
130	280	63.75	58	49	30326	650000	830000	1,400	1,800	17.4000
140	300	67.75	62	53	30328	735000	950000	1,300	1,700	21.2000
150	320	72	65	55	30330	825000	1070000	1,200	1,600	25.5000



Single Row Series: 303D



Principal dimensions					Designation	Basic Load Ratings		Speed Ratings		Mass
d	D	T	B	C		Dynamic	Static	Reference speed	Limiting speed	
mm						C	C ₀			
						N		r/min	kg	
25	62	18.25	17	13	30305 D	48500	47500	5,900	7,800	0.2840
30	72	20.75	19	14	30306 D	63500	70000	5,000	6,700	0.3980
35	80	22.75	21	15	30307 D	77000	85500	4,400	5,800	0.5300
40	90	25.25	23	17	30308 D	96000	109000	3,900	5,200	0.7380
45	100	27.25	25	18	30309 D	113000	130000	3,500	4,600	0.9580
50	110	29.25	27	19	30310 D	132000	154000	3,200	4,200	1.2500
55	120	31.5	29	21	30311 D	150000	176000	2,900	3,800	1.5900
60	130	33.5	31	22	30312 D	173000	204000	2,700	3,600	1.9700
65	140	36	33	23	30313 D	193000	229000	2,500	3,300	2.4200
70	150	38	35	25	30314 D	215000	256000	2,300	3,000	2.9200
75	160	40	37	26	30315 D	236000	283000	2,100	2,800	3.4700
80	170	42.5	39	27	30316 D	247000	293000	2,000	2,700	4.1100
85	180	44.5	41	28	30317 D	270000	320000	1,900	2,500	4.8500
90	190	46.5	43	30	30318 D	296000	355000	1,800	2,400	5.6600
95	200	49.5	45	32	30319 D	355000	435000	1,700	2,200	6.4700
100	215	56.5	51	35	30320 D	380000	470000	1,800	2,400	8.6700
105	225	58	53	36	30321 D	430000	535000	1,700	2,300	9.6800
110	240	63	57	38	30322 D	480000	590000	1,600	2,200	11.9000

Single Row Series: 320

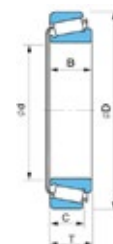

Principal dimensions					Designation	Basic Load Ratings		Speed Ratings		Mass
d	D	T	B	C		Dynamic	Static	Reference speed	Limiting speed	
mm						C	C ₀			
						N		r/min	kg	
25	47	15	15	11.5	32005	27800	33500	7,900	11,000	0.1140
28	52	16	16	12	320/28	33000	40500	7,300	9,700	0.1460
30	55	17	17	13	32006	37500	46000	6,900	9,200	0.1660
32	58	17	17	13	320/32	37000	46500	6,600	8,700	0.1810
35	62	18	18	14	32007	41500	52500	6,100	8,100	0.2240
40	68	19	19	14.5	32008	50000	65500	5,300	7,100	0.2730
45	75	20	20	15.5	32009	57500	76500	4,800	6,400	0.3460
50	80	20	20	15.5	32010	62500	88000	4,400	5,800	0.3660
55	90	23	23	17.5	32011	80500	118000	4,000	5,400	0.5630
60	95	23	23	17.5	32012	82000	123000	3,700	4,900	0.5760
65	100	23	23	17.5	32013	83000	128000	3,400	4,600	0.6300
70	110	25	25	19	32014	105000	160000	3,200	4,200	0.8480
75	115	25	25	19	32015	106000	167000	3,000	4,000	0.9090
80	125	29	29	22	32016	139000	216000	2,800	3,700	1.2800
85	130	29	29	22	32017	142000	224000	2,600	3,500	1.3500
90	140	32	32	24	32018	168000	270000	2,500	3,300	1.7900
95	145	32	32	24	32019	171000	280000	2,300	3,100	1.8300
100	150	32	32	24	32020	170000	281000	2,200	3,000	1.9100
105	160	35	35	26	32021	201000	335000	2,100	2,800	2.4200
110	170	38	38	29	32022	236000	390000	2,000	2,700	3.0700
120	180	38	38	29	32024	245000	420000	1,800	2,500	3.2500
130	200	45	45	34	32026	320000	545000	1,700	2,200	4.9600
140	210	45	45	34	32028	330000	580000	1,600	2,100	5.2800
150	225	48	48	36	32030	370000	655000	1,400	1,900	6.3700
160	240	51	51	38	32032	435000	790000	1,400	1,800	7.8000
170	260	57	57	43	32034	500000	895000	1,300	1,700	10.5000
180	280	64	64	48	32036	645000	1170000	1,200	1,600	14.5000
190	290	64	64	48	32038	655000	1210000	1,100	1,500	15.1000
200	310	70	70	53	32040	800000	1470000	1,100	1,400	19.3000



Single Row Series: 322



Principal dimensions					Designation	Basic Load Ratings		Speed Ratings		Mass
d	D	T	B	C		Dynamic C	Static C ₀	Reference speed	Limiting speed	
mm						N	r/min	kg		
17	40	17.25	16	14		32203	27300	28300	9,900	
20	47	19.25	18	15	32204	36500	39500	8,800	12,000	0.1600
25	52	19.25	18	16	32205	42000	47000	7,300	9,800	0.1870
30	62	21.25	20	17	32206	54500	64000	6,300	8,400	0.3010
35	72	24.25	23	19	32207	72500	87000	5,500	7,400	0.4570
40	80	24.75	23	19	32208	79500	93500	4,900	6,600	0.5580
45	85	24.75	23	19	32209	82000	100000	4,400	5,900	0.6070
50	90	24.75	23	19	32210	87500	109000	4,000	5,300	0.6480
55	100	26.75	25	21	32211	108000	134000	3,600	4,900	0.8760
60	110	29.75	28	24	32212	130000	164000	3,400	4,500	1.1800
65	120	32.75	31	27	32213	159000	206000	3,100	4,200	1.5800
70	125	33.25	31	27	32214	166000	220000	2,900	3,900	1.6800
75	130	33.25	31	27	32215	168000	224000	2,700	3,600	1.7400
80	140	35.25	33	28	32216	199000	265000	2,500	3,400	2.1800
85	150	38.5	36	30	32217	224000	300000	2,400	3,200	2.7500
90	160	42.5	40	34	32218	262000	360000	2,200	3,000	3.4900
95	170	45.5	43	37	32219	299000	415000	2,100	2,800	4.3000
100	180	49	46	39	32220	330000	465000	2,000	2,700	5.1200
105	190	53	50	43	32221	380000	540000	1,900	2,500	6.2500
110	200	56	53	46	32222	420000	605000	1,800	2,400	7.4300
120	215	61.5	58	50	32224	460000	680000	1,700	2,200	9.0800
130	230	67.75	64	54	32226	530000	815000	1,500	2,000	11.2000
140	250	71.75	68	58	32228	610000	920000	1,400	1,900	14.1000
150	270	77	73	60	32230	700000	1070000	1,300	1,700	18.2000
160	290	84	80	67	32232	890000	1420000	1,200	1,600	23.5000
170	310	91	86	71	32234	1000000	1600000	1,100	1,500	28.7000
180	320	91	86	71	32236	1030000	1690000	1,100	1,400	30.7000
190	340	97	92	75	32238	1150000	1850000	1,000	1,300	36.1000
200	360	104	98	82	32240	1320000	2130000	950	1,300	43.4000

Single Row Series: 323



Principal dimensions					Designation	Basic Load Ratings		Speed Ratings		Mass
d	D	T	B	C		Dynamic C	Static C ₀	Reference speed	Limiting speed	
mm						N	r/min	kg		
17	47	20.25	19	16		32303	33500	34700	11,000	
20	52	22.25	21	18	32304	46500	48500	8,000	11,000	0.2450
25	62	25.25	24	20	32305	61500	64500	6,700	8,900	0.3810
30	72	28.75	27	23	32306	81000	90000	5,700	7,600	0.5830
35	80	32.75	31	25	32307	101000	115000	5,000	6,600	0.7870
40	90	35.25	33	27	32308	110000	140000	4,200	5,600	1.1000
45	100	38.25	36	30	32309	154000	191000	4,000	5,300	1.4600
50	110	42.25	40	33	32310	184000	232000	3,600	4,800	1.9200
55	120	45.5	43	35	32311	215000	275000	3,300	4,400	2.4400
60	130	48.5	46	37	32312	244000	315000	3,000	4,000	3.0200
65	140	51	48	39	32313	273000	350000	2,800	3,700	3.6600
70	150	54	51	42	32314	310000	405000	2,600	3,500	4.4600
75	160	58	55	45	32315	355000	470000	2,400	3,200	5.3500
80	170	61.5	58	48	32316	395000	525000	2,300	3,000	6.4100
85	180	63.5	60	49	32317	405000	525000	2,100	2,900	7.1500
90	190	67.5	64	53	32318	450000	595000	2,000	2,700	8.5700
95	200	71.5	67	55	32319	505000	670000	1,900	2,500	10.1000
100	215	77.5	73	60	32320	570000	770000	1,800	2,400	12.7000
105	225	81.5	77	63	32321	610000	825000	1,700	2,300	14.5000
110	240	84.5	80	65	32322	620000	830000	1,600	2,200	16.9000
120	260	90.5	86	69	32324	815000	1130000	1,500	2,000	22.4000



Single Row Series: 329



Principal dimensions					Designation	Basic Load Ratings		Speed Ratings		Mass	
d	D	T	B	C		Dynamic	Static	Reference speed	Limiting speed		
mm						C	C ₀				r/min
						N					
35	55	14	14	11.5	32907	27400	37500	6,800	9,000	0.1210	
40	62	15	15	12	32908	32500	48000	5,900	7,800	0.1610	
45	68	15	15	12	32909	33500	51500	5,300	7,000	0.1880	
50	72	15	14	12	32910	31500	50500	4,700	6,300	0.1920	
55	80	17	17	14	32911	44500	73500	4,300	5,700	0.2740	
60	85	17	17	14	32912	51000	83000	4,000	5,300	0.2960	
65	90	17	17	14	32913	48500	85000	3,700	4,900	0.3150	
70	100	20	20	16	32914	68500	110000	3,400	4,600	0.4870	
75	105	20	20	16	32915	69500	114000	3,200	4,300	0.5110	
80	110	20	20	16	32916	72000	121000	3,000	4,000	0.5400	
85	120	23	23	18	32917	94000	157000	2,800	3,800	0.7730	
90	125	23	23	18	32918	97500	168000	2,700	3,600	0.8170	
95	130	23	23	18	32919	101000	178000	2,500	3,400	0.8510	
100	140	25	24	20	32920	97500	162000	2,400	3,200	1.0800	
105	145	25	25	20	32921	126000	219000	2,300	3,000	1.2000	
110	150	25	25	20	32922	127000	226000	2,200	2,900	1.2300	
120	165	29	29	23	32924	162000	294000	2,000	2,600	1.7700	
130	180	32	32	25	32926	194000	350000	1,800	2,400	2.3600	
140	190	32	32	25	32928	200000	375000	1,700	2,200	2.5100	
150	210	38	38	30	32930	268000	490000	1,600	2,100	3.9200	
160	220	38	38	30	32932	276000	520000	1,500	1,900	4.1500	
170	230	38	38	30	32934	286000	560000	1,400	1,800	4.4000	
180	250	45	45	34	32936	350000	700000	1,300	1,700	6.5400	
190	260	45	45	34	32938	355000	710000	1,200	1,600	6.7700	
200	280	51	51	39	32940	485000	895000	1,100	1,500	8.8800	
220	300	51	51	39	32944	480000	950000	1,000	1,400	10.2000	
240	320	51	51	39	32948	490000	1000000	940	1,200	10.9000	
260	360	63.5	63.5	48	32952	705000	1430000	860	1,100	18.8000	

Single Row Series: 330



Principal dimensions					Designation	Basic Load Ratings		Speed Ratings		Mass	
d	D	T	B	C		Dynamic	Static	Reference speed	Limiting speed		
mm						C	C ₀				r/min
						N					
25	47	17	17	14	33005	33500	42300	8,300	11,000	0.14	
30	55	20	20	16	33006	43200	55200	7,000	9,400	0.203	
35	62	21	21	17	33007	53000	70000	6,300	8,100	0.273	
40	68	22	22	18	33008	62000	87000	5,600	7,400	0.33	
45	75	24	24	19	33009	71000	103000	5,700	6,600	0.44	
50	80	24	24	19	33010	75000	113000	5,200	6,100	0.45	
55	90	27	27	21	33011	94000	142000	4,800	5,400	0.67	
60	95	27	27	21	33012	95000	14800	4,500	5,200	0.73	
65	100	27	27	21	33013	100000	161000	4,400	5,000	0.78	
70	110	31	31	25.5	33014	136000	223000	3,800	4,700	1.1	
75	115	31	31	25.5	33015	139000	232000	3,400	4,400	1.16	
80	125	36	36	29.5	33016	175000	290000	3,100	4,100	1.65	
85	130	36	36	29.5	33017	184000	215000	2,900	3,800	1.74	
90	140	39	39	32.5	33018	216000	315000	2,700	3,500	2.22	
95	145	39	39	32.5	33019	221000	380000	2,500	3,300	2.3	
100	150	39	39	32.5	33020	225000	395000	2,400	3,200	2.39	
105	160	43	43	34	33021	265000	450000	2,200	2,800	3.05	
110	170	47	47	37	33022	295000	520000	2,000	2,600	3.89	
120	180	48	48	38	33024	310000	560000	1,900	2,400	4.2	
130	200	55	55	43	33026	410000	740000	1,800	2,200	6.44	
140	210	56	56	44	33028	415000	770000	1,800	2,000	6.88	
150	225	59	59	46	33030	550000	890000	1,700	2,000	8.48	



Single Row Series: 331

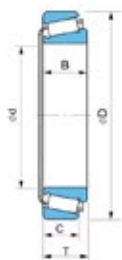

Principal dimensions					Designation	Basic Load Ratings		Speed Ratings		Mass
d	D	T	B	C		Dynamic C	Static C ₀	Reference speed	Limiting speed	
mm						N		r/min		
40	75	26	26	20.5	33108	79500	103000	5,200	6,900	0.4940
45	80	26	26	20.5	33109	84500	115000	4,700	6,200	0.5420
50	85	26	26	20	33110	86500	121000	4,200	5,600	0.5800
55	95	30	30	23	33111	111000	155000	3,900	5,200	0.8460
60	100	30	30	23	33112	113000	164000	3,600	4,700	0.9120
65	110	34	34	26.5	33113	144000	211000	3,300	4,400	1.2800
70	120	37	37	29	33114	174000	260000	3,500	5,700	1.71
75	125	37	37	29	33115	178000	275000	3,300	5,400	1.81
80	130	37	37	29	33116	188000	300000	3,050	5,200	1.93
85	140	41	41	32	33117	221000	350000	2,950	4,750	2.5
90	150	45	45	35	33118	265000	420000	2,800	4,450	3.45
100	165	52	52	40	33120	325000	540000	2,600	4,000	4.13
105	175	56	56	44	33121	360000	600000	2,600	3,800	4.43
110	180	56	56	43	33122	370000	630000	2,400	3,600	5.64
120	200	62	62	48	33124	460000	770000	2,100	3,300	7.6

Single Row Series: 332

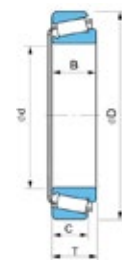

Principal dimensions					Designation	Basic Load Ratings		Speed Ratings		Mass
d	D	T	B	C		Dynamic C	Static C ₀	Reference speed	Limiting speed	
mm						N		r/min		
25	52	22	22	18	33205	47500	57500	7,300	9,800	0.2170
30	62	25	25	19.5	33206	65000	77000	6,300	8,400	0.3440
35	72	28	28	22	33207	87500	109000	5,500	7,400	0.5310
40	80	32	32	25	33208	103000	132000	4,900	6,600	0.7280
45	85	32	32	25	33209	107000	141000	4,400	5,900	0.7830
50	90	32	32	24.5	33210	115000	158000	4,000	5,300	0.8520
55	100	35	35	27	33211	138000	188000	3,600	4,900	1.1500
60	110	38	38	29	33212	161000	223000	3,400	4,500	1.5500
65	120	41	41	32	33213	195000	265000	3,100	4,200	1.9800
70	125	41	41	32	33214	201000	282000	2,900	3,900	2.1000
75	130	41	41	31	33215	208000	298000	2,700	3,600	2.2000
80	140	46	46	35	33216	250000	365000	2,500	3,400	2.9200
85	150	49	49	37	33217	284000	420000	2,400	3,200	3.5800



Inch Series

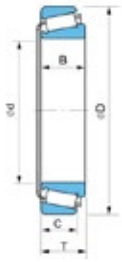

Principal dimensions					Designation	Basic Load Ratings		Speed Ratings		Mass
d	D	T	B	C		Dynamic	Static	Reference speed	Limiting speed	
mm						C	C ₀	speed	speed	
						N		r/min		kg
12.700	34.988	10.998	10.988	8.730	45050/4138	12300	11600	12,000	16,000	0.053
14.989	34.988	10.998	10.988	8.730	4059/4138	12300	11600	12,000	16,000	0.049
15.875	41.275	14.288	14.681	11.112	03062/03162	20300	18700	10,000	13,000	0.092
15.875	42.862	14.288	14.288	9.525	11590/11520	17600	17500	8,700	12,000	0.103
15.875	42.862	16.670	16.670	13.945	17580/17520	26700	26000	9,800	13,000	0.122
15.875	47.000	14.381	14.381	11.112	05062/05185	24000	24200	8,600	11,000	0.131
15.875	49.225	19.845	21.539	14.288	09062/09195	38500	39000	8,500	11,000	0.203
16.993	47.000	14.381	14.381	11.112	05066/05185	24000	24200	8,600	11,000	0.127
17.462	39.878	13.843	14.605	10.668	11749/11710	23800	24200	10,000	13,000	0.084
19.050	39.992	12.014	11.153	9.525	06075/6157	12800	12800	10,000	13,000	0.065
19.050	45.237	15.494	16.637	12.065	11949/11910	28300	28600	8,900	12,000	0.122
19.050	47.000	14.381	14.381	11.112	05075/05185	24000	24200	8,600	11,000	0.121
19.050	49.225	18.034	19.050	14.288	09067/09195	38500	39000	8,500	11,000	0.179
19.050	49.225	19.845	21.539	14.288	09074/09195	38500	39000	8,500	11,000	0.188
19.050	49.225	19.845	21.539	14.288	09078/09195	38500	39000	8,500	11,000	0.188
19.050	49.225	21.209	19.050	17.462	09067/09194	38500	39000	8,000	11,000	0.195

Inch Series

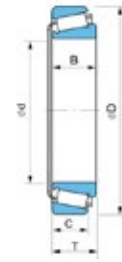

Principal dimensions					Designation	Basic Load Ratings		Speed Ratings		Mass
d	D	T	B	C		Dynamic	Static	Reference speed	Limiting speed	
mm						C	C ₀	speed	speed	
						N		r/min		kg
19.050	49.225	21.209	19.050	17.462	09067/09196	38500	39000	7,200	11,000	0.198
19.050	53.975	22.225	21.839	15.875	21075/21212	40000	39000	8,600	11,000	0.248
19.050	56.896	19.368	19.837	15.875	1775/1729	42500	46500	7,500	9,600	0.242
19.987	47.000	14.381	14.381	11.112	05079/05185	24000	24200	8,500	11,000	0.117
20.000	50.005	13.495	14.260	9.525	07079/07196	26000	27900	8,200	10,000	0.138
20.625	49.225	19.845	21.539	14.288	09081/09195	38500	39000	8,500	11,000	0.179
20.638	49.225	19.845	19.845	15.875	12580/12520	37500	39000	8,200	11,000	0.182
21.430	50.005	17.526	18.288	13.970	12649/12610	38000	39000	8,000	11,000	0.169
21.986	45.974	15.494	16.637	12.065	12749/12711	29600	34000	8,400	11,000	0.123
22.225	50.005	13.495	14.260	9.525	07087/07196	26000	27900	7,500	10,000	0.130
22.225	50.005	17.526	18.288	13.970	12648/12610	38000	39000	8,000	11,000	0.165
22.225	52.388	19.368	20.168	14.288	1380/1328	40500	43000	7,600	10,000	0.200
22.225	53.975	19.368	20.168	14.288	1380/1329	40500	43000	7,600	10,000	0.215
22.225	56.896	19.368	19.837	15.875	1755/1729	42500	46500	7,300	9,600	0.256
22.225	57.150	22.225	22.225	17.462	1280/1220	47000	49500	7,200	9,500	0.286
22.606	47.000	15.500	15.500	12.000	72849/72810	27500	32500	8,400	11,000	0.125



Inch Series

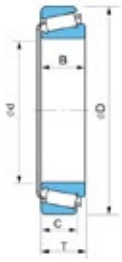

Principal dimensions					Designation	Basic Load Ratings		Speed Ratings		Mass	
d	D	T	B	C		Dynamic C	Static C ₀	Reference speed	Limiting speed		
mm						N		r/min			kg
23.813	50.005	13.495	14.260	9.525		07093/07196	26000	27900	7,600		10,000
23.813	50.292	14.224	14.732	10.668	44640/44610	28800	34000	7,500	9,900	0.137	
23.813	56.896	19.368	19.837	15.875	1779/1729	42500	46500	7,300	9,600	0.247	
24.981	50.005	13.495	14.260	9.525	07098/07196	26000	27900	7,600	10,000	0.118	
25.000	50.005	13.495	14.260	9.525	07097/07196	26000	27900	7,600	10,000	0.118	
25.159	50.005	13.495	14.260	9.525	07096/07196	26000	27900	7,600	10,000	0.117	
25.400	50.005	13.495	14.260	9.525	07100/07196	26000	27900	7,600	10,000	0.117	
25.400	50.005	13.495	14.260	9.525	07100S/07196	26000	27900	7,600	10,000	0.116	
25.400	50.292	14.224	14.732	10.668	44643/44610	28800	34000	7,500	9,900	0.130	
25.400	51.994	15.011	14.260	12.700	07100/07204	27900	27900	7,600	10,000	0.144	
25.400	56.896	19.368	19.837	15.875	1780/1729	42500	46500	7,300	9,600	0.238	
25.400	57.150	19.431	19.431	14.732	84548/84510	42000	48500	7,000	9,200	0.241	
25.400	59.530	23.368	23.114	18.288	84249/84210	50000	57500	6,900	9,100	0.324	
25.400	60.325	19.842	17.462	15.875	15578/15523	39500	45500	6,800	8,900	0.271	
25.400	61.912	19.050	20.638	14.288	15101/15243	46500	54000	6,200	8,200	0.300	
25.400	62.000	19.050	20.638	14.288	15100/15245	46500	54000	6,200	8,200	0.299	
25.400	62.000	19.050	20.638	14.288	15101/15245	46500	54000	6,200	8,200	0.301	

Inch Series

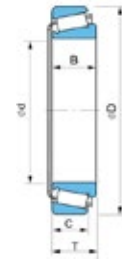

Principal dimensions					Designation	Basic Load Ratings		Speed Ratings		Mass	
d	D	T	B	C		Dynamic C	Static C ₀	Reference speed	Limiting speed		
mm						N		r/min			kg
25.400	62.000	19.050	20.638	14.288		15102/15245	46500	54000	6,200		8,200
25.400	62.000	20.638	20.638	15.875	15101/15244	46500	54000	6,200	8,200	0.315	
25.400	63.500	20.638	20.638	15.875	15101/15250	46500	54000	6,200	8,200	0.333	
25.400	63.500	20.638	20.638	15.875	15101/15250X	46500	54000	6,200	8,200	0.333	
25.400	64.292	21.433	21.433	16.670	86643/86610	51500	64500	6,100	8,100	0.371	
25.400	65.088	22.225	21.463	15.875	23100/23256	47000	50500	5,800	7,600	0.360	
25.400	66.421	23.812	25.433	19.050	2687/2631	64500	72500	6,200	8,200	0.442	
26.157	62.000	19.050	20.638	14.288	15103/15245	46500	54000	6,200	8,200	0.296	
26.162	66.421	23.812	25.433	19.050	2682/2631	64500	72500	6,200	8,200	0.436	
26.988	50.292	14.224	14.732	10.668	44649/44610	28800	34000	7,500	9,900	0.120	
26.988	60.325	19.842	17.462	15.875	15580/15523	39500	45500	6,800	8,900	0.260	
26.988	62.000	19.050	20.638	14.288	15106/15245	46500	54000	6,200	8,200	0.291	
26.988	66.421	23.812	25.433	19.050	2688/2631	64500	72500	6,200	8,200	0.429	
28.575	56.896	19.845	19.355	15.875	1985/1930	40500	44500	6,800	8,900	0.217	
28.575	57.150	17.462	17.462	13.495	15590/15520	39500	45500	6,800	8,900	0.196	
28.575	58.738	19.050	19.355	15.080	1985/1932	40500	44500	6,800	8,900	0.230	
28.575	58.738	19.050	19.355	15.080	1988/1932	40500	44500	6,800	8,900	0.228	



Inch Series

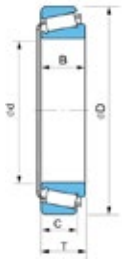

Principal dimensions					Designation	Basic Load Ratings		Speed Ratings		Mass
d	D	T	B	C		Dynamic	Static	Reference speed	Limiting speed	
						C	C ₀			
mm						N	r/min	kg		
28.575	60.325	19.842	17.462	15.875	15590/15523	39500	45500	6,800	8,900	0.250
28.575	60.325	19.845	19.355	15.875	1985/1931	40500	44500	6,800	8,900	0.255
28.575	62.000	19.050	20.638	14.288	15112/15245	46500	54000	6,200	8,200	0.277
28.575	62.000	19.050	20.638	14.288	15113/15245	46500	54000	6,200	8,200	0.280
28.575	64.292	21.433	21.433	16.670	86647/866610	51500	64500	6,100	8,100	0.348
28.575	66.421	23.812	25.433	19.050	2689/2631	64500	72500	6,200	8,200	0.416
28.575	68.262	22.225	22.225	17.462	02474/02420	57000	67000	5,900	7,700	0.409
28.575	68.262	22.225	23.812	17.462	2474/2420	57500	65500	5,900	7,700	0.410
28.575	69.850	23.812	25.357	19.050	2578/2523	69000	81500	5,800	7,600	0.483
28.575	72.626	24.608	24.257	17.462	41125/41286	58000	55500	5,900	7,700	0.477
28.575	72.626	24.608	24.257	17.462	41126/41286	58000	55500	5,900	7,700	0.481
28.575	73.025	22.225	22.225	17.462	02872/02820	56500	68000	5,300	7,000	0.480
29.000	50.292	14.224	14.732	10.668	45449/45410	28000	35500	7,300	9,600	0.113
29.367	66.421	23.812	25.433	19.050	2690/2631	64500	72500	6,200	8,200	0.406
29.987	62.000	16.002	16.566	14.288	17118/17244	39000	42000	6,400	8,400	0.228
29.987	62.000	19.050	20.638	14.288	15117/15245	46500	54000	6,300	8,200	0.269
30.000	69.012	19.845	19.583	15.875	14117A/14276	48500	58000	5,600	7,400	0.369

Inch Series

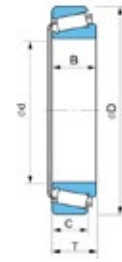

Principal dimensions					Designation	Basic Load Ratings		Speed Ratings		Mass
d	D	T	B	C		Dynamic	Static	Reference speed	Limiting speed	
						C	C ₀			
mm						N	r/min	kg		
30.000	72.000	29.370	27.783	23.020	88540/88513	72000	97000	5,400	7,100	0.619
30.112	62.000	19.050	20.638	14.288	15116/15245	46500	54000	6,200	8,200	0.268
30.162	62.000	16.002	16.566	14.288	17119/17244	39000	42000	6,400	8,400	0.226
30.162	64.292	21.433	21.433	16.670	86649/86610	51500	64500	6,200	8,100	0.336
30.162	69.850	23.812	25.357	19.050	2558/2523	69000	81500	5,800	7,600	0.468
30.162	72.626	30.162	29.997	23.812	3187/3120	84500	98000	5,500	7,300	0.621
30.213	62.000	19.050	20.638	14.288	15118/15245	46500	54000	6,200	8,200	0.265
30.213	62.000	19.050	20.638	14.288	15119/15245	46500	54000	6,200	8,200	0.267
30.213	62.000	19.050	20.638	14.288	15120/15245	46500	54000	6,200	8,200	0.267
30.226	69.012	19.845	19.583	15.875	14116/14274	48500	58000	5,600	7,400	0.366
30.226	69.012	19.845	19.583	15.875	14116/14276	48500	58000	5,600	7,400	0.370
30.226	72.085	22.385	19.583	18.415	14116/14283	48500	58000	5,600	7,400	0.447
31.750	59.131	15.875	16.764	11.811	67048/67010	34500	41000	6,400	8,400	0.182
31.750	62.000	18.161	19.050	14.288	15123/15245	46500	54000	6,200	8,200	0.244
31.750	62.000	19.050	20.638	14.288	15125/15245	46500	54000	6,200	8,200	0.253
31.750	62.000	19.050	20.638	14.288	15126/15245	46500	54000	6,200	8,200	0.255



Inch Series

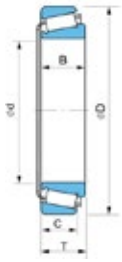

Principal dimensions					Designation	Basic Load Ratings		Speed Ratings		Mass
d	D	T	B	C		Dynamic	Static	Reference	Limiting	
mm						C	C ₀	speed	speed	
						N		r/min		
31.750	66.421	25.400	25.357	20.638	2580/2520	69000	81500	5,800	7,600	0.409
31.750	68.262	22.225	22.225	17.462	02475/02420	57000	67000	5,900	7,700	0.380
31.750	68.262	22.225	22.225	17.462	02476/02420	57000	67000	5,900	7,700	0.383
31.750	69.012	19.845	19.583	15.875	14124/14276	48500	58000	5,700	7,400	0.359
31.750	69.012	19.845	19.583	15.875	14125A/14276	48500	58000	5,700	7,400	0.356
31.750	69.850	23.812	25.357	19.050	2580/2523	69000	81500	5,800	7,600	0.454
31.750	69.850	23.812	25.357	19.050	2580/2523S	69000	81500	5,800	7,600	0.453
31.750	69.850	23.812	25.357	19.050	2582/02523	69000	81500	5,800	7,600	0.451
31.750	72.626	30.162	29.997	23.812	3188/3120	84500	98000	5,600	7,300	0.603
31.750	72.626	30.162	29.997	23.812	3193/3120	84500	98000	5,600	7,300	0.601
31.750	73.025	22.225	22.225	17.462	02875/02820	56500	68000	5,400	7,000	0.451
31.750	73.025	22.225	23.812	17.462	2879/2820	62500	75500	5,400	7,000	0.465
31.750	73.025	29.370	27.783	23.020	88542/88510	72000	97000	5,400	7,100	0.622
31.750	73.025	29.370	27.783	23.020	88542/88511	72000	97000	5,400	7,100	0.626
31.750	73.812	29.370	27.783	23.020	88542/88512	72000	97000	5,400	7,100	0.638
31.750	76.200	29.370	28.575	23.020	89440/89410	78000	105000	5,200	6,800	0.686
31.750	79.375	29.370	29.771	23.812	3476/3420	93000	114000	5,100	6,600	0.767
33.338	68.262	22.225	22.225	14.462	88048/88010	56500	71000	5,700	7,500	0.378

Inch Series

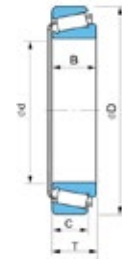

Principal dimensions					Designation	Basic Load Ratings		Speed Ratings		Mass
d	D	T	B	C		Dynamic	Static	Reference	Limiting	
mm						C	C ₀	speed	speed	
						N		r/min		
33.338	69.012	19.845	19.583	15.875	14130/14276	48500	58000	5,700	7,400	0.344
33.338	69.012	19.845	19.583	15.875	14131/14276	48500	58000	5,700	7,400	0.346
33.338	69.850	23.812	25.357	19.050	2585/2523	69000	81500	5,800	7,600	0.435
33.338	72.626	30.162	29.997	23.812	3196/3120	84500	98000	5,600	7,300	0.581
33.338	73.025	29.370	27.783	23.020	88547/88510	72000	97000	5,400	7,100	0.604
33.338	76.200	23.812	25.654	19.050	2785/2720	73000	90500	5,200	6,800	0.551
33.338	76.200	23.812	25.654	19.050	2790/2720	73000	90500	5,200	6,800	0.553
33.338	76.200	29.370	28.575	23.020	89443/89410	78000	105000	5,200	6,800	0.668
33.338	76.200	29.370	28.575	23.020	89444/89410	78000	105000	5,200	6,800	0.665
33.338	49.375	25.400	24.074	17.462	43131/43312	65500	67000	4,800	6,200	0.568
34.925	65.088	18.034	18.288	13.970	48548/48510	46500	56000	5,800	7,600	0.249
34.925	65.088	18.034	18.288	13.970	48548A/48510	46500	56000	5,800	7,600	0.252
34.925	69.012	19.845	19.583	15.875	14137A/14276	48500	58000	5,700	7,400	0.333
34.925	69.012	19.845	19.583	15.875	14138A/14276	48500	58000	5,700	7,400	0.331
34.925	72.233	25.400	25.400	19.842	88649/88610	65000	84500	5,500	7,200	0.849
34.925	72.238	20.638	20.638	15.875	16137/16284	48000	58500	5,400	7,000	0.385
34.925	73.025	22.225	22.225	17.462	02877/02820	56500	68000	5,400	7,000	0.422
34.925	73.025	22.225	22.225	17.462	02878/02820	56500	68000	5,400	7,000	0.425



Inch Series

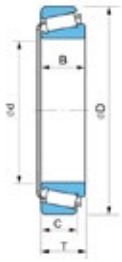

Principal dimensions					Designation	Basic Load Ratings		Speed Ratings		Mass
d	D	T	B	C		Dynamic	Static	Reference	Limiting	
						C	C ₀	speed	speed	
mm						N		r/min		
34.925	73.025	22.225	22.812	17.462	2878/2820	62500	75500	5,400	7,000	0.434
34.925	73.025	23.812	24.608	19.050	25877/25820	71000	85000	5,400	7,100	0.471
34.925	73.025	23.812	24.608	19.050	25877/25821	71000	85000	5,400	7,100	0.474
34.925	73.025	23.812	24.608	19.050	25878/25821	71000	85000	5,400	7,100	0.471
34.925	73.025	23.812	25.654	19.050	2793/2735X	73000	90500	5,200	6,800	0.485
34.925	76.200	23.812	25.654	19.050	2793/2720	73000	90500	5,200	6,800	0.536
34.925	76.200	23.812	25.654	19.050	2793/2729	73000	90500	5,200	6,800	0.541
34.925	76.200	23.812	25.654	19.050	2796/2720	73000	90500	5,200	6,800	0.533
34.925	76.200	29.370	28.575	23.020	89446/89410	78000	105000	5,200	6,800	0.646
34.925	76.200	29.370	28.575	23.812	31593/31520	80500	97000	5,200	6,800	0.625
34.925	76.200	29.370	58.575	23.812	31594/31520	80500	97000	5,200	6,800	0.627
34.925	76.200	29.370	28.575	23.812	31594/31521	80500	97000	5,200	6,800	0.631
34.925	79.375	29.370	29.771	23.812	3478/3420	93000	114000	5,100	6,600	0.725
34.925	80.167	29.370	30.391	23.812	3379/3320	95000	112000	4,900	6,400	0.732
34.925	85.725	30.162	30.162	23.812	3872/3820	105000	132000	4,600	6,000	0.897
34.976	69.012	19.845	19.583	15.875	14139/14276	48500	58000	5,700	7,400	0.333
34.988	59.974	15.875	16.764	11.938	68149/68111	35500	47500	6,200	8,100	0.179

Inch Series

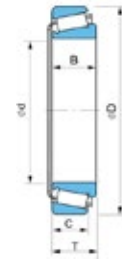

Principal dimensions					Designation	Basic Load Ratings		Speed Ratings		Mass
d	D	T	B	C		Dynamic	Static	Reference	Limiting	
						C	C ₀	speed	speed	
mm						N		r/min		
34.988	61.973	16.700	17.000	13.600	78349A/78310A	37000	48000	6,100	7,900	0.209
34.988	61.973	18.000	17.000	15.000	78349/78310 C	37000	48000	6,100	7,900	0.218
35.000	70.000	24.000	23.500	19.000	3549A/3510	62000	48000	5,600	7,300	0.420
35.000	79.375	23.812	25.400	19.050	26883/26822	76500	97500	4,900	6,400	0.610
35.000	80.000	21.000	22.403	14.826	339/332	68000	75000	4,800	6,300	0.534
35.717	72.233	25.400	25.400	19.842	88648/88610	65000	84500	5,500	7,200	0.478
35.717	72.626	25.400	25.400	19.842	88648/88611AS	65000	84500	5,500	7,200	0.482
36.487	76.200	23.812	25.654	19.050	25880/25821	71000	85000	5,400	7,100	0.457
36.487	76.200	23.812	25.654	19.050	2780/2720	73000	90500	5,200	6,800	0.518
36.487	76.200	29.370	28.575	23.020	2794/2720	73000	90500	5,200	6,800	0.516
36.512	76.200	29.370	28.575	23.020	89448/89410	78000	105000	5,200	6,800	0.629
36.512	76.200	29.370	28.575	23.020	89449/89410	78000	105000	5,200	6,800	0.626
36.512	76.200	29.370	28.575	23.812	89449/89411	78000	105000	5,200	6,800	0.631
36.512	73.200	29.370	28.575	23.812	31597/31520	80500	97000	5,200	6,800	0.605
36.512	79.375	38.370	28.829	22.664	89249/89210	86500	104000	5,100	6,600	0.686
36.512	79.375	29.370	29.771	23.812	3479/3420	93000	114000	5,100	6,600	0.707
36.512	88.500	25.400	23.698	17.462	44143/44348	70500	78000	4,100	5,300	0.729



Inch Series

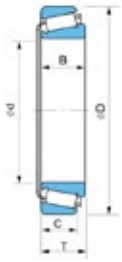

Principal dimensions					Designation	Basic Load Ratings		Speed Ratings		Mass
d	D	T	B	C		Dynamic	Static	Reference speed	Limiting speed	
mm						C	C ₀			
mm						N		r/min		
38.000	63.000	17.000	17.000	13.500	69349/69310	38500	52500	5,800	7,600	0.198
38.100	63.500	12.700	11.908	9.525	13889/13830	25900	33500	5,600	7,300	0.147
38.100	65.088	18.034	18.288	13.970	29748/29710	43500	57000	5,700	7,400	0.233
38.100	65.088	18.034	18.288	13.970	29749/29710	43500	57000	5,700	7,400	0.235
38.100	65.088	19.812	18.288	15.748	29749/29711	43500	57000	5,700	7,400	0.250
38.100	69.012	19.050	19.050	15.083	13685/13621	47500	59500	5,400	7,100	0.293
38.100	69.012	19.050	19.050	15.083	13687/13620	47500	59500	5,400	7,100	0.298
38.100	69.012	19.050	19.050	15.083	13687/13621	47500	59500	5,400	7,100	0.296
38.100	71.438	15.875	16.520	11.908	19150/19281	43500	51000	5,500	7,200	0.273
38.100	72.000	17.018	16.520	14.288	19150/19283	43500	51000	5,500	7,200	0.300
38.100	72.000	19.000	20.638	14.237	16150/16282	48000	58500	5,400	7,000	0.331
38.100	72.238	20.638	20.638	15.875	16150/16284	48000	58500	5,400	7,000	0.355
38.100	76.200	20.638	20.940	15.507	28150/28300	55500	63000	5,100	6,700	0.405
38.100	76.200	23.812	25.654	19.050	2776/2720	73000	90500	5,200	6,800	0.495
38.100	76.200	23.812	25.654	19.050	2777/2720	73000	90500	5,200	6,800	0.492
38.100	76.200	23.812	25.654	19.050	2788/2720	73000	90500	5,200	6,800	0.497
38.100	76.200	23.812	25.654	19.050	2788A/2720	73000	90500	5,200	6,800	0.499
38.100	79.375	23.812	25.400	19.050	26878/26822	76500	97500	4,900	6,400	0.574

Inch Series

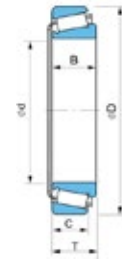

Principal dimensions					Designation	Basic Load Ratings		Speed Ratings		Mass
d	D	T	B	C		Dynamic	Static	Reference speed	Limiting speed	
mm						C	C ₀			
mm						N		r/min		
38.100	79.375	29.370	29.771	23.812	3490/3420	93000	114000	5,100	6,600	0.683
38.100	80.000	21.006	20.940	15.875	28150/28315	55500	63000	5,100	6,700	0.467
38.100	80.035	24.608	23.698	18.512	27880/27820	67000	82500	4,900	6,400	0.562
38.100	80.035	24.608	23.698	18.512	27881/27820	67000	82500	4,900	6,400	0.559
38.100	82.550	29.370	28.575	23.020	801346/801310	87000	117000	4,800	6,200	0.767
38.100	82.931	23.812	25.400	19.050	25572/25520	76000	98000	4,600	6,000	0.645
38.100	85.725	30.162	30.162	23.812	3875/3820	105000	132000	4,600	6,000	0.857
38.100	85.725	30.162	30.162	23.812	3876/3820	105000	132000	4,600	6,000	0.854
38.100	87.312	30.162	30.886	23.812	3580/3525	94000	117000	4,500	5,900	0.881
38.100	88.500	25.400	23.698	17.462	44150/44348	70500	78000	4,100	5,300	0.711
38.100	88.500	26.988	29.083	22.225	418/414	95500	107000	4,700	6,100	0.840
39.688	76.200	23.812	25.654	19.050	2789/2720	73000	90500	5,200	6,800	0.477
39.688	77.534	29.370	30.391	23.812	3382/3321	95000	112000	4,900	6,400	0.669
39.688	79.375	23.812	25.400	19.050	26880/26822	76500	97500	4,900	6,400	0.554
39.688	79.375	23.812	25.400	19.050	26881/26822	76500	97500	4,900	6,400	0.552
39.688	80.035	29.370	30.391	23.812	3382/3339	95000	112000	4,900	6,400	0.666
39.688	80.167	29.370	30.391	23.812	3382/3320	95000	112000	4,900	6,400	0.665
39.688	80.167	29.370	30.391	23.812	3382/3331	95000	112000	4,900	6,400	0.670



Inch Series

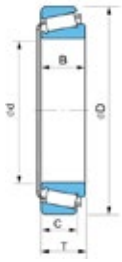

Principal dimensions					Designation	Basic Load Ratings		Speed Ratings		Mass
d	D	T	B	C		Dynamic	Static	Reference	Limiting	
						C	C ₀	speed	speed	
mm						N		r/min		
39.688	80.167	29.370	30.391	23.812	3386/3320	95000	112000	4,900	6,400	0.668
39.688	88.500	25.400	23.698	17.462	44158/44348	70500	78000	4,100	5,300	0.691
40.000	76.200	20.638	20.940	15.507	28158/28300	55500	63000	5,100	6,700	0.386
40.000	80.000	21.000	22.403	14.826	344/332	68000	75000	4,800	6,300	0.479
40.000	80.000	21.000	22.403	17.826	344A/332	68000	75000	4,800	6,300	0.482
40.000	85.000	20.638	21.692	17.462	350A/354A	69500	79500	4,500	5,800	0.562
40.000	88.500	26.988	29.083	22.225	420/414	95500	107000	4,700	6,100	0.813
40.000	107.950	36.512	36.957	28.575	543/532X	141000	177000	3,700	4,800	1.770
40.483	82.550	29.370	28.575	23.020	803149/801310	87000	117000	4,800	6,200	0.731
40.988	67.975	17.500	18.000	13.500	300849/300811	46000	62500	5,400	7,000	0.239
41.275	73.025	16.667	17.462	12.700	18590/18520	46000	55500	5,100	6,600	0.281
41.275	73.431	19.558	19.812	14.732	503149/501310	56000	69500	5,100	6,600	0.335
41.275	73.431	21.430	19.812	16.604	501349/501314	56000	69500	5,100	6,600	0.355
41.275	76.200	18.009	17.384	14.288	11162/11300	42500	51500	5,000	6,500	0.337
41.275	76.200	22.225	23.020	17.462	24780/24720	65000	80500	5,000	6,500	0.432
41.275	76.200	25.400	25.400	20.638	26882/26823	76500	97500	4,900	6,400	0.488
41.275	79.375	23.812	25.400	19.050	26882/26822	76500	97500	4,900	6,400	0.531
41.275	79.375	23.812	25.400	19.050	26882/26822A	76500	97500	4,900	6,400	0.528

Inch Series

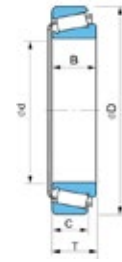

Principal dimensions					Designation	Basic Load Ratings		Speed Ratings		Mass
d	D	T	B	C		Dynamic	Static	Reference	Limiting	
						C	C ₀	speed	speed	
mm						N		r/min		
41.275	79.375	23.812	25.400	19.050	26885/26822	76500	97500	4,900	6,400	0.535
41.275	80.000	18.009	17.384	14.288	11162/11315	42500	51500	5,000	6,500	0.389
41.275	80.000	21.000	22.403	17.826	336/332	68000	75000	4,800	6,300	0.468
41.275	80.000	21.000	22.403	17.826	342/332	68000	75000	4,800	6,300	0.465
41.275	80.000	23.812	25.400	19.050	26882/26824	76500	97500	4,900	6,400	0.542
41.275	80.167	25.400	25.400	20.638	26882/26820	76500	97500	4,900	6,400	0.563
41.275	82.550	26.543	25.654	20.193	802048/802011	80500	104000	4,700	6,100	0.642
41.275	85.725	30.162	30.162	23.812	3880/3820	105000	132000	4,600	6,000	0.810
41.275	87.312	30.162	30.886	23.812	3576/3525	94000	117000	4,500	5,900	0.834
41.275	87.312	30.162	30.886	23.812	3577/3525	94000	117000	4,500	5,900	0.831
41.275	87.312	30.162	30.886	23.812	3585/3525	94000	117000	4,500	5,900	0.833
41.275	88.900	30.162	29.370	23.020	803145/803110	93500	125000	4,500	5,800	0.901
41.275	88.900	30.162	29.370	23.020	803146/803110	93500	125000	4,500	5,800	0.898
41.275	90.488	39.688	40.368	33.338	4388/4335	136000	175000	4,500	5,800	1.250
41.275	92.075	26.195	23.812	16.670	903345/903310	72500	81500	3,800	5,000	0.758
41.275	93.662	31.750	31.750	26.195	46162/46368	103000	131000	4,200	5,500	1.090
41.275	95.250	30.162	29.370	23.020	804840/804810	109000	147000	4,100	5,300	1.080



Inch Series

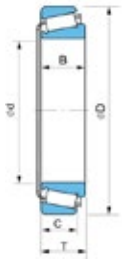

Principal dimensions					Designation	Basic Load Ratings		Speed Ratings		Mass
d	D	T	B	C		Dynamic C	Static C ₀	Reference speed	Limiting speed	
mm						N	r/min	kg		
41.275	95.250	30.958	28.300	20.638	53162/53375	82500	92000	3,800	5,000	0.975
41.275	95.250	30.958	28.575	22.225	903245/903210	96000	116000	3,800	4,900	1.050
42.070	90.488	39.688	40.386	33.338	4395/4335	136000	175000	4,500	5,800	1.240
42.862	82.550	26.195	26.988	20.638	22780/22720	75500	97000	4,700	6,100	0.617
42.862	82.931	23.812	25.400	19.050	25578/25520	76000	98000	4,600	6,000	0.584
42.862	87.312	30.162	30.886	23.812	3579/3525	94000	117000	4,500	5,900	0.805
42.875	79.375	23.812	25.400	19.050	26884/26822	76500	97500	4,900	6,400	0.510
42.875	19.375	23.812	25.400	19.050	26886/26822	76500	97500	4,900	6,400	0.513
42.875	82.931	23.812	25.400	19.050	25577/25520	76000	98000	4,600	6,000	0.581
44.450	76.992	17.462	17.145	11.908	12175/12303	44000	54000	4,800	6,300	0.308
44.450	79.375	17.462	17.462	13.495	18685/18620	45500	56000	4,800	6,200	0.345
44.450	82.931	23.812	25.400	19.050	25580/25520	76000	98000	4,600	6,000	0.560
44.450	82.931	23.812	25.400	19.050	25581/25520	76000	98000	4,600	6,000	0.563
44.450	82.931	23.812	25.400	19.050	25582/25520	76000	98000	4,600	6,000	0.556
44.450	84.138	30.162	30.886	23.812	3578/3520	94000	117000	4,500	5,900	0.699
44.450	85.000	20.638	21.692	17.462	355/354A	69500	79500	4,500	5,800	0.511
44.450	85.000	20.638	21.692	17.462	355A/354A	69500	79500	4,500	5,800	0.512
44.450	87.312	30.162	30.886	23.812	3578/3525	94000	117000	4,500	5,900	0.779

Inch Series

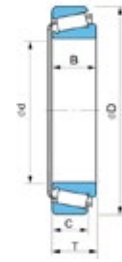

Principal dimensions					Designation	Basic Load Ratings		Speed Ratings		Mass
d	D	T	B	C		Dynamic C	Static C ₀	Reference speed	Limiting speed	
mm						N	r/min	kg		
44.450	87.312	30.162	30.886	23.812	3578/3526	94000	117000	4,500	5,900	0.784
44.450	88.900	30.162	29.370	23.020	803149/803110	93500	125000	4,500	5,800	0.849
44.450	93.264	30.162	30.302	23.812	3782/3720	102000	134000	4,100	5,300	0.961
44.450	93.662	31.750	31.750	26.195	46175/46368	103000	131000	4,200	5,500	1.040
44.450	93.662	31.750	31.750	26.195	46176/46368	103000	131000	4,200	5,500	1.030
44.450	95.250	27.783	28.575	22.225	33885/33821	107000	139000	4,000	5,200	0.987
44.450	95.250	27.273	29.900	22.225	438/432	108000	129000	4,300	5,600	0.953
44.450	95.250	27.783	29.900	22.225	438/432A	108000	129000	4,300	5,600	0.953
44.450	95.250	30.162	29.370	23.020	804842/804810	109000	147000	4,100	5,300	1.040
44.450	95.250	30.958	28.300	20.638	53176/53375	82500	92000	3,800	5,000	0.928
44.450	95.250	30.958	28.300	20.638	53176/53377	82500	92000	3,800	5,000	0.924
44.450	95.250	30.958	28.300	20.638	53177/53375	82500	92000	3,800	5,000	0.925
44.450	95.250	30.958	28.300	20.638	53178/53375	82500	92000	3,800	5,000	0.927
44.450	95.250	30.958	28.300	22.225	903249A/903210	96000	116000	3,800	4,900	0.999
44.450	95.250	30.958	28.575	22.225	903249/903210	96000	116000	3,800	4,900	1.000
44.450	101.600	34.925	36.068	26.988	527/522	135000	165000	3,800	5,000	1.370
44.450	104.775	30.162	29.317	24.605	460/453X	115000	148000	3,600	4,700	1.290



Inch Series

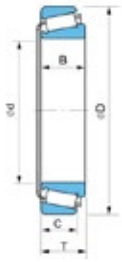

Principal dimensions					Designation	Basic Load Ratings		Speed Ratings		Mass
d	D	T	B	C		Dynamic	Static	Reference speed	Limiting speed	
mm						C	C ₀	r/min	r/min	
44.450	104.775	30.162	30.958	23.812	45280/45220	130000	169000	3,600	4,700	1.350
44.450	104.775	36.512	36.512	28.575	807040/807010	138000	189000	3,700	4,800	1.620
44.450	111.125	30.162	26.909	20.638	55175C/55437	104000	136000	3,200	4,200	1.450
44.450	111.125	30.162	26.909	20.638	55176C/55437	104000	136000	3,200	4,200	1.090
44.450	127.000	50.800	52.388	41.275	6277/6220	250000	320000	3,300	4,300	3.580
44.983	82.931	23.812	25.400	19.050	25584/25520	76000	98000	4,600	6,000	0.555
44.983	93.264	30.162	30.302	23.812	3776/3720	102000	134000	4,100	5,300	0.952
45.000	85.000	20.638	21.692	17.462	358/354A	69500	79500	4,500	5,800	0.505
45.000	88.900	20.638	22.225	16.513	367/362A	76500	90500	4,200	5,500	0.595
45.237	87.312	30.162	30.886	23.812	3586/3525	94000	117000	4,500	5,900	0.765
45.242	73.431	19.558	19.812	15.748	102949/102910	54000	76000	4,900	6,400	0.307
45.242	77.788	19.842	19.842	15.080	603049/603011	57500	73500	4,800	6,200	0.372
45.242	77.788	21.430	19.842	16.667	603049/603012	57500	73500	4,800	6,200	0.391
45.242	79.974	19.842	19.842	15.080	603049/603014	57500	73500	4,800	6,200	0.405
45.618	82.550	23.812	25.400	19.050	25590/25519	76000	98000	4,600	6,000	0.534
45.618	82.931	23.812	25.400	19.050	25590/25520	76000	98000	4,600	6,000	0.543
45.618	82.931	26.988	25.400	22.225	25590/25523	76000	98000	4,600	6,000	0.588

Inch Series

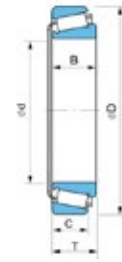

Principal dimensions					Designation	Basic Load Ratings		Speed Ratings		Mass
d	D	T	B	C		Dynamic	Static	Reference speed	Limiting speed	
mm						C	C ₀	r/min	r/min	
45.618	83.058	23.812	25.400	19.050	25590/25521	76000	98000	4,600	6,000	0.541
45.618	83.058	23.876	25.400	19.114	25590/25522	76000	98000	4,600	6,000	0.545
45.618	85.000	23.812	25.400	19.050	25590/25526	76000	98000	4,600	6,000	0.581
45.987	74.976	18.000	18.000	14.000	503349A/503310	51000	71000	4,800	6,300	0.296
46.038	79.375	17.462	17.462	13.495	18690/18620	45500	56000	4,800	6,200	0.329
46.038	82.931	23.812	25.400	19.050	25592/25520	76000	98000	4,600	6,000	0.538
46.038	85.000	20.638	21.692	17.462	359A/354A	69500	79500	4,500	5,800	0.489
46.038	85.000	20.638	21.692	17.462	359S/254A	69500	79500	4,500	5,800	0.491
46.038	85.000	25.400	25.607	20.638	2984/2924	79000	104000	4,500	5,800	0.615
46.038	90.119	23.000	21.692	21.808	359S/352	69500	79500	4,500	5,800	0.651
46.038	93.264	30.162	30.302	23.812	3777/3720	102000	134000	4,100	5,300	0.934
46.038	95.250	27.783	29.900	22.225	436/432	108000	129000	4,300	5,600	0.927
47.625	88.900	20.638	22.225	16.513	369A/362A	76500	90500	4,200	5,500	0.559
47.625	88.900	20.638	22.225	16.513	369S/392A	76500	90500	4,200	5,500	0.561
47.625	88.900	25.400	25.400	19.050	804048/804010	82000	101000	4,300	5,600	0.662
47.625	88.900	25.400	25.400	19.050	804049/804010	82000	101000	4,300	5,600	0.657
47.625	93.264	30.162	30.302	23.812	3778/3720	102000	134000	4,100	5,300	0.898



Inch Series

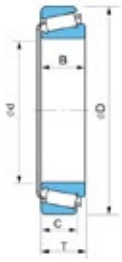

Principal dimensions					Designation	Basic Load Ratings		Speed Ratings		Mass
d	D	T	B	C		Dynamic	Static	Reference	Limiting	
mm						C	C ₀	speed	speed	
						N		r/min		kg
47.625	93.264	30.162	30.302	23.812	3779/3720	102000	134000	4,100	5,300	0.906
47.625	95.250	30.162	29.370	23.020	804846/804810	109000	147000	4,100	5,300	0.978
47.625	96.838	21.000	21.946	15.875	386A/382A	78000	96500	3,800	5,000	0.720
47.625	101.600	34.925	36.068	26.988	528/522	135000	165000	3,800	5,000	1.300
47.625	104.775	30.162	29.317	24.605	463/453X	115000	148000	3,600	4,700	1.240
47.625	104.775	30.162	29.317	24.605	467/453X	115000	148000	3,600	4,700	1.240
47.625	104.775	30.162	30.958	23.812	45282/45220	130000	169000	3,600	4,700	1.290
47.625	111.125	30.162	26.909	20.638	55187C/55437	104000	136000	3,200	4,200	1.400
47.625	123.825	36.512	32.791	25.400	72188C/72487	154000	188000	3,000	3,900	2.160
48.412	95.250	30.162	29.370	23.020	804848/804810	109000	147000	4,100	5,300	0.967
48.412	95.250	30.162	29.370	23.020	804849/804810	109000	147000	4,100	5,300	0.964
49.212	93.264	30.162	30.302	23.812	3781/3720	102000	134000	4,100	5,300	0.877
49.212	103.188	43.658	44.475	36.512	5395/5335	174000	232000	3,800	5,000	1.750
49.212	104.775	36.512	36.512	28.575	807044/807010	138000	189000	3,700	4,800	1.520
49.212	114.300	44.450	44.450	34.925	65390/65320	186000	225000	3,700	4,800	2.230
49.212	114.300	44.500	44.500	36.068	506348/506310	203000	261000	3,600	4,700	2.330
49.987	82.550	21.590	22.250	16.510	104947A/104911	69500	94000	4,400	5,700	0.434
49.987	89.980	24.750	25.400	19.987	28579/28520	83500	116000	4,100	5,300	0.670

Inch Series

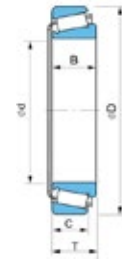

Principal dimensions					Designation	Basic Load Ratings		Speed Ratings		Mass
d	D	T	B	C		Dynamic	Static	Reference	Limiting	
mm						C	C ₀	speed	speed	
						N		r/min		kg
49.987	92.075	24.608	25.400	19.845	28579/28521	83500	116000	4,100	5,300	0.718
49.987	114.300	44.450	44.450	36.068	506349/506310	203000	261000	3,600	4,700	2.270
50.000	82.000	21.500	21.500	17.000	104948/104910	69500	94000	4,400	5,700	0.420
50.000	84.000	22.000	22.000	17.500	704649/704610	69500	94500	4,400	5,700	0.466
50.000	88.900	20.638	22.225	16.513	365/362A	76500	90500	4,200	5,500	0.530
50.000	88.900	20.638	22.225	16.513	366/362A	76500	90500	4,200	5,500	0.529
50.000	90.000	28.000	28.000	23.000	205149/205110	106000	141000	4,200	5,400	0.752
50.000	90.000	28.000	28.000	23.000	205149A/205110	106000	141000	4,200	5,400	0.747
50.000	105.000	37.000	36.000	29.000	807045/807012	138000	189000	3,700	4,800	1.520
50.000	110.000	22.000	21.996	18.824	396/394A	89500	120000	3,300	4,300	1.060
50.800	82.550	21.590	22.225	16.510	104949/104911	69500	94000	4,400	5,700	0.419
50.800	82.931	21.590	22.225	16.510	104949/104912	69500	94000	4,400	5,700	0.415
50.800	85.000	17.462	17.462	13.495	18790/18720	49500	65000	4,300	5,600	0.374
50.800	88.900	17.462	17.462	13.495	18790/18724	49500	65000	4,200	5,500	0.431
50.800	88.900	20.638	22.225	16.513	368/362A	49500	90500	4,200	5,500	0.519
50.800	88.900	20.638	22.225	16.513	368A/362A	76500	90500	4,200	5,500	0.516
50.800	88.900	20.638	22.225	16.513	370A/362A	76500	90500	4,200	5,500	0.511



Inch Series

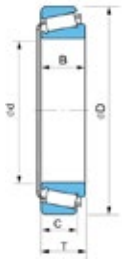

Principal dimensions					Designation	Basic Load Ratings		Speed Ratings		Mass
d	D	T	B	C		Dynamic	Static	Reference speed	Limiting speed	
mm						C	C ₀	speed	speed	
						N		r/min		kg
50.800	90.000	20.000	22.225	15.875	368A/362	76500	90500	4,200	5,500	0.525
50.800	90.000	20.000	22.225	20.000	368A/363	76500	90500	4,200	5,500	0.556
50.800	92.075	24.608	25.400	19.845	28580/28521	83500	116000	4,100	5,300	0.703
50.800	93.264	30.162	30.302	23.812	3775/3720	102000	134000	4,100	5,300	0.852
50.800	93.264	30.162	30.302	23.812	3780/3720	102000	134000	4,100	5,300	0.848
50.800	93.264	30.162	30.302	23.812	3780/3730	102000	134000	4,100	5,300	0.854
50.800	93.264	30.162	30.302	23.812	3784/3720	102000	134000	4,100	5,300	0.839
50.800	95.250	27.783	28.575	22.225	33889/33821	107000	139000	4,000	5,200	0.876
50.800	95.250	30.162	30.302	23.812	3780/3726	102000	134000	4,100	5,300	0.903
50.800	96.838	21.000	21.946	15.875	385A/382A	78000	96500	3,800	5,000	0.676
50.800	97.630	24.608	24.608	19.446	28678/28622	88500	128000	3,800	4,900	0.852
50.800	98.425	30.162	30.302	23.812	3780/3732	102000	134000	4,100	5,300	0.993
50.800	101.600	31.750	31.750	25.400	49585/49520	110000	136000	3,800	5,000	1.130
50.800	101.600	34.925	36.068	26.988	529/522	135000	165000	3,800	5,000	1.240
50.800	101.600	34.925	36.068	26.988	529X/522	135000	165000	3,800	5,000	1.230
50.800	104.775	30.162	29.317	24.605	455/453X	115000	148000	3,600	4,700	1.190
50.800	104.775	30.162	29.317	24.605	455S/453X	115000	148000	3,600	4,700	1.180
50.800	104.775	30.162	30.958	23.812	45284/45220	130000	169000	3,600	4,700	1.220

Inch Series

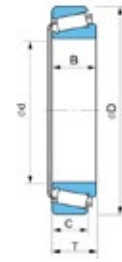

Principal dimensions					Designation	Basic Load Ratings		Speed Ratings		Mass
d	D	T	B	C		Dynamic	Static	Reference speed	Limiting speed	
mm						C	C ₀	speed	speed	
						N		r/min		kg
50.800	104.775	30.162	30.958	23.812	45285/45220	130000	169000	3,600	4,700	1.230
50.800	104.775	30.162	30.958	23.812	45285A/45220	130000	169000	3,600	4,700	1.230
50.800	104.775	36.512	36.512	28.575	807046/807010	138000	189000	3,700	4,800	1.490
50.800	104.775	36.512	36.512	28.575	59200/59412	143000	178000	3,800	4,900	1.440
50.800	107.950	36.512	36.957	28.575	537/532X	141000	177000	3,700	4,800	1.550
50.800	111.125	30.162	28.575	20.638	907643/907614	104000	136000	3,200	4,200	1.360
50.800	112.712	30.162	26.909	20.638	55200C/55443	104000	136000	3,200	4,200	1.340
50.800	112.712	30.162	30.048	23.812	3975/3920	119000	174000	3,300	4,300	1.530
50.800	112.712	30.162	30.162	23.812	39573/39520	138000	195000	3,200	4,200	1.550
50.800	112.712	30.162	30.162	23.812	39575/39520	138000	195000	3,200	4,200	1.540
50.800	117.475	33.338	31.750	23.812	66200/66462	130000	153000	3,400	4,400	1.670
50.800	120.650	41.275	41.275	31.750	619/612	172000	213000	3,400	4,400	2.300
50.800	123.825	36.512	32.791	25.400	72200C/72487	154000	188000	3,000	3,900	2.100
50.800	123.825	36.512	32.791	25.400	72201C/72487	154000	188000	3,000	3,900	2.100
50.800	123.825	38.100	36.678	30.162	555/552A	158000	216000	3,200	4,100	2.340
51.592	88.900	20.638	22.225	16.513	368S/362A	76500	90500	4,200	5,500	0.507
52.388	92.075	24.608	25.400	19.845	28584/28521	83500	116000	4,100	5,300	0.677
52.388	93.264	30.162	30.302	23.812	3767/3720	102000	134000	4,100	5,300	0.819



Inch Series

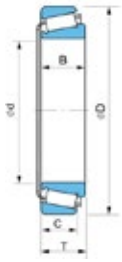

Principal dimensions					Designation	Basic Load Ratings		Speed Ratings		Mass
d	D	T	B	C		Dynamic	Static	Reference	Limiting	
mm						C	C ₀	speed	speed	
						N		r/min		kg
52.388	95.250	27.783	28.575	22.225	33890/33821	107000	139000	4,000	5,200	0.851
52.388	95.250	27.783	28.575	22.225	33891/33821	107000	139000	4,000	5,200	0.847
53.975	88.900	19.050	19.050	13.492	806649/806610	61000	82500	4,100	5,300	0.437
53.975	95.250	27.783	28.575	22.225	33895/33821	107000	139000	4,000	5,200	0.821
53.975	95.250	27.783	28.575	22.225	33895/33822	107000	139000	4,000	5,200	0.824
53.975	96.838	21.000	21.946	15.875	389A/382A	78000	96500	3,800	5,000	0.633
53.975	104.775	30.162	30.958	23.812	45287/45220	130000	169000	3,600	4,700	1.170
53.975	104.775	36.512	36.512	28.575	807049/807010	138000	189000	3,700	4,800	1.410
53.975	107.950	36.512	36.957	28.575	539/532X	141000	177000	3,700	4,800	1.470
53.975	107.950	36.512	36.957	28.575	539A/532A	141000	177000	3,700	4,800	1.470
53.975	111.125	38.100	36.957	30.162	539/532A	141000	177000	3,700	4,800	1.650
53.975	120.650	41.275	41.275	31.750	621/612	172000	213000	3,400	4,400	2.210
53.975	122.238	33.338	31.750	23.812	66584/66520	134000	163000	3,200	4,200	1.790
53.975	122.238	43.658	43.764	36.512	5578/5535	194000	283000	3,200	4,100	2.640
53.975	123.825	36.512	32.791	25.400	72212C/72487	154000	188000	3,000	3,900	2.030
53.975	123.825	38.100	36.678	30.162	557S/552A	158000	216000	3,200	4,100	2.260
53.975	130.175	36.512	33.338	23.812	911242/911210	156000	186000	2,800	3,600	2.270
53.975	140.030	36.512	33.236	23.520	78214C/78551	171000	212000	2,600	3,400	2.770

Inch Series

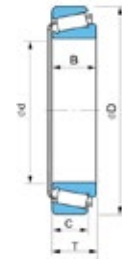

Principal dimensions					Designation	Basic Load Ratings		Speed Ratings		Mass
d	D	T	B	C		Dynamic	Static	Reference	Limiting	
mm						C	C ₀	speed	speed	
						N		r/min		kg
53.975	140.030	36.512	33.236	23.520	78215C/78551	171000	212000	2,600	3,400	2.760
54.448	104.775	36.512	36.512	28.575	807048/807010	138000	189000	3,700	4,800	1.400
55.000	90.000	23.000	23.000	18.500	506849/506810	77500	109000	4,100	5,300	0.558
55.000	95.000	29.000	29.000	23.500	207049/207010	107000	144000	3,900	5,100	0.820
55.000	95.000	29.000	29.000	23.500	207049A/207010	107000	144000	3,900	5,100	0.809
55.000	96.838	21.000	21.946	15.875	385/382A	78000	96500	3,800	5,000	0.616
55.000	96.838	21.000	21.946	15.875	385X/382A	78000	96500	3,800	5,000	0.614
55.000	110.000	29.000	39.000	32.000	307749/307710	173000	219000	3,500	4,600	1.710
55.562	97.630	24.608	24.608	19.446	28680/28622	88500	128000	3,800	4,900	0.774
55.562	123.825	36.512	32.791	25.400	72218C/72487	154000	188000	3,000	3,900	1.990
55.562	127.000	36.512	36.512	26.988	813840/813810	163000	228000	2,900	3,800	2.340
55.575	96.838	21.000	21.946	15.875	389/382A	78000	96500	3,800	5,000	0.608
57.150	96.838	21.000	21.946	15.875	387/382A	78000	96500	3,800	5,000	0.583
57.150	96.838	21.000	21.946	15.875	387A/382A	78000	96500	3,800	5,000	0.581
57.150	96.838	21.000	21.946	15.875	387AS/382A	78000	96500	3,800	5,000	0.576
57.150	96.838	21.000	21.946	15.875	387S/382A	78000	96500	3,800	5,000	0.585
57.150	96.838	25.400	21.946	20.274	387A/382S	78000	96500	3,800	5,000	0.650



Inch Series

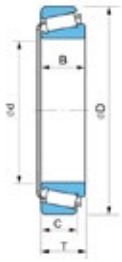

Principal dimensions					Designation	Basic Load Ratings		Speed Ratings		Mass
d	D	T	B	C		Dynamic	Static	Reference speed	Limiting speed	
mm						C	C ₀	speed	speed	
						N		r/min		kg
57.150	97.630	24.608	24.608	19.446	28682/28622	88500	128000	3,800	4,900	0.747
57.150	98.425	21.000	21.946	17.826	387A/382	78000	96500	3,800	5,000	0.628
57.150	100.000	21.000	21.946	17.826	387A/383A	78000	96500	3,800	5,000	0.660
57.150	104.775	30.162	29.317	24.605	462/453X	115000	148000	3,600	4,700	1.060
57.150	104.775	30.162	29.317	24.605	469/453X	115000	148000	3,600	4,700	1.060
57.150	104.775	30.162	30.958	23.812	45289/45220	130000	169000	3,600	4,700	1.100
57.150	104.775	30.162	30.958	23.812	45290/45220	130000	169000	3,600	4,700	1.100
57.150	104.775	30.162	30.958	23.812	45291/45220	130000	169000	3,600	4,700	1.090
57.150	107.950	27.783	29.317	22.225	469/453A	115000	148000	3,600	4,700	1.110
57.150	110.000	22.000	21.996	18.824	390/394A	89000	120000	3,300	4,300	0.954
57.150	110.000	27.795	29.317	27.000	469/454	115000	148000	3,600	4,700	1.240
57.150	112.712	30.162	30.048	23.812	3979/3920	119000	174000	3,300	4,300	1.400
57.150	112.712	30.162	30.162	23.812	39580/39520	138000	195000	3,200	4,200	1.410
57.150	112.712	30.162	30.162	23.812	39581/39520	138000	195000	3,200	4,200	1.400
57.150	117.475	30.162	30.162	23.812	33225/33462	117000	175000	3,100	4,000	1.580
57.150	117.475	33.338	31.750	23.812	66225/66462	130000	153000	3,400	4,400	1.540
57.150	120.650	41.275	41.275	31.750	623/612	172000	213000	3,400	4,400	2.120
57.150	123.825	36.512	32.791	25.400	72225C/2487	154000	188000	3,000	3,900	1.960

Inch Series

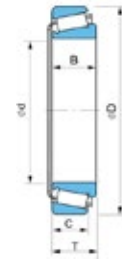

Principal dimensions					Designation	Basic Load Ratings		Speed Ratings		Mass
d	D	T	B	C		Dynamic	Static	Reference speed	Limiting speed	
mm						C	C ₀	speed	speed	
						N		r/min		kg
57.150	123.825	38.100	36.678	30.162	555S/552A	158000	216000	3,200	4,100	2.180
57.150	140.030	36.512	33.236	23.520	78225/78551	171000	212000	2,600	3,400	2.690
57.531	96.838	21.000	21.946	15.875	388A/382A	78000	96500	3,800	5,000	0.575
59.972	122.238	33.338	31.500	23.812	66589/66520	134000	163000	3,200	4,200	1.660
59.987	146.050	41.275	39.688	25.400	913840/913810	199000	234000	2,500	3,200	3.220
60.000	95.000	24.000	24.000	19.000	508748/508710	83000	122000	3,800	4,900	0.606
60.000	107.950	25.400	25.400	19.050	29580/29520	91500	140000	3,300	4,300	0.992
60.000	107.950	25.400	25.400	19.050	29582/29520	91500	140000	3,300	4,300	0.997
60.000	110.000	22.000	21.996	18.824	397/394A	89500	120000	3,300	4,300	0.910
60.000	130.000	34.100	30.924	22.650	911244/911211	156000	186000	2,800	3,600	2.010
60.325	99.979	24.605	25.400	19.050	28985/28919	90500	134000	3,600	4,700	0.762
60.325	100.000	25.400	25.400	19.845	28985/28921	90500	134000	3,600	4,700	0.772
60.325	101.600	25.400	25.400	19.845	28985/28920	90500	134000	3,600	4,700	0.811
60.325	112.712	30.162	30.048	23.812	3980/3920	119000	174000	3,300	4,300	1.330
60.325	122.238	38.100	38.354	29.718	212044/212011	187000	244000	3,200	4,100	2.020
60.325	122.238	43.658	43.764	36.512	5583/5535	194000	283000	3,200	4,100	2.440
60.325	123.825	38.100	36.678	30.162	558/552A	158000	216000	3,200	4,100	2.100



Inch Series

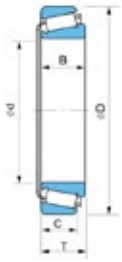

Principal dimensions					Designation	Basic Load Ratings		Speed Ratings		Mass
d	D	T	B	C		Dynamic	Static	Reference speed	Limiting speed	
mm						C	C ₀	speed	speed	
						N		r/min		
60.325	127.000	36.512	36.512	26.988	813841/813810	163000	228000	2,900	3,800	2.210
60.325	127.000	36.512	36.512	26.988	813841A/813810	163000	228000	2,900	3,800	2.200
60.325	127.000	44.450	44.450	34.925	65237/65500	203000	263000	3,200	4,200	2.650
60.325	130.175	36.512	33.338	23.812	911245/911210	156000	186000	2,800	3,600	2.120
60.325	134.983	35.862	33.338	21.948	911245/911216	156000	186000	2,800	3,600	2.250
61.912	110.000	22.000	21.996	18.824	392/394A	89500	120000	3,300	4,300	0.879
61.912	136.525	46.038	46.038	36.512	715334/715311	224000	355000	2,700	3,500	3.470
61.912	146.050	41.275	39.688	25.400	913842/913810	199000	234000	2,500	3,200	3.170
61.976	101.600	24.608	24.608	19.845	28990/28920	90500	134000	3,600	4,700	0.768
62.738	101.600	25.400	25.400	19.845	28995/28920	90500	134000	3,600	4,700	0.764
63.500	94.458	19.050	19.050	15.083	610549/610510	60500	103000	3,700	4,800	0.449
63.500	107.950	25.400	25.400	19.050	29585/29520	91500	140000	3,300	4,300	0.924
63.500	107.950	25.400	25.400	19.050	29585/29522	91500	140000	3,300	4,300	0.931
63.500	107.950	25.400	25.400	19.050	29586/29520	91500	140000	3,300	4,300	0.929
63.500	110.000	22.000	21.996	18.824	390A/394A	89500	120000	3,300	4,300	0.851
63.500	110.000	22.000	21.996	18.824	390A/394AS	89500	120000	3,300	4,300	0.845
63.500	110.000	22.000	21.996	18.824	395/394A	89500	120000	3,300	4,300	0.847
63.500	110.000	25.400	25.400	19.050	29585/29521	91500	140000	3,300	4,300	0.982

Inch Series

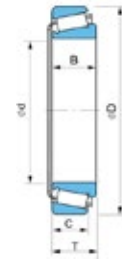

Principal dimensions					Designation	Basic Load Ratings		Speed Ratings		Mass
d	D	T	B	C		Dynamic	Static	Reference speed	Limiting speed	
mm						C	C ₀	speed	speed	
						N		r/min		
63.500	112.712	30.162	30.048	23.812	3982/3920	119000	174000	3,300	4,300	1.260
63.500	112.712	30.162	30.162	23.812	39585/39520	138000	195000	3,200	4,200	1.270
63.500	112.712	30.162	30.162	23.812	39585A/39520	138000	195000	3,200	4,200	1.280
63.500	120.000	29.794	29.007	24.237	477/472	128000	177000	3,100	4,000	1.490
63.500	120.000	29.794	29.007	24.237	483/472	128000	177000	3,100	4,000	1.480
63.500	122.238	38.100	38.354	29.718	212046/212011	187000	244000	3,200	4,100	1.950
63.500	122.238	38.100	38.354	29.718	212047/212011	187000	244000	3,200	4,100	1.940
63.500	122.238	43.658	43.764	36.512	5584/5535	194000	283000	3,200	4,100	2.340
63.500	123.825	38.100	36.678	30.162	559/552A	158000	216000	3,200	4,100	2.010
63.500	127.000	36.512	36.170	28.575	565/563	163000	229000	2,900	3,800	2.110
63.500	127.000	36.512	36.512	26.988	813842/813810	163000	228000	2,900	3,800	2.120
63.500	136.525	41.275	41.275	31.750	639/632	194000	262000	2,900	3,800	2.850
63.500	140.030	36.512	33.236	23.520	78250/78551	171000	212000	2,600	3,400	2.540
65.000	105.000	24.000	23.000	18.500	710949/710910	85000	117000	3,500	4,500	0.742
65.000	110.000	28.000	28.000	22.500	511946/511910	119000	174000	3,300	4,300	1.080
65.000	120.000	39.000	38.500	32.000	211749/211710	185000	248000	3,200	4,100	1.900
65.088	135.755	53.975	56.007	44.450	6379/6320	278000	380000	2,900	3,800	3.710



Inch Series

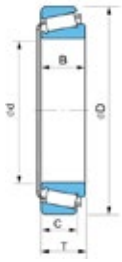

Principal dimensions					Designation	Basic Load Ratings		Speed Ratings		Mass
d	D	T	B	C		Dynamic	Static	Reference speed	Limiting speed	
mm						C	C ₀	speed	speed	
						N		r/min		
66.675	103.213	17.602	17.602	11.989	812148/812111	60000	78000	3,400	4,400	0.480
66.675	107.950	25.400	25.400	19.050	29590/29520	91500	140000	3,300	4,300	0.860
66.675	110.000	22.000	21.996	18.824	395A/394A	89500	120000	3,300	4,300	0.796
66.675	110.000	22.000	21.996	18.824	395S/394A	89500	120000	3,300	4,300	0.791
66.675	112.712	30.162	30.048	23.812	3984/3920	119000	174000	3,300	4,300	1.180
66.675	112.712	30.162	30.048	23.812	3984/3925	119000	174000	3,300	4,300	1.190
66.675	112.712	30.162	30.048	23.812	3994/3920	119000	174000	3,300	4,300	1.180
66.675	112.712	30.162	30.162	23.812	39590/39520	138000	195000	3,200	4,200	1.190
66.675	122.238	38.100	38.354	29.718	212049/212010	187000	244000	3,200	4,100	1.860
66.675	122.238	38.100	38.354	29.718	212049/212011	187000	244000	3,200	4,100	1.850
66.675	123.825	38.100	36.678	30.162	560/552A	158000	216000	3,200	4,100	1.920
66.675	127.000	36.512	36.512	26.988	813844/813810	163000	228000	2,900	3,800	2.030
66.675	130.175	41.275	41.275	31.750	641/633	194000	262000	2,900	3,800	2.410
66.675	135.755	53.975	56.007	44.450	6386/6320	278000	380000	2,900	3,800	3.640
66.675	135.755	53.975	56.007	44.450	6389/6320	278000	380000	2,900	3,800	3.630
66.675	136.525	41.275	41.275	31.750	641/632	194000	262000	2,900	3,800	2.740
66.675	136.525	41.275	41.275	31.750	414242/414210	226000	293000	2,900	3,700	2.750
68.262	110.000	22.000	21.996	18.824	399A/394A	89500	120000	3,300	4,300	0.764

Inch Series

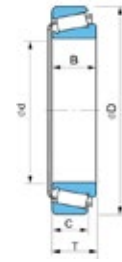

Principal dimensions					Designation	Basic Load Ratings		Speed Ratings		Mass
d	D	T	B	C		Dynamic	Static	Reference speed	Limiting speed	
mm						C	C ₀	speed	speed	
						N		r/min		
68.262	110.000	22.000	21.996	18.824	399AS/394A	89500	120000	3,300	4,300	0.756
68.262	120.000	29.794	29.007	24.237	480/472	128000	177000	3,100	4,000	1.370
68.262	123.825	38.100	36.678	30.162	560S/552A	158000	216000	3,200	4,100	1.870
68.262	136.525	41.275	41.275	31.750	414245/414210	226000	293000	2,900	3,700	2.700
68.262	136.525	46.038	46.038	36.512	715343/715311	224000	355000	2,700	3,500	3.240
69.850	112.712	25.400	25.400	19.050	29675/29620	95500	151000	3,200	4,100	0.949
69.850	117.475	30.162	30.162	23.812	33275/33462	117000	175000	3,100	4,000	1.280
69.850	120.000	29.002	29.007	23.444	482/472A	128000	177000	3,100	4,000	1.300
69.850	120.000	29.794	29.007	24.237	482/472	128000	177000	3,100	4,000	1.330
69.850	120.000	32.545	32.545	26.195	47487/47420	147000	214000	3,100	4,000	1.470
69.850	120.650	25.400	25.400	19.050	29675/29630	95000	151000	3,200	4,100	1.170
69.850	127.000	36.512	36.170	28.575	566/563	163000	229000	2,900	3,800	1.920
69.850	136.525	41.275	41.275	31.750	643/632	194000	262000	2,900	3,800	2.630
69.850	146.050	41.275	41.275	31.750	655/653	206000	295000	2,600	3,300	3.280
69.850	150.089	44.450	46.672	36.512	745A/742	261000	360000	2,500	3,200	3.920
69.850	168.275	53.975	56.363	41.275	835/832	340000	460000	2,300	3,000	6.130
69.952	121.442	24.608	23.012	17.462	34274/34478	91000	127000	2,900	3,800	1.110
69.952	125.052	23.731	23.012	16.400	34274/34492A	91000	127000	2,900	3,800	1.180



Inch Series

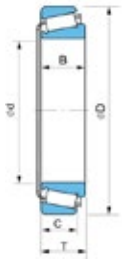

Principal dimensions					Designation	Basic Load Ratings		Speed Ratings		Mass
d	D	T	B	C		Dynamic	Static	Reference speed	Limiting speed	
mm						C	C ₀	r/min	r/min	
70.000	110.000	26.000	25.000	20.500	81349/813010	97000	150000	3,200	4,200	0.889
70.000	115.000	29.000	29.000	23.000	612949/612910	124000	171000	3,200	4,100	1.130
70.000	120.000	29.794	29.007	24.237	484/472	128000	177000	3,100	4,000	1.330
70.000	150.000	41.275	39.688	25.400	913848/913811	199000	234000	2,500	3,200	3.080
71.438	117.475	30.162	30.162	23.812	33281/33462	117000	175000	3,100	4,000	1.240
71.438	120.000	32.545	32.545	26.195	47490/47420	147000	214000	3,100	4,000	1.420
71.438	127.000	36.512	36.170	26.575	567A/563	163000	229000	2,900	3,800	1.870
71.438	136.525	41.275	41.275	31.750	644/632	194000	262000	2,900	3,800	2.570
71.438	136.525	41.275	41.275	31.750	414249/414210	226000	293000	2,900	3,700	2.580
71.438	136.525	46.038	46.038	36.512	715345/715311	224000	355000	2,700	3,500	3.110
73.025	112.712	25.400	25.400	19.050	29685/29620	95500	151000	3,200	4,100	0.873
73.025	117.475	30.162	30.162	23.812	33287/33462	117000	175000	3,100	4,000	1.190
73.025	120.000	29.794	30.162	23.444	33287/33472	117000	175000	3,100	4,000	1.280
73.025	127.000	36.512	36.170	28.575	567/563	163000	229000	2,900	3,800	1.820
73.025	139.992	36.512	36.098	28.575	576/572	178000	265000	2,600	3,400	2.530
73.025	149.225	53.975	54.229	44.450	6460/6420	287000	410000	2,600	3,400	4.420
73.025	150.089	44.450	46.672	36.512	744/742	261000	360000	2,500	3,200	3.790
73.817	112.712	25.400	25.400	19.050	29688/29620	95500	151000	3,200	4,100	0.860
73.817	127.000	36.512	36.170	28.575	568/563	163000	229000	2,900	3,800	1.800
74.612	139.992	36.512	36.098	28.575	577/572	178000	265000	2,600	3,400	2.480
75.000	115.000	25.000	25.000	19.000	714149/714110	94500	143000	3,100	4,000	0.875

Inch Series

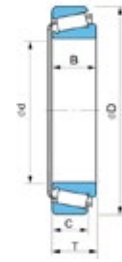

Principal dimensions					Designation	Basic Load Ratings		Speed Ratings		Mass
d	D	T	B	C		Dynamic	Static	Reference speed	Limiting speed	
mm						C	C ₀	r/min	r/min	
75.000	120.000	31.000	29.500	25.000	714249/714210	131000	197000	3,000	3,900	1.290
75.000	145.000	51.000	51.000	42.000	415647/415610	287000	410000	2,600	3,400	3.810
76.200	109.538	19.050	19.050	15.083	814749/814710	63000	115000	3,200	4,100	0.579
76.200	121.442	24.608	23.012	17.462	34300/34478	91000	127000	2,900	3,800	0.982
76.200	121.442	24.608	23.012	17.462	34301/34478	91000	127000	2,900	3,800	0.977
76.200	127.000	30.162	31.000	22.225	42687/42620	135000	194000	2,900	3,700	1.460
76.200	127.000	30.162	31.000	22.225	42688/42620	135000	194000	2,900	3,700	1.440
76.200	133.350	33.338	33.338	26.195	47678/47620	153000	235000	2,700	3,500	1.920
76.200	133.350	33.338	33.338	26.195	47679/47620	153000	235000	2,700	3,500	1.930
76.200	133.350	33.338	33.338	26.195	47680/47620	153000	235000	2,700	3,500	1.940
76.200	133.350	39.688	39.688	32.545	516442/516410	177000	305000	2,700	3,500	2.430
76.200	135.733	44.450	46.100	34.925	5760/5735	211000	330000	2,700	3,500	2.750
76.200	136.525	30.162	29.769	22.225	495A/493	129000	189000	2,700	3,500	1.830
76.200	136.525	30.162	29.769	22.225	495AX/493	129000	189000	2,700	3,500	1.820
76.200	139.992	36.512	36.098	28.575	575/572	178000	265000	2,600	3,400	2.430
76.200	139.992	36.512	36.098	28.575	575S/572	178000	265000	2,600	3,400	2.410
76.200	146.050	41.275	41.275	31.750	659/653	206000	295000	2,600	3,300	3.040
76.200	149.225	53.975	54.229	44.450	6461/6420	287000	410000	2,600	3,400	4.260
76.200	149.225	53.975	54.229	44.450	6461A/6420	287000	410000	2,600	3,400	4.230
76.200	150.089	44.450	46.672	36.512	748S/742	261000	360000	2,500	3,200	3.660
76.200	161.925	53.975	55.100	42.862	6576/6535	310000	460000	2,300	3,000	5.440



Inch Series

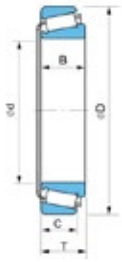

Principal dimensions					Designation	Basic Load Ratings		Speed Ratings		Mass
d	D	T	B	C		Dynamic	Static	Reference speed	Limiting speed	
mm						C	C ₀	reference speed	Limiting speed	
76.200	180.975	53.975	53.183	35.720	917840/917810	325000	415000	2,000	2,600	6.570
76.200	190.500	57.150	57.531	46.038	221430/221410	445000	610000	2,000	2,600	8.690
77.788	117.475	25.400	25.400	19.050	814849/814810	99500	162000	3,000	3,900	0.932
77.788	121.442	24.608	23.012	17.462	34306/34478	91000	127000	2,900	3,800	0.943
77.788	121.442	24.608	23.012	17.462	34307/34478	91000	127000	2,900	3,800	0.930
77.788	127.000	30.162	31.000	22.225	42690/42620	135000	194000	2,900	3,700	1.410
77.788	136.525	30.162	29.769	22.225	495AS/493	129000	189000	2,700	3,500	1.780
77.788	136.525	46.038	46.038	36.512	715348/715311	224000	355000	2,700	3,500	2.840
79.375	146.050	41.275	41.275	31.750	661/653	206000	295000	2,600	3,300	2.910
79.375	161.925	47.625	48.260	38.100	756A/752	270000	385000	2,400	3,100	4.550
79.375	190.500	57.150	57.531	46.038	221431/221410	445000	610000	2,000	2,600	8.520
80.000	130.000	35.000	34.000	28.500	515649/515610	166000	249000	2,800	3,600	1.730
80.962	133.350	33.338	33.338	26.195	47681/47620	153000	235000	2,700	3,500	1.780
80.962	136.525	30.162	29.769	22.225	496/493	129000	189000	2,700	3,500	1.690
80.962	139.992	36.512	36.098	28.575	581/572	178000	265000	2,600	3,400	2.260
80.962	150.089	44.450	46.672	36.512	740/742	261000	360000	2,500	3,200	3.430
82.550	125.412	25.400	25.400	19.845	27687/27620	102000	163000	2,800	3,600	1.070
82.550	133.350	33.338	33.338	26.195	47686/47620	153000	235000	2,700	3,500	1.720
82.550	133.350	33.338	33.338	26.195	47686/47620A	153000	235000	2,700	3,500	1.730
82.550	133.350	33.338	33.338	26.195	47687/47620	153000	235000	2,700	3,500	1.710
82.550	133.350	39.688	39.688	32.545	516448/516410	177000	305000	2,700	3,500	2.160

Inch Series

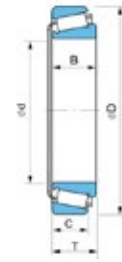

Principal dimensions					Designation	Basic Load Ratings		Speed Ratings		Mass
d	D	T	B	C		Dynamic	Static	Reference speed	Limiting speed	
mm						C	C ₀	reference speed	Limiting speed	
82.550	133.350	39.688	39.688	32.545	516449/516410	177000	305000	2,700	3,500	2.180
82.550	136.525	30.162	29.769	22.225	495/493	129000	189000	2,700	3,500	1.640
82.550	139.992	36.512	36.098	28.575	580/572	178000	265000	2,600	3,400	2.200
82.550	139.992	36.512	36.098	28.575	582/572	178000	265000	2,600	3,400	2.190
82.550	146.050	41.275	41.275	31.750	663/653	206000	295000	2,600	3,300	2.780
82.550	150.089	44.450	46.672	36.512	749A/742	261000	360000	2,500	3,200	3.370
82.550	152.400	39.688	36.322	30.162	595/592A	180000	279000	2,400	3,100	3.020
82.550	152.400	41.275	41.275	31.750	663/652	206000	295000	2,600	3,300	3.150
82.550	161.925	47.625	48.260	38.100	757/752	270000	385000	2,400	3,100	4.420
82.550	161.925	53.975	55.100	42.862	6559C/6535	310000	460000	2,300	3,000	5.090
82.550	168.275	53.975	56.363	41.275	842/832	340000	460000	2,300	3,000	5.460
83.345	125.412	25.400	25.400	19.845	27689/27620	102000	163000	2,800	3,600	1.060
83.345	125.412	25.400	25.400	19.845	27690/27620	102000	163000	2,800	3,600	1.050
83.345	125.412	25.400	25.400	19.845	27691/27620	102000	163000	2,800	3,600	1.040
84.138	136.525	30.162	29.769	22.225	498/493	129000	189000	2,700	3,500	1.600
85.000	130.000	30.000	29.000	24.000	716648/716610	135000	214000	2,700	3,500	1.370
85.000	130.000	30.000	29.000	24.000	716649/716610	135000	214000	2,700	3,500	1.390
85.000	140.000	39.000	38.000	31.500	516849/516810	197000	297000	2,600	3,400	2.300
85.026	150.089	44.450	46.672	36.512	749/742	261000	360000	2,500	3,200	3.250
85.026	150.089	44.450	46.672	36.512	749S/742	261000	360000	2,500	3,200	3.240
85.725	133.350	30.162	29.769	22.225	497/492A	129000	189000	2,700	3,500	1.430



Inch Series

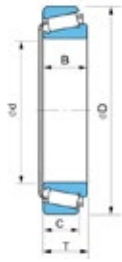

Principal dimensions					Designation	Basic Load Ratings		Speed Ratings		Mass
d	D	T	B	C		Dynamic	Static	Reference speed	Limiting speed	
mm						C	C ₀	speed	speed	
85.725	136.525	30.162	29.769	22.225	497/493	129000	189000	2,700	3,500	1.550
85.725	136.525	30.162	29.769	22.225	497A/493	129000	189000	2,700	3,500	1.530
85.725	142.138	42.862	42.862	34.133	617049/617010	216000	350000	2,600	3,300	2.690
85.725	146.050	41.275	41.275	31.750	665/653	206000	295000	2,600	3,300	2.650
85.725	146.050	41.275	41.275	31.750	665A/653	206000	295000	2,600	3,300	2.630
85.725	152.400	39.688	36.322	30.162	596/592A	180000	279000	2,400	3,100	2.900
85.725	161.925	47.625	48.260	38.100	758/752	270000	385000	2,400	3,100	4.260
87.960	148.430	28.575	28.971	21.433	42346/42584	138000	215000	2,400	3,100	1.990
88.900	121.442	15.083	15.083	11.112	217849/L1217810	56500	88000	2,800	3,600	0.452
88.900	123.825	20.638	20.638	16.670	217849/L217810	80000	141000	2,700	3,500	0.737
88.900	148.430	28.575	28.971	21.433	42350/42584	138000	215000	2,400	3,100	1.960
88.900	152.400	39.688	36.322	30.162	593/592A	180000	279000	2,400	3,100	2.780
88.900	152.400	39.688	36.322	30.162	593A/592A	180000	279000	2,400	3,100	2.760
88.900	161.925	47.625	48.260	38.100	759/752	270000	385000	2,400	3,100	4.090
88.900	161.925	47.625	48.260	38.100	766/752	270000	385000	2,400	3,100	4.070
88.900	161.925	53.975	55.100	42.862	6580/6535	310000	460000	2,300	3,000	4.730
88.900	168.275	53.975	56.363	41.275	850/832	340000	460000	2,300	3,000	5.080
89.974	146.975	40.000	40.000	32.500	218248/218210	227000	340000	2,500	3,200	2.550
90.000	145.000	35.000	34.000	27.000	718149/718110	189000	279000	2,500	3,200	2.140
90.000	155.000	44.000	44.000	35.500	318448/318410	270000	385000	2,400	3,100	3.320
90.000	190.000	50.800	46.038	31.750	90354/90748	281000	365000	1,900	2,400	6.320

Inch Series

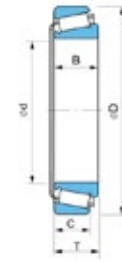

Principal dimensions					Designation	Basic Load Ratings		Speed Ratings		Mass
d	D	T	B	C		Dynamic	Static	Reference speed	Limiting speed	
mm						C	C ₀	speed	speed	
90.488	161.925	47.625	48.260	38.100	760/752	270000	385000	2,400	3,100	4.010
92.075	146.050	33.338	34.925	26.195	47890/47820	163000	266000	2,400	3,100	2.080
92.075	152.400	39.688	36.322	30.162	598/592A	180000	279000	2,400	3,100	2.650
92.075	152.400	39.688	36.322	30.162	598A/592A	180000	279000	2,400	3,100	2.630
92.075	168.275	41.275	41.275	30.162	681/672	222000	340000	2,200	2,800	3.870
92.075	168.275	41.275	41.275	30.162	681A/672	222000	340000	2,200	2,800	3.860
93.662	148.430	28.575	28.971	21.433	42368/42584	138000	215000	2,400	3,100	1.800
95.000	150.000	35.000	34.000	27.000	719149/719113	180000	278000	2,400	3,100	2.190
95.250	130.175	20.638	21.433	16.670	319249/319210	81000	147000	2,600	3,300	0.789
95.250	146.050	33.338	34.925	26.195	47896/47820	163000	266000	2,400	3,100	1.950
95.250	147.638	35.717	36.322	26.192	594A/592XE	180000	279000	2,400	3,100	2.090
95.250	147.638	35.717	36.322	26.192	594A/592XS	180000	279000	2,400	3,100	2.090
95.250	148.430	28.575	28.971	21.433	42375/42584	138000	215000	2,400	3,100	1.750
95.250	152.400	39.688	36.322	30.162	594/592A	180000	279000	2,400	3,100	2.510
95.250	152.400	39.688	36.322	30.162	594A/592A	180000	279000	2,400	3,100	2.510
95.250	157.162	36.512	36.116	26.195	52375/52618	188000	305000	2,300	2,900	2.760
95.250	168.275	41.275	41.275	30.162	683/672	222000	340000	2,200	2,800	3.720
95.250	190.500	57.150	57.531	46.038	221440/221410	445000	610000	2,000	2,600	7.500
96.838	148.430	28.575	28.971	21.433	42381/42584	138000	215000	2,400	3,100	1.690
96.838	188.912	50.800	46.038	31.750	90381/90744	281000	365000	1,900	2,400	5.670
98.425	157.162	36.512	36.116	26.195	52387/52618	188000	305000	2,300	2,900	2.620



Inch Series

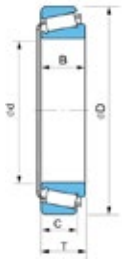

Principal dimensions					Designation	Basic Load Ratings		Speed Ratings		Mass
d	D	T	B	C		Dynamic	Static	Reference	Limiting	
mm						C	C ₀	speed	speed	
						N		r/min		kg
98.425	168.275	41.275	41.275	30.162	685/672	222000	340000	2,200	2,800	3.560
99.974	212.725	66.675	66.675	53.975	224334/224310	575000	810000	1,800	2,300	11.500
100.000	155.000	36.000	35.000	28.000	720249/720210	192000	310000	2,300	2,900	2.400
100.000	160.000	41.000	40.000	32.000	720249/720210	235000	370000	2,300	2,900	3.040
100.012	157.162	36.512	36.116	26.195	52393/52618	188000	305000	2,300	2,900	2.550
101.600	157.162	36.512	36.116	26.195	52400/52618	188000	305000	2,300	2,900	2.480
101.600	161.925	39.688	36.116	29.370	52400/52638	188000	305000	2,300	2,900	2.890
101.600	168.275	41.275	41.275	30.162	687/672	222000	340000	2,200	2,800	3.400
101.600	180.975	47.625	48.006	38.100	780/772	285000	430000	2,100	2,700	5.110
101.600	190.500	57.150	57.531	44.450	861/854	380000	555000	2,000	2,600	7.000
101.600	190.500	57.150	57.531	46.038	221449/221410	445000	610000	2,000	2,600	7.060
101.600	190.500	57.150	57.531	46.038	221449A/221410	445000	610000	2,000	2,600	7.060
101.600	212.725	66.675	66.675	53.975	941/932	475000	695000	1,800	2,300	11.200
101.600	212.725	66.675	66.675	53.975	224335/224310	575000	810000	1,800	2,300	11.300
104.775	180.975	47.625	48.006	38.100	782/772	285000	430000	2,100	2,700	4.920
104.775	180.975	47.625	48.006	38.100	786/772	285000	430000	2,100	2,700	4.900
104.775	180.975	47.625	48.006	38.100	787/772	285000	430000	2,100	2,700	4.900
107.950	158.750	23.020	21.438	15.875	37425/37625	102000	166000	2,200	2,800	1.370
107.950	159.987	34.925	34.925	26.988	522546/522510	167000	320000	2,200	2,800	2.370
107.950	165.100	36.512	36.512	26.988	56425/56650	191000	315000	2,100	2,700	2.690
107.950	168.275	36.512	36.512	26.988	56425/56662	191000	315000	2,100	2,700	2.870

Inch Series

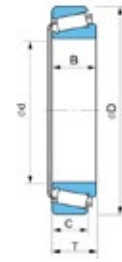

Principal dimensions					Designation	Basic Load Ratings		Speed Ratings		Mass
d	D	T	B	C		Dynamic	Static	Reference	Limiting	
mm						C	C ₀	speed	speed	
						N		r/min		kg
107.950	212.725	66.675	66.675	53.975	936/932	475000	695000	1,800	2,300	10.700
109.538	158.750	23.020	21.438	15.875	37431/37625	102000	166000	2,200	2,800	1.330
109.987	159.987	34.925	34.925	26.988	522548/522510	167000	320000	2,200	2,800	2.240
109.987	159.987	34.925	34.925	26.988	522549/522510	167000	320000	2,200	2,800	2.270
109.992	177.800	41.275	41.275	30.162	64433/64700	232000	375000	2,000	2,600	3.770
110.000	165.000	35.000	35.000	26.500	822049/822010	191000	315000	2,100	2,700	2.520
110.000	180.000	47.000	46.000	38.000	522649/522610	305000	480000	2,000	2,600	4.610
111.125	214.312	55.562	52.388	39.688	924045/924010	405000	560000	1,600	2,000	8.180
114.300	177.800	41.275	41.275	30.162	64450/64700	232000	375000	2,000	2,600	3.520
114.300	179.974	41.275	41.275	30.162	64450/64708	232000	375000	2,000	2,600	3.670
114.300	180.975	34.925	31.750	25.400	68450/68712	169000	245000	1,900	2,500	2.930
114.300	212.725	66.675	66.675	53.975	938/932	475000	695000	1,800	2,300	10.100
114.300	212.725	66.675	66.675	53.975	224346/224310	575000	810000	1,800	2,300	10.200
114.300	228.600	53.975	49.428	38.100	926740/926710	430000	620000	1,500	1,900	9.760
115.087	190.500	47.625	49.212	34.925	71453/71750	300000	475000	1,900	2,500	5.110
115.087	190.500	47.625	49.212	34.925	71455/71750	300000	475000	1,900	2,500	5.080
117.475	180.975	34.925	31.750	25.400	68462/68712	169000	245000	1,900	2,500	2.780
120.000	170.000	25.400	25.400	19.050	724348/724314	127000	210000	2,000	2,600	1.670
120.650	234.950	63.500	63.500	49.212	95475/95925	525000	825000	1,600	2,000	12.600
123.825	182.562	39.688	38.100	33.338	48286/48220	224000	435000	1,900	2,400	3.520
127.000	182.562	39.688	38.100	33.338	48290/48220	224000	435000	1,900	2,400	3.330



Inch Series

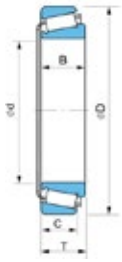

Principal dimensions					Designation	Basic Load Ratings		Speed Ratings		Mass
d	D	T	B	C		Dynamic	Static	Reference	Limiting	
mm						C	C ₀	speed	speed	
						N		r/min		kg
127.000	196.850	46.038	46.038	38.100	67388/67322	310000	550000	1,700	2,200	5.100
127.000	215.900	47.625	47.625	34.925	74500/74850	320000	540000	1,600	2,100	7.050
127.000	228.600	53.975	49.428	38.100	97500/97900	320000	445000	1,500	1,900	8.430
127.000	228.600	53.975	49.428	38.100	926747/926710	430000	620000	1,500	1,900	8.830
127.000	230.000	63.500	63.500	49.212	95500/95905	525000	825000	1,600	2,000	12.900
127.000	234.950	63.500	63.500	49.212	95500/95925	525000	825000	1,600	2,000	12.000
127.000	254.000	77.788	82.550	61.912	228349/228310	740000	1070000	1,500	1,900	19.500
128.588	206.375	47.625	47.625	34.925	799/792	315000	520000	1,700	2,200	5.770
130.175	196.850	46.038	46.038	38.100	67389/67322	310000	550000	1,700	2,200	4.870
130.175	206.375	47.625	47.625	34.925	799A/792	315000	520000	1,700	2,200	5.650
133.350	177.008	25.400	26.195	20.638	327249/327210	126000	259000	1,900	2,400	1.700
133.350	190.500	39.688	39.688	33.338	48385/48320	236000	475000	1,800	2,300	3.640
133.350	196.850	46.038	46.038	38.100	67390/67322	310000	550000	1,700	2,200	4.630
133.350	196.850	46.038	46.038	38.100	67391/67322	310000	550000	1,700	2,200	4.590
133.350	215.900	47.625	47.625	34.925	74525/74850	320000	540000	1,600	2,100	6.560
133.350	234.950	63.500	63.500	49.212	95525/95925	525000	825000	1,600	2,000	11.300
133.350	234.950	63.500	63.500	49.212	95528/95925	525000	825000	1,600	2,000	11.400
136.525	190.500	39.688	39.688	33.338	48393/48320	236000	475000	1,800	2,300	3.430
136.525	228.600	57.150	57.150	44.450	896/892	445000	735000	1,600	2,000	9.070
139.700	214.975	47.625	47.625	34.925	74550/74845	320000	540000	1,600	2,100	5.970
139.700	215.900	47.625	47.625	34.925	74550/74850	320000	540000	1,600	2,100	6.050

Inch Series

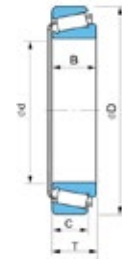

Principal dimensions					Designation	Basic Load Ratings		Speed Ratings		Mass
d	D	T	B	C		Dynamic	Static	Reference	Limiting	
mm						C	C ₀	speed	speed	
						N		r/min		kg
139.700	228.600	57.150	57.150	44.450	898/892	445000	735000	1,600	2,000	8.760
139.700	228.600	57.150	57.150	44.450	898A/892	445000	735000	1,600	2,000	8.730
139.700	254.000	66.675	66.675	47.625	99550/99100	550000	910000	1,400	1,800	14.300
142.875	200.025	41.275	39.688	34.130	48684/48620	239000	490000	1,600	2,100	3.850
142.875	200.025	41.275	39.688	34.130	48685/48620	239000	490000	1,600	2,100	3.890
146.050	193.675	28.575	28.575	23.020	36690/36620	165000	340000	1,700	2,200	2.270
146.050	193.675	28.575	28.575	23.020	36691/36620	165000	340000	1,700	2,200	2.250
146.050	254.000	66.675	66.675	47.625	99575/99100	550000	910000	1,400	1,800	13.500
152.400	192.088	25.000	24.000	19.000	630349/630310	130000	261000	1,600	2,100	1.530
152.400	222.250	46.830	46.830	34.925	231648/231610	315000	585000	1,600	2,000	5.720
152.400	222.250	46.830	46.830	34.925	231649/231610	315000	585000	1,600	2,000	5.770
158.750	205.583	23.812	23.812	18.258	432349/432310	126000	247000	1,600	2,000	1.890
158.750	225.425	41.275	39.688	33.338	46780/46720	254000	555000	1,500	1,900	5.200
165.100	225.425	41.275	39.688	33.338	46790/46720	254000	555000	1,500	1,900	4.690
170.000	230.000	39.000	38.000	31.000	534149/534110	282000	520000	1,400	1,800	4.370
177.800	227.012	30.162	30.162	23.020	36990/36920	181000	415000	1,400	1,800	2.920
177.800	247.650	47.625	47.625	38.100	67790/67720	340000	690000	1,300	1,700	6.570
180.000	250.000	47.000	45.000	37.000	736149/736110	370000	710000	1,300	1,700	6.760
190.000	260.000	46.000	44.000	36.500	738249/738210	365000	720000	1,300	1,600	6.850
196.850	241.300	23.812	23.017	17.462	639249/639210	160000	330000	1,200	1,600	2.070



Double Row Metric Series

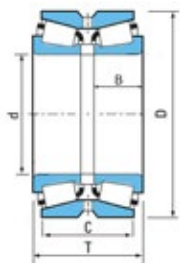

Principal dimensions					Designation	Basic Load Ratings		Speed Ratings		Mass
d	D	B	C	T		Dynamic C	Static C ₀	Reference speed	Limiting speed	
mm						N		r/min		
160	240	48	94	115	35032	662000	1288000	950	1,400	17
180	280	60	108	134	35036	1154000	2352000	850	1,200	29.9
200	310	66	123	152	35040	1268000	2526000	800	1,100	39.3
220	340	72	130	165	35044	1469000	3032000	750	1,000	50.1

*Note: Other types of Double row tapered roller bearings can be developed as per customer request

Double Row Inch Series



Principal dimensions					Designation	Basic Load Ratings		Speed Ratings		Mass
d	D	B	C	T		Dynam- ic C	Static C ₀	Refer- ence speed	Limiting speed	
mm						N		r/min		
69.85	114.287	25.4	46.038	58.738	29675/29622 DC	180000	295000	2,400	3,000	2.05
69.85	120	29.007	53.975	65.09	482/472 D	255000	415000	2,200	2,800	2.45
73.025	114.287	25.4	46.038	58.738	29685/29622 D	180000	295000	2,400	2,800	1.91
82.55	136.525	29.769	53.975	69.85	495/493 D	255000	450000	2,000	2,400	3.84
85.725	136.525	29.769	53.975	69.85	497/493 DC	255000	450000	1,900	2,400	3.72
92.075	149.225	28.971	52.387	66.672	42362/42587	275000	510000	1,800	2,200	4.37
107.95	158.75	21.4	39.688	53.978	37425/37626 D	170000	335000	1,600	2,000	3.26
107.95	159.987	34.925	58.738	74.89	LM4522546/LM522510 DC	280000	630000	1,600	2,000	4.97
114.3	190.5	49.2	80.962	106.362	71450/7175 D	530000	980000	1,400	1,800	10.8
115	190.5	50	82.6	108	181115/181190 XG	435000	750000	1,400	1,800	10.1
127	196.85	46	85.725	101.6	67388/67322 D	540000	1130000	1,300	1,700	10.6
136.525	190.5	39.7	73.025	85.725	48393/48320 D	395000	940000	1,300	1,700	6.88
136.525	215.9	51	92	110	200136X/200215	540000	960000	1,200	1,500	12.2
152.4	222.25	46.8	76.2	100.01	M231649/M23160 D	540000	1190000	1,200	1,400	11.7
203.2	282.575	46.038	82.55	101.6	67983/67920 DC	600000	1410000	900	1,100	17.8



Spherical Roller and Plain Bearings



Spherical Roller Bearings

Spherical Roller Bearings have two Raceways on Inner Ring, and one Spherical Raceway on the Outer Ring. As the name implies, the Rolling Elements of the Bearing have a spherical profile.



Spherical Roller Bearings

Spherical roller bearings have two rows of rollers, a common sphered outer ring raceway and two inner ring raceways inclined at an angle to the bearing axis. The centre point of the sphere in the outer ring raceway is at the bearing axis. Therefore, the bearings are self-aligning and insensitive to misalignment of the shaft relative to the housing, which can be caused, for example, by shaft deflection. Spherical roller bearings are designed to accommodate heavy radial loads, as well as heavy axial loads in both directions.

Spherical Roller Bearings are

- Capable of carrying both radial loads and axial loads
- Suitable for low and medium speed applications
- Suitable for applications where some mis-alignment of Shaft can arise KG can offer following variants
- Single Row type - 202 series (details available on request)
- Double Row type - 213, 222, 223, 230, 231, 232, 239, 240, 241
- Plain type - GE
- With C2, CN, C3 and C4 radial clearance
- Pressed Steel or machined Brass Cage



Spherical Roller Bearings

Apart from the list of items presented in the following pages, many other type of Spherical Roller Bearings can also be developed to meet specific application requirements. Technical information for Bearings not appearing in our production program, is available on request.

MB design

These bearing have fixed rib and machined cages guided on the inner ring rib. **KG can offer this design bearings upon request.**



C design

This bearing have central guide floating on the inner ring, symmetrical rollers with larger dimensions so that the load carrying capacity increases. Special pressed sheet cage. Bearings of this design are of small and medium sizes



CA

These bearings have side shoulders and an one-piece machined brass cage. They also have symmetrical rollers with larger dimensions so that the load carrying capacity increases. This design is available for medium and large-sized bearings **Bearing with Cylindrical bore, lubrication groove and holes in the outer ring**

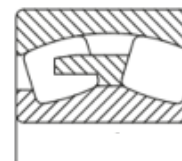

With withdrawal sleeves

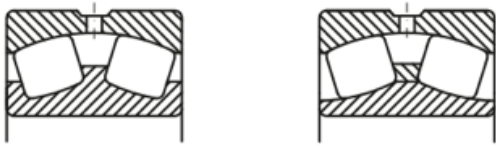

Tapered bore, lubrication groove and holes in the outer ring (taper 1:12, 1:30)

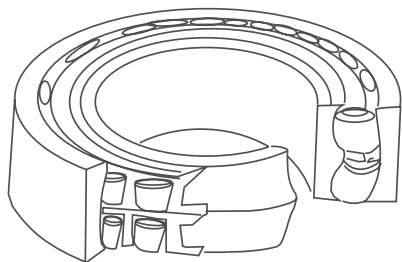
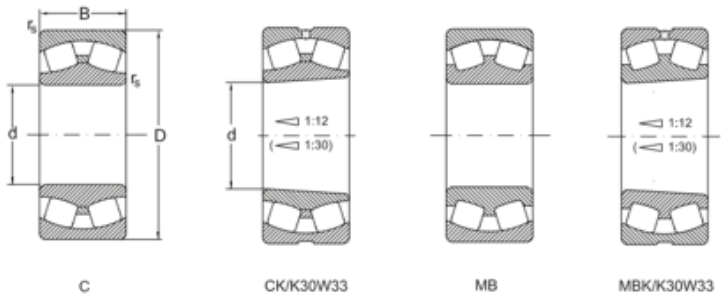
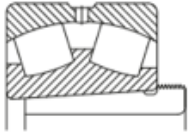

KG standard suffixes for Spherical Roller Bearings

A	Modified internal design.
C2	Radial internal clearance less than normal.
CN	Normal radial internal clearance. Generally, no special suffix is used in KG Bearings for normal radial internal clearance.
C3	Radial internal clearance higher than normal.
C4	Radial internal clearance higher than C3.
C	Pressed Steel Cage.
CA	Machined Brass Cage, one-piece Cage.
K	Tapered Bore, with taper of 1:12.
K30	Tapered Bore, with taper of 1:30.
MB	Machined Brass Cage, split type.
Q1-Q3	KG internal reference codes. For details please contact KG International FZCO.
W33	Oil groove with oil holes in the Outer Ring.

Spherical Plain Bearings

Spherical Plain Bearings (also known as “Spherical Plain Bearings” “Spherical Ball Bushing Bearings” and “Ball Bushings”) have an inner ring with a sphere convex outside surface and an outer ring with a correspondingly sphere, but concave inside surface. Their design makes them particularly suitable for bearing arrangements where alignment movements between shaft and housing have to accommodate, or where oscillating or recurrent tilting movements must be permitted at relatively slow sliding speeds.



Note: Most of the Bearings listed in the following pages of this chapter are available with above suffixes, subject to design or manufacturing constraints.



Series: **213**



C Type

Principal dimensions			Designation	Basic Load Ratings		Speed ratings		Mass
d	D	B		Dynamic	Static	Reference speed	Limiting speed	
mm				C	C ₀	r/min		
				N				
20	52	15	21304CW33	40500	33500	15,000	10,100	0.16
25	62	17	21305CW3	48000	41500	9,300	12,000	0.28
30	72	19	21306CW33	64000	61000	8,200	10,000	0.41
35	80	21	21307CW33	76500	72000	7,300	9,500	0.55
40	90	23	21308CW33	104000	108000	7,000	9,500	0.75
45	100	25	21309CW33	125000	127000	6,300	8,500	0.99
50	110	27	21310CW33	156000	166000	5,600	7,500	1.35
55	120	29	21311CW33	156000	166000	5,600	7,500	1.70
60	130	31	21312CW33	212000	240000	4,800	6,300	2.10
65	140	33	21313CW33	236000	270000	4,300	6,000	2.55
70	150	35	21314CW33	285000	325000	4,000	5,600	3.10
75	160	37	21315CW33	285000	325000	4,000	5,600	3.75
80	170	39	21316CW33	325000	375000	3,800	5,300	4.45
85	180	41	21317CW33	325000	375000	3,800	5,300	5.20
90	190	43	21318CW33	380000	450000	3,600	4,800	6.10
95	200	45	21319CW33	425000	490000	3,400	4,500	7.05
100	215	47	21320CW33	425000	490000	3,400	4,500	8.60

Series: **222**

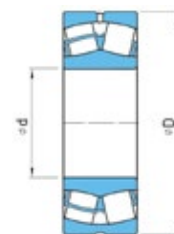

C Type

Principal dimensions			Designation	Basic Load Ratings		Speed ratings		Mass
d	D	B		Dynamic	Static	Reference speed	Limiting speed	
mm				C	C ₀	r/min		
				N				
25	52	18	22205CW33	49000	44000	13,000	17,000	0.26
30	62	20	22206CW33	64000	60000	10,000	14,000	0.29
35	72	23	22207CW33	86500	85000	9,000	12,000	0.45
40	80	23	22208CW33	96500	90000	8,000	11,000	0.53
45	85	23	22209CW33	102000	98000	7,500	10,000	0.58
50	90	23	22210CW33	104000	108000	7,000	9,500	0.63
55	100	25	22211CW33	125000	127000	6,300	8,500	0.84
60	110	28	22212CW33	156000	166000	5,600	7,500	1.15
65	120	31	22213CW33	193000	216000	5,000	7,000	1.55
70	125	31	22214CW33	208000	228000	5,000	6,700	1.55
75	130	31	22215CW33	212000	240000	4,800	6,300	1.70
80	140	33	22216CW33	236000	270000	4,300	6,000	2.10
85	150	36	22217CW33	285000	325000	4,000	5,600	2.70
90	160	40	22218CW33	325000	375000	3,800	5,300	3.40
95	170	43	22219CW33	380000	450000	3,600	4,800	4.15
100	180	46	22220CW33	425000	490000	3,400	4,500	4.90
110	200	53	22222CW33	560000	640000	3,000	4,000	7.00
120	215	58	22224CW33	630000	765000	2,800	3,800	8.70
130	230	64	22226CW33	735000	930000	2,600	3,600	11.00
140	250	68	22228CW33	710000	900000	2,400	3,200	14.00
150	270	73	22230CW33	850000	1080000	2,200	3,000	18.00
160	290	80	22232CW33	1000000	1290000	2,000	2,800	22.50
170	310	86	22234CW33	1120000	1460000	1,900	2,600	28.50
180	320	86	22236CW33	1180000	1560000	1,800	2,600	29.50
190	340	92	22238CW33	1270000	1700000	1,700	2,400	36.50
200	360	98	22240CW33	1460000	1930000	1,600	2,200	43.50
220	400	108	22244CW33	1760000	2360000	1,500	2,000	60.50
240	440	120	22248CW33	2200000	3000000	1,300	1,800	83.00
260	480	130	22252CW33	2650000	3550000	1,200	1,600	110.00
280	500	130	22256CW33	2700000	3750000	1,100	1,500	115.00
300	540	140	22260CW33	3150000	4250000	1,000	1,400	135.00



Series: **223**



C Type

Principal dimensions			Designation	Basic Load Ratings		Speed ratings		Mass
d	D	B		Dynamic	Static	Reference speed	Limiting speed	
mm				C	C ₀	r/min		
				N				
40	90	33	22308CW33	150000	140000	6,000	8,000	1.05
45	100	36	22309CW33	183000	183000	5,300	7,000	1.40
50	110	40	22310CW33	220000	224000	4,800	6,300	1.90
55	120	43	22311CW33	270000	280000	4,300	5,600	2.45
60	130	46	22312CW33	310000	335000	4,000	5,300	3.10
65	140	48	22313CW33	340000	360000	3,800	5,000	3.75
70	150	51	22314CW33	400000	430000	3,400	4,500	4.55
75	160	55	22315CW33	440000	475000	3,200	4,300	5.55
80	170	58	22316CW33	490000	540000	3,000	4,000	6.60
85	180	60	22317CW33	550000	620000	2,800	3,800	7.65
90	190	64	22318CW33	610000	695000	2,600	3,600	9.05
95	200	67	22319CW33	670000	765000	2,600	3,400	10.50
100	215	73	22320CW33	815000	950000	2,400	3,000	13.50
110	240	80	22322CW33	950000	1120000	2,000	2,800	18.50
120	260	86	22324CW33	965000	1120000	2,000	2,600	23.00
130	280	93	22326CW33	1120000	1320000	1,800	2,400	29.00
140	300	102	22328CW33	1290000	1560000	1,700	2,200	36.50
150	320	108	22330CW33	1460000	1760000	1,600	2,000	43.50
160	340	114	22332CW33	1600000	1960000	1,500	1,900	52.00
170	360	120	22334CW33	1760000	2160000	1,400	1,800	61.00
180	380	126	22336CW33	2000000	2450000	1,300	1,700	71.50
190	400	132	22338CW33	2120000	2650000	1,200	1,600	82.50
200	420	138	22340CW33	2320000	2900000	1,200	1,500	95.00
220	460	145	22344CW33	2700000	3450000	1,000	1,400	120.00
240	500	155	22348CW33	3100000	4000000	950	1,300	155.00
260	540	165	22352CW33	3550000	4550000	850	1,100	190.00
280	580	175	22356CW33	4000000	5200000	800	1,100	235.00

Series: **230**

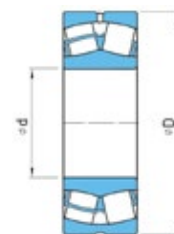

C Type

Principal dimensions			Designation	Basic Load Ratings		Speed ratings		Mass
d	D	B		Dynamic	Static	Reference speed	Limiting speed	
mm				C	C ₀	r/min		
				N				
110	170	45	23022CW33	310000	440000	3,400	4,300	3.80
120	180	46	23024CW33	355000	510000	3,200	4,000	4.20
130	200	52	23026CW33	430000	610000	2,800	3,600	6.00
140	210	53	23028CW33	465000	680000	2,600	3,400	6.55
150	225	56	23030CW33	510000	750000	2,400	3,200	7.95
160	240	60	23032CW33	585000	880000	2,400	3,000	9.70
170	260	67	23034CW33	710000	1060000	2,200	2,800	13.00
180	280	74	23036CW33	830000	1250 000	2,000	2,600	17.00
190	290	75	23038CW33	865000	1340000	1,900	2,400	18.00
200	310	82	23040CW33	1000000	1530000	1,800	2,200	23.50
220	340	90	23044CW33	1220000	1860000	1,600	2,000	30.50
240	360	92	23048CW33	1290000	2080000	1,500	1,900	33.50
260	400	104	23052CW33	1600000	2550000	1,300	1,700	48.50
280	420	106	23056CW33	1730000	2850000	1,300	1,600	52.50
300	460	118	23060CW33	2120000	3450000	1,200	1,500	71.50
320	480	121	23064CW33	2240000	3800000	1,100	1,400	78.00
340	520	133	23068CW33	2700000	4550000	1,000	1,300	105.00
360	540	134	23072CW33	2750000	4800000	950	1,200	110.00



Series: **230**



C Type

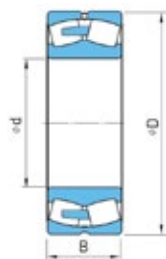

CA Type

Principal dimensions			Designation	Basic Load Ratings		Speed ratings		Mass
d	D	B		Dynamic	Static	Reference speed	Limiting speed	
mm				C	C ₀	r/min		
				N				
380	560	135	23076CW33	2900000	5000000	900	1,200	115.00
400	600	148	23080CW33	3400000	5850000	850	1,100	150.00
420	620	150	23084CW33	3400000	6000000	600	1,100	155.00
440	650	157	23088CW33	3650000	6550000	560	1,000	180.00
460	680	163	23092CW33	3900000	6950000	560	950	205.00
480	700	165	23096CW33	3900000	6800000	530	950	215.00
500	720	167	230/500CAW33	4150000	7800000	500	900	225.00
530	780	185	230/530CAW33	5100000	9300000	450	800	310.00
560	820	195	230/560CAW33	5600000	10200000	430	750	355.00
600	870	200	230/600CAW33	6000000	11400000	400	700	405.00
630	920	212	230/630CAW33	6700000	12500000	380	670	485.00
670	980	230	230/670CAW33	7650000	14600000	340	600	600.00
710	1030	236	230/710CAW33	8300000	16300000	300	560	670.00
750	1090	250	230/750CAW33	9650000	18600000	280	530	795.00
800	1150	258	230/800CAW33	10000000	20000000	260	480	895.00
850	1220	272	230/850CAW33	10800000	21600000	240	450	1,050.00
900	1280	280	230/900CAW33	11600000	23200000	220	400	1,200.00

Series: **231**

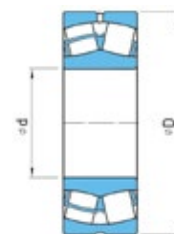

C Type

Principal dimensions			Designation	Basic Load Ratings		Speed ratings		Mass
d	D	B		Dynamic	Static	Reference speed	Limiting speed	
mm				C	C ₀	r/min		
				N				
100	165	52	23120CW33	365000	490000	3,000	4,000	4.55
110	180	56	23122CW33	430000	585000	2,800	3,600	5.75
120	200	62	23124CW33	510000	695000	2,600	3,400	8.00
130	210	64	23126CW33	560000	780000	2,400	3,200	8.80
140	225	68	23128CW33	630000	900000	2,200	2,800	10.50
150	250	80	23130CW33	830000	1200000	2,000	2,600	16.00
160	270	86	23132CW33	980000	1370000	1,900	2,400	20.50
170	280	88	23134CW33	1040000	1500000	1,800	2,400	22.00
180	300	96	23136CW33	1200000	1760000	1,700	2,200	28.00
190	320	104	23138CW33	1370000	2080000	1,500	2,000	35.00
200	340	112	23140CW33	1600000	2360000	1,500	1,900	43.00
220	370	120	23144CW33	1800000	2750000	1,300	1,700	53.50
240	400	128	23148CW33	2080000	3200000	1,200	1,600	66.50
260	440	144	23152CW33	2550000	3900000	1,100	1,400	90.50
280	460	146	23156CW33	2650000	4250000	1,000	1,300	97.00
300	500	160	23160CW33	3200000	5100000	950	1,200	125.00
320	540	176	23164CW33	3750000	6000000	850	1,100	165.00
340	580	190	23168CW33	4250000	6800000	800	1,000	210.00



Series: **231**



C Type

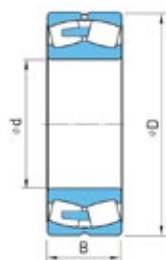

CA Type

Principal dimensions			Designation	Basic Load Ratings		Speed ratings		Mass
d	D	B		Dynamic	Static	Reference speed	Limiting speed	
mm				C	C ₀	r/min		
				N				
360	600	192	23172CAW33	4300000	6950000	750	1,000	220.00
380	620	194	23176CAW33	4400000	7100000	560	1,000	230.00
400	650	200	23180CAW33	4650000	7650000	530	950	265.00
420	700	224	23184CAW33	5600000	9300000	480	900	350.00
440	720	226	23188CAW33	6000000	10000000	450	850	360.00
460	760	240	23192CAW33	6400000	10800000	430	800	440.00
480	790	248	23196CAW33	6950000	12000000	400	750	485.00
500	830	264	231/500CAW33	7650000	12900000	380	700	580.00
530	870	272	231/530CAW33	8150000	14000000	360	670	645.00
560	920	280	231/560CAW33	9150000	16000000	340	630	740.00
600	980	300	231/600CAW33	10200000	18000000	320	560	895.00
630	1030	315	231/630CAW33	12000000	20800000	260	530	1,050.00
670	1090	336	231/670CAW33	12500000	22400000	240	500	1,250.00
710	1150	345	231/710CAW33	14000000	26000000	240	450	1,450.00
750	1220	365	231/750CAW33	15600000	29000000	220	430	1,700.00
800	1280	375	231/800CAW33	17300000	31500000	200	400	1,920.00
850	1360	400	231/850CAW33	18300000	34500000	180	360	2,200.00

Series: **232**



C Type

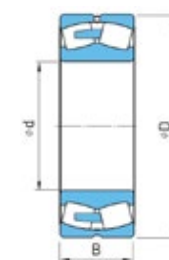

CA Type

Principal dimensions			Designation	Basic Load Ratings		Speed ratings		Mass
d	D	B		Dynamic	Static	Reference speed	Limiting speed	
mm				C	C ₀	r/min		
				N				
90	160	52,4	23218CW33	355000	440000	2,800	3,800	4.65
100	180	60,3	23220CW33	475000	600000	2,400	3,400	6.85
110	200	69,8	23222CW33	600000	765000	2,200	3,200	9.85
120	215	76	23224CW33	695000	930000	2,000	2,800	12.00
130	230	80	23226CW33	780000	1060000	1,900	2,600	14.50
140	250	88	23228CW33	915000	1250000	1,700	2,400	19.00
150	270	96	23230CW33	1080000	1460000	1,600	2,200	24.50
160	290	104	23232CW33	1220000	1660000	1,500	2,200	31.00
170	310	110	23234CW33	1400000	1930000	1,400	2,000	37.50
180	320	112	23236CW33	1500000	2120000	1,300	1,900	39.50
190	340	120	23238CW33	1660000	2400000	1,300	1,800	48.00
200	360	128	23240CW33	1860000	2700000	1,200	1,700	58.00
220	400	144	23244CW33	2360000	3450000	1,100	1,500	81.50
240	440	160	23248CW33	2900000	4300000	950	1,300	110.00
260	480	174	23252CW33	3250000	4750000	850	1,200	140.00
280	500	176	23256CW33	3250000	4900000	800	1,100	150.00
300	540	192	23260CW33	3900000	5850000	750	1,000	190.00
320	580	208	23264CW33	4400000	6700000	700	950	240.00
340	620	224	23268CAW33	5100000	7800000	560	800	295.00
360	650	232	23272CAW33	5400000	8300000	530	750	335.00
380	680	240	23276CAW33	5850000	9150000	500	750	375.00
400	720	256	23280CAW33	6550000	10400000	480	670	450.00
420	760	272	23284CAW33	7350000	11600000	450	630	535.00
440	790	280	23288CAW33	7800000	12500000	430	600	590.00
460	830	296	23292CAW33	8500000	13700000	400	560	695.00
480	870	310	23296CAW33	9300000	15000000	380	530	800.00
500	920	336	232/500CAW33	10600000	17300000	360	500	985.00

Series: **239**

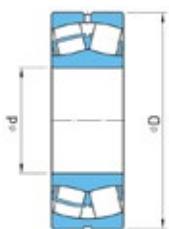

C Type

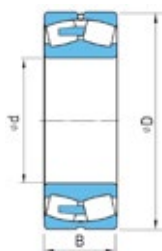

CA Type

Principal dimensions			Designation	Basic Load Ratings		Speed ratings		Mass
d	D	B		Dynamic	Static	Reference speed	Limiting speed	
mm				C	C ₀	r/min		
				N				
180	250	52	23936CW33	490000	830000	2,600	2,800	7.90
190	260	52	23938CW33	475000	800000	2,400	2,600	8.30
200	280	60	23940CW33	620000	1040000	2,200	2,400	11.50
220	300	60	23944CW33	630000	1080000	2,000	2,200	12.50
240	320	60	23948CW33	655000	1160000	1,900	2,000	13.50
260	360	75	23952CW33	1000000	1800000	1,700	1,900	23.50
280	380	75	23956CW33	965000	1760000	1,600	1,700	25.00
300	420	90	23960CW33	1370000	2500000	1,400	1,600	39.50
320	440	90	23964CW33	1430000	2700000	1,400	1,500	42.00
340	460	90	23968CW33	1460000	2800000	1,300	1,400	45.50
360	480	90	23972CW33	1400000	2750000	1,200	1,300	46.00
380	520	106	23976CW33	1960000	3800000	1,100	1,200	69.00
400	540	106	23980CW33	2000000	3900000	1,100	1,200	71.00
420	560	106	23984CW33	2040000	4150000	1,000	1,100	74.50
440	600	118	23988CW33	2450000	4900000	950	1,000	99.50
460	620	118	23992CAW33	2500000	5000000	600	1,000	105.00
480	650	128	23996CAW33	2900000	5700000	560	1,000	125.00
500	670	128	239/500CAW33	2900000	6000000	530	950	130.00
530	710	136	239/530CAW33	3200000	6700000	500	900	155.00
560	750	140	239/560CAW33	3450000	7200000	450	850	175.00
600	800	150	239/600CAW33	3900000	8300000	430	750	220.00
630	850	165	239/630CAW33	4650000	9800000	400	700	280.00
670	900	170	239/670CAW33	5000000	10800000	360	670	315.00
710	950	180	239/710CAW33	5600000	12000000	340	600	365.00
750	1000	185	239/750CAW33	6000000	13200000	320	560	420.00
800	1060	195	239/800CAW33	6400000	14300000	280	530	470.00
850	1120	200	239/850CAW33	6950000	15600000	260	480	560.00
900	1180	206	239/900CAW33	7500000	17000000	240	450	605.00

Series: **240**

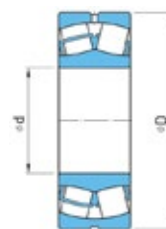

C Type

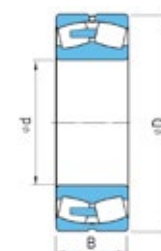

CA Type

Principal dimensions			Designation	Basic Load Ratings		Speed ratings		Mass
d	D	B		Dynamic	Static	Reference speed	Limiting speed	
mm				C	C ₀	r/min		
				N				
120	180	60	24024CW33	430000	670000	2,400	3,400	5.45
130	200	69	24026CW33	540000	815000	2,000	3,000	8.05
140	210	69	24028CW33	570000	900000	2,000	2,800	8.55
150	225	75	24030CW33	655000	1040000	1,800	2,600	10.50
160	240	80	24032CW33	750000	1200000	1,700	2,400	13.00
170	260	90	24034CW33	930000	1460000	1,600	2,400	17.50
180	280	100	24036CW33	1080000	1730000	1,500	2,200	23.00
190	290	100	24038CW33	1120000	1800000	1,400	2,000	24.50
200	310	109	24040CW33	1290000	2120000	1,300	1,900	31.00
220	340	118	24044CW33	1560000	2600000	1,200	1,700	40.00
240	360	118	24048CW33	1600000	2700000	1,100	1,600	43.00
260	400	140	24052CW33	2040000	3450000	1,000	1,400	65.50
280	420	140	24056CW33	2160000	3800000	950	1,400	69.50
300	460	160	24060CW33	2700000	4750000	850	1,200	97.00
320	480	160	24064CW33	2850000	5100000	800	1,200	100.00
340	520	180	24068CW33	3450000	6200000	750	1,100	140.00
360	540	180	24072CW33	3550000	6550000	700	1,000	145.00
380	560	180	24076CW33	3600000	6800000	670	950	150.00
400	600	200	24080CW33	4300000	8000000	630	900	205.00
420	620	200	24084CAW33	4400000	8300000	530	900	210.00
440	650	212	24088CAW33	4800000	9150000	500	850	245.00
460	680	218	24092CAW33	5200000	10000000	480	800	275.00
480	700	218	24096CAW33	5300000	10400000	450	750	285.00
500	720	218	240/500CAW33	5500000	11000000	430	700	295.00
530	780	250	240/530CAW33	6700000	13200000	400	670	410.00
560	820	258	240/560CAW33	7350000	14600000	380	630	465.00
600	870	272	240/600CAW33	8150000	17000000	340	560	520.00



Series: **241**



C Type

Principal dimensions			Designation	Basic Load Ratings		Speed ratings		Mass
d	D	B		Dynamic	Static	Reference speed	Limiting speed	
mm				C	C ₀	r/min		
				N				
100	165	65	24120CW33	455000	640000	2,400	3,200	5.65
110	180	69	24122CW33	520000	750000	2,000	3,000	7.10
120	200	80	24124CW33	655000	950000	1,900	2,600	10.50
130	210	80	24126CW33	680000	1000000	1,700	2,400	11.00
140	225	85	24128CW33	765000	1160000	1,600	2,200	13.50
150	250	100	24130CW33	1200000	1530000	1,400	2,000	20.00
160	270	109	24132CW33	1180000	1760000	1,300	1,900	25.00
170	280	109	24134CW33	1220000	1860000	1,200	1,800	27.50
180	300	118	24136CW33	1400000	2160000	1,100	1,600	34.50
190	320	128	24138CW33	1600000	2500000	1,100	1,500	43.00
200	340	140	24140CW33	1800000	2800000	1,000	1,400	53.50
220	370	150	24144CW33	2120000	3350000	850	1,200	67.00
240	400	160	24148CW33	2400000	3900000	750	1,100	83.00

Series: **241**

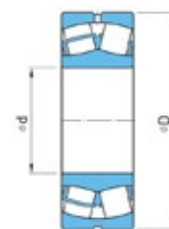

C Type

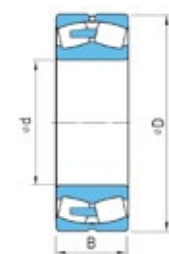

CA Type

Principal dimensions			Designation	Basic Load Ratings		Speed ratings		Mass
d	D	B		Dynamic	Static	Reference speed	Limiting speed	
mm				C	C ₀	r/min		
				N				
260	440	180	24152CW33	3000000	4800000	670	950	110.00
280	460	180	24156CW33	3100000	5100000	630	900	120.00
300	500	200	24160CW33	3750000	6300000	560	800	160.00
320	540	218	24164CW33	4250000	7100000	500	700	210.00
340	580	243	24168CW33	5300000	8650000	430	630	280.00
360	600	243	24172CW33	5600000	9300000	400	600	280.00
380	620	243	24176CAW33	5700000	9800000	360	530	300.00
400	650	250	24180CAW33	6200000	10600000	340	500	340.00
420	700	280	24184CAW33	7350000	12600000	320	480	445.00
440	720	280	24188CAW33	7500000	13200000	300	450	460.00
460	760	300	24192CAW33	8300000	14600000	280	430	560.00
480	790	308	24196CAW33	9000000	15600000	260	400	605.00
500	830	325	241/500CAW33	9800000	17000000	260	380	700.00



Plain Type Series: **GE...E** and **GE...ES**

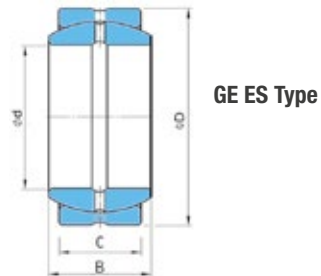
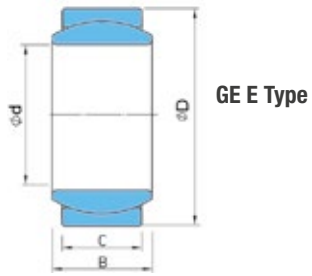

Principal dimensions					Designation	Basic Load Ratings		$\alpha \approx$	Mass
d	D	B	C	d1min		Dynamic	Static		
mm						C	C ₀		
						N			
4	12	5	3	6	GE4E	2000	10000	16	0.0033
5	14	6	4	7	GE5E	3400	17000	13	0.0040
6	14	6	4	8	GE6E	3400	17000	13	0.0042
8	16	8	5	10	GE8E	5500	27000	15	0.0075
10	19	9	6	13	GE10E	8100	40000	12	0.011
12	22	10	7	15	GE12E	10000	54000	10	0.015
15	26	12	9	18	GE15ES	17000	85000	8	0.027
17	30	14	10	20	GE17ES	21000	106000	10	0.041
20	35	16	12	24	GE20ES	30000	146000	9	0.066
25	42	20	16	29	GE25ES	48000	240000	7	0.119
30	47	22	18	34	GE30ES	62000	310000	6	0.153
35	55	25	20	39	GE35ES	80000	400000	6	0.233
40	62	28	22	45	GE40ES	100000	500000	7	0.306

Plain Type Series: **GE...ES**

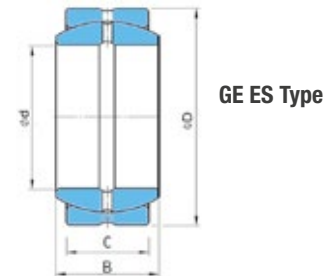

Principal dimensions					Designation	Basic Load Ratings		$\alpha \approx$	Mass
d	D	B	C	d1min		Dynamic	Static		
mm						C	C ₀		
						N			
45	68	32	25	50	GE45ES	127000	640000	7	0.427
50	75	35	28	55	GE50ES	156000	780000	6	0.546
60	90	44	36	66	GE60ES	245000	1220000	6	1.045
70	105	49	40	77	GE70ES	315000	1560000	6	1.55
80	120	55	45	88	GE80ES	400000	2000000	6	2.31
90	130	60	50	98	GE90ES	490000	2450000	5	2.75
100	150	70	55	109	GE100ES	610000	3050000	7	4.45
110	160	70	55	120	GE110ES	655000	3250000	6	4.82
120	180	85	70	130	GE120ES	950000	4750000	6	8.05
140	210	90	70	150	GE140ES	1080000	5400000	7	11.02
160	230	105	80	170	GE160ES	1370000	6800000	8	14.01
180	260	105	80	192	GE180ES	1530000	7650000	6	18.65
200	290	130	100	212	GE200ES	2120000	10600000	7	28.03

Plain Type Series: **GE...E**

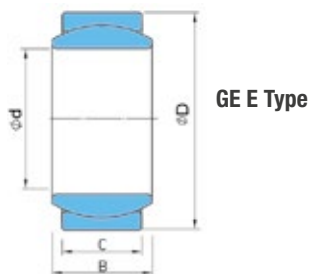

Principal dimensions					Designation	Basic Load Ratings		$\alpha^\circ \approx$	Mass
d	D	B	C	d1min		Dynamic	Static		
mm						C	C ₀		
						N			
20	35	16	12		GE20E	30000	146000	9	0.065
25	42	20	16		GE25E	48000	240000	7	0.115
30	47	22	18		GE30E	62000	310000	6	0.16
35	55	25	20		GE35E	80000	400000	6	0.258
40	62	28	22		GE40E	100000	500000	7	0.315
45	68	32	25		GE45E	127000	640000	7	0.413
50	75	35	28		GE50E	156000	780000	6	0.56
60	90	44	36		GE60E	245000	1220000	6	1.1
70	105	49	40		GE70E	315000	1560000	6	1.54
80	120	55	45		GE80E	400000	2000000	6	2.16
90	130	60	50		GE90E	490000	2450000	5	3.02

Plain Type Series: **GE...E** and **GE...ES**

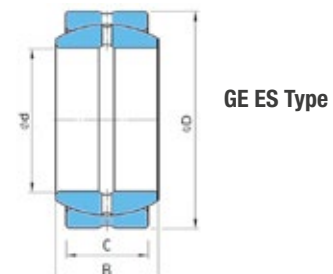
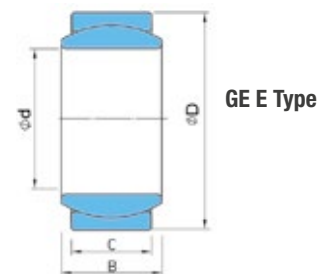

Principal dimensions					Designation	Basic Load Ratings		$\alpha^\circ \approx$	Mass	
d	D	B	C	d1min		Dynamic	Static			
mm						C	C ₀			
						N				kg
4	14	7	4	7	GEG4E	3400	17000	20	0.0045	
5	16	9	5	8	GEG5E	5500	27000	21	0.0066	
6	16	9	5	9	GEG6E	5500	27000	21	0.0081	
8	19	11	6	11	GEG8E	8100	40000	21	0.0140	
10	22	12	7	13	GEG10E	10000	54000	18	0.0210	
12	26	15	9	16	GEG12E	17000	85000	18	0.0330	
15	30	16	10	19	GEG15ES	GEG15ES-2RS	21000	106000	16	0.0490
17	35	20	12	21	GEG17ES	GEG17ES-2RS	30000	146000	19	0.0830
20	42	25	16	24	GEG20ES	GEG20ES-2RS	48000	240000	17	0.1530
25	47	28	18	29	GEG25ES	GEG25ES-2RS	62000	310000	17	0.2030
30	55	32	20	34	GEG30ES	GEG30ES-2RS	80000	400000	17	0.3040
35	62	35	22	39	GEG35ES	GEG35ES-2RS	100000	500000	16	0.4080
40	68	40	25	44	GEG40ES	GEG40ES-2RS	127000	640000	17	0.5420
45	75	43	28	50	GEG45ES	GEG45ES-2RS	156000	780000	15	0.7130



Plain Type Series: **GE...E** and **GE...ES**

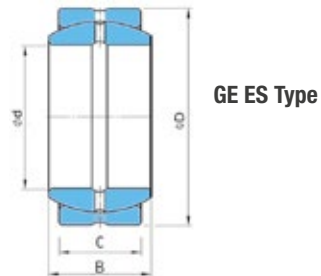
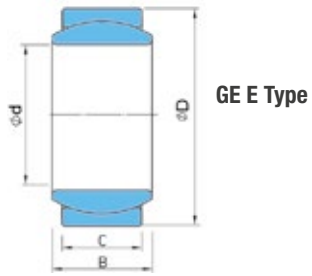

Principal dimensions					Designation	Basic Load Ratings		$\alpha \approx$	Mass	
d	D	B	C	d1min		Dynamic	Static			
mm						C	C ₀			
						N				kg
50	90	56	36	57	GEG50ES	GEG50ES-2RS	245000	1220000	17	1.44
60	105	63	40	67	GEG60ES	GEG60ES-2RS	315000	1560000	17	1.60
70	120	70	45	77	GEG70ES	GEG70ES-2RS	400000	2000000	16	3.01
80	130	75	50	87	GEG80ES	GEG80ES-2RS	490000	2450000	14	3.64
90	150	85	55	98	GEG90ES	GEG90ES-2RS	610000	3050000	15	5.22
100	160	85	55	110	GEG100ES	GEG100ES-2RS	655000	3250000	14	6.05
110	180	100	70	122	GEG110ES	GEG110ES-2RS	950000	4750000	12	9.68
120	210	115	70	132	GEG120ES	GEG120ES-2RS	1080000	5400000	16	14.72
140	230	130	80	151	GEG140ES	GEG140ES-2RS	1370000	6800000	16	19.01
160	260	135	80	176	GEG160ES	GEG160ES-2RS	1530000	7650000	16	20.02
180	290	155	100	196	GEG180ES	GEG160ES-2RS	2120000	10600000	14	32.21
200	320	165	100	220	GEG200ES	GEG200ES-2RS	2320000	11600000	15	45.28

Plain Type Series: **GEEW...ES**

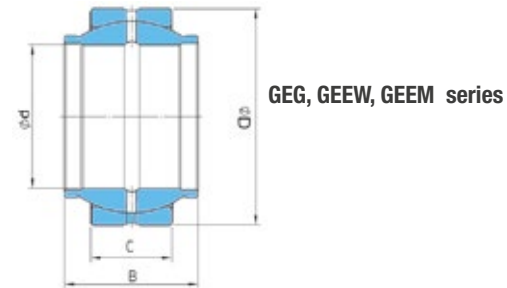

Principal dimensions					Designation	Basic Load Ratings		$\alpha \approx$	Mass	
d	D	B	C	d1min		Dynamic	Static			
mm						C	C ₀			
						N				kg
12	22	12	7	15.5	GEEW12ES	GEEW12ES-2RS	10000	54000	4	0.022
15	26	15	9	18.5	GEEW15ES	GEEW15ES-2RS	17000	85000	5	0.03
16	28	16	9	20	GEEW16ES	GEEW16ES-2RS	17000	85000	4	0.035
17	30	17	10	21	GEEW17ES	GEEW17ES-2RS	21000	106000	7	0.044
20	35	20	12	25	GEEW20ES	GEEW20ES-2RS	30000	146000	4	0.071
25	42	25	16	30.5	GEEW25ES	GEEW25ES-2RS	48000	240000	4	0.131
30	47	30	18	34	GEEW30ES	GEEW30ES-2RS	62000	310000	4	0.168
32	52	32	18	37	GEEW32ES	GEEW32ES-2RS	62000	310000	4	0.182
35	55	35	20	40	GEEW35ES	GEEW35ES-2RS	80000	400000	4	0.253
40	62	40	22	46	GEEW40ES	GEEW40ES-2RS	100000	500000	4	0.338
45	68	45	25	52	GEEW45ES	GEEW45ES-2RS	127000	640000	4	0.481
50	75	50	28	57	GEEW50ES	GEEW50ES-2RS	156000	780000	4	0.558
60	90	60	36	68	GEEW60ES	GEEW60ES-2RS	245000	1220000	3	1.150
63	95	63	36	71.5	GEEW63ES	GEEW63ES-2RS	245000	1220000	4	1.230
70	105	70	40	78	GEEW70ES	GEEW70ES-2RS	315000	1560000	4	1.710
80	120	80	45	91	GEEW80ES	GEEW80ES-2RS	400000	2000000	4	2.390
100	150	100	55	113	GEEW100ES	GEEW100ES-2RS	610000	3050000	4	4.800
125	180	125	70	138	GEEW125ES	GEEW125ES-2RS	950000	4750000	4	8.500



Plain Type Series: **GEEM...ES**

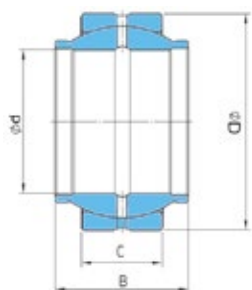

GEG, GEEW, GEEM series

Inner Bore d	Principal dimensions				Designation	Basic Load Ratings		$\alpha \approx$	Mass	
	D	B	C	d1min		Dynamic C	Static C ₀			
	mm					N				kg
20	35	24	12	24	GEEM20ES-2RS	30000	146000	6	0.073	
25	42	29	16	29	GEEM25ES-2RS	48000	240000	4	0.13	
30	47	30	18	34	GEEM30ES-2RS	62000	310000	4	0.17	
35	55	35	20	40	GEEM35ES-2RS	80000	400000	4	0.25	
40	62	38	22	45	GEEM40ES-2RS	100000	500000	4	0.35	
45	68	40	25	52	GEEM45ES-2RS	127000	640000	4	0.49	
50	75	43	28	57	GEEM50ES-2RS	156000	780000	4	0.60	
60	90	54	36	68	GEEM60ES-2RS	245000	1220000	3	1.15	
70	105	65	40	78	GEEM70ES-2RS	315000	1560000	4	1.65	
80	120	74	45	90	GEEM80ES-2RS	400000	2000000	4	2.50	

Plain Type Series: **GEZ...ES**

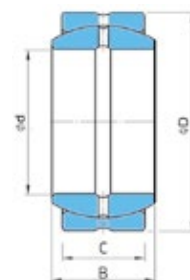

GEZ.. ES Series

Principal dimensions					Designation	Basic Load Ratings		$\alpha \approx$	Mass	
d	D	B	C	d1min		Dynamic C	Static C ₀			
mm						N				kg
12.7	22.225	11.1	9.525	14.1	GEZ12ES	13700	41500	6	0.022	
15.875	26.988	13.894	11.913	18.3	GEZ15ES	22000	65500	6	0.036	
19.05	31.75	16.662	14.275	21.8	GEZ19ES	31500	95000	6	0.053	
22.225	36.513	19.431	16.662	25.4	GEZ22ES	42500	127000	6	0.085	
25.4	41.275	22.225	19.05	27.6	GEZ25ES	56000	166000	6	0.121	
31.75	50.8	27.762	23.8	36	GEZ31ES	86500	260000	6	0.232	
34.925	55.563	30.15	26.187	38.6	GEZ34ES	102000	310000	6	0.351	
38.1	61.913	33.325	28.575	41.2	GEZ38ES	125000	375000	6	0.422	
44.45	71.438	38.887	33.325	50.7	GEZ44ES	170000	510000	6	0.641	
50.8	80.963	44.45	38.1	57.9	GEZ50ES	224000	670000	6	0.932	
57.15	90.488	50.013	42.85	64.9	GEZ57ES	280000	850000	6	1.33	
63.5	100.013	55.55	47.625	73.3	GEZ63ES	355000	1060000	6	1.85	
69.85	111.125	61.112	52.375	79.1	GEZ69ES	415000	1250000	6	2.42	
76.2	120.65	66.675	57.15	86.8	GEZ76ES	500000	1500000	6	3.10	
82.55	130.175	72.238	61.9	94.5	GEZ82ES	585000	1760000	6	3.82	
88.9	139.7	77.775	66.675	101.6	GEZ88ES	680000	2040000	6	4.79	
95.25	149.225	83.337	71.425	108.7	GEZ95ES	780000	2360000	6	5.78	
101.6	158.75	88.9	76.2	115.8	GEZ101ES	900000	2650000	6	6.99	
107.95	168.275	94.463	80.95	122.8	GEZ107ES	1000000	3000000	6	8.41	
114.3	177.8	100.013	85.725	130.6	GEZ114ES	1120000	3400000	6	9.79	
120.65	187.325	105.562	90.475	137.6	GEZ120ES	1250000	3750000	6	11.5	
127	196.85	111.125	95.25	145.3	GEZ127ES	1400000	4150000	6	13.5	
152.4	222.25	120.65	104.775	168.2	GEZ152ES	1730000	5200000	6	17.5	



Rod end Bearings



Rod end Bearings

Rod ends bearings are intended for linkage applications where a bearing must accommodate significant misalignment. Rod ends offer greater mounting convenience and provide a compact, lightweight, economical design KG offers the industry's widest selection of rod end types and sizes.

Series: **PHS**

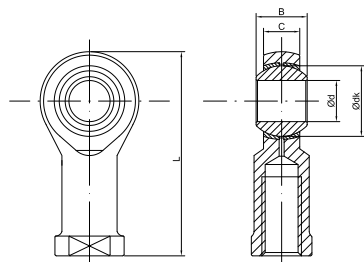

Principal dimensions					Designation	Basic Load Ratings		Mass
d	dk	L	B	C		Dynamic	Static	
mm						C	C ₀	
						N		
5	11.112	36	8	6	PHS5	3300	4100	0.016
6	12.7	40	9	6.75	PHS6	4300	5300	0.026
8	15.88	48	12	9	PHS8	6800	8500	0.044
10	19.05	57	14	10.5	PHS10	10000	11000	0.072
12	22.23	66	16	12	PHS12	13000	14000	0.108
14	25.4	75	19	13.5	PHS14	17000	20000	0.161
16	28.58	85	21	15	PHS16	21000	25000	0.225
18	31.75	93	23	16.5	PHS18	26000	30000	0.296
20	34.93	102	25	18	PHS20	31000	35000	0.385
22	38.1	111	28	20	PHS22	38000	43000	0.488
25	42.86	124	31	22	PHS25	47000	65000	0.749
28	47.63	136	35	25	PHS28	59000	77000	0.949
30	50.8	145	37	25	PHS30	63000	86000	1.130

Series: **PHS Left hand thread**

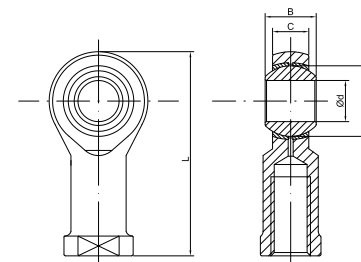

Principal dimensions					Designation	Basic Load Ratings		Mass
d	dk	L	B	C		Dynamic	Static	
mm						C	C ₀	
						N		
5	11.112	36	8	6	PHS5L	3300	4100	0.016
6	12.7	40	9	6.75	PHS6L	4300	5300	0.026
8	15.88	48	12	9	PHS8L	6800	8500	0.044
10	19.05	57	14	10.5	PHS10L	10000	11000	0.072
12	22.23	66	16	12	PHS12L	13000	14000	0.108
14	25.4	75	19	13.5	PHS14L	17000	20000	0.161
16	28.58	85	21	15	PHS16L	21000	25000	0.225
18	31.75	93	23	16.5	PHS18L	26000	30000	0.296
20	34.93	102	25	18	PHS20L	31000	35000	0.385
22	38.1	111	28	20	PHS22L	38000	43000	0.488
25	42.86	124	31	22	PHS25L	47000	65000	0.749
28	47.63	136	35	25	PHS28L	59000	77000	0.949
30	50.8	145	37	25	PHS30L	63000	86000	1.130

Series: **POS**

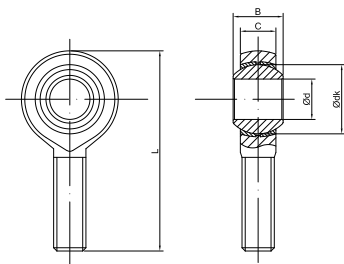

Principal dimensions					Designation	Basic Load Ratings		Mass
d	dk	L	B	C		Dynamic	Static	
mm						C	C ₀	
						N		
5	11.112	42	8	6	POS5	3300	4100	0.013
6	12.7	46	9	6.75	POS6	4300	5300	0.020
8	15.88	54	12	9	POS8	6800	8500	0.038
10	19.05	62	14	10.5	POS10	10000	11000	0.071
12	22.23	70	16	12	POS12	13000	14000	0.100
14	25.4	78	19	13.5	POS14	17000	20000	0.160
16	28.58	87	21	15	POS16	21000	25000	0.220
18	31.75	93	23	16.5	POS18	26000	30000	0.290
20	34.93	103	25	18	POS20	31000	35000	0.360
22	38.1	111	28	20	POS22	38000	43000	0.490
25	42.86	124	31	22	POS25	47000	65000	0.650
28	47.63	136	35	25	POS28	59000	77000	0.870
30	50.8	145	37	25	POS30	63000	86000	1.100

Series: **POS Left hand thread**

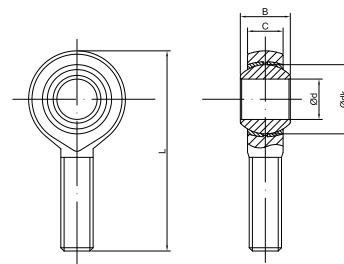

Principal dimensions					Designation	Basic Load Ratings		Mass
d	dk	L	B	C		Dynamic	Static	
mm						C	C ₀	
						N		
5	11.112	42	8	6	POS5L	3300	4100	0.013
6	12.7	46	9	6.75	POS6L	4300	5300	0.020
8	15.88	54	12	9	POS8L	6800	8500	0.038
10	19.05	62	14	10.5	POS10L	10000	11000	0.071
12	22.23	70	16	12	POS12L	13000	14000	0.100
14	25.4	78	19	13.5	POS14L	17000	20000	0.160
16	28.58	87	21	15	POS16L	21000	25000	0.220
18	31.75	93	23	16.5	POS18L	26000	30000	0.290
20	34.93	103	25	18	POS20L	31000	35000	0.360
22	38.1	111	28	20	POS22L	38000	43000	0.490
25	42.86	124	31	22	POS25L	47000	65000	0.650
28	47.63	136	35	25	POS28L	59000	77000	0.870
30	50.8	145	37	25	POS30L	63000	86000	1.100

Linear Motion Ball Bearings



Linear Motion Ball Bearings (LM)

The linear ball bearing (also called ball bushing or shaft guiding) consists of a polymeric cage with raceway segments made of hardened steel to guide the ball sets within the complete system. Reticulating balls provide unlimited stroke at low friction movement.

KG offers range of Linear Motion Ball Bearings.



Series: **LM**

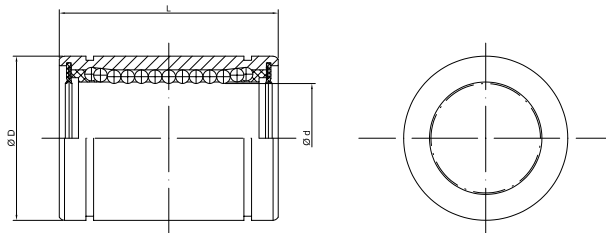

Principal dimensions			Designation	Basic Load Ratings		Mass kg
d	D	L		Dynamic	Static	
mm				C	C ₀	
				N		
3	7	10	LM3UU	88	108	0.0014
4	8	12	LMU4UU	88	127	0.0019
5	10	15	LM5UU	167	206	0.004
6	12	19	LM6UU	206	265	0.008
8	15	24	LM8UU	274	392	0.015
10	19	29	LM10UU	372	549	0.030
12	21	30	LM12UU	510	784	0.032
13	23	32	LM13UU	510	784	0.043
16	28	37	LM16UU	774	1180	0.069
20	32	42	LM20UU	882	1370	0.087
25	40	59	LM25UU	980	1570	0.220
30	45	64	LM30UU	1570	2740	0.250
35	52	70	LM35UU	1670	3140	0.390
40	60	80	LM40UU	2160	4020	0.585
50	80	100	LM50UU	3820	7940	1.580
60	90	110	LM60UU	4700	10000	1.860
80	120	140	LM80UU	7350	16000	4.420
100	150	175	LM100UU	14100	34800	8.600
120	180	200	LM120UU	16400	40000	15.000
150	210	240	LM150UU	21100	54300	20.250

Series: **LME**

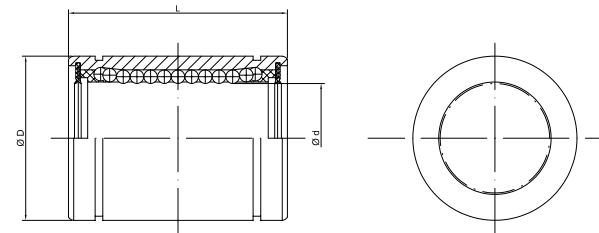

Principal dimensions			Designation	Basic Load Ratings		Mass kg
d	D	L		Dynamic	Static	
mm				C	C ₀	
				N		
5	12	22	LME5UU	206	265	0.011
8	16	25	LME8UU	265	402	0.020
10	19	29	LME10UU	372	549	0.030
12	22	32	LME12UU	510	784	0.041
16	26	36	LME16UU	578	892	0.057
20	32	45	LME20UU	862	1370	0.091
25	40	58	LME25UU	980	1570	0.215
30	47	68	LME30UU	1570	2740	0.325
40	62	80	LME40UU	2160	4020	0.705
50	75	100	LME50UU	3820	7940	1.130
60	90	125	LME60UU	4700	9800	2.000



Thrust Ball, Cylindrical Roller, Spherical Roller Bearings



Thrust Ball, Cylindrical Roller, Spherical Roller Bearings

Thrust bearings are designed to support a predominantly axial load, depending up on type of rolling elements it is classified as Thrust ball bearings, composed of bearing balls supported in a ring, Thrust Cylindrical roller bearings, consist of Cylindrical rollers, Thrust Spherical roller bearings consist of asymmetrical rollers of spherical shape

Rolling elements s are arranged between a set of washers (a shaft washer and housing washer) and the contact angle is 90° .



Thrust Ball Bearings

Thrust Ball Bearings are separable axial bearings that are produced in both single and double direction acting design. To assist in simple effective mounting or dismounting the bearing washers, seating's, and cage and ball assemblies, may be individually mounted in their arrangement location.

Thrust ball bearings may accommodate comparatively high axial loads but they must not be exposed to any radial forces.

Thrust ball bearings are only suitable for low to medium operating speeds, they require minimum axial loads for their optimum function.

Since thrust ball bearings do not compensate any misalignment, they are also frequently used in conjunction with sphered housing washers and seating washers.

Thrust ball bearings are produced in both, single direction and double direction design.

Single direction thrust ball bearings consist of a shaft washer, a housing washer and a ball and cage (thrust assembly figure a and b of next page). These bearings are able to accommodate axial loads in one direction only. Single direction thrust ball bearings of series 511, 512, 513 and 514 have plain (figure a) and sphered housing (figure b).

Double direction thrust ball bearings are suitable to guide the shaft in both directions (see figure d and e of next page). These bearings consist of two washers, two ball and cage thrust assemblies with one common shaft washer located centrally in between. Double direction thrust ball bearings are also available in both designs, with flat housing washers (figure d) and sphered housing washers (figure e).

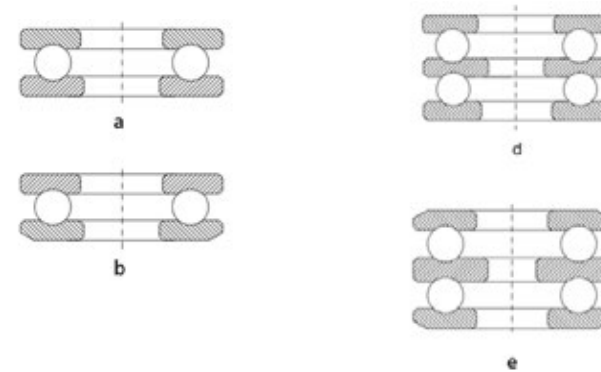

Thrust Ball Bearings are

- Capable of carrying only axial loads in one direction or two-directions based on the type selected
- Suitable for low and medium load applications
- Suitable for low and medium speed applications

KG can offer following variants

- Single Direction Thrust Ball Bearing - 511, 512, 513 and 514
- Double Direction Thrust Ball Bearing - 522, 523 and 524
- Single Direction with Spherical Housing Washer - 532,533 and 534

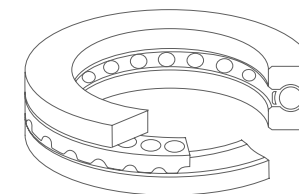

Thrust Cylindrical Roller Bearings

Cylindrical roller thrust bearings are insensitive to shock loading and feature much higher load carrying capacity compared to thrust ball bearings. They accommodate very high axial loads but no radial forces. They provide a very rigid bearing assembly for high thrust loading with less space requirement.

Thrust Cylindrical Roller Bearings are

- Simple design with easy installation
- Suitable for medium and high load applications
- Suitable for medium speed applications

Cylindrical roller thrust bearings are of simple design, they consist of a shaft washer (WS), a housing washer (GS), and a cylindrical roller.

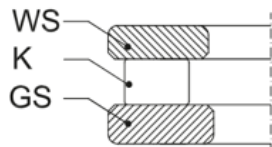

Thrust Spherical Roller Bearings

Thrust roller bearings sustain only axial loads, but they are suitable for heavy loads and have high axial rigidity. Spherical thrust roller bearings contain convex rollers and have a self-aligning capability and are free of any influence of mounting error or shaft deflection. Standard cages are machined brass, pressed cage for high load capacity.

Thrust Spherical Roller Bearings are

- Spherically contoured rollers, arranged in a steep angular position, accommodate high thrust loads and support moderate radial loads.
- Bearing geometry and manufacturing technology result in low friction of bearing.
- Internal self-alignment of bearing elements during operation compensates for shaft deflections and housing distortions caused by shock or heavy loads.

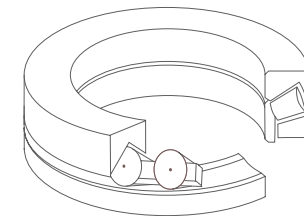

KG standard suffixes for Thrust Bearings

A	Modified internal design.
M	Machined Brass Cage.
P or TN	Plastic / Polyamide / Nylon Cage.
Q1-Q3	KG internal reference codes. For details please contact KG International FZCO.
SC	Special Cage design.

Note: Most of the Bearings listed in the following pages of this chapter are available with above suffixes, subject to design or manufacturing constraints.



Single Direction Series: 511

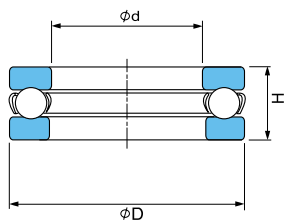

Principal dimensions			Designation	Basic Load Ratings		Speed ratings		Mass
d	D	H		Dynamic	Static	Reference speed	Limiting speed	
mm				C	C ₀	r/min		
				N		r/min		
10	24	9	51100	9950	15300	9,500	13,000	0.02
12	26	9	51101	10400	16600	9,000	13,000	0.02
15	28	9	51102	10600	18300	8,500	12,000	0.02
17	30	9	51103	11400	21200	8,500	12,000	0.03
20	35	10	51104	15100	29000	7,500	10,000	0.04
25	42	11	51105	18200	39000	6,300	9,000	0.06
30	47	11	51106	19000	43000	6,000	8,500	0.06
35	52	12	51107	19900	51000	5,600	7,500	0.08
40	60	13	51108	25500	63000	5,000	7,000	0.12
45	65	14	51109	26500	69500	4,500	6,300	0.14
50	70	14	51110	27000	75000	4,300	6,300	0.16
55	78	16	51111	30200	81500	3,800	5,300	0.23
60	85	17	51112	41600	122000	3,600	5,000	0.27
65	90	18	51113	37700	108000	3,400	4,800	0.33
70	95	18	51114	40300	120000	3,400	4,500	0.35
75	100	19	51115	44200	134000	3,200	4,300	0.40
80	105	19	51116	44900	140000	3,000	4,300	0.42
85	110	19	51117	44900	146000	3,000	4,300	0.44
90	120	22	51118	59200	208000	2,600	3,800	0.67
100	135	25	51120	80600	265000	2,400	3,200	0.97

Single Direction Series: 511

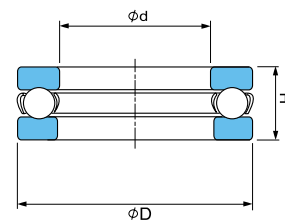

Principal dimensions			Designation	Basic Load Ratings		Speed ratings		Mass
d	D	H		Dynamic	Static	Reference speed	Limiting speed	
mm				C	C ₀	r/min		
				N		r/min		
110	145	25	51122	83200	285000	2,200	3,200	1.05
120	155	25	51124	85200	305000	2,200	3,000	1.15
130	170	30	51126	119000	440000	1,900	2,600	1.85
140	180	31	51128	111000	440000	1,800	2,600	2.05
150	190	31	51130	111000	440000	1,700	2,400	2.20
160	200	31	51132	112000	465000	1,700	2,400	2.35
170	215	34	51134	133000	540000	1,600	2,200	3.30
180	225	34	51136	135000	570000	1,500	2,200	3.50
190	240	37	51138	172000	710000	1,400	2,000	4.05
200	250	37	51140	168000	710000	1,400	1,900	4.25
220	270	37	51144	178000	800000	1,300	1,900	4.60
240	300	45	51148	234000	1040	1,100	1,600	7.55
260	320	45	51152	238000	1100	1,100	1,500	8.10
280	350	53	51156	319000	1460	950	1,300	12.00
300	380	62	51160	364000	1760	850	1,200	17.50
320	400	63	51164	371000	1860	800	1,100	19.00
340	420	64	51168	377000	1960	800	1,100	20.50
360	440	65	51172	390000	2080	750	1,000	22.00
380	460	65	51176	397000	2200	750	1,000	23.00
400	480	65	51180	403000	2280	700	1,000	24.00



Single Direction Series: 512

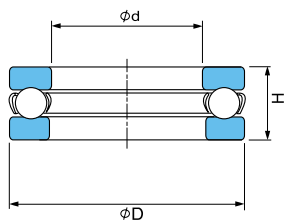

Principal dimensions			Designation	Basic Load Ratings		Speed ratings		Mass
d	D	H		Dynamic	Static	Reference speed	Limiting speed	
mm				C	C ₀	r/min		
				N		r/min		
10	26	11	51200	12700	18600	8,000	11,000	0.03
12	28	11	51201	13300	20800	8,000	11,000	0.03
15	32	12	51202	15900	25000	7,000	10,000	0.05
17	35	12	51203	16300	27000	6,700	9,500	0.05
20	40	14	51204	21200	37500	6,000	8,000	0.08
25	47	15	51205	26500	50000	5,300	7,500	0.11
30	52	16	51206	25100	51000	4,800	6,700	0.13
35	62	18	51207	35100	73500	4,000	5,600	0.22
40	68	19	51208	44200	96500	3,800	5,300	0.28
45	73	20	51209	39000	86500	3,600	5,000	0.30
50	78	22	51210	49400	116000	3,400	4,500	0.37
55	90	25	51211	58500	134000	2,800	4,000	0.59
60	95	26	51212	59200	140000	2,800	3,800	0.65
65	100	27	51213	60500	150000	2,600	3,600	0.72
70	105	27	51214	62400	160000	2,600	3,600	0.79
75	110	27	51215	63700	170000	2,400	3,400	0.83
80	115	28	51216	76100	208000	2,400	3,400	0.91
85	125	31	51217	97500	275000	2,200	3,000	1.20

Single Direction Series: 512

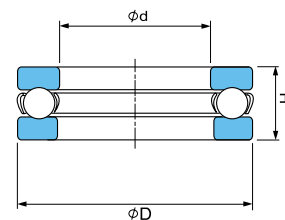

Principal dimensions			Designation	Basic Load Ratings		Speed ratings		Mass
d	D	H		Dynamic	Static	Reference speed	Limiting speed	
mm				C	C ₀	r/min		
				N		r/min		
90	135	35	51218	112000	290000	2,000	2,800	1.70
100	150	38	51220	119000	325000	1,800	2,400	2.20
110	160	38	51222	125000	365000	1,700	2,400	2.40
120	170	39	51224	127000	390000	1,600	2,200	2.65
130	190	45	51226	186000	585000	1,400	2,000	4.00
140	200	46	51228	190000	620000	1,400	1,900	4.35
150	215	50	51230	238000	800000	1,300	1,800	6.10
160	225	51	51232	238000	830000	1,200	1,700	6.55
170	240	51	51234	270000	930000	1,200	1,700	8.15
180	250	51	51236	302000	1120	1,200	1,600	8.60
190	270	51	51238	332000	1270	1,100	1,600	12.00
200	280	51	51240	338000	1320	1,100	1,500	12.00
220	300	63	51244	358000	1460	950	1,300	13.00
240	340	78	51248	449000	1960	800	1,100	23.00
260	360	79	51252	488000	2240	750	1,100	25.00
280	380	80	51256	488000	2320	750	1,000	26.50
300	420	95	51260	585000	3000	630	850	42.00



Single Direction Series: 513

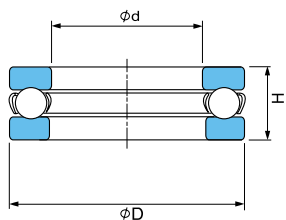

Principal dimensions			Designation	Basic Load Ratings		Speed ratings		Mass
d	D	H		Dynamic	Static	Reference speed	Limiting speed	
mm				C	C ₀	r/min	r/min	
				N				
25	52	18	51305	34500	60000	4,500	6,300	0.17
30	60	21	51306	35800	65500	3,800	5,300	0.26
35	68	24	51307	49400	96500	3,400	4,800	0.39
40	78	26	51308	61800	122000	3,000	4,300	0.53
45	85	28	51309	76100	153000	2,800	4,000	0.66
50	95	31	51310	81900	170000	2,600	3,600	0.94
55	105	35	51311	101000	224000	2,200	3,200	1.30
60	110	35	51312	101000	224000	2,200	3,000	1.35
65	115	36	51313	106000	240000	2,000	3,000	1.50
70	125	40	51314	135000	320000	1,900	2,600	2.00
75	135	44	51315	163000	390000	1,700	2,400	2.60
80	140	44	51316	159000	390000	1,700	2,400	2.70
85	150	49	51317	174000	405000	1,600	2,200	3.55
90	155	50	51318	182000	440000	1,500	2,200	3.80
100	170	55	51320	225000	570000	1,400	1,900	4.95
110	190	63,5	51322	281000	815000	1,200	1,700	7.85
120	210	70	51324	325000	980000	1,100	1,500	11.00
130	225	75	51326	358000	1140	1,000	1,400	13.00
140	240	80	51328	377000	1220	950	1,300	15.50
150	250	80	51330	390000	1290	900	1,300	16.50
160	270	87	51332	449000	1660	850	1,200	21.00
170	280	87	51334	468000	1760	800	1,100	22.00
180	300	95	51336	520000	2000	750	1,100	28.50
190	320	105	51338	559000	2200	700	950	36.50
200	340	110	51340	624000	2600	630	900	44.50

Single Direction Series: 514

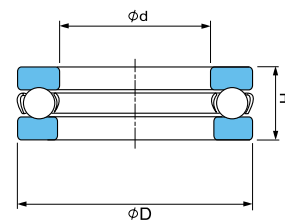

Principal dimensions			Designation	Basic Load Ratings		Speed ratings		Mass
d	D	H		Dynamic	Static	Reference speed	Limiting speed	
mm				C	C ₀	r/min	r/min	
				N				
25	60	24	51405	42300	67000	3,600	5,000	0.34
30	70	28	51406	70200	122000	3,000	4,300	0.52
35	90	32	51407	76100	137000	2,600	3,600	0.79
40	90	36	51408	95600	183000	2,400	3,400	1.10
45	100	39	51409	124000	240000	2,200	3,000	1.40
50	110	43	51410	159000	340000	2,000	2,800	2.00
55	120	48	51411	195000	400000	1,800	2,400	2.55
60	130	51	51412	199000	430000	1,600	2,200	3.10
65	140	56	51413	216000	490000	1,500	2,200	4.00
70	150	60	51414	234000	550000	1,400	2,000	5.00
75	160	65	51415	251000	610000	1,300	1,800	6.75
80	170	68	51416	302000	750000	1,200	1,700	7.95
85	180	72	51417	286000	750000	1,200	1,600	9.45
90	190	77	51418	307000	815000	1,100	1,500	11.00
100	210	85	51420	371000	1060	950	1,400	15.00
110	230	95	51422	410000	1220	900	1,300	20.00
120	250	102	51424	432000	1320	800	1,100	25.50
130	270	110	51426	520000	1730	750	1,000	32.00
140	280	112	51428	520000	1730	700	1,000	34.50
150	300	120	51430	559000	1960	670	950	42.50



Double Direction Series: 522

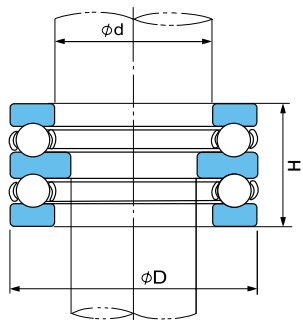

Principal dimensions			Designation	Basic Load Ratings		Speed ratings		Mass
d	D	H		Dynamic	Static	Reference speed	Limiting speed	
mm				C	C_0	r/min		
				N				
10	32	22	52202	15900	25000	7,000	10,000	0.08
15	40	26	52204	21200	37500	4,300	6,000	0.15
20	47	28	52205	26500	50000	3,800	5,300	0.22
25	52	29	52206	24700	46500	3,600	5,000	0.25
30	62	34	52207	35100	73500	3,000	4,300	0.41
30	68	36	52208	44200	96500	2,800	3,800	0.55
35	73	37	52209	39000	86500	2,600	3,600	0.60
40	78	39	52210	49400	116000	2,400	3,400	0.71
45	90	45	52211	58500	134000	2,200	3,000	1.10
50	95	46	52212	59200	140000	2,000	2,800	1.20
55	100	47	52213	60500	150000	2,000	2,800	1.35
55	105	47	52214	62400	160000	1,900	2,600	1.50
60	110	47	52215	63700	170000	1,900	2,600	1.55
65	115	48	52216	76100	208000	2,400	3,400	1.70
70	125	55	52217	97500	275000	1,600	2,200	2.40
75	135	62	52218	112000	290000	1,500	2,000	3.20
85	150	67	52220	119000	325000	1,300	1,800	4.20

Double Direction Series: 523

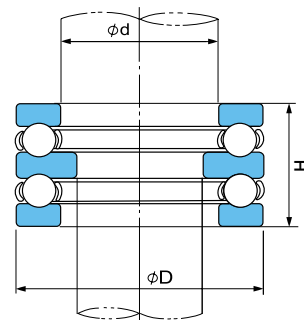

Principal dimensions			Designation	Basic Load Ratings		Speed ratings		Mass
d	D	H		Dynamic	Static	Reference speed	Limiting speed	
mm				C	C_0	r/min		
				N				
20	52	34	52305	34500	60000	3,200	4,500	0.33
25	60	38	52306	35800	65500	2,800	4,000	0.47
30	68	44	52307	49400	96500	2,400	3,400	0.68
30	78	49	52308	61800	122000	2,200	3,000	1.05
35	85	52	52309	76100	153000	2,000	2,800	1.25
40	95	58	52310	81900	170000	1,800	2,600	1.75
45	105	64	52311	101000	224000	1,600	2,200	2.40
50	110	64	52312	101000	224000	1,600	2,200	2.55
55	115	64	52313	106000	240000	1,600	2,200	2.75
55	125	72	52314	135000	320000	1,400	2,000	3.65
60	135	79	52315	163000	390000	1,300	1,800	4.80
65	140	79	52316	159000	390000	1,300	1,800	4.95
85	170	97	52320	225000	570000	1,000	1,400	8.95



Single Direction Series: 524

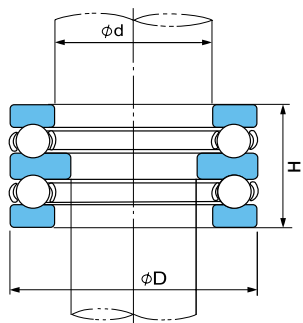

Principal dimensions			Designation	Basic Load Ratings		Speed ratings		Mass
d	D	H		Dynamic	Static	Reference speed	Limiting speed	
mm				C	C ₀	r/min		
				N				
20	70	52	52406	70200	122000	2,200	3,200	1.00
25	80	59	52407	76100	137000	2,000	2,800	1.45
30	90	65	52408	95600	183000	1,800	2,400	2.05
35	100	72	52409	124000	240000	1,600	2,200	2.70
45	120	87	52411	195000	400000	1,300	1,800	4.70
50	130	93	52412	199000	430000	1,200	1,700	6.35
55	250	107	52414	234000	550000	800	1,100	9.70

Single Direction With Spherical Housing Washer Series: 532

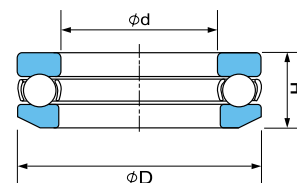

Principal dimensions			Designation	Basic Load Ratings		Speed ratings		Mass
d	D	H		Dynamic	Static	Reference speed	Limiting speed	
mm				C	C ₀	r/min		
				N				
15	32	15	53202	15900	25000	7,000	10,000	0.06
17	35	15	53203	16300	27000	6,700	9,500	0.07
20	40	17	53204	21200	37500	5,600	8,000	0.10
25	47	19	53205	26500	50000	5,000	7,000	0.15
30	52	20	53206	25100	51000	4,500	6,300	0.18
35	62	22	53207	35100	73500	4,000	5,600	0.28
40	68	23	53208	44200	96500	3,600	5,300	0.35
45	73	24	53209	39000	86500	3,400	4,800	0.39
50	78	26	53210	49400	116000	3,200	4,500	0.47
55	90	30	53211	58500	134000	2,800	3,800	0.75
60	95	31	53212	59200	140000	2,600	3,600	0.82
65	100	32	53213	60500	150000	2,600	3,600	0.91
70	105	32	53214	62400	160000	2,600	3,600	0.97
75	110	32	53215	63700	170000	2,400	3,400	1.00
80	115	33	53216	76100	208000	2,400	3,200	1.10
85	125	37	53217	97500	275000	2,000	3,000	1.50
90	135	42	53218	112000	290000	1,900	2,600	2.10
100	150	45	53220	119000	325000	1,700	2,400	2.70



Single Direction With Spherical Housing Washer Series: 533

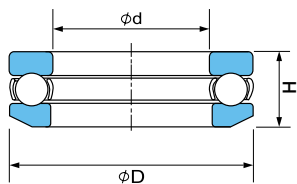

Principal dimensions			Designation	Basic Load Ratings		Speed ratings		Mass
d	D	H		Dynamic	Static	Reference speed	Limiting speed	
mm				C	C ₀	r/min		
				N				
30	60	25	53306	35800	65500	3,800	5,300	0.330
35	68	28	53307	49400	96500	3,200	4,500	0.460
40	78	31	53308	61800	122000	2,800	4,000	0.670
45	85	33	53309	76100	153000	2,600	3,800	0.830
50	95	37	53310	81900	170000	2,400	3,400	1.20
55	105	42	53311	101000	224000	2,200	3,000	1.70
60	110	42	53312	101000	224000	2,000	3,000	1.70
65	115	43	53313	106000	240000	2,000	2,800	1.90
70	125	48	53314	135000	320000	1,800	2,600	2.50
75	135	52	53315	163000	390000	1,700	2,400	3.20
80	140	52	53316	159000	390000	1,600	2,200	3.20
85	150	58	53317	174000	405000	1,500	2,000	4.35
90	155	59	53318	182000	440000	1,400	2,000	4.70
100	170	64	53320	225000	570000	1,300	1,800	5.95

Single Direction With Spherical Housing Washer Series: 534

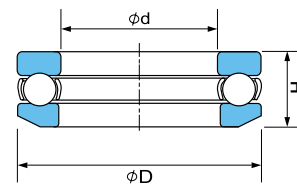

Principal dimensions			Designation	Basic Load Ratings		Speed ratings		Mass
d	D	H		Dynamic	Static	Reference speed	Limiting speed	
mm				C	C ₀	r/min		
				N				
40	90	42	53408	95600	183000	2,400	3,200	1.35
50	110	50	53410	159000	340000	1,900	2,600	2.30
55	120	55	53411	195000	400000	1,700	2,400	3.10
60	130	58	53412	199000	430000	1,600	2,200	3.80
70	150	69	53414	234000	550000	1,400	2,000	6.50
75	160	75	53415	251000	610000	1,300	1,800	8.10
90	190	88	53418	307000	815000	1,100	1,500	13.00
100	210	98	53420	371000	1060	950	1,300	18.00



Thrust Ball Bearing Inch series

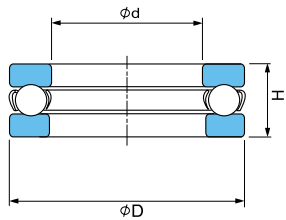

Principal dimensions			Designation	Basic Load Ratings		Speed ratings		Mass
d	D	H		Dynamic	Static	Reference speed	Limiting speed	
mm				C	C ₀	r/min		
				N				
9.525	25.400	13.494	0 - 3	11800	15200	5,500	8,100	0.036
12.700	32.544	15.875	0 - 4	18600	25100	4,300	6,500	0.077
15.875	35.719	15.875	0 - 5	19400	28300	4,100	6,200	0.086
19.050	38.894	15.875	0 - 6	21400	34500	4,000	6,000	0.095
22.225	42.069	15.875	0 - 7	21900	37500	3,800	5,800	0.100
25.400	45.244	15.875	0 - 8	22500	41000	3,700	5,500	0.110
28.575	48.419	15.875	0 - 9	24100	47000	3,600	5,400	0.128
31.750	53.181	18.256	0 - 10	27900	54500	3,200	4,800	0.164
34.925	56.356	18.256	0 - 11	28600	58300	3,100	4,600	0.186
38.100	59.531	18.256	0 - 12	29500	66300	3,000	4,500	0.200
41.275	62.706	18.256	0 - 13	26700	68000	2,900	4,400	0.210
44.450	68.262	19.050	0 - 14	32500	77500	2,700	4,100	0.260
47.625	71.438	19.050	0 - 15	37500	89300	2,700	4,000	0.285
50.800	75.406	19.050	0 - 16	38800	94300	2,600	3,900	0.300
53.975	81.756	22.225	0 - 17	49500	118000	2,300	3,500	0.405

Thrust Ball Bearing Inch series

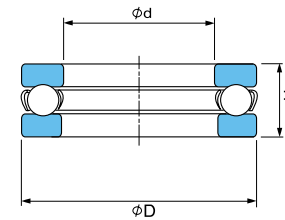

Principal dimensions			Designation	Basic Load Ratings		Speed ratings		Mass
d	D	H		Dynamic	Static	Reference speed	Limiting speed	
mm				C	C ₀	r/min		
				N				
57.150	84.931	22.225	0 - 18	54500	125000	2,300	3,400	0.450
60.325	91.281	25.400	0 - 19	58000	145000	2,000	3,100	0.590
63.500	94.456	25.400	0 - 20	59500	152000	2,000	3,000	0.610
66.675	97.631	25.400	0 - 21	60500	160000	2,000	3,000	0.660
69.850	102.394	25.400	0 - 22	71500	179000	1,900	2,900	0.700
73.025	105.569	25.400	0 - 23	75500	199 000	1,900	2,800	0.730
76.200	111.125	28.575	0 - 24	77000	209000	1,700	2,600	0.900
82.550	122.238	31.750	0 - 26	97500	209000	1,600	2,400	1.300
88.900	128.588	31.750	0 - 28	99300	266000	1,500	2,300	1.320
95.250	134.938	31.750	0 - 30	98500	289000	1,500	2,200	1.360
101.600	147.638	34.925	0 - 32	113000	310000	1,300	2,000	1.880
114.3	166.688	44.45	0 - 36	157000	435000	1,100	1,700	3.18
127.3	185.738	50.8	0 - 40	193000	545000	1,000	1,500	4.54
139.7	204.788	55.562	0 - 44	248000	753000	910	1,300	5.9
152.4	220.662	60.325	0 - 48	269000	805000	830	1,200	7.25



Thrust Cylindrical Roller Bearings Series: 811/812

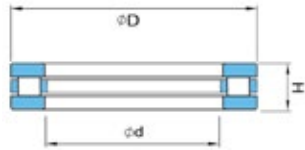

Principal dimensions			Designation	Basic Load Ratings		Speed ratings		Mass
d	D	H		Dynamic	Static	Reference speed	Limiting speed	
mm				C	C ₀	Grease	Oil	
				N		r/min		
30	47	11	81106	28000	83000	2,600	6,700	0.06
30	52	16	81206	50000	132000	2,400	6,300	0.13
35	52	12	81107	30000	93000	2,200	6,000	0.08
35	62	18	81207	54000	156000	1,900	5,300	0.23
40	60	13	81108	42500	137000	1,900	5,300	0.12
40	68	19	81208	76500	220000	1,700	4,800	0.27
45	65	14	81109	45000	150000	1,700	4,800	0.14
45	73	20	81209	83000	255000	1,600	4,500	0.31
50	70	14	81110	42500	143000	1,500	4,300	0.16
50	78	22	81210	88000	285000	1,400	4,000	0.38
55	78	16	81111	52000	193000	1,400	4,000	0.23
55	90	25	81211	122000	390000	1,200	3,600	0.6
60	85	17	81112	73500	265000	1,200	3,600	0.28
60	95	26	81212	114000	335000	1,100	3,400	0.74
65	90	18	81113	76500	285000	1,100	3,400	0.33
65	100	27	81213	118000	390000	950	3,000	0.82
70	95	18	81114	71000	265000	1,000	3,200	0.36
70	105	27	81214	122000	440000	950	3,000	0.87
75	100	19	81115	75000	285000	950	3,000	0.43
75	110	27	81215	125000	440000	900	2,800	0.92
80	105	19	81116	76500	300000	900	2,800	0.46
80	115	28	81216	129000	455000	850	2,600	1.02
85	110	19	81117	76500	310000	850	2,600	0.48
85	125	31	81217	153000	550000	800	2,400	1.36
90	120	22	81118	104000	415000	800	2,400	0.72
90	135	35	81218	190000	670000	800	2,400	1.85
100	135	25	81120	146000	585000	750	2,200	1.07
100	150	38	81220	224000	815000	700	2,000	2.45
110	145	25	81122	160000	655000	700	2,000	1.12
110	160	38	81222	232000	865000	670	1,900	2.7
120	155	25	81124	160000	680000	670	1,900	1.25
120	170	39	81224	245000	950000	630	1,800	2.98

Thrust Cylindrical Roller Bearings Series: 811/812

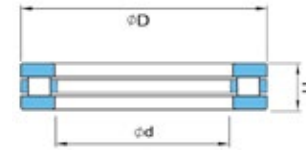

Principal dimensions			Designation	Basic Load Ratings		Speed ratings		Mass
d	D	H		Dynamic	Static	Reference speed	Limiting speed	
mm				C	C ₀	Grease	Oil	
				N		r/min		
130	170	30	81126	186000	780000	600	1,700	1.72
130	190	45	81226	365000	1400000	560	1,600	4.37
140	180	31	81128	196000	865000	560	1,600	2.02
140	200	46	81228	375000	1460000	530	1,500	4.76
150	190	31	81130	204000	930000	530	1,500	2.15
150	215	50	81230	455000	1800000	500	1,400	6.04
160	200	31	81132	212000	980000	500	1,400	2.28
160	225	51	81232	465000	1900000	500	1,400	6.52
170	215	34	81134	265000	1220000	500	1,400	3.01
170	240	55	81234	520000	2080000	480	1,300	8.12
180	225	34	81136	275000	1290000	480	1,300	3.07
180	250	56	81236	520000	2160000	450	1,200	8.69
190	240	37	81138	315000	1500000	450	1,200	3.99
190	270	62	81238	655000	2650000	430	1,100	11.7
200	250	37	81140	325000	1600000	450	1,200	4.17
200	280	62	81240	695000	2900000	430	1,100	12.2
220	270	37	81144	355000	1830000	430	1,100	4.65
220	300	63	81244	735000	3200000	400	1,000	12.2
240	300	45	81148	465000	2360000	380	950	4.65
240	340	78	81248	980000	4250000	360	900	13.4
260	320	45	81152	500000	2650000	360	900	7.99
260	360	79	81252	1040000	4650000	340	850	25.1
280	350	53	81156	670000	3450000	340	850	12
280	380	80	81256	1060000	4900000	320	800	27.1
300	380	62	81160	800000	4000000	300	750	17.2
300	420	95	81260	1400000	6200000	280	700	42.5
360	440	65	81172	900000	4900000	240	630	21.4
360	500	110	81272	1960000	9150000	220	600	68.7
380	460	65	81176	880000	4900000	240	630	22.4
380	520	112	81276	2000000	9500000	200	560	73.3



Thrust Spherical Roller Bearings Series: 292

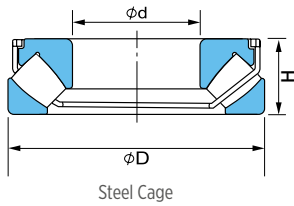

Principal dimensions			Designation	Basic Load Ratings		Speed ratings		Mass kg
d	D	H		Dynamic C	Static C ₀	Reference speed	Limiting speed	
mm				N		r/min		
150	215	39		29230	408	1600	1,800	
180	250	42	29236	495	2040	1,600	2,600	5.8
200	280	48	29240	656	2650	1,400	2,200	9.3
220	300	48	29244	690	3000	1,300	2,200	10.0
240	340	60	29248	799	3450	1,100	1,800	16.5
260	360	60	29252	817	3650	1,100	1,700	18.5
280	380	60	29256	863	4000	1,000	1,700	19.5
300	420	73	29260	1070	4800	900	1,400	30.5
320	440	73	29264	1110	5100	850	1,400	33.0
340	460	73	29268	1130	5400	850	1,300	33.5
360	500	85	29272	1460	6800	750	1,200	52.0
380	520	85	29276	1580	7650	700	1,100	53.0
400	540	85	29280	1610	8000	700	1,100	55.5
420	580	95	29284	1990	9800	630	1,000	75.5
440	600	95	29288	2070	10400	630	1,000	78.0
460	620	95	29292	2070	10600	600	950	81.0
480	650	103	29296	2350	11800	560	900	98.0
500	670	103	292/500	2390	12500	560	900	100.0

Thrust Spherical Roller Bearings Series: 293

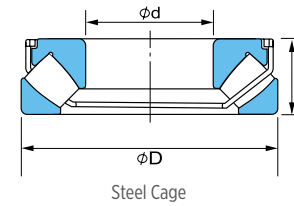

Principal dimensions			Designation	Basic Load Ratings		Speed ratings		Mass kg
d	D	H		Dynamic C	Static C ₀	Reference speed	Limiting speed	
mm				N		r/min		
85	150	39		29317	380	1060	2,400	
90	155	39	29318	400	1080	2,400	4,000	2.85
100	170	42	29320	465	1290	2,200	3,600	3.65
110	190	48	29322	610	1730	1,900	3,200	5.30
120	210	54	29324	765	2120	1,700	2,800	7.35
130	225	58	29326	865	2500	1,600	2,600	9.00
140	240	60	29328	980	2850	1,500	2,600	10.50
150	250	60	29330	1000	2850	1,500	2,400	11.00
160	270	67	29332	1180	3450	1,300	2,200	14.50
170	280	67	29334	1200	3550	1,300	2,200	15.00
180	300	73	29336	1430	4300	1,200	2,000	19.50
190	320	78	29338	1630	4750	1,100	1,900	23.50
200	340	85	29340	1860	5500	1,000	1,700	28.50
220	360	85	29344	2000	6300	1,000	1,700	31.00
240	380	85	29348	2040	6550	1,000	1,600	35.50
260	420	95	29352	2550	8300	850	1,400	49.00
280	440	95	29356	2550	8650	850	1,400	53.00
300	480	109	29360	3100	10600	750	1,200	75.00



Series: **294**

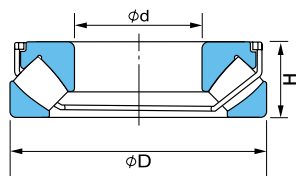

Steel Cage

Principal dimensions			Designation	Basic Load Ratings		Speed ratings		Mass
d	D	H		Dynamic	Static	Reference speed	Limiting speed	
mm				C	C ₀	r/min	kg	
				N				
60	130	42	29412	390	915	2,800	5,000	2.6
65	140	45	29413	455	1080	2,600	4,800	3.2
70	150	48	29414	520	1250	2,400	4,300	3.9
75	160	51	29415	600	1430	2,400	4,000	4.7
80	170	54	29416	670	1630	2,200	3,800	5.6
85	180	58	29417	735	1800	2,000	3,600	6.8
90	190	60	29418	815	2000	1,900	3,400	7.8
100	210	67	29420	980	2500	1,700	3,000	10.5
110	230	73	29422	1180	3000	1,600	2,800	13.5
120	250	78	29424	1370	3450	1,500	2,600	17.5
130	270	85	29426	1560	4050	1,300	2,400	22.0
140	280	85	29428	1630	4300	1,300	2,400	23.0
150	300	90	29430	1860	5100	1,200	2,200	28.0
160	320	95	29432	2080	5600	1,100	2,000	32.0
170	340	103	29434	2360	6550	1,100	1,900	44.5
180	360	109	29436	2600	7350	1,000	1,800	52.5
190	380	115	29438	2850	8000	950	1,700	60.5
200	400	122	29440	3200	9000	850	1,600	72.0

Series: **294**

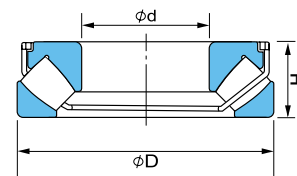

Steel Cage

Principal dimensions			Designation	Basic Load Ratings		Speed ratings		Mass
d	D	H		Dynamic	Static	Reference speed	Limiting speed	
mm				C	C ₀	r/min	kg	
				N				
220	420	122	29444	3350	9650	850	1,500	75.0
240	440	122	29448	3400	10200	850	1,500	80.0
260	480	132	29452	4050	12900	750	1,300	105.0
280	520	145	29456	4900	15300	670	1,200	135.0
300	540	145	29460	5000	16600	670	1,200	140.0
320	580	155	29464	5700	19000	600	1,100	175.0
340	620	170	29468	6700	22400	560	1,000	220.0
360	640	170	29472	6200	21200	560	950	230.0
380	670	175	29476	6800	24000	530	900	260.0
400	710	185	29480	7650	26500	480	850	310.0
420	730	185	29484	7800	27500	480	850	325.0
440	780	206	29488	9000	32000	430	750	410.0
460	800	206	29492	9300	33500	430	750	425.0
480	850	224	29496	9550	39000	340	670	550.0
500	870	224	294/500	9370	40000	340	670	560.0
530	920	236	294/530	10500	44000	320	630	650.0
560	980	250	294/560	12000	51000	300	560	810.0
600	1030	258	294/600	13100	56000	280	530	845.0



Insert Ball Bearing and Ball Bearing Units



Insert Ball Bearing and Ball Bearing Units

Ball Bearing units are simple and economic Bearing arrangements. They offer convenient means to use Rolling Contact Bearings for various applications, without the need of separate Housing to support the Bearing.

Insert Ball Bearing and Ball Bearing Units

Insert Ball Bearing and Pillow Blocks are

- Capable of handling Shaft misalignment (initial errors of alignment) up to a certain degree
- Easy to mount and dismount
- Suitable for low and medium load applications
- Suitable for low and medium speed applications
- Suited for low noise applications
- Generally sealable from both sides; have good protection from the ambient working conditions
- Commonly used in Agricultural Machinery, Conveyor Systems, Food Processing Industry, Packaging Machinery, Construction Equipment and Textile Industry

KG can offer following Ball Bearing Units variants

- Pillow Blocks - UCP, UCPA type
- Square Flange - UCF type
- Flange Cartridge - UCFC type
- Oval Flange - UCFL type
- Take-up Units - UCT type
- AEL types
- Ball Bearing Units with Plastic and Stainless Steel Housings
- Insert Ball Bearings with Stainless Steel



Insert Ball Bearing and Ball Bearing Units

Apart from the list of items presented in the following pages, many other special type of Ball Bearing Units can be developed to meet specific application requirements. Technical information for Bearings not appearing in our production program is available on request.

KG standard suffixes for KG Insert Ball Bearing and Ball Bearing Units

A	Modified internal geometry
G 1 to G6	KG internal grease type codes. For details, please contact KG International FZCO
ND	Special design
NOH	Without oil hole and oil groove on Outer Ring surface
TS	Triple Rubber Seal design
SD	Special location of oil groove and oil holes on Outer Ring surface
WOH	With only oil holes on Outer Ring surface
WOHG	With oil hole and oil groove on Outer Ring surface



Note: Most of the Bearings listed in the following pages of this chapter are available with above suffixes, subject to design or manufacturing constraints.

Single Row Series: UC200

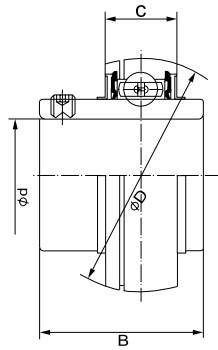

Principal dimensions				Designation	Basic Load Ratings		Mass
Shaft Dia (d)	D	B	C		Dynamic	Static	
					C	C ₀	
					N		
mm							
12	47	31	17	UC201	9880	6200	0.19
15	47	31	17	UC202	9880	6200	0.18
17	47	31	17	UC203	9880	6200	0.17
20	47	31	17	UC204	9880	6200	0.15
25	52	34.1	17	UC205	10780	6980	0.18
30	62	38.1	19	UC206	14970	10040	0.31
35	72	42.9	20	UC207	19750	13670	0.43
40	80	49.2	21	UC208	22710	15940	0.58
45	85	49.2	22	UC209	24360	17710	0.66
50	90	51.6	24	UC210	26980	19840	0.72
55	100	55.6	25	UC211	33370	25110	0.98
60	110	65.1	27	UC212	36740	27970	1.4
65	120	65.1	28	UC213	44010	34180	1.65
70	125	74.6	29	UC214	46790	37590	1.97
75	130	77.8	30	UC215	50850	41260	2.14
80	140	82.6	32	UC216	55040	45090	2.719
85	150	85.7	34	UC217	64010	53280	3.24
90	160	96	36	UC218	73830	60760	3.87

Series: UC200

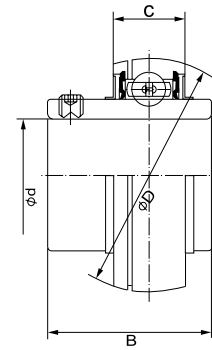

Principal dimensions				Designation	Basic Load Ratings		Mass
Shaft Dia (d)	D	B	C		Dynamic	Static	
					C	C ₀	
					N		
inch							
3/4	1.8504	1.2205	0.6693	UC201-8	9880	6200	0.19
9/16	1.8504	1.2205	0.6693	UC202-9	9880	6200	0.18
5/8	1.8504	1.2205	0.6693	UC202-10	9880	6200	0.18
11/16	1.8504	1.2205	0.6693	UC203-11	9880	6200	0.17
3/4	1.8504	1.2205	0.6693	UC204-12	9880	6200	0.15
13/16	2.00472	1.3425	0.6693	UC205-13	10780	6980	0.18
7/8	2.00472	1.3425	0.6693	UC205-14	10780	6980	0.18
15/16	2.00472	1.3425	0.6693	UC205-15	10780	6980	0.18
1	2.00472	1.3425	0.6693	UC205-16	10780	6980	0.18
1-1/16	2.4409	1.5	0.748	UC206-17	14970	10040	0.31
1-1/8	2.4409	1.5	0.748	UC206-18	14970	10040	0.31
1-3/16	2.4409	1.5	0.748	UC206-19	14970	10040	0.31
1-1/4	2.4409	1.5	0.748	UC206-20	14970	10040	0.31
1-1/4	2.8346	1.689	0.7874	UC207-20	19750	13670	0.43
1-5/16	2.8346	1.689	0.7874	UC207-21	19750	13670	0.43
1-3/8	2.8346	1.689	0.7874	UC207-22	19750	13670	0.43

Series: **UC200**

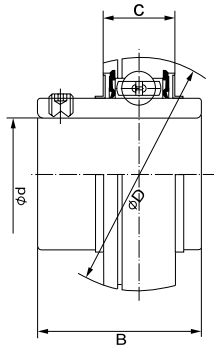

Principal dimensions				Designation	Basic Load Ratings		Mass
Shaft Dia (d)	D	B	C		Dynamic	Static	
					C	C ₀	
					N		
inch							
1-7/16	2.8346	1.689	0.7874	UC207-23	19750	13670	0.43
1-1/12	3.1496	1.937	0.8268	UC208-24	22710	15940	0.58
1-9/16	3.1496	1.937	0.8268	UC208-25	22710	15940	0.58
1-5/8	3.3465	1.937	0.8661	UC209-26	24360	17710	0.66
1-11/16	3.3465	1.937	0.8661	UC209-27	24360	17710	0.66
1-3/4	3.3465	1.937	0.8661	UC209-28	24360	17710	0.66
1-13/16	3.5433	2.0315	0.9449	UC210-29	26980	19840	0.72
1-7/8	3.5433	2.0315	0.9449	UC210-30	26980	19840	0.72
1-15/16	3.5433	2.0315	0.9449	UC210-31	26980	19840	0.72
2	3.5433	2.0315	0.9449	UC210-32	26980	19840	0.72
2	3.937	2.189	0.9843	UC211-32	33370	25110	0.98
2-1/16	3.937	2.189	0.9843	UC211-33	33370	25110	0.98
2-1/8	3.937	2.189	0.9843	UC211-34	33370	25110	0.98
2-3/16	3.937	2.189	0.9843	UC211-35	33370	25110	0.98
2-1/4	4.3307	2.563	1.063	UC212-36	36740	27970	1.4
2-5/16	4.3307	2.563	1.063	UC212-37	36740	27970	1.4
2-3/8	4.3307	2.563	1.063	UC212-38	36740	27970	1.4

Series: **UC200**

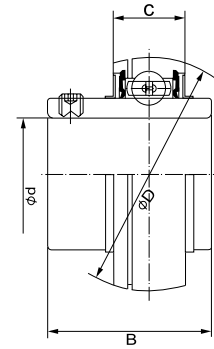

Principal dimensions				Designation	Basic Load Ratings		Mass
Shaft Dia (d)	D	B	C		Dynamic	Static	
					C	C ₀	
					N		
inch							
2-7/16	4.3307	2.563	1.063	UC212-39	36740	27970	1.4
2-1/2	4.3307	2.563	1.1024	UC213-40	44010	34180	1.65
2-9/16	4.3307	2.563	1.1024	UC213-41	44010	34180	1.65
2-5/8	4.9213	2.937	1.1417	UC214-42	46790	37590	1.65
2-11/16	4.9213	2.937	1.1417	UC214-43	46790	37590	1.65
2-3/4	4.9213	2.937	1.1417	UC214-44	46790	37590	1.65
2-13/16	5.1181	3.063	1.1811	UC215-45	50850	41260	2.14
2-7/8	5.1181	3.063	1.1811	UC215-46	50850	41260	2.14
2-15/16	5.1181	3.063	1.1811	UC215-47	50850	41260	2.14
3	5.1181	3.063	1.1811	UC215-48	50850	41260	2.14
3-1/16	5.5118	3.252	1.2598	UC216-49	55040	45090	2.719
3-1/8	5.5118	3.252	1.2598	UC216-50	55040	45090	2.719
3-3/16	5.5118	3.252	1.2598	UC216-51	55040	45090	2.719
3-1/4	5.9055	3.374	1.3386	UC217-52	64010	53280	3.24
3-5/16	5.9055	3.374	1.3386	UC217-53	64010	53280	3.24
3-7/16	5.9055	3.374	1.3386	UC217-55	64010	53280	3.24
3-1/2	6.2992	3.7795	1.4173	UC218-56	73830	60760	3.87

Single Row Series: UC300

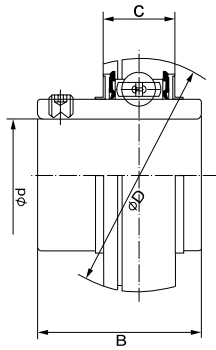

Shaft Dia (d)	Principal dimensions			Designation	Basic Load Ratings		Mass
	D	B	C		Dynamic	Static	
					C	C ₀	
mm				N		kg	
25	62	38	20	UC305	17,220	11930	0.31
30	72	43	23	UC306	20,770	14170	0.51
35	80	48	25	UC307	25,660	17920	0.64
40	90	52	27	UC308	31,350	22380	0.89
45	100	57	30	UC309	40,660	30000	1.2
50	110	61	32	UC310	47,580	35710	1.53
55	120	66	34	UC311	55,050	41910	1.84
60	130	71	36	UC312	62,880	48600	2.32
65	140	75	38	UC313	72,210	56680	2.5
70	150	78	40	UC314	80,100	63480	3.43
75	160	82	42	UC315	87,250	71670	4.26
80	170	86	44	UC316	94,570	80350	5.02
85	180	96	46	UC317	102,050	89520	6.67
90	190	96	48	UC318	110,810	100760	7.56
95	200	103	50	UC319	120,510	103750	8.7

Series: UC300

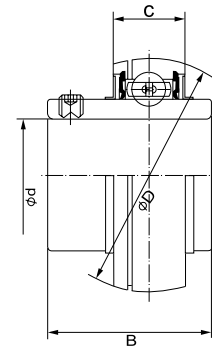

Shaft Dia (d)	Principal dimensions			Designation	Basic Load Ratings		Mass
	D	B	C		Dynamic	Static	
					C	C ₀	
inch				N		kg	
13/16	2.4409	1.4961	0.7874	UC305-13	17220	11930	0.31
7/8	2.4409	1.4961	0.7874	UC305-14	17220	11930	0.31
15/16	2.4409	1.4961	0.7874	UC305-15	17220	11930	0.31
1	2.4409	1.4961	0.7874	UC305-16	17220	11930	0.31
1-1/16	2.8346	1.6929	0.9055	UC306-17	20770	14170	0.51
1-1/8	2.8346	1.6929	0.9055	UC306-18	20770	14170	0.51
1-3/16	2.8346	1.6929	0.9055	UC306-19	20770	14170	0.51
1-1/4	3.1496	1.8898	0.9843	UC307-20	25660	17920	0.64
1-5/16	3.1496	1.8898	0.9843	UC307-21	25660	17920	0.64
1-3/8	3.1496	1.8898	0.9843	UC307-22	25660	17920	0.64
1-7/16	3.1496	1.8898	0.9843	UC307-23	25660	17920	0.64
1-1/2	3.5433	2.0472	1.063	UC308-24	31350	22380	0.89
1-9/16	3.5433	2.0472	1.063	UC308-25	31350	22380	0.89
1-5/8	3.937	2.2441	1.1811	UC309-26	40660	30000	1.2
1-11/16	3.937	2.2441	1.1811	UC309-27	40660	30000	1.2
1-3/4	3.937	2.2441	1.1811	UC309-28	40660	30000	1.2
1-13/16	4.3307	2.4016	1.2598	UC310-29	47580	35710	1.53
1-7/8	4.3307	2.4016	1.2598	UC310-30	47580	35710	1.53
1-15/16	4.3307	2.4016	1.2598	UC310-31	47580	35710	1.53
2	4.7244	2.5984	1.3386	UC311-32	55050	41910	1.84
2-1/16	4.7244	2.5984	1.3386	UC311-33	55050	41910	1.84
2-1/8	4.7244	2.5984	1.3386	UC311-34	55050	41910	1.84
2-3/16	4.7244	2.5984	1.3386	UC311-35	55050	41910	1.84
2-1/4	5.1181	2.7953	1.4173	UC312-36	62880	48600	2.32

Series: **UC300**

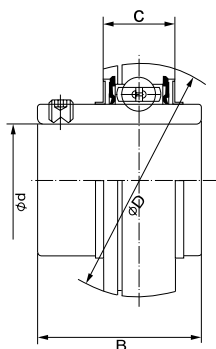

Principal dimensions				Designation	Basic Load Ratings		Mass
Shaft Dia (d)	D	B	C		Dynamic	Static	
					C	C ₀	
					N		
inch							
2-5/16	5.1181	2.7953	1.4173	UC312-37	62880	48600	2.32
2-3/8	5.1181	2.7953	1.4173	UC312-38	62880	48600	2.32
2-7/16	5.1181	2.7953	1.4173	UC312-39	62880	48600	2.32
2-1/2	5.5118	2.9528	1.4961	UC313-40	72210	56680	2.5
2-9/16	5.5118	2.9528	1.4961	UC313-41	72210	56680	2.5
2-5/8	5.9055	3.0708	1.5748	UC314-42	80100	63480	2.5
2-11/16	5.9055	3.0708	1.5748	UC314-43	80100	63480	2.5
2-3/4	5.9055	3.0708	1.5748	UC314-44	80100	63480	2.5
2-13/16	6.2992	3.2283	1.6535	UC315-45	87250	71670	4.26
3-7/8	6.2992	3.2283	1.6535	UC315-46	87250	71670	4.26
2-15/16	6.2992	3.2283	1.6535	UC315-47	87250	71670	4.26
3	6.2992	3.2283	1.6535	UC315-48	87250	71670	4.26
3-1/16	6.6929	3.3858	1.7323	UC316-49	94570	80350	5.02
3-1/8	6.6929	3.3858	1.7323	UC316-50	94570	80350	5.02
3-3/16	6.6929	3.3858	1.7323	UC316-51	94570	80350	5.02
3-1/4	7.0866	3.7795	1.811	UC317-52	102050	89520	6.67
3-5/16	7.0866	3.7795	1.811	UC317-53	102050	89520	6.67
3-7/16	7.0866	3.7795	1.811	UC317-55	102050	89520	6.67
3-7/16	7.4803	3.7795	1.8898	UC318-55	110810	100760	7.56
3-1/2	7.4803	3.7795	1.8898	UC318-56	110810	100760	7.56
3-5/8	7.874	4.0551	1.9685	UC319-58	120510	103750	8.7
3-11/16	7.874	4.0551	1.9685	UC319-59	120510	103750	8.7
3-3/4	7.874	4.0551	1.9685	UC319-60	120510	103750	8.7

Single Row Series: **AEL200**

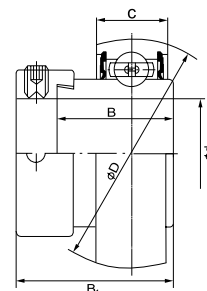

Principal dimensions					Designation	Basic Load Ratings		Mass
Shaft Dia (d)	D	B1	B	C		Dynamic	Static	
						C	C ₀	
						N		
mm								
12	40	28.6	19.1	12	AEL201	7360	4480	0.12
15	40	28.6	19.1	12	AEL202	7360	4480	0.1
17	40	28.6	19.1	12	AEL203	7360	4480	0.09
20	47	31	21.5	14	AEL204	9880	6200	0.16
25	52	31	21.5	15	AEL205	10780	6980	0.2
30	62	35.7	23.8	16	AEL206	14970	10040	0.3
35	72	38.9	25.4	17	AEL207	19750	13670	0.42
40	80	43.7	30.2	18	AEL208	22710	15940	0.6
45	85	43.7	30.2	19	AEL209	24360	17710	0.67
50	90	43.7	30.2	20	AEL210	26980	19840	0.75
55	100	48.4	32.5	21	AEL211	33370	25110	1.26
60	110	53.1	37.2	22	AEL212	36740	27970	1.7

Single Row Series: AEL200

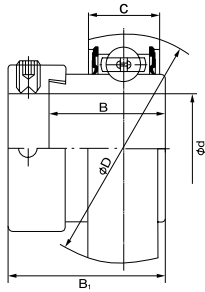

Principal dimensions					Designation	Basic Load Ratings		Mass
Shaft Dia (d)	D	B1	B	C		Dynamic	Static	
						C	C ₀	
						N		
inch								
3/4	1.5748	1.126	0.752	0.4724	AEL201-8	7360	4480	0.12
9/16	1.5748	1.126	0.752	0.4724	AEL209-9	7360	4480	0.1
5/8	1.5748	1.126	0.752	0.4724	AEL209-10	7360	4480	0.1
11/16	1.5748	1.126	0.752	0.4724	AEL203-11	7360	4480	0.1
3/4	1.8504	1.22	0.8465	0.5512	AEL204-12	9980	6200	0.09
13/16	2.0472	1.22	0.8465	0.5906	AEL205-13	10780	6980	0.09
7/8	2.0472	1.22	0.8465	0.5906	AEL205-14	10780	6980	0.09
15/16	2.0472	1.22	0.8465	0.5906	AEL205-15	10780	6980	0.09
1	2.0472	1.22	0.8465	0.5906	AEL205-16	10780	6980	0.09
1-1/16	2.4409	1.406	0.937	0.6299	AEL206-17	14970	10040	0.3
1-1/8	2.4409	1.406	0.937	0.6299	AEL206-18	14970	10040	0.3
1-3/16	2.4409	1.406	0.937	0.6299	AEL206-19	14970	10040	0.3
1-1/4	2.4409	1.406	0.937	0.6299	AEL206-20	14970	10040	0.3
1-1/4	2.8346	1.531	1	0.6693	AEL207-20	19750	13670	0.42
1-5/16	2.8346	1.531	1	0.6693	AEL207-21	19750	13670	0.42
1-3/8	2.8346	1.531	1	0.6693	AEL207-22	19750	13670	0.42
1-7/16	2.8346	1.531	1	0.6693	AEL207-23	19750	13670	0.42

Single Row Series: AEL200

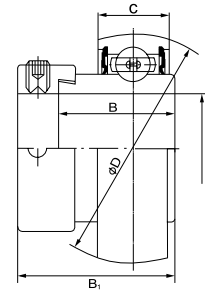

Principal dimensions					Designation	Basic Load Ratings		Mass
Shaft Dia (d)	D	B1	B	C		Dynamic	Static	
						C	C ₀	
						N		
inch								
1-1/2	3.1496	1.721	1.189	0.7087	AEL208-24	22710	15940	0.6
1-9/16	3.1496	1.721	1.189	0.7087	AEL208-25	22710	15940	0.6
1-5/8	3.3465	1.721	1.189	0.748	AEL209-26	24360	17710	0.6
1-11/16	3.3465	1.721	1.189	0.748	AEL209-27	24360	17710	0.6
1-3/4	3.3465	1.721	1.189	0.748	AEL209-28	24360	17710	0.6
1-13/16	3.5433	1.721	1.189	0.7874	AEL210-29	26980	19840	0.75
1-7/8	3.5433	1.721	1.189	0.7874	AEL210-30	26980	19840	0.75
1-15/16	3.5433	1.721	1.189	0.7874	AEL210-31	26980	19840	0.75
2	3.5433	1.721	1.189	0.7874	AEL210-32	26980	19840	0.75
2	3.937	1.906	1.2795	0.8268	AEL211-32	33370	25110	1.26
2-1/16	3.937	1.906	1.2795	0.8268	AEL211-33	33370	25110	1.26
2-1/8	3.937	1.906	1.2795	0.8268	AEL211-34	33370	25110	1.26
2-3/16	3.937	1.906	1.2795	0.8268	AEL211-35	33370	25110	1.26
2-1/4	4.3307	2.091	1.4646	0.8661	AEL212-36	36740	27970	1.7
2-5/16	4.3307	2.091	1.4646	0.8661	AEL212-37	36740	27970	1.7
2-3/8	4.3307	2.091	1.4646	0.8661	AEL212-38	36740	27970	1.7
2-7/16	4.3307	2.091	1.4646	0.8661	AEL212-39	36740	27970	1.7

Series: **UCP200**

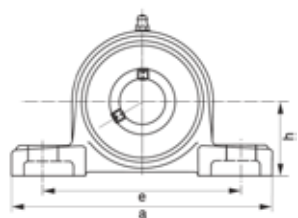

Principal dimensions			Designation	Shaft Dia (d)	Mass
h	a	e			
mm				mm	kg
30.200	127.000	95.000	UCP201	12.000	0.650
30.200	127.000	95.000	UCP202	15.000	0.630
30.200	127.000	95.000	UCP203	17.000	0.620
33.300	127.000	95.000	UCP204	20.000	0.650
36.500	140.000	105.000	UCP205	25.000	0.790
42.900	165.000	121.000	UCP206	30.000	1.300
47.600	167.000	127.000	UCP207	35.000	1.600
49.200	184.000	137.000	UCP208	40.000	2.000
54.000	190.000	146.000	UCP209	45.000	2.300
57.200	206.000	159.000	UCP210	50.000	2.700
63.500	219.000	171.000	UCP211	55.000	3.300
69.800	241.000	184.000	UCP212	60.000	4.700
76.200	265.000	203.000	UCP213	65.000	5.600
79.400	266.000	210.000	UCP214	70.000	7.300
82.600	275.000	217.000	UCP215	75.000	7.900
88.900	292.000	232.000	UCP216	80.000	10.000
95.200	310.000	247.000	UCP217	85.000	12.200
101.600	327.000	262.000	UCP218	90.000	14.700

Series: **UCP200**

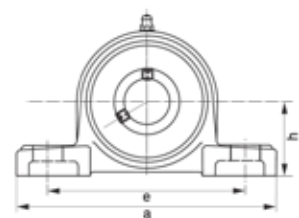

Principal dimensions			Designation	Shaft Dia (d)	Mass
h	a	e			
inch				inch	kg
1-3/8	5	3-3/4	UCP201-8	1/2	0.610
1-3/8	5	3-3/4	UCP202-9	9/16	0.610
1-3/8	5	3-3/4	UCP202-10	5/8	0.610
1-3/8	5	3-3/4	UCP203-11	11/16	0.610
1-5/16	5	3-3/4	UCP204-12	3/4	0.660
1-7/16	5-1/2	4-1/8	UCP205-14	7/8	0.800
1-7/16	5-1/2	4-1/8	UCP205-15	15/16	0.800
1-7/16	5-1/2	4-1/8	UCP205-16	1	0.800
1-11/16	6-1/2	4-3/4	UCP206-17	1-1/16	1.300
1-11/16	6-1/2	4-3/4	UCP206-18	1-1/8	1.300
1-11/16	6-1/2	4-3/4	UCP206-19	1-3/16	1.300
1-7/8	6-9/16	5	UCP207-20	1-1/4	1.600
1-7/8	6-9/16	5	UCP207-21	1-5/16	1.600
1-7/8	6-9/16	5	UCP207-22	1-3/8	1.600
1-7/8	6-9/16	5	UCP207-23	1-7/16	1.600
1-15/16	7-1/4	5-3/8	UCP208-24	1-1/2	2.000

Series: **UCP200**

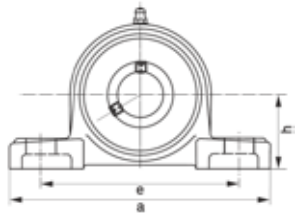

Principal dimensions			Designation	Shaft Dia (d)	Mass
h	a	e			
inch					
1-15/16	7-1/4	5-3/8	UCP208-25	1-9/16	2.000
2-1/8	7-1/2	5-3/4	UCP209-26	1-5/8	2.200
2-1/8	7-1/2	5-3/4	UCP209-27	1-11/16	2.200
2-1/8	7-1/2	5-3/4	UCP209-28	1-3/4	2.200
2-1/4	8-1/8	6-1/4	UCP210-30	1-7/8	2.900
2-1/4	8-1/8	6-1/4	UCP210-31	1-15/16	2.900
2-1/2	8-5/8	6-3/4	UCP211-32	2	3.600
2-1/2	8-5/8	6-3/4	UCP211-34	2-1/8	3.600
2-1/2	8-5/8	6-3/4	UCP211-35	2-3/16	3.600
2-3/4	9-1/2	7-1/4	UCP212-36	2-1/4	4.900
2-3/4	9-1/2	7-1/4	UCP212-38	2-3/8	4.900
2-3/4	9-1/2	7-1/4	UCP212-39	2-3/8	4.900
3	10-7/16	8	UCP213-40	2-1/2	5.900
3-1/8	10-1/2	8-1/4	UCP214-44	2-3/4	6.800
3-1/4	10-11/16	8-1/2	UCP215-48	3	7.400

Series: **UCP300**

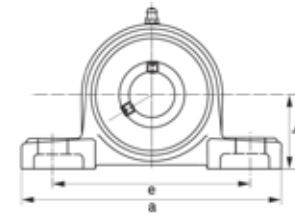

Principal dimensions			Designation	Shaft Dia (d)	Mass
h	a	e			
mm					
45.000	175.000	132.000	UCP305	25.000	1.600
50.000	180.000	140.000	UCP306	30.000	1.900
56.000	210.000	160.000	UCP307	35.000	2.700
60.000	220.000	170.000	UCP308	40.000	3.300
67.000	245.000	190.000	UCP309	45.000	4.500
75.000	275.000	212.000	UCP310	50.000	6.200
80.000	310.000	236.000	UCP311	55.000	7.700
85.000	330.000	250.000	UCP312	60.000	9.300
90.000	340.000	260.000	UCP313	65.000	9.800
95.000	360.000	280.000	UCP314	70.000	11.400
100.000	380.000	290.000	UCP315	75.000	13.600
106.000	400.000	300.000	UCP316	80.000	16.400
112.000	420.000	320.000	UCP317	85.000	18.600
118.000	430.000	330.000	UCP318	90.000	20.900
125.000	470.000	360.000	UCP319	95.000	26.500
140.000	490.000	380.000	UCP320	100.000	34.300



Series: **UCP300**

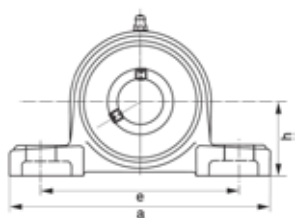

Principal dimensions			Designation	Shaft Dia (d)	Mass
h	a	e			
inch					
1-49/64	6-7/8	5-1/4	UCP305-14	7/8	1.600
1-49/64	6-7/8	5-1/4	UCP305-16	1	1.600
1-31/32	7-1/6	5-1/2	UCP306-18	1-1/8	1.900
2-13/64	8-1/4	6-1/4	UCP307-20	1-1/4	2.700
2-13/64	8-1/4	6-1/4	UCP307-22	1-3/8	2.700
2-23/64	8-11/16	6-3/4	UCP308-24	1-1/2	3.300
2-41/64	9-5/8	7-1/2	UCP309-26	1-5/8	4.500
2-41/64	9-5/8	7-1/2	UCP309-28	1-3/4	4.500
2-61/64	10-13/16	8-3/8	UCP310-30	1-7/8	6.200
3-5/32	12-3/16	9-1/4	UCP311-32	2	7.700
3-5/32	12-3/16	9-1/4	UCP311-34	2-1/8	7.700
3-11/32	13	9-7/8	UCP312-36	2-1/4	9.300
3-11/32	13	9-7/8	UCP312-38	2-3/8	9.300
3-35/64	13-3/8	10-1/4	UCP313-40	2-1/2	9.800
3-47/64	14-3/16	11	UCP314-44	2-3/4	11.400
3-15/16	15	11-3/8	UCP315-48	3	13.600
4-11/64	15-3/4	11-3/4	UCP316-50	3-1/8	16.400
4-13/32	16-9/16	12-5/8	UCP317-52	3-1/4	18.000
4-41/64	16-15/16	13	UCP318-56	3-1/2	20.900
4-59/64	18-1/2	14-1/8	UCP319-60	3-3/4	26.500
5-33/64	19-5/16	15	UCP320-64	4	34.300

Series: **UCF200**

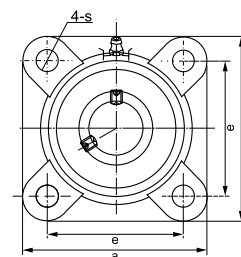

Principal dimensions		Designation	Shaft Dia (d)	Mass
a	e			
mm				
86.000	64.000	UCF201	12.000	0.640
86.000	64.000	UCF202	15.000	0.620
86.000	64.000	UCF203	17.000	0.610
86.000	64.000	UCF204	20.000	0.590
95.000	70.000	UCF205	25.000	0.820
108.000	83.000	UCF206	30.000	1.100
117.000	92.000	UCF207	35.000	1.500
130.000	102.000	UCF208	40.000	2.000
137.000	105.000	UCF209	45.000	2.400
143.000	111.000	UCF210	50.000	2.500
162.000	130.000	UCF211	55.000	3.400
175.000	143.000	UCF212	60.000	4.600
187.000	149.000	UCF213	65.000	5.500
193.000	152.000	UCF214	70.000	6.100
200.000	159.000	UCF215	75.000	6.900
208.000	165.000	UCF216	80.000	7.800
220.000	175.000	UCF217	85.000	9.300
235.000	187.000	UCF218	90.000	11.300



Series: **UCF200**

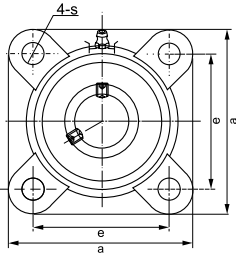

Principal dimensions		Designation	Shaft Dia (d)	Mass
a	e			
inch			inch	kg
3-3/8	2-1/2	UCF201-8	1/2	0.620
3-3/8	2-1/2	UCF202-9	9/16	0.620
3-3/8	2-1/2	UCF202-10	5/8	0.620
3-3/8	2-1/2	UCF203-11	11/16	0.620
3-3/8	2-1/2	UCF204-12	3/4	0.620
3-3/4	2-3/4	UCF205-14	7/8	0.830
3-3/4	2-3/4	UCF205-15	15/16	0.830
3-3/4	2-3/4	UCF205-16	1	0.830
4-1/4	3-1/4	UCF206-17	1-1/16	1.100
4-1/4	3-1/4	UCF206-18	1-1/8	1.100
4-1/4	3-1/4	UCF206-19	1-3/16	1.100
4-5/8	3-5/8	UCF207-20	1-1/4	1.500
4-5/8	3-5/8	UCF207-21	1-5/16	1.500
4-5/8	3-5/8	UCF207-22	1-3/8	1.500
4-5/8	3-5/8	UCF207-23	1-7/16	1.500
5-1/8	4	UCF208-24	1-1/2	1.900
5-1/8	4	UCF208-25	1-9/16	1.900
5-3/8	4-1/8	UCF209-26	1-5/8	2.200

Series: **UCF200**

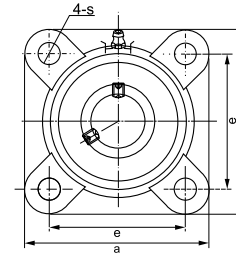

Principal dimensions		Designation	Shaft Dia (d)	Mass
a	e			
inch			inch	kg
5-3/8	4-1/8	UCF209-27	1-11/16	2.200
5-3/8	4-1/8	UCF209-28	1-3/4	2.200
5-5/8	4-3/8	UCF210-30	1-7/8	2.500
5-5/8	4-3/8	UCF210-31	1-15/16	2.500
6-3/8	5-1/8	UCF211-32	2	3.400
6-3/8	5-1/8	UCF211-34	2-1/8	3.400
6-3/8	5-1/8	UCF211-35	2-3/16	3.400
6-7/8	5-5/8	UCF212-36	2-1/4	4.200
6-7/8	5-5/8	UCF212-38	2-3/8	4.200
6-7/8	5-5/8	UCF212-39	2-7/16	4.200
7-3/8	5-7/8	UCF213-40	2-1/2	5.200
7-5/8	6	UCF214-44	2-3/4	5.900
7-7/8	6-1/4	UCF215-48	3	6.400
8-3/16	6-1/2	UCF216-50	3-1/8	7.300
8-11/16	6-7/8	UCF217-52	3-1/4	8.900
9-1/4	7-3/8	UCF218-56	3-1/2	11.400



Series: **UCF300**

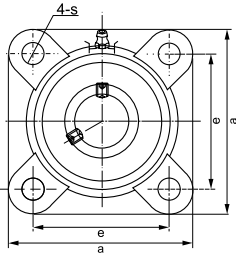

Principal dimensions		Designation	Shaft Dia (d)	Mass
a	e			
mm			mm	kg
110.000	80.000	UCF305	25.000	1.200
125.000	95.000	UCF306	30.000	1.700
135.000	100.000	UCF307	35.000	2.100
150.000	112.000	UCF308	40.000	2.900
160.000	125.000	UCF309	45.000	3.600
175.000	132.000	UCF310	50.000	4.700
185.000	140.000	UCF311	55.000	5.700
195.000	150.000	UCF312	60.000	6.800
208.000	166.000	UCF313	65.000	7.800
226.000	178.000	UCF314	70.000	9.600
236.000	184.000	UCF315	75.000	11.700
250.000	196.000	UCF316	80.000	13.700
260.000	204.000	UCF317	85.000	15.200
280.000	216.000	UCF318	90.000	18.800
290.000	228.000	UCF319	95.000	20.700
310.000	242.000	UCF320	100.000	24.800

Series: **UCF300**

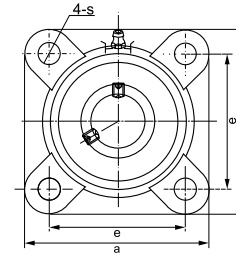

Principal dimensions		Designation	Shaft Dia (d)	Mass
a	e			
inch			inch	kg
4-5/16	3-5/32	UCF305-14	7/8	1.200
4-5/16	3-5/32	UCF305-16	1	1.200
4-15/16	3-47/64	UCF306-18	1-1/8	1.560
5-5/16	3-15/16	UCF307-20	1-1/4	2.100
5-5/16	3-15/16	UCF307-22	1-3/8	2.100
5-7/8	4-13/32	UCF308-24	1-1/2	2.900
6-5/16	4-59/64	UCF309-26	1-5/8	3.600
6-5/16	4-59/64	UCF309-28	1-3/4	3.600
6-7/8	5-13/64	UCF310-30	1-7/8	4.700
7-5/16	5-33/64	UCF311-32	2	5.700
7-5/16	5-33/64	UCF311-34	2-1/8	5.700
7-11/16	5-29/32	UCF312-36	2-1/4	6.800
7-11/16	5-29/32	UCF312-38	2-3/8	6.800
8-3/16	6-17/32	UCF313-40	2-1/2	7.800
8-7/8	7-1/64	UCF314-44	2-3/4	9.600
9-5/16	7-1/4	UCF315-48	3	11.700
9-11/16	7-23/32	UCF316-50	3-1/8	13.700
10-1/4	8-1/32	UCF317-52	3-1/4	15.200
11	8-1/2	UCF318-56	3-1/2	18.800
11-7/16	8-31/32	UCF319-60	3-3/4	20.700
12-3/16	9-17/32	UCF320-64	4	24.800

Series: **UCPA200**

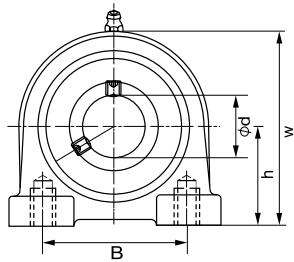

b: Inner Ring Width of Bearing
W= Width of Housing Base

Principal dimensions					Designation	Mass
Shaft Dia (d)	h	W	w	b		
mm						kg
12.000	30.200	40.000	62.000	31.000	UCPA201	0.600
15.000	30.200	40.000	62.000	31.000	UCPA202	0.590
17.000	30.200	40.000	62.000	31.000	UCPA203	0.580
20.000	30.200	40.000	62.000	31.000	UCPA204	0.560
25.000	36.500	38.000	72.000	34.100	UCPA205	0.830
30.000	42.900	50.000	84.000	38.100	UCPA206	1.120
35.000	47.600	55.000	95.000	42.900	UCPA207	1.480
40.000	49.200	58.000	100.000	49.200	UCPA208	1.890
45.000	54.200	60.000	108.000	49.200	UCPA209	1.980
50.000	57.200	64.000	116.000	51.600	UCPA210	2.160
55.000	63.500	66.000	125.000	55.600	UCPA211	3.260
60.000	69.900	68.000	138.000	65.100	UCPA212	4.190

Series: **UCPA200**

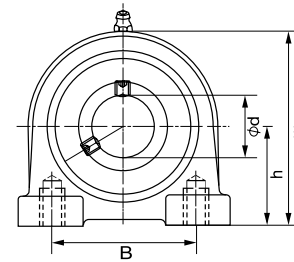

b: Inner Ring Width of Bearing
W= Width of Housing Base

Principal dimensions					Designation	Mass
Shaft Dia (d)	h	W	w	b		
inch						kg
3/4	1-3/16	1-9/16	2-7/16	1.220	UCPA201-8	0.590
9/16	1-3/16	1-9/16	2-7/16	1.220	UCPA202-9	0.590
5/8	1-3/16	1-9/16	2-7/16	1.220	UCPA202-10	0.590
11/16	1-3/16	1-9/16	2-7/16	1.220	UCPA203-11	0.570
3/4	1-3/16	1-9/16	2-7/16	1.220	UCPA204-12	0.560
13/16	1-7/16	1-1/2	2-53/64	1.342	UCPA205-13	0.870
7/8	1-7/16	1-1/2	2-53/64	1.342	UCPA205-14	0.860
15/16	1-7/16	1-1/2	2-53/64	1.342	UCPA205-15	0.840
1	1-7/16	1-1/2	2-53/64	1.342	UCPA205-16	0.830
1-1/16	1-1/16	1-31/32	3-5/16	1.500	UCPA206-17	1.150
1-1/8	1-1/16	1-31/32	3-5/16	1.500	UCPA206-18	1.140
1-3/16	1-1/16	1-31/32	3-5/16	1.500	UCPA206-19	1.120
1-1/4	1-1/16	1-31/32	3-5/16	1.500	UCPA206-20	1.110
1-1/4	1-7/8	2-11/64	3-47/64	1.689	UCPA207-20	1.540
1-5/16	1-7/8	2-11/64	3-47/64	1.689	UCPA207-21	1.510
1-3/8	1-7/8	2-11/64	3-47/64	1.689	UCPA207-22	1.480
1-7/16	1-7/8	2-11/64	3-47/64	1.689	UCPA207-23	1.450



Series: **UCPA200**

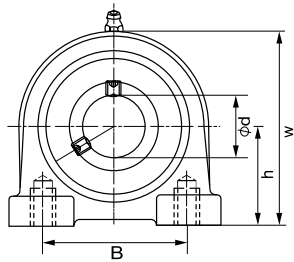

b: Inner Ring Width of Bearing
W= Width of Housing Base

Principal dimensions					Designation	Mass
Shaft Dia (d)	h	W	w	b		
inch						kg
1-1/2	1-15/16	2-9/32	3-15/16	1.937	UCPA208-24	1.930
1-9/16	1-5/16	2-9/32	3-15/16	1.937	UCPA208-25	1.900
1-5/8	2-9/64	2-23/64	4-1/4	1.937	UCPA209-26	2.080
1-11/16	2-9/64	2-23/64	4-1/4	1.937	UCPA209-27	2.040
1-3/4	2-9/64	2-23/64	4-1/4	1.937	UCPA209-28	2.000
1-3/16	2-1/4	2-33/64	4-9/16	2.031	UCPA210-29	2.280
1-7/8	2-1/4	2-33/64	4-9/16	2.031	UCPA210-30	2.230
1-15/16	2-1/4	2-33/64	4-9/16	2.031	UCPA210-31	2.180
2	2-1/4	2-33/64	4-9/16	2.031	UCPA210-32	2.140
2	2-1/2	2-19/32	4-59/64	2.189	UCPA211-32	3.410
2-1/16	2-1/2	2-19/32	4-59/64	2.189	UCPA211-33	3.350
2-1/8	2-1/2	2-19/32	4-59/64	2.189	UCPA211-34	3.300
2-3/16	2-1/2	2-19/32	4-59/64	2.189	UCPA211-35	3.240
2-1/4	2-3/4	2-43/64	5-7/16	2.563	UCPA212-36	4.320
2-5/16	2-3/4	2-43/64	5-7/16	2.563	UCPA212-37	4.240
2-3/8	2-3/4	2-43/64	5-7/16	2.563	UCPA212-38	4.170
2-7/16	2-3/4	2-43/64	5-7/16	2.563	UCPA212-39	4.100

Series: **UCFC200**

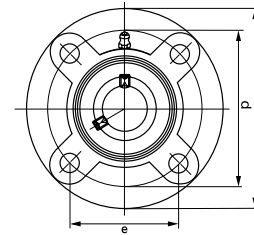

d: Shaft Diameter
B: Width of Inner Ring

Principal dimensions					Designation	Mass
Shaft Dia (d)	a	p	e	B		
mm						kg
12.000	100.000	78.000	55.100	31.000	UCFC201	0.730
15.000	100.000	78.000	55.100	31.000	UCFC202	0.720
17.000	100.000	78.000	55.100	31.000	UCFC203	0.710
20.000	100.000	78.000	55.100	31.000	UCFC204	0.690
25.000	115.000	90.000	63.600	34.100	UCFC205	1.000
30.000	125.000	100.000	70.700	38.100	UCFC206	1.300
35.000	135.000	110.000	77.800	42.900	UCFC207	1.810
40.000	145.000	120.000	84.800	49.200	UCFC208	2.140
45.000	160.000	132.000	93.300	49.200	UCFC209	2.680
50.000	165.000	138.000	97.600	51.600	UCFC210	2.900
55.000	185.000	150.000	106.100	55.600	UCFC211	4.010
60.000	195.000	160.000	113.100	65.100	UCFC212	4.940
65.000	205.000	170.000	120.200	65.100	UCFC213	5.650
70.000	215.000	177.000	125.100	74.600	UCFC214	6.950
75.000	220.000	184.000	130.100	77.800	UCFC215	7.560
80.000	240.000	200.000	141.400	82.600	UCFC216	9.150
85.000	250.000	208.000	147.100	85.700	UCFC217	10.810
90.000	265.000	220.000	155.500	96.000	UCFC218	12.960

Series: **UCFL200**

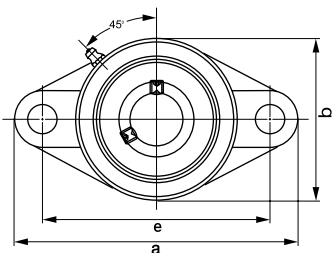

Principal dimensions			Designation	Shaft Dia (d)	Mass
a	e	b			
mm					
113.000	90.000	60.000	UCFL201	12.000	0.500
113.000	90.000	60.000	UCFL202	15.000	0.480
113.000	90.000	60.000	UCFL203	17.000	0.470
113.000	90.000	60.000	UCFL204	20.000	0.450
130.000	99.000	68.000	UCFL205	25.000	0.630
148.000	117.000	80.000	UCFL206	30.000	0.960
161.000	130.000	90.000	UCFL207	35.000	1.200
175.000	144.000	100.000	UCFL208	40.000	1.600
188.000	148.000	108.000	UCFL209	45.000	1.900
197.000	157.000	115.000	UCFL210	50.000	2.200
224.000	184.000	130.000	UCFL211	55.000	3.200
250.000	202.000	140.000	UCFL212	60.000	4.100
258.000	210.000	155.000	UCFL213	65.000	5.100
265.000	216.000	160.000	UCFL214	70.000	6.000
275.000	225.000	165.000	UCFL215	75.000	6.500
290.000	233.000	180.000	UCFL216	80.000	8.000
305.000	248.000	190.000	UCFL217	85.000	9.500
320.000	265.000	205.000	UCFL218	90.000	11.900

Series: **UCFL200**

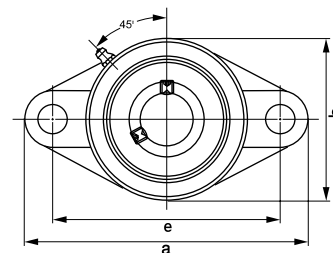

Principal dimensions			Designation	Shaft Dia (d)	Mass
a	e	b			
inch					
4-7/16	3-35/64	2-3/8	UCFL201-8	1/2	0.480
4-7/16	3-35/64	2-3/8	UCFL202-9	9/16	0.480
4-7/16	3-35/64	2-3/8	UCFL202-10	5/8	0.480
4-7/16	3-35/64	2-3/8	UCFL203-11	11/16	0.480
4-7/16	3-35/64	2-3/8	UCFL204-12	3/4	0.480
5-1/8	3-57/64	2-11/16	UCFL205-14	7/8	0.640
5-1/8	3-57/64	2-11/16	UCFL205-15	15/16	0.640
5-1/8	3-57/64	2-11/16	UCFL205-16	1	0.640
5-13/16	4-39/64	3-1/8	UCFL206-17	1-1/16	0.930
5-13/16	4-39/64	3-1/8	UCFL206-18	1-1/8	0.930
5-13/16	4-39/64	3-1/8	UCFL206-19	1-3/16	0.930
6-5/16	5-1/8	3-9/16	UCFL207-20	1-1/4	1.200
6-5/16	5-1/8	3-9/16	UCFL207-21	1-5/16	1.200
6-5/16	5-1/8	3-9/16	UCFL207-22	1-3/8	1.200
6-5/16	5-1/8	3-9/16	UCFL207-23	1-7/16	1.200
6-7/8	5-43/64	3-15/16	UCFL208-24	1-1/2	1.600

Series: **UCFL200**

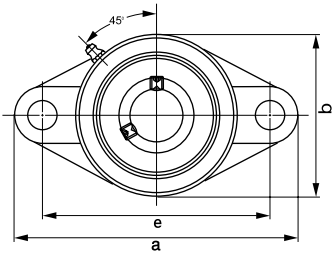

Principal dimensions			Designation	Shaft Dia (d)	Mass
a	e	b			
inch				inch	kg
6-7/8	5-43/64	3-15/16	UCFL208-25	1-9/16	1.600
7-3/8	5-53/64	4-1/4	UCFL209-26	1-5/8	1.900
7-3/8	5-53/64	4-1/4	UCFL209-27	1-11/16	1.900
7-3/8	5-53/64	4-1/4	UCFL209-28	1-3/4	1.900
7-3/4	6-3/16	4-1/2	UCFL210-30	1-7/8	2.200
7-3/4	6-3/16	4-1/2	UCFL210-31	1-15/16	2.200
8-13/16	7-1/4	5-1/8	UCFL211-32	2	3.300
8-13/16	7-1/4	5-1/8	UCFL211-34	2-1/8	3.300
8-13/16	7-1/4	5-1/8	UCFL211-35	2-3/16	3.300
9-13/16	7-61/64	5-1/2	UCFL212-36	2-1/4	4.200
9-13/16	7-61/64	5-1/2	UCFL212-38	2-3/8	4.200
9-13/16	7-61/64	5-1/2	UCFL212-39	2-7/16	4.200
10-13/16	8-17/64	6-1/8	UCFL213-40	2-1/2	5.100
10-7/16	8-1/2	6-5/16	UCFL214-44	2-3/4	5.700
10-13/16	8-55/64	6-1/2	UCFL215-48	3	6.400
11-7/16	9-11/64	7-1/16	UCFL216-50	3-1/8	7.800

Series: **UCFL300**

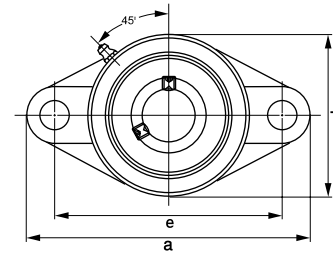

Principal dimensions			Designation	Shaft Dia (d)	Mass
a	e	b			
mm				mm	kg
150.000	113.000	80.000	UCFL305	25.000	1.100
180.000	134.000	90.000	UCFL306	30.000	1.500
185.000	141.000	100.000	UCFL307	35.000	1.800
200.000	158.000	112.000	UCFL308	40.000	2.400
230.000	177.000	125.000	UCFL309	45.000	3.400
240.000	187.000	140.000	UCFL310	50.000	4.300
250.000	198.000	150.000	UCFL311	55.000	5.100
270.000	212.000	160.000	UCFL312	60.000	6.200
295.000	240.000	175.000	UCFL313	65.000	7.400
315.000	250.000	185.000	UCFL314	70.000	9.000
320.000	260.000	195.000	UCFL315	75.000	10.000
355.000	285.000	210.000	UCFL316	80.000	12.600
370.000	300.000	220.000	UCFL317	85.000	14.500
385.000	315.000	235.000	UCFL318	90.000	17.100
405.000	330.000	250.000	UCFL319	95.000	21.800
440.000	360.000	270.000	UCFL320	100.000	26.500



Series: **UCFL300**

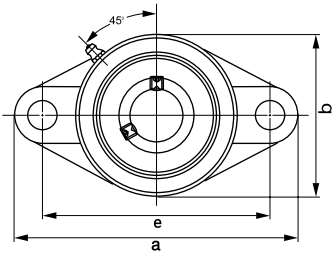

Series: **UCFC200**

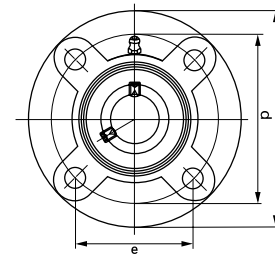

d: Shaft Diameter
B: Width of Inner Ring

Principal dimensions			Designation	Shaft Dia (d)	Mass
a	e	b			
inch					
5-7/8	4-29/64	3-1/8	UCFL305-14	7/8	1.100
5-7/8	4-29/64	3-1/8	UCFL305-16	1	1.100
7-1/16	5-9/32	3-9/16	UCFL306-18	1-1/8	1.500
7-5/16	5-35/64	3-15/16	UCFL307-20	1-1/4	1.800
7-5/16	5-35/64	3-15/16	UCFL307-22	1-3/8	1.800
7-7/8	6-7/32	4-7/16	UCFL308-24	1-1/2	2.400
9-1/16	6-31/32	4-15/16	UCFL309-26	1-5/8	3.400
9-1/16	6-31/32	4-15/16	UCFL309-28	1-3/4	3.400
9-7/16	7-23/64	5-1/2	UCFL310-30	1-7/8	4.300
9-13/16	7-51/64	5-7/8	UCFL311-32	2	5.100
9-13/16	7-51/64	5-7/8	UCFL311-34	2-1/8	5.100
10-5/8	8-11/32	6-5/16	UCFL312-36	2-1/4	6.200
10-5/8	8-11/32	6-5/16	UCFL312-38	2-3/8	6.200
11-5/8	9-29/64	6-7/8	UCFL313-40	2-1/2	7.400
12-3/8	9-27/32	7-5/16	UCFL314-44	2-3/4	9.000
12-5/8	10-15/64	7-11/16	UCFL315-48	3	10.000
14	11-3/16	8-1/4	UCFL316-50	3-1/8	12.600
14-9/16	11-13/16	8-11/16	UCFL317-52	3-1/4	14.500
15-3/16	12-13/32	9-1/4	UCFL318-56	3-1/2	17.100
15-15/16	12-63/64	9-13/16	UCFL319-60	3-3/4	21.800
17-5/16	14-11/64	10-5/8	UCFL320-64	4	26.500

Principal dimensions					Designation	Mass
Shaft Dia (d)	a	p	e	B		
inch						
3-4	3-15/16	3-5/64	2-11/64	1.220	UCFC201-8	0.720
9/16	3-15/16	3-5/64	3-5/64	1.220	UCFC202-9	0.720
5/8	3-15/16	3-5/64	2-11/64	1.220	UCFC202-10	0.720
11/16	3-15/16	3-5/64	2-11/64	1.220	UCFC203-11	0.700
3/4	3-15/16	3-5/64	2-11/64	1.220	UCFC204-12	0.690
13/16	4-17/32	3-35/64	2-1/2	1.342	UCFC205-13	1.040
7/8	4-17/32	3-35/64	2-1/2	1.342	UCFC205-14	1.030
15/16	4-17/32	3-35/64	2-1/2	1.342	UCFC205-15	1.010
1	4-17/32	3-35/64	2-1/2	1.342	UCFC205-16	1.000
1-1/16	4-59/64	3-15/16	2-25/32	1.500	UCFC206-17	1.310
1-1/8	4-59/64	3-15/16	2-25/32	1.500	UCFC206-18	1.320
1-3/16	4-59/64	3-15/16	2-25/32	1.500	UCFC206-19	1.300
1-1/4	4-59/64	3-15/16	2-25/32	1.500	UCFC206-20	1.290
1-1/4	5-5/16	4-21/64	3-1/16	1.689	UCFC207-20	1.870
1-5/16	5-5/16	4-21/64	3-1/16	1.689	UCFC207-21	1.840
1-3/8	5-5/16	4-21/64	3-1/16	1.689	UCFC207-22	1.810
1-7/16	5-5/16	4-21/64	3-1/16	1.689	UCFC207-23	1.780
1-1/2	5-45/64	4-23/32	3-11/32	1.937	UCFC208-24	2.180
1-9/16	5-45/64	4-23/32	3-11/32	1.937	UCFC208-25	2.150
1-5/8	6-19/64	5-13/64	3-43/64	1.937	UCFC209-26	2.780
1-1/16	6-19/64	5-13/64	3-43/64	1.937	UCFC209-27	2.740
1-3/4	6-19/64	5-13/64	3-43/64	1.937	UCFC209-28	2.700
1-13/16	6-1/2	5-7/16	3-27/32	2.031	UCFC210-29	3.020
1-7/8	6-1/2	5-7/16	3-27/32	2.031	UCFC210-30	2.970
1-15/16	6-1/2	5-7/16	3-27/32	2.031	UCFC210-31	2.920

Series: **UCFC200**

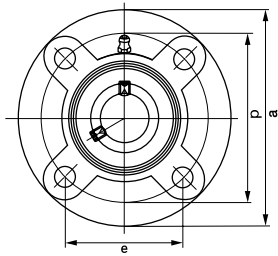

d: Shaft Diameter
B: Width of Inner Ring

Principal dimensions					Designation	Mass
Shaft Dia (d)	a	p	e	B		
inch						
2	6-1/2	5-7/16	3-27/32	2.031	UCFC210-32	2.880
2	7-9/32	5-29/32	4-3/16	2.189	UCFC211-32	4.160
2-1/16	7-9/32	5-29/32	4-3/16	2.189	UCFC211-33	4.100
2-1/8	7-9/32	5-29/32	4-3/16	2.189	UCFC211-34	4.050
2-3/16	7-9/32	5-29/32	4-3/16	2.189	UCFC211-35	3.990
2-1/4	7-11/16	6-19/64	4-29/64	2.563	UCFC212-36	5.070
2-5/16	7-11/16	6-19/64	4-29/64	2.563	UCFC212-37	4.990
2-3/8	7-11/16	6-19/64	4-29/64	2.563	UCFC212-38	4.920
2-7/16	7-11/16	6-19/64	4-29/64	2.563	UCFC212-39	4.850
2-1/2	8-5/64	6-11/16	4-47/64	2.563	UCFC213-40	5.740
2-9/16	8-5/64	6-11/16	4-47/64	2.563	UCFC213-41	5.650
2-5/8	8-15/32	6-31/32	4-59/64	2.937	UCFC214-42	7.160
2-11/16	8-15/32	6-31/32	4-59/64	2.937	UCFC214-43	7.060
2-3/4	8-15/32	6-31/32	4-59/64	2.937	UCFC214-44	6.960
2-13/16	8-21/32	7-1/4	5-1/8	3.063	UCFC215-45	7.810
2-7/8	8-21/32	7-1/4	5-1/8	3.063	UCFC215-46	7.700
2-15/16	8-21/32	7-1/4	5-1/8	3.063	UCFC215-47	7.590
3	8-21/32	7-1/4	5-1/8	3.063	UCFC215-48	7.470
3-1/16	9-29/64	7-7/8	5-9/16	3.252	UCFC216-49	9.280
3-1/8	9-29/64	7-7/8	5-9/16	3.252	UCFC216-50	9.200
3-3/6	9-29/64	7-7/8	5-9/16	3.252	UCFC216-51	9.070
3-1/4	9-27/32	8-3/16	5-51/64	3.374	UCFC217-52	11.030
3-5/16	9-27/32	8-3/16	5-51/64	3.374	UCFC217-53	10.890
3-7/16	9-27/32	8-3/16	5-51/64	3.374	UCFC217-54	10.600
3-1/2	10-7/16	8-21/32	6-1/8	3.779	UCFC218-56	13.070

Series: **UCT200**

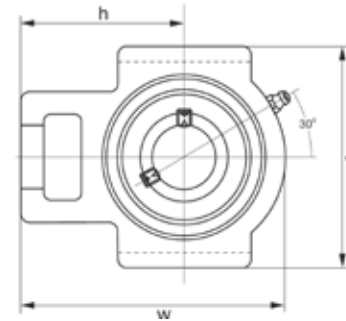

Principal dimensions			Designation	Shaft Dia (d)	Mass
a	w	h			
mm				mm	kg
89.000	94.000	61.000	UCT201	12.000	0.790
89.000	94.000	61.000	UCT202	15.000	0.770
89.000	94.000	61.000	UCT203	17.000	0.760
89.000	94.000	61.000	UCT204	20.000	0.740
89.000	97.000	62.000	UCT205	25.000	0.820
102.000	113.000	70.000	UCT206	30.000	1.300
102.000	129.000	78.000	UCT207	35.000	1.600
114.000	144.000	88.000	UCT208	40.000	2.400
117.000	144.000	87.000	UCT209	45.000	2.400
117.000	149.000	90.000	UCT210	50.000	2.500
146.000	171.000	106.000	UCT211	55.000	4.000
146.000	194.000	119.000	UCT212	60.000	5.100
167.000	224.000	137.000	UCT213	65.000	7.000
167.000	224.000	137.000	UCT214	70.000	7.100
167.000	232.000	140.000	UCT215	75.000	7.500
184.000	235.000	140.000	UCT216	80.000	8.500
198.000	260.000	162.000	UCT217	85.000	11.200



Series: **UCT200**

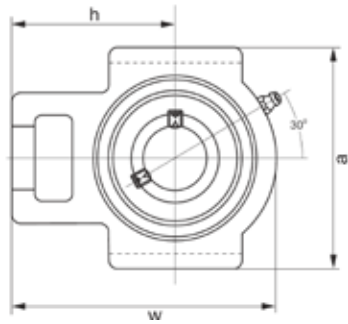

Principal dimensions			Designation	Shaft Dia (d)	Mass
a	w	h			
inch				inch	kg
3-1/2	3-11/16	2-13/32	UCT203-11	11/16	0.790
3-1/2	3-11/16	2-13/32	UCT204-12	3/4	0.790
3-1/2	3-11/16	2-7/16	UCT205-14	7/8	0.840
3-1/2	3-11/16	2-7/16	UCT205-15	15/16	0.840
3-1/2	3-11/16	2-7/16	UCT205-16	1	0.840
4	4-7/16	2-3/4	UCT206-17	1-1/16	1.300
4	4-7/16	2-3/4	UCT206-18	1-1/8	1.300
4	4-7/16	2-3/4	UCT206-19	1-3/16	1.300
4	5-1/16	3-1/16	UCT207-20	1-1/4	1.600
4	5-1/16	3-1/16	UCT207-21	1-5/16	1.600
4	5-1/16	3-1/16	UCT207-22	1-3/8	1.600
4	5-1/16	3-1/16	UCT207-23	1-7/16	1.600
4-1/2	5-11/16	3-15/32	UCT208-24	1-1/2	2.500
4-1/2	5-11/16	3-15/32	UCT208-25	1-9/16	2.500
4-5/8	5-11/16	3-7/16	UCT209-26	1-5/8	2.400

Series: **UCT200**

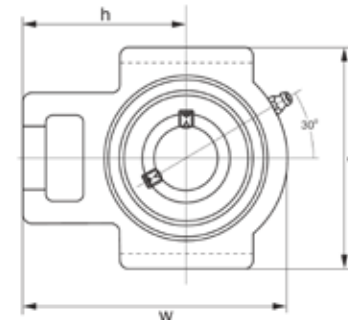

Principal dimensions			Designation	Shaft Dia (d)	Mass
a	w	h			
inch				inch	kg
4-5/8	5-11/16	3-7/16	UCT209-27	1-11/16	2.400
4-5/8	5-11/16	3-7/16	UCT209-28	1-3/4	2.400
4-5/8	5-7/8	3-17/32	UCT210-30	1-7/8	2.600
4-5/8	5-7/8	3-17/32	UCT210-31	1-15/16	2.600
5-3/4	6-3/4	4-3/16	UCT211-32	2	4.000
5-3/4	6-3/4	4-3/16	UCT211-34	2-1/8	4.000
5-3/4	6-3/4	4-3/16	UCT211-35	2-3/16	4.000
5-3/4	7-5/8	4-11/16	UCT212-36	2-1/4	4.900
5-3/4	7-5/8	4-11/16	UCT212-38	2-3/8	4.900
5-3/4	7-5/8	4-11/16	UCT212-39	2-7/16	4.900
6-9/16	8-13/16	5-13/32	UCT213-40	2-1/2	6.900
6-9/16	8-13/16	5-13/32	UCT214-44	2-3/4	7.000
6-9/16	9-1/8	5-1/2	UCT215-48	3	7.300
7-1/4	9-1/4	5-1/2	UCT216-50	3-1/8	8.200
7-13/16	10-1/4	6-3/8	UCT217-52	3-1/4	11.000



Series: **UCT300**

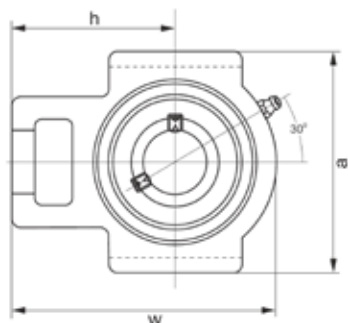

Principal dimensions			Designation	Shaft Dia (d)	Mass
a	w	h			
mm					
89.000	122.000	76.000	UCT305	25.000	1.400
100.000	137.000	85.000	UCT306	30.000	1.800
111.000	150.000	94.000	UCT307	35.000	2.400
124.000	162.000	100.000	UCT308	40.000	3.000
138.000	178.000	110.000	UCT309	45.000	4.100
151.000	191.000	117.000	UCT310	50.000	5.200
163.000	207.000	127.000	UCT311	55.000	6.400
178.000	220.000	135.000	UCT312	60.000	7.600
190.000	238.000	146.000	UCT313	65.000	9.200
202.000	252.000	155.000	UCT314	70.000	11.200
216.000	262.000	160.000	UCT315	75.000	13.000
230.000	282.000	174.000	UCT316	80.000	15.600
240.000	298.000	183.000	UCT317	85.000	19.300
255.000	312.000	192.000	UCT318	90.000	21.200
270.000	322.000	197.000	UCT319	95.000	24.400
290.000	345.000	210.000	UCT320	100.000	30.600

Series: **UCT300**

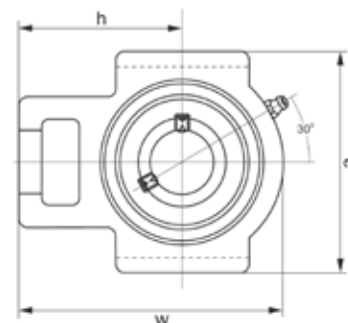

Principal dimensions			Designation	Shaft Dia (d)	Mass
a	w	h			
inch					
3-1/2	4-13/16	3	UCT305-14	7/8	1.400
3-1/2	4-13/16	3	UCT305-16	1	1.400
3-15/16	5-3/8	3-11/32	UCT306-18	1-1/8	1.800
4-3/8	5-7/8	3-11/16	UCT307-20	1-1/4	2.400
4-3/8	5-7/8	3-11/16	UCT307-22	1-3/8	2.400
4-7/8	6-3/8	3-15/16	UCT308-24	1-1/2	3.000
5-7/16	7	4-11/32	UCT309-26	1-5/8	4.100
5-7/16	7	4-11/32	UCT309-28	1-3/4	4.100
5-15/16	7-1/2	4-19/32	UCT310-30	1-7/8	5.200
6-7/16	8-1/8	5	UCT311-32	2	6.400
6-7/16	8-1/8	5	UCT311-34	2-1/8	6.400
7	8-11/16	5-5/16	UCT312-36	2-1/4	7.600
7	8-11/16	5-5/16	UCT312-38	2-3/8	7.600
7-1/2	9-3/8	5-3/4	UCT313-40	2-1/2	9.200
7-15/16	9-15/16	6-3/32	UCT314-44	2-3/4	11.200
8-1/2	10-5/16	6-5/16	UCT315-48	3	13.000
9-1/16	11-1/8	6-27/32	UCT316-50	3-1/8	15.600
9-7/16	11-3/4	7-7/32	UCT317-52	3-1/4	19.300
10-1/16	12-5/16	7-9/16	UCT318-56	3-1/2	21.200
10-5/8	12-11/16	7-3/4	UCT319-60	3-3/4	24.400
11-7/16	13-9/16	8-9/32	UCT320-64	4	30.600

Series: **UCHA200**

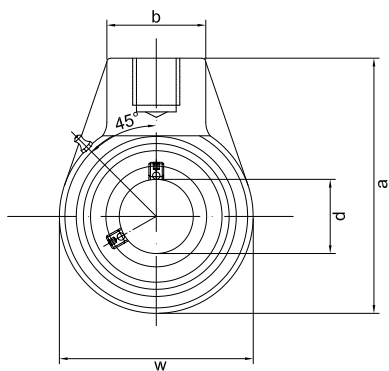

Principal dimensions			Designation	Shaft Dia (d)	Mass
a	w	b			
mm				mm	kg
96	64	40	UCHA201	12	0.73
96	64	40	UCHA203	17	0.71
96	64	40	UCHA204	20	0.69
103	78	40	UCHA205	25	0.83
103	78	40	UCHA206	30	0.83
116	92	40	UCHA207	35	1.16
121	96	40	UCHA208	40	1.32
136	108	48	UCHA209	45	1.92
142	118	48	UCHA210	50	1.9
150	126	60	UCHA211	55	2.61
173	142	60	UCHA212	60	3.54
200	166	70	UCHA213	65	5.8
200	166	70	UCHA214	70	5.67
200	166	70	UCHA215	75	5.58

Series: **UCPH200**

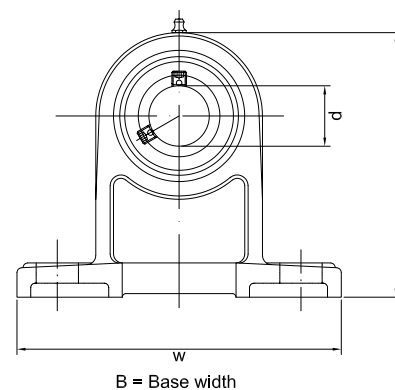

Principal dimensions			Designation	Shaft Dia (d)	Mass
a	w	B			
mm				mm	kg
101	127	40	UCPH201	12	0.81
101	127	40	UCPH202	15	0.8
101	127	40	UCPH203	17	0.79
101	127	40	UCPH204	20	0.77
114	140	50	UCPH205	25	1.01
130	161	50	UCPH206	30	1.47
140	166	60	UCPH207	35	1.91
150	178	70	UCPH208	40	2.52
158	189	70	UCPH209	45	2.72
165	205	70	UCPH210	50	3.1
181	219	75	UCPH211	55	5.51
197	241	85	UCPH212	60	6.34
212	265	95	UCPH213	65	7.45
225	266	105	UCPH214	70	8.25
238	275	115	UCPH215	75	9.61
253	292	125	UCPH216	80	10.8

Series: **UKFL200**

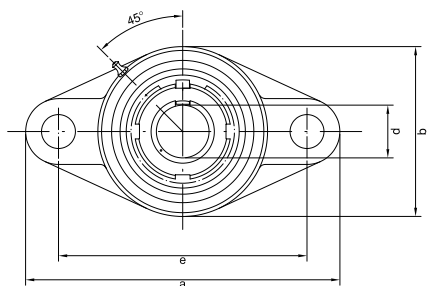

Principal dimensions			Designation	Shaft Dia (d)	Mass
a	e	b			
mm				mm	kg
130	99	68	UKFL205	20	0.63
148	117	80	UKFL206	25	0.9
161	130	90	UKFL207	30	1.17
175	144	100	UKFL208	35	1.54
188	148	108	UKFL209	40	1.89
197	157	115	UKFL210	45	2.27
224	184	130	UKFL211	50	3.06
250	202	140	UKFL212	55	3.79
258	210	155	UKFL213	60	4.48
275	225	165	UKFL215	65	5.48
290	233	180	UKFL216	70	7.46
305	248	190	UKFL217	75	9.03
320	265	205	UKFL218	80	10.89

If Bearing units required with Sleeve, designation for sleeve will be added e.g. UKFL205+H2305

Series: **UKF200**

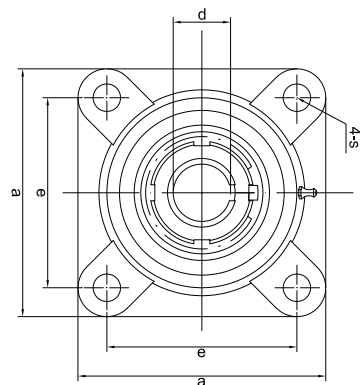

Principal dimensions		Designation	Shaft Dia (d)	Mass
a	e			
mm			mm	kg
95	70	UKF205	20	0.85
108	83	UKF206	25	1.16
117	92	UKF207	30	1.55
130	102	UKF208	35	1.94
137	105	UKF209	40	2.3
143	111	UKF210	45	2.59
162	130	UKF211	50	3.46
175	143	UKF212	55	4.33
187	149	UKF213	60	4.9
200	159	UKF215	65	7.02
208	165	UKF216	70	7.76
200	159	UKF215	65	7.02
208	165	UKF216	70	7.76
220	175	UKF217	75	10.08
235	187	UKF218	80	12.44

If Bearing units required with Sleeve, designation for sleeve will be added e.g. UKF205+H2305

Series: **UKP200**

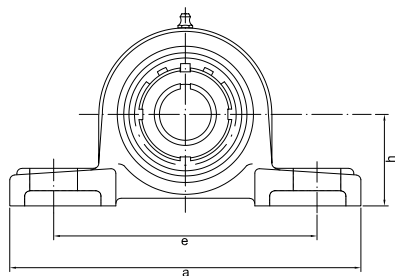

Principal dimensions			Designation	Shaft Dia (d)	Mass
a	e	h			
mm					
140	105	36.5	UKP205	20	0.86
160	121	42.9	UKP206	25	1.28
167	127	47.6	UKP207	30	1.67
184	137	49.2	UKP208	35	1.99
190	146	54	UKP209	40	2.29
206	159	57.2	UKP210	45	2.83
219	171	63.5	UKP211	50	3.46
241	184	69.8	UKP212	55	4.95
265	203	76.2	UKP213	60	5.06
275	217	82.6	UKP215	65	7.27
292	232	88.9	UKP216	70	8.36
310	247	95.2	UKP217	75	10.23
327	262	101.6	UKP218	80	12.34

If Bearing units required with Sleeve, designation for sleeve will be added e.g. UKFL205+H2305

Series: **UKT200**

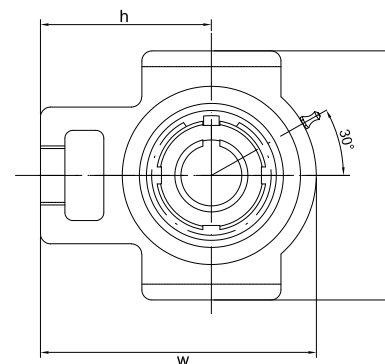

Principal dimensions			Designation	Shaft Dia (d)	Mass
a	w	h			
mm					
89	97	62	UKT205	20	0.86
102	113	70	UKT206	25	1.26
102	129	78	UKT207	30	2.5
114	144	89	UKT208	35	2.5
117	144	87	UKT209	40	2.51
117	149	90	UKT210	45	2.6
146	171	106	UKT211	50	4.26
146	194	119	UKT212	55	5.02
167	224	137	UKT213	60	6.56
167	232	140	UKT215	65	7.52
184	235	140	UKT216	70	8.56
198	260	162	UKT217	75	11.38
215	275	170	UKT218	80	14.94

If Bearing units required with Sleeve, designation for sleeve will be added e.g. UKF205+H2305

Plumber Blocks Housings



Plumber Blocks Housings

Plumber Block Housings help to form Bearing units, with Self-aligning Ball Bearings & Spherical Roller Bearings. They permit flexibility in the choice of Bearing, location on Shaft, Seals & lubrication. Made on modular principle using Cast Iron HT 200 JIS 5501, KG Housings are available in a wide range of sizes to suit various application requirements.



Plumber Blocks Housings

To allow slight adjustment in the position, KG Plumber Block Housings have two elongated holes for attachment bolts. The Bearing seat in the Housing bore is designed for non-locating Bearing arrangements. Bearing can move slightly in either direction to compensate Shaft elongation, which may happen due to thermal expansion.

Different housing variants and seal designs are available, making the use of tailored housings virtually unnecessary and enabling cost effective bearing arrangements to be made.

KG offers

- Low weight to strength ratio
- Ease of mounting and dismounting
- High strength and rigidity

Generally Bearings used in the Plumber Blocks are lubricated with grease, and since it lasts for a longer time, Plumber Blocks do not have re-lubrication holes. However, Bearing performance should be periodically monitored to ascertain re-lubrication requirements.

Special Felt Seals are provided along with KG Plumber Block Housings, for use under normal operating conditions. For more information on use of special Seals, please contact KG International FZCO.

Apart from the list of Plumber Block types presented in following pages, special types can also be developed to meet specific requirements. Technical information for such special Plumber Blocks which do not appear in our regular production program, can be made available whenever required.



Series: **SN 200**

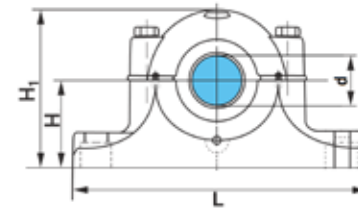

Principal dimensions				Designation	Mass
Shaft Dia (d)	L	H	H1		
mm					kg
25	165	40	75	SN 205	1.1
30	185	50	90	SN 206	1.7
35	185	50	95	SN 207	1.9
40	205	60	110	SN 208	2.6
45	205	60	112	SN 209	2.8
50	205	60	115	SN 210	3
55	255	70	130	SN 211	4.5
60	255	70	135	SN 212	5
65	275	80	150	SN 213	5.6
70	275	80	155	SN 214	6.2
75	280	80	155	SN 215	7
80	315	95	175	SN 216	9



Series: **SN 200**

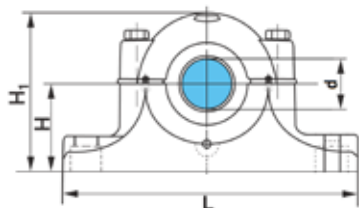

Principal dimensions				Designation	Mass
Shaft Dia (d)	L	H	H1		
mm					kg
85	320	95	185	SN 217	10
90	345	100	195	SN 218	13
95	345	112	210	SN 219	15
100	380	112	218	SN 220	19
110	410	125	240	SN 222	20
120	410	140	270	SN 224	25
130	445	150	290	SN 226	30
140	500	150	305	SN 228	38
150	530	160	325	SN 230	46

Series: **SN 500**

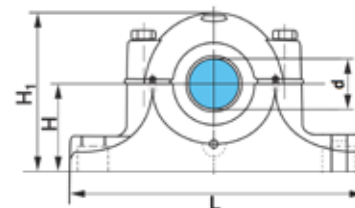

Principal dimensions				Designation	Mass	*Self aligning ball bearing		*Spherical roller bearing	
Shaft Dia (d)	L	H	H1						
mm					kg				
20	165	40	75	SN 505	1.30				
25	185	50	90	SN 506	1.74	1206K	2206K		
30	185	50	95	SN 507	1.90	1207K	2207K		
35	205	60	110	SN 508	3.00	1208K	2208K	22208K	
40	205	60	112	SN 509	3.10	1209K	2209K	22209K	
45	205	60	115	SN 510	3.30	1210K	2210K	22210K	
50	255	70	130	SN 511	4.60	1211K	2211K	22211K	
55	255	70	135	SN 512	5.30	1212K	2212K	22212K	
60	275	80	150	SN 513	6.50	1213K	2213K	22213K	
65	280	80	155	SN 515	6.19	1215K	2215K	22215K	
70	315	95	175	SN 516	8.17	1216K	2216K	22216K	
75	320	95	185	SN 517	10.60	1217K	2217K	22217K	
80	345	100	195	SN 518	11.5	1218K	2218K	22218K	23218K
85	345	112	210	SN 519	13.5	1219K	2219K	22219K	
90	380	112	223	SN 520	17.5	1220K	2220K	22220K	
100	410	125	245	SN 522	23.5	1222K	2222K	22222K	23222K
110	410	140	270	SN 524	23.2	-	-	22224K	23224K
115	445	150	290	SN 526	29	-	-	22226K	23226K
125	500	150	305	SN 528	36.5	-	-	22228K	23228K
135	530	160	325	SN 530	43.06	-	-	22230K	23232K
140	550	170	345	SN 532	48	-	-	22232K	23232K

*For locating ring and sleeve details, please refer to the next page.



Series: **SN 600**

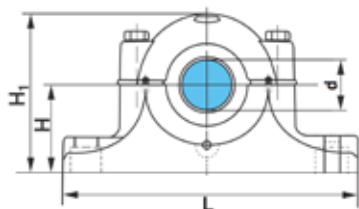

Principal dimensions				Designation	Mass	*Self aligning ball bearing		*Spherical roller bearing	
Shaft Dia (d)	L	H	H1						
mm									
20	185	50	90	SN 605	1.6	1305K	2305K		
25	185	50	95	SN 606	1.8	1306K			
30	205	60	110	SN 607	2.6	1307K	2307K		
35	205	60	115	SN 608	2.9	1308K	2308K	21308K	22308K
40	255	70	130	SN 609	4.1	1309K	2309K	21309K	22309K
45	255	70	135	SN 610	4.7	1310K	2310K	21310K	22310K
50	275	80	150	SN 611	5.8	1311K	2311K	21311K	22311K
55	280	80	155	SN 612	6.5	1312K	2312K	21312K	22312K
60	315	95	175	SN 613	8.7	1313K	2313K	21313K	22313K
65	345	100	195	SN 615	11.3	1315K	2315K	21315K	22315K
70	345	112	212	SN 616	12.6	1316K	2316K	21316K	22316K
75	380	112	223	SN 617	15	1317K	2317K	21317K	22317K
80	380	112	230	SN 618	22	1318K	2318K	21318K	22318K
85	410	125	250	SN 619	26.3	1319K	2319K	21319K	22319K
90	410	140	270	SN 620	31.5	1320K	2320K	21320K	22320K
100	450	150	300	SN 622	42	1322K	2322K	21322K	22322K
110	530	160	320	SN 624	60				22324K
115	550	170	340	SN 626	63.2				22326K
125	610	180	365	SN 628	94.5				22328K
135	650	190	385	SN 630	105				22330K

*For locating ring and sleeve details, please refer to the next page.

Series: **SN 500** locating ring and Adapter Sleeve Details

Housing No.	Bearing No.		Adapter Sleeve		Locating No.	Qty.
SN505	1205K		H205	HE205	SR52*5	2
	2205K	22205K	H305	HE305	SR52*7	1
SN506	1206K		H206	HE206	SR62*7	2
	2206K	22206K	H306	HE306	SR62*10	1
SN507	1207K		H207	HE207	SR72*8	2
	2207K	22207K	H307	HE307	SR72*10	1
SN508	1208K		H208	HE208	SR80*7.5	2
	2208K	22208K	H308	HE308	SR80*10	1
SN509	1209K		H209	HE209	SR85*6	2
	2209K	22209K	H309	HE309	SR85*8	1
SN510	1210K		H210	HE210	SR90*6.5	2
	2210K	22210K	H310	HE310	SR90*10	1
SN511	1211K		H211	HE211	SR100*6	2
	2211K	22211K	H311	HE311	SR100*8	1
SN512	1212K		H212	HE212	SR110*8	2
	2212K	22212K	H312	HE312	SR110*10	1
SN513	1213K		H213	HE213	SR120*10	2
	2213K	22213K	H313	HE313	SR120*12	1
SN515	1215K		H215	HE215	SR130*8	2
	2215K	22215K	H315	HE315	SR130*10	1
SN516	1216K		H216	HE216	SR140*8.5	2
	2216K	22216K	H316	HE316	SR140*10	1
SN517	1217K		H217	HE217	SR150*9	2
	2217K	22217K	H317	HE317	SR150*10	1
SN518	1218K		H218	HE218	SR160*10.2	2
	2218K	22218K	H318	HE318	SR160*11.2	2
		23218K	H2318	HE2318	SR160*10	1
SN519	1219K		H219	HE219	SR170*10.5	2
	2219K	22219K	H319	HE319	SR170*10	1
SN520	2220K	22220K	H320	HE320	SR180*12.1	2
		23220K	H2320	HE2320	SR180*10	1
SN522	2222K	22222K	H322	HE322	SR200*13.5	2
		23222K	H2322	HE2322	SR200*10	1
SN524		22224K	H3124	HE3124	SR215*14	2
		23224K	H2324	HE2324	SR215*10	1
SN526		22226K	H3126	HE3126	SR230*13	2
		23226K	H2326	HE2326	SR230*10	1
SN528		22228K	H3128	HE3128	SR250*15	2
		23228K	H2328	HE2328	SR250*10	1
SN530		22230K	H3130	HE3130	SR270*16.5	2
		23230K	H2330	HE2330	SR270*10	1
SN532		22232K	H3132	HE3132	SR290*17	2
		23232K	H2332	HE2332	SR290*10	1

Series: **SN 600** locating ring and Adapter Sleeve Details

Housing No.	Bearing No.		Adapter Sleeve		Locating No.	Qty.
SN606	1306K		H306	HE306	SR72*9	2
	2306K		H2306	HE2306	SR72*10	1
SN607	1307K		H307	HE307	SR80*10	2
	2307K		H2307	HE2307	SR80*10	1
SN608	1308K	21308K	H308	HE308	SR90*10	2
	2308K	22308K	H2308	HE2308	SR90*10	1
SN609	1309K	21309K	H309	HE309	SR100*10.5	2
	2309K	22309K	H2309	HE2309	SR100*10	1
SN610	1310K	21310K	H310	HE310	SR110*11.5	2
	2310K	22310K	H2310	HE2310	SR110*10	1
SN611	1311K	21311K	H311	HE311	SR120*12	2
	2311K	22311K	H2311	HE2311	SR120*10	1
SN612	1312K	21312K	H312	HE312	SR130*12.5	2
	2312K	22312K	H2312	HE2312	SR130*10	1
SN613	1313K	21313K	H313	HE313	SR140*12.5	2
	2313K	22313K	H2313	HE2313	SR140*10	1
SN615	1315K	21315K	H315	HE315	SR160*14	2
	2315K	22315K	H2315	HE2315	SR160*10	1
SN616	1316K	21316K	H316	HE316	SR170*14.5	2
	2316K	22316K	H2316	HE2316	SR170*10	1
SN617	1317K	21317K	H317	HE317	SR180*14.5	2
	2317K	22317K	H2317	HE2317	SR180*10	1
SN618	1318K		H318	HE318	SR190*15.5	2
	2318K	22318K	H2318	HE2318	SR190*10	1
SN619	1319K		H319	HE319	SR200*16	2
	2319K	22319K	H2319	HE2319	SR200*10	1
SN620	1320K		H320	HE320	SR215*18	2
	2320K	22320K	H2320	HE2320	SR215*10	1
SN622	1322K		H322	HE322	SR240*20	2
	2322K	22322K	H2322	HE2322	SR240*10	1
SN624		22324K	H2324	HE2324	SR260*10	1
SN626		22326K	H2326	HE2326	SR280*10	1
SN628		22328K	H2328	HE2328	SR300*10	1
SN630		22330K	H2330	HE2330	SR320*10	1

Series: **SNU 500**

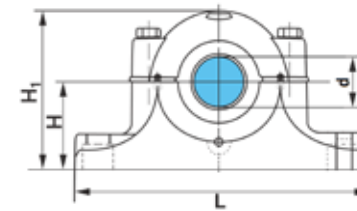

Principal dimensions				Designation	Mass
Shaft Dia (d)	L	H	H1		
mm					kg
20	165	40	72	SNU505	1.7
25	185	50	87	SNU506	2.2
30	185	50	92	SNU507	2.4
35	205	60	106	SNU508	3.2
40	205	60	109	SNU509	3.5
45	205	60	112	SNU510	3.85
50	255	70	127	SNU511	5.2
55	255	70	133	SNU512	6.7
60	275	80	148	SNU513	7.9
65	280	80	154	SNU515	7.7
70	315	95	175	SNU516	11
75	320	95	181	SNU517	12.7
80	345	100	192	SNU518	14.8
85	345	112	209	SNU519	15.5
90	380	112	215	SNU520	18.4
100	410	125	239	SNU522	24.8
110	410	140	271	SNU524	32.2
115	445	150	290	SNU526	39.8
125	500	150	302	SNU528	48.8
135	530	160	323	SNU530	56.5
140	550	170	344	SNU532	63.5



Adapter and Withdrawal Sleeves



Adapter and Withdrawal Sleeves

Adapter sleeves are mostly used for locating bearing with tapered bore on cylindrical seating of shafts and it can be located on any position of shaft while Withdrawal sleeve can be used to mount bearings with taper bore on cylindrical seating of stepped shafts.



Adapter and Withdrawal sleeves

- Facilitate mounting of Tapered Bore Self-aligning Ball Bearings, Spherical Roller Bearings, and Cylindrical Roller Bearings, on cylindrical Shafts
- Help to mount Bearings on a smooth Shaft, at any location
- Enable easy mounting and dismounting of Bearings
- Are available for Shafts with both metric and inch dimensions

Adapter Sleeve Selection Guide

Adapter Sleeve Series	Bearing Types			
	Deep Groove Ball Bearings	Self-aligning Ball Bearings	Spherical Roller Bearings	Cylindrical Roller Bearings
H 2	6211K - 6222K	1204K - 1222K	-	N 206K - N 222K NU 204K - NU 222K
H 3	6311K - 6322K	1304K - 1322K 2204K - 2222K	22205K - 22222K 21304K - 21322K	NU2205K - NU2222K N306K - N322K NU304K - NU322K
H 23	-	2304K - 2322K	23218K - 23256K 22308K - 22356K	NU2305K - NU2356K
H 30	6224K - 6240K	-	23024K - 230/500K	N224K - N264K NU224K - NU264K N344K - N356K NU344K - NU356K
H 31	6324K - 6340K	-	23122K - 231/500K 22224K - 22264K	NU2224K - NU2264K N324K - N340K NU324K - NU340K
H 32	-	-	23260K - 232/500K	-



Adapter and Withdrawal sleeves

Apart from the list of items presented in the following pages, many other special type of Adapter Sleeves have also been developed to meet specific application requirement. Technical information for such sleeves can be made available whenever required

Adapter sleeve

It is most commonly used components for locating bearings with a tapered bore onto a cylindrical seat as they can be used on plain or stepped shafts. They are easy to install and require no additional location on the shaft. When adapter sleeves are used on plain shafts, the bearing can be located at any position on the shaft. Bearings can be accurately positioned axially thereby facilitating bearing mounting and dismounting.

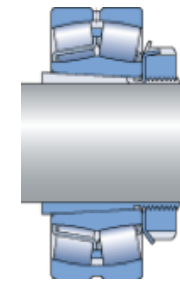

Withdrawal sleeve

To mount bearings with a tapered bore on the cylindrical seat of stepped shafts. The sleeve is pressed into the bore of the bearing inner ring, which abuts a shaft shoulder or similar fixed component. The sleeve is located on the shaft by a *nut or an *end plate.

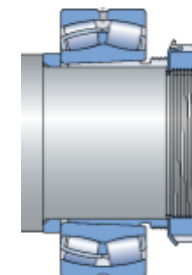

*Note: Nut or end plate are not supplied along with the sleeve.



Adapter Sleeves Series: H2

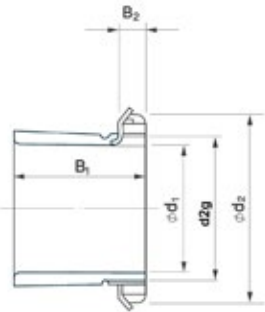

Principal dimensions					Designation	Mass
d ₁	d ₂	B ₁	B ₂ ~ Apprx	d2g Thread size		
mm						
14	28	21	6	M17X1	H203	0.03
17	32	24	7	M20X1	H204	0.041
20	38	26	8	M25X1.5	H205	0.07
25	45	27	8	M30X1.5	H206	0.099
30	52	29	9	M35X1.5	H207	0.125
35	58	31	10	M40X1.5	H208	0.174
40	65	33	11	M45X1.5	H209	0.226
45	70	35	12	M50X1.5	H210	0.274
50	75	37	12	M55X2	H211	0.308
55	80	38	13	M60X2	H212	0.346
60	85	40	14	M65X2	H213	0.401
60	92	41	14	M70X2	H214	0.555
65	98	43	15	M75X2	H215	0.708
70	105	46	17	M80X2	H216	0.881
75	110	50	18	M85X2	H217	1.02
80	120	52	18	M90X2	H218	1.18
85	125	55	19	M95X2	H219	1.37
90	130	58	20	M100X2	H220	1.49
95	140	60	20	M105X2	H221	1.7
100	145	63	21	M110X2	H222	1.93

Adapter Sleeves Series: H3

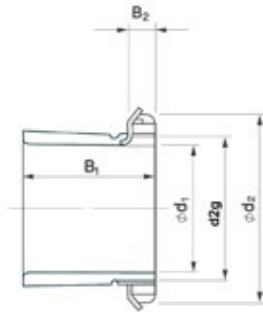

Principal dimensions					Designation	Mass
d ₁	d ₂	B ₁	B ₂ ~ Apprx	d2g Thread size		
mm						
17	32	28	7	M20X1	H304	0.045
20	38	29	8	M25X1.5	H305	0.075
25	45	31	8	M30X1.5	H306	0.109
30	52	35	9	M35X1.5	H307	0.142
35	58	36	10	M40X1.5	H308	0.189
40	65	39	11	M45X1.5	H309	0.248
45	70	42	12	M50X1.5	H310	0.302
50	75	45	12	M55X2	H311	0.345
55	80	47	13	M60X2	H312	0.393
60	85	50	14	M65X2	H313	0.459
60	92	52	14	M70X2	H314	0.723
65	98	55	15	M75X2	H315	0.83
70	105	59	17	M80X2	H316	1.03
75	110	63	18	M85X2	H317	1.18
80	120	65	18	M90X2	H318	1.37
85	125	68	19	M95X2	H319	1.56
90	130	71	20	M100X2	H320	1.69
95	140	74	20	M105X2	H321	1.93
100	145	77	21	M110X2	H322	2.18



Adapter Sleeves Series: **H3**

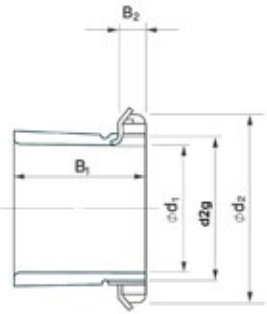

Principal dimensions					Designation	Mass
d ₁	d ₂	B ₁	B ₂ ~ Apprx	d2g Thread size		
mm						kg
110	145	72	22	M120X2	H3024	1.96
115	155	80	23	M130X2	H3026	2.85
125	165	82	24	M140X2	H3028	3.18
135	180	87	26	M150X2	H3030	3.9
140	190	93	28	M160X3	H3032	5.44
150	200	101	29	M170X3	H3034	6.25
160	210	109	30	M180X3	H3036	7.18
170	220	112	31	M190X3	H3038	7.8
180	240	120	32	M200X3	H3040	9.5
200	260	126	30	Tr220X4	H3044	10.5
220	290	133	34	Tr240X4	H3048	13.8
240	310	145	34	Tr260X4	H3052	16
260	330	152	38	Tr280X4	H3056	18.5
280	360	168	42	Tr300X4	H3060	23.8
300	380	171	42	Tr320X5	H3064	25.4
320	400	187	45	Tr340X5	H3068	30
340	420	188	45	Tr360X5	H3072	31.6
360	450	193	48	Tr380X5	H3076	36.2
380	470	210	52	Tr400X5	H3080	40.7

Adapter Sleeves Series: **H23**

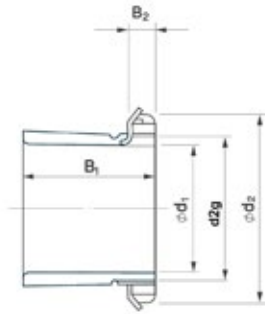

Principal dimensions					Designation	Mass
d ₁	d ₂	B ₁	B ₂ ~ Apprx	d2g Thread size		
mm						kg
17	32	31	7	M20X1	H2304	0.049
20	38	35	8	M25X1.5	H2305	0.087
25	45	38	8	M30X1.5	H2306	0.126
30	52	43	9	M35X1.5	H2307	0.165
35	58	46	10	M40X1.5	H2308	0.224
40	65	50	11	M45X1.5	H2309	0.28
45	70	55	12	M50X1.5	H2310	0.362
50	75	59	12	M55X2	H2311	0.42
55	80	62	13	M60X2	H2312	0.48
60	85	65	14	M65X2	H2313	0.556
60	92	68	14	M70X2	H2314	0.897
65	98	73	15	M75X2	H2315	1.05
70	105	78	17	M80X2	H2316	1.28
75	110	82	18	M85X2	H2317	1.45
80	120	86	18	M90X2	H2318	1.7
85	125	90	19	M95X2	H2319	1.94



Adapter Sleeves Series: H23

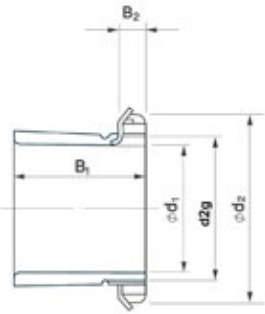

Principal dimensions					Designation	Mass
d ₁	d ₂	B ₁	B ₂ ~ Apprx	d2g Thread size		
mm						kg
90	130	97	20	M100X2	H2320	2.15
95	140	101	20	M105X2	H2321	2.45
100	145	105	21	M110X2	H2322	2.74
110	155	112	22	M120X2	H2324	3.2
115	165	121	23	M130X2	H2326	4.6
125	180	131	24	M140X2	H2328	5.52
135	195	139	26	M150X2	H2330	6.6
140	210	147	28	M160X3	H2332	9.15
150	220	154	29	M170X3	H2334	10.4
160	230	161	30	M180X3	H2336	11.3
170	240	169	31	M190X3	H2338	12.6
180	250	176	32	M200X3	H2340	13.9
200	280	183	32	Tr220X4	H2344	16.6
220	300	196	34	Tr240X4	H2348	19.7
240	330	208	36	Tr260X4	H2352	24.2
260	350	221	38	Tr280X4	H2356	27.8

Adapter Sleeves Series: H31

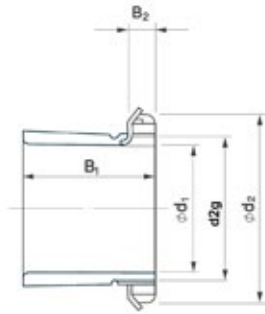

Principal dimensions					Designation	Mass
d ₁	d ₂	B ₁	B ₂ ~ Apprx	d2g Thread size		
mm						kg
90	130	76	20	M100X2	H3120	1.81
100	145	81	21	M110X2	H3122	2.25
110	155	88	22	M120X2	H3124	2.64
115	165	92	23	M130X2	H3126	3.66
125	180	97	24	M140X2	H3128	4.34
135	195	111	26	M150X2	H3130	5.54
140	210	119	28	M160X3	H3132	7.7
150	220	122	29	M170X3	H3134	8.4
160	230	131	30	M180X3	H3136	9.5
170	240	141	31	M190X3	H3138	10.8
180	250	150	32	M200X3	H3140	12.1
200	280	158	32	Tr220X4	H3144	14.7
220	300	169	34	Tr240X4	H3148	17.3
240	330	187	36	Tr260X4	H3152	22
260	350	192	38	Tr280X4	H3156	24.5
280	380	208	40	Tr300X4	H3160	30.3
300	400	226	42	Tr320X5	H3164	35
320	440	254	55	Tr340X5	H3168	49.5
340	460	259	58	Tr360X5	H3172	54.5
360	490	264	60	Tr380X5	H3176	61.6
380	520	272	62	Tr400X5	H3180	70.1
400	540	304	70	Tr420X5	H3184	84
410	560	307	70	Tr440X5	H3188	103
430	580	326	75	Tr460X5	H3192	116
450	620	335	75	Tr480X5	H3196	133



Adapter Sleeves Series: HE2

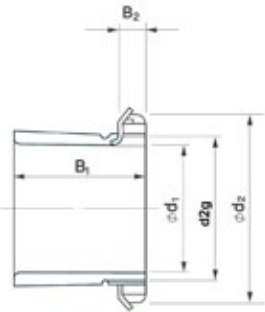

Principal dimensions					Designation	Mass
d ₁	d ₂	B ₁	B ₂ ~ Apprx	d _{2g} Thread size		
inch	mm					kg
1	30	27	8	M30X1.5	HE 206	0.10
1 1/8	35	29	9	M35X1.5	HE 207	0.13
1 1/4	40	31	10	M40X1.5	HE 208	0.17
1 1/2	45	33	11	M45X1.5	HE 209	0.23
1 3/4	50	35	12	M50X1.5	HE 210	0.27
2	55	37	12,5	M55X2	HE 211	0.31
2 1/8	60	38	13	M60X2	HE 212	0.35
2 1/4	65	40	14	M65X2	HE 213	0.40
2 3/8	70	41	14	M70X2	HE 214	0.59
2 1/2	75	43	15	M75X2	HE 215	0.71
2 3/4	80	46	17	M80X2	HE 216	0.88
3	85	50	18	M85X2	HE 217	1.02

Adapter Sleeves Series: HE3

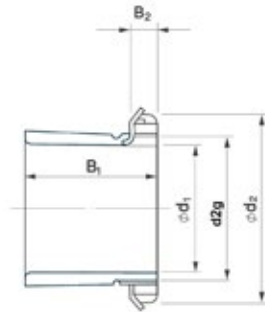

Principal dimensions					Designation	Mass
d ₁	d ₂	B ₁	B ₂ ~ Apprx	d _{2g} Thread size		
inch	mm					kg
1	30	31	45	M30X1.5	HE 306	0.11
1 1/8	35	35	52	M35X1.5	HE 307	0.14
1 1/4	40	36	58	M40X1.5	HE 308	0.19
1 1/2	45	39	65	M45X1.5	HE 309	0.25
1 3/4	50	42	70	M50X1.5	HE 310	0.30
2	55	45	75	M55X2	HE 311	0.35
2 1/8	60	47	80	M60X2	HE 312	0.39
2 1/4	65	50	85	M65X2	HE 313	0.46
2 3/8	70	52	92	M70X2	HE 314	0.72
2 1/2	75	55	98	M75X2	HE 315	0.83
2 3/4	80	59	105	M80X2	HE 316	1.03
3	85	63	110	M85X2	HE 317	1.18



Withdrawal Sleeves Series: AH2

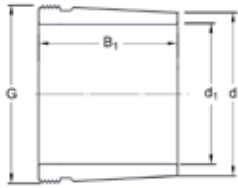

Principal dimensions				Designation	Mass
d	d ₁	B ₁	G2 Thread Size		
mm					kg
40	35	25	M45X1.5	AH208	0.08
45	40	26	M50x1.5	AH209	0.09
50	45	28	M55x2	AH210	0.12
55	50	29	M60x2	AH211	0.13
60	55	32	M65x2	AH212	0.16
65	60	32,5	M75X2	AH213	0.21
65	60	32,5	M70X2	AH213G	0.18
70	65	33,5	M80X2	AH214	0.23
70	65	33,5	M75X2	AH214G	0.2
75	70	34,5	M85X2	AH215	0.26
75	70	34,5	M80X2	AH215G	0.22
80	75	35,5	M90X2	AH216	0.28
85	80	38,5	M95X2	AH217	0.33
90	85	40	M100X2	AH218	0.36

Withdrawal Sleeves Series: AH2

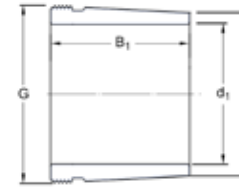

Principal dimensions				Designation	Mass
d	d ₁	B ₁	G2 Thread Size		
mm					kg
95	90	43	M105X2	AH219	0.42
100	95	45	M110X2	AH220	0.46
110	105	50	M120X2	AH222	0.57
120	115	53	M130X2	AH224	0.67
130	115	53	M140X2	AH226	0.72
140	135	56	M150X2	AH228	0.83
150	145	60	M160X3	AH230	0.97
160	150	64	M170X3	AH232	1.71
170	160	69	M180X3	AH234	1.98
180	170	69	M190X3	AH236	2.1
190	180	73	Tr205X4	AH238	2.57
190	180	73	M200X3	AH238G	2.36
200	190	77	Tr215X4	AH240	2.88
200	190	77	Tr210X4	AH240G	2.43



Withdrawal Sleeves Series: AH3

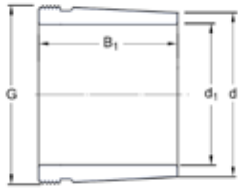

Principal dimensions				Designation	Mass
d	d ₁	B ₁	G2 Thread Size		
mm					
40	35	29	M45X1.5	AH308	0.09
45	40	31	M50x1.5	AH309	0.11
65	60	42	M75X2	AH313	0.27
65	60	42	M70X2	AH313G	0.23
70	65	43	M80X2	AH314	0.29
70	65	43	M75X2	AH314G	0.26
75	70	45	M85X2	AH315	0.33
75	70	45	M80X2	AH315G	0.29
80	75	48	M90X2	AH316	0.68
160	150	77	M170X3	AH3032	2.09
160	150	77	M170X3	AH3032H	2.09
170	160	85	M180X3	AH3034	2.48
170	160	85	M180X3	AH3034H	2.48
180	170	92	M190X3	AH3036	2.87
180	170	92	M190X3	AH3036H	2.87
190	180	96	Tr205X4	AH3038	3.42
190	180	96	M200X3	AH3038G	3.19
190	180	96	M200X3	AH3038GH	3.49
190	180	96	Tr205X4	AH3038H	3.42
200	190	102	Tr215X4	AH3040	3.86
200	190	102	Tr210X4	AH3040G	3.62
200	190	102	Tr210X4	AH3040G-H	3.62
200	190	102	Tr215X4	AH3040-H	3.86
220	200	111	Tr235X4	AH3044	7.47

Withdrawal Sleeves Series: AH3

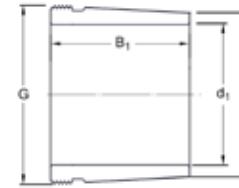

Principal dimensions				Designation	Mass
d	d ₁	B ₁	G2 Thread Size		
mm					
220	200	111	Tr230X4	AH3044G	7.18
220	200	111	Tr230X4	AH3044G-H	7.18
220	200	111	Tr235X4	AH3044-H	7.47
240	220	116	Tr260X4	AH3048	8.92
240	220	116	Tr260X4	AH3048-H	8.92
260	240	128	Tr280X4	AH3052	10.8
260	240	128	Tr280X4	AH3052-H	10.8
280	260	131	Tr300X4	AH3056	12
280	260	131	Tr300X4	AH3056-H	12
300	280	145	Tr320X5	AH3060	14.4
300	280	145	Tr320X5	AH3060-H	14.4
320	300	149	Tr340X5	AH3064G-H	15.9
320	300	149	Tr345X5	AH3064-H	16.5
340	320	162	Tr360X5	AH3068G-H	18.6
340	320	162	Tr365X5	AH3068-H	19.2
360	340	167	Tr380X5	AH3072G-H	20.5
360	340	167	Tr385X5	AH3072-H	21.2
380	360	170	Tr400X5	AH3076G-H	22.1
380	360	170	Tr410X5	AH3076-H	23.6
400	380	183	Tr420X5	AH3080G-H	25.4
400	380	183	Tr430X5	AH3080-H	27.1
420	400	186	Tr440X5	AH3084G-H	27.2
420	400	186	Tr450X5	AH3084-H	29.1



Withdrawal Sleeves Series: AH23

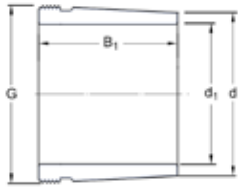

Principal dimensions				Designation	Mass
d	d ₁	B ₁	G2 Thread Size		
mm					kg
15	35	40	M45X1.5	AH2308	0.13
45	40	44	M50x1.5	AH2309	0.17
65	60	61	M75X2	AH2313	0.42
65	60	61	M70X2	AH2313G	0.36
95	90	85	M105X2	AH2319	0.91
160	150	140	M180X3	AH2332	4.77
160	150	140	M170X3	AH2332G	4.26
160	150	140	M170X3	AH2332GH	4.26
160	150	140	M180X3	AH2332H	4.77
170	160	146	M190X3	AH2334	5.32
170	160	146	M180X3	AH2334G	4.78
170	160	146	M180X3	AH2334GH	4.78
170	160	146	M190X3	AH2334H	5.32
180	170	154	M190X3	AH2236GH	5.42
180	170	154	M200X3	AH2336	6.04
180	170	154	M190X3	AH2336G	5.42
180	170	154	M200X3	AH2336H	6.04

Withdrawal Sleeves Series: AH24

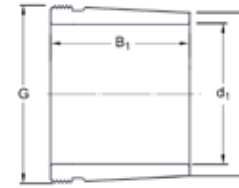

Principal dimensions				Designation	Mass
d	d ₁	B ₁	G2 Thread Size		
mm					kg
100	95	62	M105X2	AH24020	0.5
110	105	73	M115X2	AH24022	0.65
120	115	73	M125X2	AH24024	0.71
130	125	83	M135X2	AH24026	0.89
140	135	83	M145X2	AH24028	0.96
150	145	90	M155X3	AH24030	1.12
160	150	95	M170X3	AH24032	2.31
170	160	106	M180X3	AH24034	2.76
180	170	116	M190X3	AH24036	3.21
190	180	118	M200X3	AH24038	3.48
200	190	127	Tr210X4	AH24040	3.96
220	200	138	Tr230X4	AH24044	8.22
220	200	138	Tr230X4	AH24044-H	8.22
240	220	138	Tr250X4	AH24048	9.03
240	220	138	Tr250X4	AH24048-H	9.03
260	240	162	Tr270X4	AH24052	11.6
260	240	162	Tr280X4	AH24052G	12.3
260	240	162	Tr280X4	AH24052G-H	12.3
260	240	162	Tr270X4	AH24052-H	11.6



Withdrawal Sleeves Series: AH24

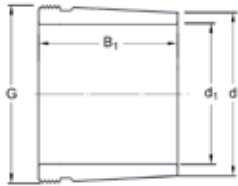

Principal dimensions				Designation	Mass
d	d ₁	B ₁	G2 Thread Size		
mm					kg
280	260	162	Tr290X4	AH24056	12.6
280	260	162	Tr300X4	AH24056G	13.4
280	260	162	Tr300X4	AH24056G-H	13.4
280	260	162	Tr290X4	AH24056-H	12.6
300	280	184	Tr310X4	AH24060	15.5
300	280	184	Tr320X5	AH24060G	16.4
300	280	184	Tr320X5	AH24060G-H	16.4
300	280	184	Tr310X4	AH24060-H	15.5
300	300	184	Tr340X5	AH24064G-H	17.5
320	300	184	Tr330X5	AH24064-H	16.6
340	320	206	Tr360X5	AH24068-H	21.1
360	340	206	Tr380X5	AH24072-H	22.3
380	360	208	Tr400X5	AH24076-H	24
400	380	228	Tr420X5	AH24080-H	27.8
420	400	230	Tr440X5	AH24084-H	29.6
440	420	242	Tr460X5	AH24088-H	32.8
460	440	250	Tr480X5	AH24092-H	35.6
480	460	250	Tr500X5	AH24096-H	37.2

Withdrawal Sleeves Series: AH32

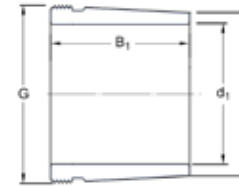

Principal dimensions				Designation	Mass
d	d ₁	B ₁	G2 Thread Size		
mm					kg
85	80	60	M95X2	AH3217	0.52
160	150	124	M180X3	AH3232	4.08
160	150	124	M170X3	AH3232G	3.65
160	150	124	M170X3	AH3232GH	3.65
160	150	124	M180X3	AH3232H	4.08
170	160	134	M190X3	AH3234	4.83
170	160	134	M180X3	AH3234G	4.29
170	160	134	M180X3	AH3234GH	4.29
170	160	134	M190X3	AH3234H	4.83
180	170	140	M200X3	AH3236	5.39
180	170	140	M190X3	AH3236G	4.8
180	170	140	M190X3	AH3236GH	4.8
180	170	140	M200X3	AH3236H	5.39
190	180	145	Tr210X4	AH3238	5.92
190	180	145	M200X3	AH3238G	5.3
190	180	145	M200X3	AH3238G-H	5.3
190	180	145	Tr210X4	AH3238-H	5.92
200	190	153	Tr220X4	AH3240	6.61
200	190	153	Tr220X4	AH3240-H	6.61



Withdrawal Sleeves Series: AH33

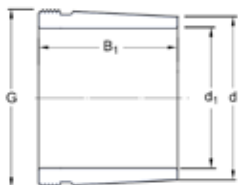

Principal dimensions				Designation	Mass
d	d ₁	B ₁	G2 Thread Size		
mm					kg
40	35	44	M45X1.5	AH3308	0.15
45	40	47	M50X1.5	AH3309	0.18
50	45	54	M55X2	AH3310	0.24
55	50	60	M60X2	AH3311	0.3
60	55	65	M65X2	AH3312	0.41
65	60	71	M75X2	AH3313	0.79
70	65	76	M80X2	AH3314	0.57
80	75	81	M90X2	AH3316	0.71
85	80	86	M95X2	AH3317	0.81
90	85	87	M100X2	AH3318	0.88
95	90	94	M105X2	AH3319	1.03
100	95	99	M110X2	AH3320	1.16
110	105	108	M125X2	AH3322	1.54
120	115	123	M135X2	AH3324	1.99
130	125	131	M145X2	AH3326	2.36
140	135	138	M155X3	AH3328	2.72
150	145	152	M165X3	AH3330	3.36
160	150	88	M180X3	AH332	2.76
160	150	88	M170X3	AH332G	2.42
160	150	160	M180X3	AH3332	5.58
160	150	160	M180X3	AH3332H	5.58
170	160	164	M190X3	AH3334	6.11
170	160	164	M190X3	AH3334H	6.11
170	160	93	M180X3	AH334	3.13
170	160	93	M180X3	AH334G	2.75

Withdrawal Sleeves Series: AHX23

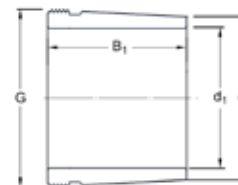

Principal dimensions				Designation	Mass
d	d ₁	B ₁	G2 Thread Size		
mm					kg
50	45	50	M55x2	AHX2310	0.22
55	50	54	M60x2	AHX2311	0.26
60	55	58	M65x2	AHX2312	0.32
70	65	64	M80X2	AHX2314	0.47
70	65	64	M75X2	AHX2314G	0.42
75	70	68	M85X2	AHX2315	0.54
75	70	68	M80X2	AHX2315G	0.48
80	75	71	M90X2	AHX2316	0.61
85	80	74	M95X2	AHX2317	0.68
90	85	79	M100X2	AHX2318	0.78
100	95	90	M110X2	AHX2320	1.03
110	105	98	M125X2	AHX2322	1.38
110	105	98	M120X2	AHX2322G	1.26
120	115	105	M135X2	AHX2324	1.64
120	115	105	M130X2	AHX2324G	1.5
130	125	115	M145X2	AHX2326	2
130	125	115	M140X2	AHX2326G	1.84
140	135	125	M155X3	AHX2328	2.4
140	135	125	M150X2	AHX2328G	2.21
150	145	135	M165X3	AHX2330	2.88
150	145	135	M160X3	AHX2330G	2.64



Withdrawal Sleeves Series: **AHX30**

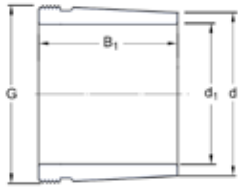

Principal dimensions				Designation	Mass
d	d ₁	B ₁	G2 Thread Size		
mm					
120	115	60	M130X2	AHX3024	0.77
130	125	67	M140X2	AHX3026	0.94
140	135	68	M150X2	AHX3028	1.03
150	145	72	M160X3	AHX3030	1.18
440	420	194	Tr460X5	AHX3088G-H	30
440	420	194	Tr470X5	AHX3088-H	31.9
460	440	202	Tr480X5	AHX3092G-H	32.9
460	440	202	Tr490X5	AHX3092G-H	35.1
480	460	205	Tr500X5	AHX3096G-H	35
480	460	205	Tr520X6	AHX3096-H	39.7

Withdrawal Sleeves Series: **AHX31**

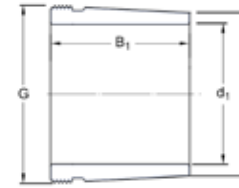

Principal dimensions				Designation	Mass
d	d ₁	B ₁	G2 Thread Size		
mm					
50	45	35	M55x2	AHX310	0.14
55	50	37	M60x2	AHX311	0.17
60	55	40	M65x2	AHX312	0.2
85	80	52	M95X2	AHX317	0.44
90	85	53	M100X2	AHX318	0.48
95	90	57	M105X2	AHX319	0.55
100	95	64	M110X2	AHX3120	0.67
110	105	68	M120X2	AHX3122	0.79
120	115	75	M130X2	AHX3124	0.97
130	125	78	M140X2	AHX3126	1.1
140	135	83	M150X2	AHX3128	1.29
150	145	96	M165X3	AHX3130	1.81
150	145	96	M160X3	AHX3130G	1.66
440	420	270	Tr460X5	AHX3188G-H	44.9
440	420	270	Tr480X5	AHX3188-H	49.7
460	440	285	Tr480X5	AHX3192G-H	50.3
460	440	285	Tr510X6	AHX3192-H	58
460	460	295	Tr500X5	AHX3192G-H	54.8
480	460	295	Tr530X6	AHX3196-H	63.3



Withdrawal Sleeves Series: **AHX32**

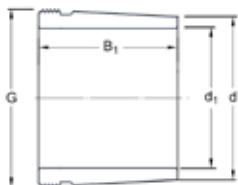

Principal dimensions				Designation	Mass
d	d ₁	B ₁	G2 Thread Size		
mm					kg
90	85	63	M100X2	AHX3218	0.58
90	90	67	M105X2	AHX3219	0.67
100	95	59	M110X2	AHX320	0.6
100	95	73	M110X2	AHX3220	0.78
110	105	63	M120X2	AHX322	0.73
110	105	82	M120X2	AHX3222A	0.98
120	115	90	M130X2	AHX3224A	1.22
120	115	69	M130X2	AHX324	0.89
130	125	98	M145X2	AHX3226	1.61
130	125	98	M140X2	AHX3226G	1.48
130	125	74	M140X2	AHX326	1.05
140	135	104	M155X3	AHX3228	1.86
140	135	104	M150X2	AHX3228G	1.72
140	135	77	M150X2	AHX328	1.18
150	145	114	M165X3	AHX3230	2.25
150	145	114	M160X3	AHX3230G	2.09
440	420	330	Tr460X5	AHX3288G-H	58.2
440	420	330	Tr480X5	AHX3288-H	63.7
460	440	349	Tr480X5	AHX3292G-H	65.6
460	440	349	Tr510X6	AHX3292-H	74.6
480	460	364	Tr500X5	AHX3296G-H	72.4
480	460	364	Tr530X6	AHX3296-H	82.2

Withdrawal Sleeves Series: **AHX33**

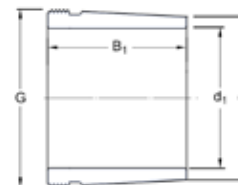

Principal dimensions				Designation	Mass
d	d ₁	B ₁	G2 Thread Size		
mm					kg
75	70	81	M82X2	AHX3315	0.66
150	145	83	M160X3	AHX330	1.54
150	145	83	M160X3	AHX330G	1.39



Other type of Bearings



Other type of Bearings

Many types of Bearings have been designed to meet the specific requirements of Automotive, Agricultural, Industrial and Other types of applications.



KG has developed numerous Automotive Agricultural, Industrial applications as under

- Wheel Applications
- Clutch Bearings
- Steering Assemblies
- Car Air Conditioners
- Hub Units with and without ABS
- General Automotive and Agricultural Bearings
- Tensioner Bearings
- Alternator Bearings
- Water Pump bearings- they can have either two rows of ball bearings or one row of ball bearings and one row of roller bearings,
- UV joints Bearings (Cross Bearings)
- Special customized Bearings
- Agriculture hub (Agri Hub) bearings
- Agriculture ST Series with round and square bore
- Agriculture PX Series with square bore
- Balls for Industrial applications
- Track Roller Bearings
- Slewing Bearings

Apart from above specially developed Automotive Bearings, many standard Bearings are also used in Automotive applications; few of them are mentioned in following pages.

KG Agri Hub Bearings

The Agriculture Hub is an easy fit compact and integrated solution for agricultural equipment, which is greased and sealed. The hub unit consists of a flanged outer ring that is pre-drilled and taped to accommodate the disc and an Inner ring which is fitted with a threaded stub shaft to enable easy mounting on virtually any implement arm.

Main features of KG Agrihub Bearings

- Optimized interior design
- High capacity bearing with rigid design to withstand shock loads
- High performance sealing to prevent dust, snow, mud, water
- Corrosion resistant to fertilizers and jet cleaning
- Angular Contact Ball Bearings with split inner ring
- Anti-contamination cap for the disc replacement
- Designed to be maintenance free and fit the customer's equipment

More details about **KG Agri hub Bearings** are available on coming pages and **KG Agri Hub leaflet** or you can contact **KG International FZCO**.

KG Slewing Bearings

Slewing rings have a high load carrying capacity, a versatile range of applications and are highly cost-effective. A single slewing bearing can reliably support radial, axial and tilting moment loads. So, in many cases, bearing arrangements comprising a combination of radial and axial bearings can be replaced with a single slewing bearing.

This reduces, in some cases considerably, the costs and work required in the design of the adjacent construction and the fitting of bearings. It is made up of mounting holes, inner gear or outer gear, grease hole and sealing device. It has many positive characteristics: compact structure, light weight, good rigidity, steady speed and high precision.

KG offers following Slewing Bearing variants

- Light Series One Row Ball Bearings
- One Row Ball Flanged Bearing, External Toothed
- One Row Ball Flanged Bearing, Internal Toothed
- One Row Ball Flanged Bearing, Untoothed
- One Row Ball Bearing, External Toothed
- One Row Ball Bearing, Internal Toothed
- One Row Ball Bearing, Untoothed
- Double Row Ball Bearing, External Toothed
- Double Row Ball Bearing, Internal Toothed
- One Row Crossed Roller Bearing, External Toothed
- One Row Crossed Roller Bearing, Internal Toothed
- One Row Crossed Roller Untoothed
- Triple Row Roller Bearing, External Toothed
- Triple Row Roller Bearing, Internal Toothed
- Customized design Slewing Bearings

For more details, please refer to our **KG Slewing Bearing Catalogue and leaflet** or you can contact **KG International FZCO**.

The information and list of Bearings presented in following pages is for reference purposes only.

Apart from the list of items presented, other special type of Bearings have also been developed to meet specific application requirements. Technical information for such Bearings, that do not appear in our regular production program, can be made available whenever required.

If your application requires special bearing boundary dimensions, load ratings and speed, grease we can provide customized bearing solutions. For further information Please contact **KG International FZCO, Dubai**



Wheel Bearings

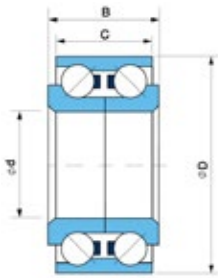

Principal dimensions				KG Bearing No.	Bearing No.	Mass		
d	D	B	C				kg	KOYO
mm								
25.00	52.00	20.60	20.60	WB2552-206	DAC255200206	0.19		
25.00	52.00	37.00	37.00	WB2552-37	DAC25520037	0.31		546467, 576467
25.00	52.00	43.00	43.00	WB2552-43	DAC25520043	0.36		
25.00	55.00	43.00	43.00	WB2555-43	DAC25550043	0.44		803837
25.00	56.00	32.00	32.00	WB2556-32	DAC25560032	0.34		445979
27.00	53.00	43.00	43.00	WB2753-43	DAC27530043	0.34		
27.00	60.00	50.00	50.00	WB2760-50	DAC27600050	0.56		
28.00	58.00	42.00	42.00	WB2858-42	DAC28580042	0.47	DAC2858WCS47, DAC2858AWCS40	
28.00	61.00	42.00	42.00	WB2861-42	DAC28610042	0.56	DAC286142AWCS40, DAC28614AW	
29.00	53.00	37.00	37.00	WB2953-37	DAC29530037	0.35		
30.00	58.00	42.00	42.00	WB3058-42	DAC30580042	0.40		
30.00	60.00	37.00	37.00	WB3060-37	DAC30600037	0.42	DAC3060372RS	-581736
30.00	60.03	37.00	37.00	WB306003-37	DAC30600337	0.42	DAC3060W	529891AB, 545312, 581736
30.00	64.00	42.00	42.00	WB3064-42	DAC30640042	0.49	DAC3064W2RKBCS28	
30.00	65.00	26.40	26.40	WB3065-264	DAC306500264	0.36		

Equivalent Bearing No. In Other Brand					Application
NTN	NSK	SKF	SNR	IRB	
		BAHB617546A		IR-8032	Fiat, Seat, Poleaventilador124
		BAHB445539	FC12025 S07 & S09, GB40570	IR-2220	Renault, Peugeot, Citroen, TRS
			FC12180	IR-2221	Renault, Peugeot, Citroen
			FC12271S03	IR-2222	Renault
		BAHB5000		IR-8520	Citroen
					Nissan
DE0565LZCS- 34PXX244	28BWD8A, 27KWD01			IR-8653	Nissan
	28BW03A, 28BWD08A		(GB615505)		SK10, Skoda 410
	28BWD01ACA60, 28BWD01A			IR-8549	Toyota Corolla Gtia92 1.6x16v8f
4T-CRI-0678	30KWD01AG3				
6-256706			HB-3080C/SBR		Fiat, Lada, Lancia, Seat, Volvo
	30BWD07	BA2B 633313C, BAHB405956A, BAHB418780	GB10790S05	IR-8040	Fiat, Lada, Lancia, Seat, Volvo
DE0776CS46	34BWD03ACA78				



Wheel Bearings

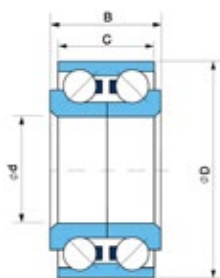

Principal dimensions				KG Bearing No.	Bearing No.	Mass		
d	D	B	C				kg	KOYO
mm								
32.00	70.00	38.00	38.00	WB3270-38	DAC32700038	0.62		
32.00	72.03	45.00	45.00	WB327203-45	DAC32720345	0.60		
34.00	62.00	37.00	37.00	WB3462-37	DAC34620037	0.41		531910, 561447
34.00	64.00	34.00	34.00	WB3464-34	DAC34640034	0.43	DAC3464D	
34.00	65.00	37.00	37.00	WB3464-37	DAC34640037	0.47	DAC3464G1	532066DE, 540466B
34.00	66.00	37.00	37.00	WB3466-37	DAC34660037	3.50		580400CA, 559529
35.00	61.80	40.00	40.00	WB35618-40	DAC35618040	0.43	DAC3562W-S, DAC3562W-5CS35	
35.00	65.00	37.00	37.00	WB3564-37	DAC35640037	0.46	DAC3564A-1	
35.00	65.00	35.00	35.00	WB3565-35	DAC35650035	0.40	DAC35WCS30	546238A
35.00	66.00	32.00	32.00	WB3566-32	DAC35660032	0.42		

Equivalent Bearing No. In Other Brand					Application
NTN	NSK	SKF	SNR	IRB	
	32BWD05CA75, 32BW07-7				
		BAHB311316B, BAHB309724		IR-8051	Audi, Volkswagen, Chrysler
DE0776CS4615A	34BWD03				Honda JAZZAA1.2 B4-86
DE07A39LL, 6-256907E1	34BWD04BCA70, 34BWD11	BAH0092, 309726DA	GB10884, HB-4022C/SBR	IR-8041	Lada, Opel, Volkswagen, Bedford
	34BWD10B	BAHB636114A, BAHB479399	HB-110487/SBR	IR-8622	Opel, Vauxhall, Accord, Corsa
AU0706-3					
DE0749, DE-0766LUA, AU0704-1LL		BAHB0042, BT2B445620B			TJ7300:Daihatsu
	(12438GB)	BT2B445620B, BAHB443952	GB12004, FC12033S03, GB12438S01	IR-8042	Renault, Chrysler
	35BWD14, 35BWD19E				Subaru



Wheel Bearings

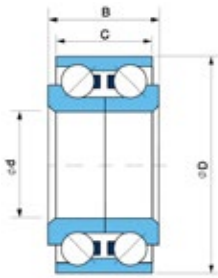

Principal dimensions				KG Bearing No.	Bearing No.	Mass		
d	D	B	C				kg	KOYO
mm								
35.00	66.00	33.00	33.00	WB3566-33	DAC35660033	0.43		
35.00	66.00	37.00	37.00	WB3566-37	DAC35660037	0.48		546238
35.00	68.00	37.00	37.00	WB3568-37	DAC35680037	0.52	DAC3568A2RS	546238, 544307
35.00	68.00	39.00	36.00	WB3568-39-36	DAC35680039/36	0.56		567918B, 541153A, 430042C
35.00	68.02	33.00	30.00	WB3568-33-30	DAC35680233/30	0.47	DAC3568W-6	
35.00	72.00	33.00	33.00	WB3572-33	DAC35720033	0.58	DAC357233B-W	
35.00	72.00	34.00	34.00	WB3572-34	DAC35720034	0.58	DAC357234A	548083
35.00	72.02	28.00	28.00	WB357202-28	DAC35720228	0.49		540763
35.00	72.02	33.00	31.00	WB3572-33-31	DAC35720233/31	0.54	DAC357233B-1W	544033
35.00	72.04	33.00	33.00	WB3572-334	DAC35720433	0.58	DAC3668WCS36	562686
35.00	72.04	34.00	34.00	WB357204-34	DAC35720434	0.58		
35.00	76.00	54.00	54.00	WB3576-54	DAC35760054	0.95		
36.00	68.00	33.00	33.00	WB3668-33	DAC36680033	0.47	DAC3668AWCS36	

Equivalent Bearing No. In Other Brand					Application
NTN	NSK	SKF	SNR	IRB	
		BAHB633676, BAHB-0015	GB12306S01	IR-8089	Fiat, TIPO 1.4
		BAHB311309, BAHB0023	GB12136	IR-8055	Volkswagen, Chrysler, Goif11, Polo, VW
		BAHB633528F, BAHB633295B, BAHB633976	GB10840S02	IR-8611, IR-8026	Fiat, Lancia, Seat, Volvo, Zastava, Chrysler
	35BWD16CA74				
					Nissan Micra 10
	35BWD06A	BA2B446762B, BA2B445535AE, BAH0013	GB12094S04, GB40582	IR-8055	Citroen, Peugeot
DE0763CS46PXI	35BWD064ACA38		DE0763CS46PXI		LZW7100, Honda Ci- vic1.2SF,1.5SG77.01
		BAHB441832AB	GB10679	IR-8028	Citroen, Peugeot, Renault, Simca, Talbot
	35BWD08A, 35BWD064ACA111				Toyota Tercel A120 13 82,- 4WDAL251
		BAHB633669, BAHB0013D	GB12862, GB40714	IR-8094	Fiat, Lancia, TIPO 1.6, Honda, Suzuki
			DE0763	IR-8524	Honda, TIPO 1.6
	35BWD10				
DE0784	35BWD04	BAHB0087			Suzuki Swift 10 86-89,1.3 84-89, GT11



Wheel Bearings

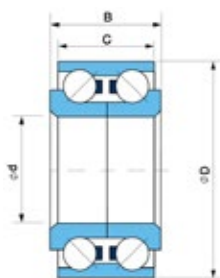

Principal dimensions				KG Bearing No.	Bearing No.	Mass		
d	D	B	C				kg	KOYO
mm								
36.00	72.00	33.00	28.00	WB3672-33-28	DAC36720033/28	0.50		805172
36.00	72.05	34.00	34.00	WB3672-34	DAC36720534	0.58	DAC367234A	
36.00	76.00	29.00	27.00	WB3676-29-27	DAC36760029/27	0.55		
37.00	72.00	33.00	33.00	WB3772-33	DAC37720033	0.51		
37.00	72.00	37.00	37.00	WB3772-37	DAC37720037	0.59		
37.00	72.02	37.00	37.00	WB377202-37	DAC37720237	0.59		
37.00	72.04	37.00	37.00	WB3772-437	DAC37720437	0.59		527631
35.00	74.00	45.00	45.00	WB3574-45	DAC37740045	0.79		562398A
38.00	70.00	37.00	37.00	WB3870-37	DAC38700037	0.56		541521C
38.00	70.00	38.00	38.00	WB3870-38	DAC38700038	0.57	DAC3870BW, DAC3870DWCS41	
37.99	71.02	33.00	30.00	WB37997102-33-30	DAC38710233/30	0.49	DAC3871W-1CS74, DAC3871W-2	686908A
38.00	72.00	34.00	34.00	WB3872-34	DAC38720034	0.54	DAC3872A	
38.00	72.00	40.00	40.00	WB3872-40	DAC38720040	0.63	DAC3872B12RSCS42,- DAC3872W	
38.00	72.02	36.00	33.00	WB387202-36-33	DAC38720236/33	0.56	DAC3872W-6, DAC38728CS81	575069

Equivalent Bearing No. In Other Brand					Application
NTN	NSK	SKF	SNR	IRB	
DE0769	36BW01BCA60			IR-8005	Chrysler, Honda
6-256908			GB12807 S03, GB40706	IR-8066	Fiat, Ford, Lancia, Renault19-21, Chrysler
		BA2B633028CB	GB12258	IR-8048	Chrysler
		BAHB633531, BAHBC0012, BAH0094	GB12131S03	IR-8088	Alfa Romeo, Fiat, Lancia, Chrysler, Renault
	37BWD01	BA2B309946AC, 309946AC 2RS	GB12095S01	IR-8513, IR-8049	BMW, Opel, Ford
	38BWD19	BAHB636193C	GB13870S01		Santro-FW
	38BWD21CA53	BAHB686908A			7100 Charade TJ7100
90369-38006	38BWD09A				
DE0769CS46P	38BWD04CA60				
DE0871	38BW07-10				Honda 44300-SB3-961/2
	38BWD12CA145				Honda, Rover, Toyota 90363- 30010/11



Wheel Bearings

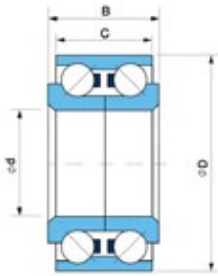

Principal dimensions				KG Bearing No.	Bearing No.	Mass		
d	D	B	C				kg	KOYO
mm								
38.00	73.00	40.00	40.00	WB3873-40	DAC38730040	0.67	DAC3873W3	
38.00	74.00	36.00	33.00	WB3874-36-33	DAC38740036/33	0.61		574795A
38.00	74.00	50.00	50.00	WB3874-50	DAC38740050	0.85	DAC3874368W	559192
38.00	74.00	36.00	33.00	WB3874-36-33	DAC38740236/33	0.59		574795A
38.00	74.04	50.00	50.00	WB387404-50	DAC38740450	0.85	DAC3874W-6CS84	
39.00 (41.00)	75.00	37.00	37.00	WB39(41)75-37	DAC39(41)750037	0.62		567447B, 539166AB, 523854
39.00	68.00	37.00	37.00	WB3968-37	DAC39680037	0.48		540733, 528810, 439622C
39.00	68.06	37.00	37.00	WB396806-37	DAC39680637	0.48		540733C
39.00	68.07	37.00	37.00	WB396807-37	DAC39680737	0.48		
39.00	72.00	37.00	37.00	WB3972-37	DAC39720037	0.60		542186A
39.00	72.06	37.00	37.00	WB397206-37	DAC39720637	0.60	DAC3972AW4	542186CA
39.00	74.00	39.00	39.00	WB3974-39	DAC39740039	0.66		579557
40.00	108.00	32.00	17.00	WB40108-32-17	DAC401080032/17	1.04		
40.00	72.00	36.00	33.00	WB4072-36-33	DAC40720036/33	0.67		
40.00	72.00	37.00	37.00	WB4072-37	DAC40720037	0.55	DAC4072CS34	566719, 455608

Equivalent Bearing No. In Other Brand					Application
NTN	NSK	SKF	SNR	IRB	
	38BV07-20G, 38BVVD26E				
DE08A48	38BV07/NACHI, 38BWD15			IR-8550	Honda Fit 1.3,1.5,1.6
	38BWD06		DE0874		Toyota Celica 4WD2.0IT 16V ST18590
DE0892, DE0874	38BWD01A1A- CA147, 38BWD15, 38BV07-26G	BAH-0041		IR-8651	Nissan
				IR-8550	Toyota
DE0892		BAHB633815A	GB12399 S01		Nissan, Chrysler
	39BWD02, 39BW- D03CA69	BA2B309692, BA2B309396, BAHB309791		IR-8530	AUDI
4T-CRI- 0868,DE0810		BAHB311315AD		IR- 8052,IR-8111	Ford, Audi, Sonata, Mazda 626, Passat
					Volkswagen
	39BWD01C	BAHB309639, BAHB311396B, BAHB0036A	GB12776		Volkswagen, Ford, Bedford, Vaux- hall, Monza
TU0811				IR-8085	BMW, Opel, Ford, Bedford, Vauxhall, Monza
		BAHB636096A	GB40037		BMW, Opel, Ford, Bedford, Vauxhall, Monza
		BA2B445533	TGB10872S02	IR-8603	Opel, Vauxhall
				IR-8048	Renault 18GTX
		BAHB311443B	GB12320 S02		



Wheel Bearings

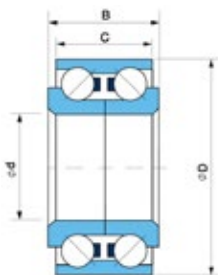

Principal dimensions				KG Bearing No.	Bearing No.	Mass		
d	D	B	C				kg	KOYO
mm								
40.00	72.06	37.00	37.00	WB407206-37	DAC40720637	0.55		
40.00	74.00	36.00	36.00	WB4074-36	DAC40740036	0.62		
40.00	74.00	36.00	34.00	WB4074-36-34	DAC40740036-34	0.58		
40.00	74.00	40.00	40.00	WB4074-40	DAC40740040	0.67		559493
40.00	74.00	42.00	42.00	WB4074-42	DAC40740042	0.70	DAC407440	
40.00	75.00	37.00	37.00	WB4075-37	DAC40750037	0.62	DAC4074W-3	559494
40.00	76.00	33.00	33.00	WB4076-33	DAC40760033	0.52		55580, 539166
40.00	76.00	33.00	28.00	WB4076-33-28	DAC40760033/28	0.54		539166AB
40.00	76.00	41.00	38.00	WB4076-41-38	DAC40760041/38	0.69		559226
40.00	76.04	41.00	38.00	WB407604-41-38	DAC40760441/38	0.69	DAC407641 2RS	
40.00	80.00	30.20	30.20	WB4080-302	DAC408000302	0.64		523854
40.00	80.00	31.00	31.00	WB4080-31	DAC40800031	0.65		
40.00	80.00	36.00	34.00	WB4080-36-34	DAC40800036/34	0.74		
40.00	82.00	40.00	40.00	WB4082-40	DAC40820040	-	DAC4080MICS68M	
40.00	82.02	53.80	53.80	WB408202-538	DAC408402538	0.97		
41.00	68.00	40.00	35.00	WB4168-40-35	DAC41680040/35	-		
42.00	76.00	39.00	39.00	WB4276-39	DAC425760039	0.62		
42.00	72.00	38.00	38.00	WB4272-38	DAC42720038	0.54		

Equivalent Bearing No. In Other Brand					Application
NTN	NSK	SKF	SNR	IRB	
				IR-8095	Volkswagen, Seat, Golf111-Vento, Swift 1.6
	40BWD15A				
AU0817-1					
	40BWD06B	BAHB636060C			Proton
DE08A27	40BWD12CA88			IR-8668	Mazda, Allegra
		BAHB633966E, BAH0086			
	40BWD08AC55			IR-8593	Ford, Audi 100
		BAHB474743			
	40BWD05			IR-8110	Chrysler, Volkswagen, Rover
DE0891				IR-8583	Honda, Rover
		BAHB440320	Y44FB10394 S01		
		BA2B445469BA	GB12088S01	IR-8006	Peugeot, Simca, Talbot, Volvo
	40BWD07A	BAHB636187		IR-8062	Alfa, Romeo, Citroen, Peugeot
					GM, Mitsubishi
			GB40250		Citroen
				IR-8638	Renault
					Chrysler, Opel, VM
4T-CRI-0822	42KWD02	BAH1866047A			Mazda 626-2WD (GD) 89-90



Wheel Bearings

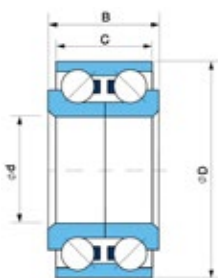

Principal dimensions				KG Bearing No.	Bearing No.	Mass		
d	D	B	C				kg	KOYO
mm								
42.00	75.00	37.00	37.00	WB4275-37	DAC42750037	0.60	DAC4275BW 2RS	533953, 545495D, 521771
42.00	76.00	38.00	35.00	WB4276-38-35	DAC42760038/35	0.65		
42.00	76.00	40.00	37.00	WB4276-40-37	DAC42760040/37	0.66	DAC427640 2RSF	547059A
42.00	78.00	41.00	38.00	WB4278-41-38	DAC42780041/38	0.75	DAC4278C2RS	
42.00	78.00	45.00	45.00	WB4278-45	DAC42780045	-		
42.00	78.05	41.00	38.00	WB427805-41-38	DAC42780541/38	-		
42.00	80.00	36.00	34.00	WB4280-36-34	DAC42800036/34	0.81		
42.00	80.00	37.00	37.00	WB4280-37	DAC42800037	0.68		
42.00	80.00	42.00	42.00	WB4280-42	DAC42800042	0.82		582226
42.00	80.00	45.00	45.00	WB4280-45	DAC42800045	0.86	DAC428045BW, DAC4280W-2CS40	
42.00	80.03	42.00	42.00	WB428003-42	DAC42800342	0.82	DCSAC4280B 2RS	52721B, 582226, 527243C
42.00	82.00	36.00	36.00	WB4282-36	DAC42820036	0.77	DAC4282	561481, 588226
42.00	82.00	37.00	37.00	WB4282-37	DAC42820037	0.79		565636
42.00	84.00	34.00	34.00	WB4284-34	DAC42840034			
42.00	84.00	36.00	36.00	WB4284-36	DAC42840036	0.84		564727
42.00	84.00	39.00	39.00	WB4284-39	DAC42840039	0.93		543359B

Equivalent Bearing No. In Other Brand					Application
NTN	NSK	SKF	SNR	IRB	
		BA2B 633457, BA-HB311424A, BAHB309245	GB12010	IR-8061, IR-8509	Alfa Romeo, Audi100-200, Porsche, BMW
TM-DU08A21	42BWD06CS98	BAHB603694A, BAHB633196, BAHB633791		IR-8650	Nissan
				IR-8112	Chrysler
DE0829CS32		BA2B309796BA, BAHB909042			Honda Civic EE9, CR-XEE81.6116 V DOHC
		BAH-0069			
	42BWD08		GB12955 S04	IR-8502	Alfa Romeo
DE08A-30LLCS67PX2		BAHB633770, BAH0004-A			VM Transporter Syncro 4X4 84-92
	42BWD11	BAHB309609			Mazda
		BAH-0028		IR-8515	BMW, Chrysler
		BA2B305988, BA2B309609	GB12163 S04, GB12875	IR-8086, IR-8642	Citroen, GM, Puegeot 306-405
		BA2B446047, BAHB446097, GB40574	GB12269	IR-8090	Audi 100-200 Avant Quattro
		BAHB311413A		IR-8012	
		BAHB440667	GB10857 S02	IR-8039	Puegeot, Simca, Talbot
		BA2B444090AB	GB10702 S02	IR-8101	Renault, Puegeot



Wheel Bearings

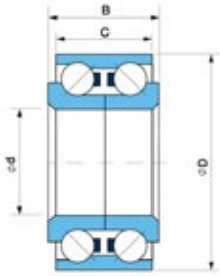

Principal dimensions				KG Bearing No.	Bearing No.	Mass		
d	D	B	C				kg	KOYO
mm								
42.00	84.02	36.00	36.00	WB428402-36	DAC42840236	0.84		
43.00 (45.00)	82.00	37.00	37.00	WB43(45)82-37	DAC43(45)820037	0.76		567519A, 800941C
43.00	79.00	41.00	38.00	WB4379-41-38	DAC43790041/38	0.77	DAC4379W-1CS57, DAC4379W2CS94	
43.00	80.00	38.00	38.00	WB4380-38	DAC43800038	0.75		579943B
43.00	80.00	50.00	45.00	WB4380-50-45	DAC43800050/45	0.91	DAC4380A, DA- C4380ACS69	
43.00	82.00	45.00	45.00	WB4382-45	DAC43820045	0.96	DAC4382W-3CS79	
44.00	82.50	37.00	37.00	WB44825.37	DAC44825037	0.73		
45.00	80.00	45.00	45.00	WB4580-45	DAC45800045	0.78		564725AB
45.00	84.00	39.00	39.00	WB4584-39	DAC45840039	0.85	DAC458439BW, DAC4584DWCS76	547103E
45.00	84.00	42.00	40.00	WB4584-42-40	DAC45840042/40	0.94		
45.00	85.00	23.00	23.00	WB4585-23	DAC45850023	0.54		4209BTVH
45.00	85.00	30.20	30.20	WB4585-302	DAC458500302	0.63		
45.00	85.00	41.00	41.00	WB4585-41	DAC45850041	0.89		580191, 578413A
48.00	89.00	42.00	42.00	WB4889-42	DAC48890044/42	1.07	DAC4889WS	
49.00	88.00	46.00	46.00	WB4988-46	DAC49880046	1.05		572506E
50.00	90.00	34.00	34.00	WB5090-34	DAC50900034	-		528514
50.00	90.00	35.00	35.00	WB5090-35	DAC50900035	-		

Equivalent Bearing No. In Other Brand					Application
NTN	NSK	SKF	SNR	IRB	
		BAHB440090			
				IR-8506	Audi 200
	43BWD08	BAHB633814A, BAH- B0011A			Honda Civic EG6/EH9
				IR-8667	Ford, Fiat, Volkswagen
	43BWD03				Toyota Supra 3.1124V 86-3.0
	43BWD06				Toyota Camry 2.21, 3.01 91-
			GB40246	IR-8618	Citroen, Peugeot
	45BWD06				
		BAHB311363	GB40264S01, GB12398S02	IR-8572, IR-8529	Citroen, Mercedes, Peugeot
B-DE0994, AU-0901-4LX1	45BWD07B	BAHB309797C, BA- HB636149D			Mitsubishi
4209ATN9, MT33VB2669			GB12865S04	IR-8566	Ford, Citroen, Fiat
		420ATN/9, MT33VB2669		IR-8597	Ford
	48BWD01				Ford, BMW
	49BWD01B	BAHB633960			
					Lexus GS300, GS400 JZS 160/UZS 1, BENZ
		BAHB633007C			



Clutch Bearings

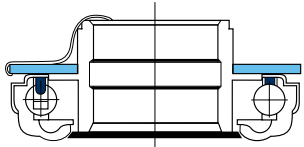

Diagram of a typical Clutch Bearing

KG Bearing No.	Oem No.	Equivalent Bearing No. In Other Brand				Application
		KOYO	NSK	NTN	NACHI	
	NBN-40-B			TK40-1B		Datsun
					BC12S11	
	0222-16-222/ MD702241	RCT45-1S	45TKD02	SF0914	45TMK-1	Mazda, Mitsubishi
	90363-33001	RCT3360L1	TK33-1U3	SF0724/2E	BC7S1SB	Toyota
	0727-16-512A		TK55-1BU3			Mazda
		RCT401SA	54TKA3501			
CB38668-316			50TKA3805			
		CT24AG				
CB35250-408	31230-35070		50SCRN40			Toyota
CB354233	31230-35090		50TKB3504BR			Toyota
CB3366-70	31230-12170			50TKB3301BR	50SCRN31P	Toyota
	31230-12170				50SCRN31P-1	Toyota
CB285728		RCT282SA	44TKB2805			Charade
				FCR55-17-9		
				FCR55-17-11		
			FCR54-48-3/2E			
CB3377-395		RCT331SA		FCR50-10/2E		
	22810-P20-005		47TKB3101			Honda
			47TKB3102			Honda
CB3572-41		CBU553524B				Honda
CB3155-351	22810-PL8-921	RCTS31SA	55TKA3102	X10-FCR55-5/2E		Honda
CB31870-335	MD706180	RCT322SA	48TKA3201	FCR45-11/2E	48SCRN32K	Mitsubishi
	ME602710	RCT47SA1	58TKA3703			Mitsubishi
	8-94101-243-0		48TKA3214			Chev LUV

Clutch Bearings

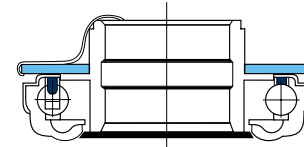
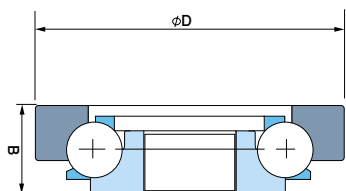

Diagram of a typical Clutch Bearing

KG Bearing No.	Oem No.	Equivalent Bearing No. In Other Brand				Application
		KOYO	NSK	NTN	NACHI	
	9-0095-040-1	RCT38SL1	24TK308B	SF0816	BC12S4	Isuzu
CB3557-13	90043-63002	CT35S	35TMK29B		35TRK-1	Mitsubishi
CB40636-16	90363-40003	RCT4064SL1	TK40-14AU3	SF0815	40TRK39-4SB	Toyota
CB4067-20	90363-40022	RCT4067A2RS	40TKD07	SF0859	40TRBC07-27SB	Toyota
		TCT40	TK40-16AU3	SF0845	TOTRK30W2SB	Toyota
			48TKA3214		RCT37SA7	Isuzu
		RCT338SA1	50TKE3301			
		RCT45-1S	TK40-4B	SF0914		Isuzu
CB407519		RCT4075-1S	TK40-4A	SF0820	40TRK1	Nissan
	30502-21000	RCT3360A	33TKD03/ TK33-Z1	SF0743	BC7S1W2SB	Toyota
CB5588-196	90363-3302	CT55BL1		55TMK804X	55TMK804	Isuzu
CB70117-27		CT70B	TK70-1A	SF1412	70TNK-1	Hino, Mitsubishi
CB45736-18	345221003	CT45-1S	TK45-4	45TMK804X	40TNK804	Nissan, Mazda
	90363-4009	CT52A-1	TK52Z-1BA	52TMK804	BC11S3	
		RCT45-4S	45TKD02	SF0914	45TMK-1	
					052TRBC09-7	Toyota



Steering Bearings



KG Bearing No.	Equivalent No.	Dimensions	
		D	B
		mm	
SB3811	VBT17Z-2	38.00	11.00
SB4011	VBT17Z-4	40.00	11.00
SB41115	VTAA19Z-1	41.00	11.50
SB4112	VTAA19Z-4	41.00	12.00
SB4011 A	ACS0304	40.00	11.00
SB43125	ACS040412	43.00	12.50
SB3879	128802	38.00	7.90
SB4213	17VBSW02	42.00	13.00
SB3511	15BCS02	35.00	11.00
SB4713	BT-19Z-LA	47.00	13.00
SB5214	20BSW01	52.00	14.00
SB44135	VBT20Z-1	44.00	13.50
SB47135	ACS0405J-2	47.00	13.50
SB4711	ACS0405J-4	47.00	11.00
SB4011 B	VBT17Z-3	40.00	11.00

Air conditioner Bearings

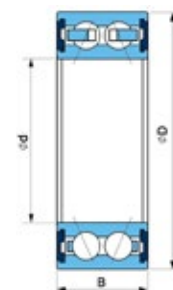

KG Bearing No.	Equivalent No.	Dimensions		
		d	D	B
		mm		
ACB3047-18	30BG4S8G	30.00	47.00	18.00
ACB3047-22	30BG4S13	30.00	47.00	22.00
ACB3052-22	30BD5222DUMS	30.00	52.00	22.00
ACB3055-23	30BG05SSDS	30.00	55.00	23.00
ACB3062-27	30BGS1	30.00	62.00	27.00
ACB3257-18	32BG4718BU	32.00	57.00	18.00
ACB3255-23	32BG05S1DSE	32.00	55.00	23.00
ACB3550-20	35BGS05S7G	35.00	50.00	20.00
ACB3552-23	35BG05S6G	35.00	52.00	23.00
ACB3555-20	DAC3555RD3H/35BD219DU	35.00	55.00	20.00
ACB3562-21	35BG06GDS	35.00	62.00	21.00
ACB3854-17	35BG05S6G	38.00	54.00	17.00
ACB4055-24	40BGS40G	40.00	55.00	24.00
ACB4057-24	40BG05S1G	40.00	57.00	24.00
ACB4057-24 A	40BD219V/DF0882LB	40.00	57.00	24.00
ACB4062-20625	907257A/40 BD 49V	40.00	62.00	20.63
ACB4062-24	40BGS12G	40.00	62.00	24.00
ACB4062-24 A	40BD219DU	40.00	62.00	24.00
ACB4066-24	40BGS39G	40.00	66.00	24.00
ACB4068-30	40BD6830DUK	40.00	68.00	30.00



Hub Units

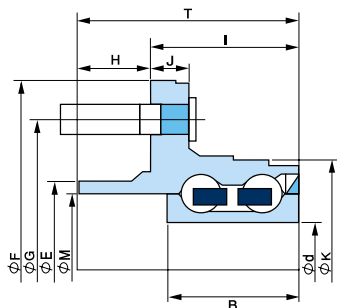

Diagram of a typical Hub Unit

KG Bearing No.	Bearing No.	Principal dimensions				
		d	F	B	T	E
		mm				
2HUB25108-734	DACF1035B	25.00	133.00	43.00	73.40	60.00
2HUB25100-734	DACF1029	25.00	133.00	43.00	73.40	60.00
2HUB271143-73	DACF1082C	27.00	148.00	55.00	73.00	66.00
2HUB2897-42	DACF1076D	28.00	-	42.00	-	-
2HUB281143-645	DACF1112A	28.00	139.00	38.00	64.50	67.00
2HUB281143-705	DACF1050A	28.00	140.00	48.00	70.50	67.00
2HUB28100-71	DACF1050B	28.00	140.80	50.50	71.00	56.00
2HUB3099-42 A	DACF1072B-1	30.00	-	42.00	-	-
2HUB3098-613	DACF1083CR	30.00	117.00	37.00	61.30	58.00
2HUB30100-595	DACF1041C	30.00	122.00	47.00	59.50	54.00
2HUB30100-79	DACF1049A	30.00	126.00	59.00	79.00	56.00
2HUB30108-713	DACF1038A	30.00	131.00	43.00	71.30	65.00
2HUB30100-66 A	DACF1102A	30.00	136.00	41.00	66.00	56.00
2HUB30100-66	DACF1015	30.00	136.00	40.00	66.00	56.00
2HUB301143-705	DACF1086	30.00	140.00	50.00	70.50	67.00
2HUB30100-705	DACF1087A	30.00	125.00	50.00	70.50	56.00
2HUB301143-675	DACF1065A	30.00	152.00	41.00	67.50	64.00

Principal dimensions						Bolt Size	Outer Ring Flange	
M	G	K	H	I	J		Bolt Hole mm	Bolt (Q'ty)
mm								
54.25	108.00	71.00	19.40	54.00	12.25	M12*1.5	14,22	5
54.30	100.00	71.00	19.40	54.00	11.00	-	M12*1.5	4
52.00	114.30	64.00	15.50	57.50	9.00	-	12,5	4
61.00	97.00	66.20	-	51.80	7.50	-	10,5	4
58.00	114.30	70.00	14.00	50.50	9.00	-	14	4
59.00	114.30	63.00	14.00	50.50	9.00	M12*1.5	14	4
47.80	100.00	66.60	18.90	52.10	4.50	M12*1.5	14	4
63.00	99.00	68.20	-	51.80	7.50	-	10,5	4
52.00	98.00	71.80	17.00	44.30	10.00	M12*1.5	-	4
48.00	100.00	68.00	13.50	56.00	8.00	M12*1.5	12,56	4
50.50	100.00	65.50	14.50	62.50	10.00	M12*1.5	14	5
59.00	108.00	76.00	19.00	21.00	13.50	-	M12*1.5	4
51.00	100.00	68.50	11.50	54.50	8.00	-	12,1	4
51.00	100.00	68.50	11.50	54.50	8.00	M12*1.5	12,1	4
59.00	114.30	68.90	14.00	56.50	9.00	M12*1.5	14	4
50.00	100.00	68.90	14.00	56.50	10.00	M12*1.5	14	4
58.00	114.30	67.00	11.50	55.50	9.00	M12*1.5	12,1	4



Hub Units

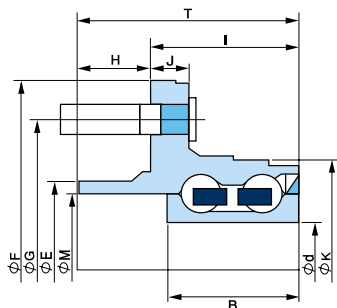

Diagram of a typical Hub Unit

KG Bearing No.	Bearing No.	Principal dimensions				
		d	F	B	T	E
		mm				
2HUB30999-42	DACF1022	30.00	-	42.00	-	-
2HUB3090-50	DACF1091A	30.00	-	50.00	-	66.00
2HUB3099-42	DACF1097D	30.00	-	42.00	-	-
2HUB311143-61	DACF1005C	31.00	120.00	40.00	61.00	57.00
2HUB331143-712	DACF1034C	33.00	140.00	47.00	71.20	67.00
2HUB341143-645	DACF1081C	34.00	139.00	42.00	64.50	67.00
2HUB34107-70	DACF1036A	34.00	139.50	42.00	70.00	64.00
2HUB34595-655	DACF1031B	34.50	139.00	52.00	65.50	63.26
2HUB35108-695	DACF1023D	35.00	137.00	45.00	69.50	65.00
2HUB35110-74	DACF1082L	35.00	137.00	45.00	74.00	65.00
2HUB361143-71	DACF1063A	36.00	140.00	50.00	71.00	67.00
2HUB37120-64	DACF1033K	37.00	139.00	45.00	64.00	72.50
2HUB37120-64 A	DACF1033K-1	37.00	139.00	45.00	64.00	72.50
2HUB37120-64 B	DACF1033K-2	37.00	139.00	45.00	64.00	72.50
2HUB381143-77	DACF1074CR	38.00	146.50	52.00	77.00	70.00
2HUB40106-43	DACF1092A	40.00	-	53.00	43.00	84.00

Principal dimensions						Bolt Size	Outer Ring Flange	
M	G	K	H	I	J		Bolt Hole mm	Bolt (Q'ty)
mm								
63.00	99.90	72.00	-	58.50	7.50	-	10,5	4
58.30	99.00	68.00	10.00	44.00	10.00	-	M12*1.5	4
63.00	100.00	73.60	-	51.80	7.50	-	10,5	4
50.50	114.30	73.80	19.00	42.00	12.00	-	M12*1.5	4
59.00	114.30	77.00	14.00	54.70	9.00	M12*1.5	14	5
58.00	114.30	74.00	14.00	50.50	9.00	M12*1.5	14	4
58.00	107.00	75.00	15.00	55.00	9.00	M12*1.5	12,1	4
58.00	95.00	86.00	13.50	52.00	10.00	M12*1.5	13,1	5
53.30	108.00	81.00	20.50	49.00	12.00	M12*1.5	13,1	5
57.00	110.00	81.00	25.00	49.00	12.00	-	M12*1.5	5
59.00	114.30	79.00	14.00	57.00	11.00	M12*1.5	14	5
66.00	120.00	84.00	19.00	45.00	11.00	-	M12*1.5	5
66.00	120.00	80.00	19.00	45.00	11.00	-	M12*1.5	5
66.00	120.00	80.00	19.00	45.00	11.00	-	M12*1.5	5
64.00	114.30	76.80	15.00	62.00	9.00	M12*1.5	12,1	5
-	106.00	84.00	16.40	26.50	10.00	-	M12*1.5	5



Hub Units

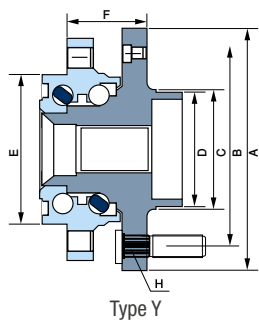
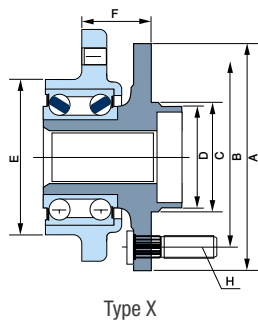

Hub Units

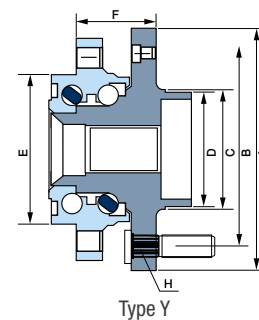
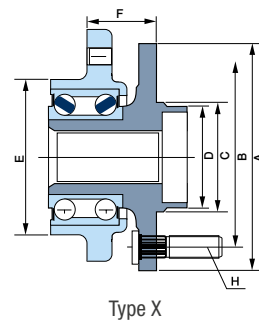

KG Bearing No.	Other Equivalent No.	Principal dimensions						Inner flange		Bearing Unit Model
		A	B	C	D	E	F	Bolt Hole Size (Q'ty)	Bolt Size (Q'ty)	
		mm						H		
3HUB65108-43	DAC2F01	135.50	108.00	68.00	65.00	83.50	43.00	M12x1.75 (-4)	-	Y
3HUB65108-43 A	DAC2F01-1	135.50	108.00	68.00	65.00	83.50	43.00	M12x1.75 (-5)	-	Y
3HUB65108-37	DAC2F02	130.50	108.00	68.00	65.00	81.00	37.00	M12x1.75 (-4)	-	Y
3HUB57100-44	DAC2F03	125.00	100.00	58.20	57.00	73.50	44.00	-	M12x1.5 (-5)	X
3HUB7131143-375	DAC2F04	140.00	114.30	73.30	71.30	86.40	37.50	-	M12x1.5 (-5)	Y
3HUB7014115-42	DAC2F05	147.00	115.00	70.60	70.14	90.00	42.00	-	M12x1.5 (-5)	Y
3HUB57100-444	DAC2F06	125.00	100.00	58.30	57.00	73.50	44.40	-	M12x1.5 (-5)	Y
3HUB71431143-542	DAC2F07	153.50	114.30	71.90	71.43	100.13	54.20	-	1/2-20UNF (-5)	X
3HUB568100-374	DAC2F08	127.20	100.00	60.80	56.80	87.00	37.40	-	M12x1.5 (-5)	X
3HUB74120-51	DAC2F09	139.00	120.00	79.00	74.00	90.00	51.00	M12x1.5 (-5)	-	Y
3HUB57112-70	DAC2F10	131.00	112.00	68.00	57.00	-	70.00	M14x1.5 (-5)	-	Y
3HUB65108-37	DAC2F11	130.50	108.00	68.00	65.00	83.00	37.00	M14x1.5 (-4)	-	Y

KG Bearing No.	Other Equivalent No.	Principal dimensions						Inner flange		Bearing Unit Model
		A	B	C	D	E	F	Bolt Hole Size (Q'ty)	Bolt Size (Q'ty)	
		mm						H		
3HUB65108-37 A	DAC2F12	130.50	108.00	68.00	65.00	83.00	37.00	M14x1.5 (-4)	-	Y
3HUB57100-4218	DAC2F13	125.00	100.00	55.77	57.00	71.00	42.18	-	M12x1.5 (-5)	X
3HUB701412065-4728	DAC2F14ABS	144.50	120.65	70.63	70.14	91.98	47.28	-	M12x1.5 (-5)	Y
3HUB601143-72	DAC2F16	152.00	114.30	62.00	60.00	79.30	72.00	-	M12x1.5 (-5)	Y
3HUB701412065-4728 A	DAC2F17	145.00	120.65	70.63	70.14	91.98	47.28	-	M12x1.5 (-5)	Y
3HUB701412065-4728 B	DAC2F17ABS	145.00	120.65	70.63	70.14	91.98	47.28	-	M12x1.5 (-5)	Y
3HUB565100-79	DAC2F18	135.50	100.00	57.00	56.50	60.00	79.00	M12x1.5 (-4)	M10x1.25 (-4)	Y



General Automotive and Agricultural Bearings

KG Bearing No.	Equivalent No.	Application	Mass
			Kg
K6207 2RS		Agricultural Machinery	0.288
612949/612910		Agricultural Machinery	1.100
W208 PP8	Koyo W208 PP8	Agricultural Machinery	0.700
W210 PP2	Koyo W210 PP2	Agricultural Machinery	0.720
DRT407232	SKF 407232D, KOYO 46T1011 ORC3	Bedford Pinion	3.120
2RNU0619	SKF 411919, KOYO 06NU0624	Bedford Pinion	0.327
30303D	NTN CR0357	Bedford Tractor Pinion	0.130
88509		Bedford Propeller Shaft	0.466
CB4067-20	NACHI 40TRBC07-27SB	Clutch Release-Toyota	0.280
35BCD08-2LR	NACHI 35BCD08S6CS, NSK B35 77C4	Clutch	0.250
C06		Collar	0.090
C014		Collar	0.170
CB3557-13	Nachi 35TRK-1	Clutch release - Mitsubishi	0.100
CT1310	URB 76Z12	Massey Ferguson Clutch	0.636
CT1310 2RS		Clutch release	0.636
28TAG12		Mitsubishi Clutch	0.125
98205		Crank Shaft	0.186
98305	SKF 1838001 C3	Crank Shaft	0.188
19341	FLT 68341	Gear Box	0.200
62/22		Gear Box	0.120
62/28		Gear Box	0.175
63/28		Gear Box	0.287
63/28 Z		Gear Box	0.287
63/32 N R		Gear Box	0.382
16006		Autorickshaw Gear Box	0.084
RMS 8		Bedford Gear Box	0.258

General Automotive Bearings

KG Bearing No.	Equivalent No.	Application	Mass
			Kg
RMS 9		Bedford Gear Box	0.390
33889/33821		Mercedes Truck Gear Box	0.876
512533		Mercedes Truck Gear Box	0.334
JC 8002	FLT CBK 239	Massey Bevel Pinion Pilot	0.274
JC 8003	FLT CBK 238	Massey Bevel Pinion Pilot	0.258
AC 10059		Peugeot Car Wheel	0.150
411280		Peykan Wheel	0.476
33275/33472		Tractor Rear Wheel	1.347
395A/394A	FLT CBK 336	Tractor Wheel	0.791
P2040		Water Pump	0.528
P2047-01		Water Pump	0.750
885158		Water Pump	0.300
FPS 14		Water Pump	0.298
32213UX1	FLT 515-769	Wheel	1.480
2580/20		Wheel	0.400
938/932		Wheel	10.100
88506		Wheel	0.280
88507		Wheel	0.355
3490/20	FLT 515-809	Wheel	0.683
3984/20	FLT CBK 337	Wheel	1.168
256907	ZKL PLC-14-24	Wheel	0.438
88512		Wheel	0.994



General Automotive Bearings

KG Bearing No.	Equivalent No.	Application	Mass
			Kg
CR-1252	NTN CR-1252 L	Wheel	0.686
639213		Fiat Wheel	0.094
639174		Fiat Wheel	0.136
639175		Fiat Wheel	0.148
500636	Timken TI 77	King Pin	0.320
532792	Timken TI 19	King Pin	0.150
532796	Timken T126	King Pin	0.140
532803	Timken T144	King Pin	0.290
532805	Timken TI 38	King Pin	0.300
EB 6210 WG	Nachi 30B60	Engine - Honda	0.214
509043 P		Steering	0.150
3982X/3927SX	KOYO 57239	Bedford Differential Side	1.148
594/592A			2.510
323/42AR			1.480
37425/37625	FLT CBK 339		1.370

General Automotive Bearings

KG Bearing No.	Equivalent No.	Application	Mass
			Kg
807813A			1.108
7909AA			1.575
102605M			0.360
30310D			1.220
285216	NSK TF28KW02g5SA; KBC TR285216g		0.152
KG38KW01 CG5	NSK TF38KW01 Cg5, KBC 38KW01 Cg5		0.252
6304NR			0.148
392/3920			0.900
801346-22/10-22			0.752
804358			2.556
BT25-4			0.229
QJ209 M	QJ209 M		0.520
QJ309 M	QJ309 M		1.050



Water Pump Bearings

Bearing number	Equivalent Bearing number
885117	WPBB1591830-1619
885141	WPBB1591830-12779
885158	WPBB1591830-1381
885166-3A	WPBB1230-128(S)
885786	WPBB15918381119
885802 B	WPBB15918381146
885865	WPBB15918381-1529
BWF35-3BR	WPBB1335-11875
BWF35-9QR	WPBR1235-110
BWF40-17R	WPBR1340-119
BWF40-19R	WPBB1240-111
FPS14	FPS14-2RS
P2040	P2040
P2047-01	WPBB2047-143
RWF35-3E-Q	WPBR1235-114
W22R119J	WPBR1242-119(16)
W6B102A	WPBB1267530-1025(15918)
WB1630116	WPBB1230-116(15918)
WIB2552150	WPBB1652-150
WIR1226103	WPBB1226-1035
WIR2242116	WPBR1342-116
WPBB1230106 D	WPBB1230106D
WPBB13381-112	WPBB13381
WPBB1630082-1	WPBB1630082-1
WPBR1242-119	WPBR1242-119(22)
WPBR1630139	WPBR1630139
WR2555127	WPBR160555-127
WR2555127-1505	WPBR150555-127
K105	K105
WB1630128-1	WPBB1230-128
WR2555127-1505	WR2555127-1505
WPBB2242140	WPBB2242-140
WPBR2242111	WPBR2242-111
W40-112	WPBB13381-112
885166K	WPBB1593930-1278(S)
WPB1630103	WPBB1630-103
FPS18	FPS18
FPS104	FPS104
FPS100	FPS100
FPS582	FPS582
FPS348	FPS348



Tensioner Bearings

Bearing number	Equivalent Bearing number
0069A	TB10285-40
25405173	TB1060-28
60TB039B09	TB760-425
60TB041B02	TB8560-195
60TB041B12	TB60-35
62TB0104	TB1262-286
JPU52-128JF434	TB52-315
JPU57-54+JF598	TB294575-39
PU245339ARR1DV	TB53-435
PU255037RR1DV	TB22550-42
PU408222RR9	TB3062-46
TPU006H	TB1250-272
99000360	TB2860-375



Alternator Bearings

Bearing number	Equivalent Bearing number
12BC04S3C4	ALB1242-10
317	ALB1532-11
319	ALB1543-13
338	ALB1547-14
348	ALB1538-19
382	ALB1552-16
437	ALB1752-16
B10-50DD	ALB1027-11
B17-99DWB PQ57	ALB1752-17PQ57
B8-85T1DDPQ59	ALB0823-14
B17-99DWB	ALB1752-17



UV Joints Bearings (Cross Bearings)

Bearing number
UVJA22X55 (S)
UVJA2384X612
UVJA27X70(S)
UVJA27X75(S)
UVJA27X817
UVJA29X80(S)
UVJA302X80(S)
UVJA302X92(S)
UVJA30X75(S)
UVJA30X91
UVJA32X76(S)
UVJA35X1065(S)
UVJA35X98(S)
UVJB30X85(S)
UVJB34X90(S)

Other types UV joints as per customer requirements



Agri Hub Bearings

Kg Agri Hub Part Nos.	Equivalent To	No. Holes	Principal dimensions				
			D	d1	J	A	B
			mm (inch)				
AH-0001	BAA-0001	4	117	28	98	60	105
AH-0002	BAA-0002	4	46.063	11.024	38.583	23.622	41.338
AH-0003	BAA-0003	4	117	28	98	60	-
AH-0004	BAA-0004	4	117	28	98	60	105
AH-0005	BAA-0005	4	117	28	98	60	105
AH-0006	BAA-0006	6	117	28	98	60	105
AH-0012	BAA-0012	5	117	28	98	60	105
AH-0013	BAA-0013	6	117	28	98	60	105

Principal dimensions				Basic Load Rating	
E	G1	G	H	C Dynamic	C1 Dynamic
mm (inch)				kN (lbf)	kN(lbf)
17	M12x 1.25	M22x 1.50	2.5	44.9	34 *
0.6693	1/2"-20	7/8"-14	0.0906	10 100	7 640 **
-	M12x 1.25	-	2.5	47.7	37.5 ***
17	M12x 1.25	M22x 1.50	2.5	47.7	37.5
17	M12x 1.25	M24x 1.50	2.5	47.7	37.5
17	M12x 1.25	M22x 1.50	2.5	47.7	37.5
17	M12x 1.25	M22x 1.50	2.5	47.7	37.5
17	M12x 1.25	M24x 1.50	2.5	47.7	37.5

* In Metric Series ** Imperial Series *** Without shaft

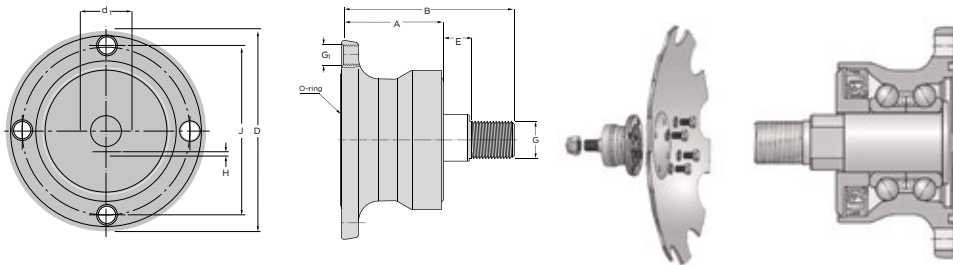

Appendix

Table 1 Inch-mm Conversion Table

Inch		0"	1"	2"	3"	4"	5"	6"	7"	8"
Fractions	Decimals									
0	0.000000	0.0000	25.4000	50.8000	76.2000	101.6000	127.0000	152.4000	177.8000	203.2000
1/64	0.015625	0.3969	25.7969	51.1969	76.5969	101.9969	127.3969	152.7969	178.1969	203.5969
1/32	0.031250	0.7938	26.1938	51.5938	76.9938	102.3938	127.7938	153.1938	178.5938	203.9938
3/64	0.046875	1.1906	26.5906	51.9906	77.3906	102.7906	128.1906	153.5906	178.9906	204.3906
1/16	0.062500	1.5875	26.9875	52.3875	77.7875	103.1875	128.5875	153.9875	179.3875	204.7875
5/64	0.078125	1.9844	27.3844	52.7844	78.1844	103.5844	128.9844	154.3844	179.7844	205.1844
3/32	0.093750	2.3812	27.7812	53.1812	78.5812	103.9812	129.3812	154.7812	180.1812	205.5812
7/64	0.109375	2.7781	28.1781	53.5781	78.9781	104.3781	129.7781	155.1781	180.5781	205.9781
1/8	0.125000	3.1750	28.5750	53.9750	79.3750	104.7750	130.1750	155.5750	180.9750	206.3750
9/64	0.140625	3.5719	28.9719	54.3719	79.7719	105.1719	130.5719	155.9719	181.3719	206.7719
5/32	0.156250	3.9688	29.3688	54.7688	80.1688	105.5688	130.9688	156.3688	181.7688	207.1688
11/64	0.171875	4.3656	29.7656	55.1656	80.5656	105.9656	131.3656	156.7656	182.1656	207.5656
3/16	0.187500	4.7625	30.1625	55.5625	80.9625	106.3625	131.7625	157.1625	182.5625	207.9625
13/64	0.203125	5.1594	30.5594	55.9594	81.3594	106.7594	132.1594	157.5594	182.9594	208.3594
7/32	0.218750	5.5562	30.9562	56.3562	81.7562	107.1562	132.5562	157.9562	183.3562	208.7562
15/64	0.234375	5.9531	31.3531	56.7531	82.1531	107.5531	132.9531	158.3531	183.7531	209.1531
1/4	0.250000	6.3500	31.7500	57.1500	82.5500	107.9500	133.3500	158.7500	184.1500	209.5500
17/64	0.265625	6.7469	32.1469	57.5469	82.9469	108.3469	133.7469	159.1469	184.5469	209.9469
9/32	0.281250	7.1438	32.5438	57.9438	83.3438	108.7438	134.1438	159.5438	184.9438	210.3438
19/64	0.296875	7.5406	32.9406	58.3406	83.7406	109.1406	134.5406	159.9406	185.3406	210.7406
5/16	0.312500	7.9375	33.3375	58.7375	84.1375	109.5375	134.9375	160.3375	185.7375	211.1375
21/64	0.328125	8.3344	33.7344	59.1344	84.5344	109.9344	135.3344	160.7344	186.1344	211.5344
11/32	0.343750	8.7312	34.1312	59.5312	84.9312	110.3312	135.7312	161.1312	186.5312	211.9312
23/64	0.359375	9.1281	34.5281	59.9281	85.3281	110.7281	136.1281	161.5281	186.9281	212.3281
3/8	0.375000	9.5250	34.9250	60.3250	85.7250	111.1250	136.5250	161.9250	187.3250	212.7250
25/64	0.390625	9.9219	35.3219	60.7219	86.1219	111.5219	136.9219	162.3219	187.7219	213.1219
13/32	0.406250	10.3188	35.7188	61.1188	86.5188	111.9188	137.3188	162.7188	188.1188	213.5188
27/64	0.421875	10.7156	36.1156	61.5156	86.9156	112.3156	137.7156	163.1156	188.5156	213.9156
7/16	0.437500	11.1125	36.5125	61.9125	87.3125	112.7125	138.1125	163.5125	188.9125	214.3125
29/64	0.453125	11.5094	36.9094	62.3094	87.7094	113.1094	138.5094	163.9094	189.3094	214.7094
15/32	0.468750	11.9062	37.3062	62.7062	88.1062	113.5062	138.9062	164.3062	189.7062	215.1062
31/64	0.484375	12.3031	37.7031	83.1031	88.5031	113.9031	139.3031	164.7031	190.1031	215.5031

Table 1 Inch-mm Conversion Table

Inch		0"	1"	2"	3"	4"	5"	6"	7"	8"
Fractions	Decimals									
1/2	0.500000	12.7000	38.1000	63.5000	88.9000	114.3000	139.7000	165.1000	100.5000	215.9000
33/64	0.515625	13.0969	38.4969	63.8969	89.2969	114.6969	140.0969	165.4969	100.8969	216.2669
17/32	0.531250	13.4938	38.8938	64.2938	89.6938	115.0938	140.4938	165.8938	191.2938	216.6938
35/64	0.546875	13.8906	39.2906	64.6906	90.0906	115.4906	140.8906	188.2906	191.6906	217.0906
9/16	0.562500	14.2875	39.6875	65.0875	90.4875	115.8875	141.2875	166.6875	192.0875	217.4875
37/64	0.578125	14.6844	40.0844	65.4844	90.8844	116.2844	141.6844	167.0844	192.4644	217.8844
19/32	0.593750	15.0812	40.4812	65.8812	91.2812	116.6812	142.0812	167.4812	192.8812	218.2812
39/64	0.609375	15.4781	40.8781	66.2781	91.6781	117.0781	142.4781	167.8781	193.2781	218.6781
5/8	0.625000	15.8750	41.2750	66.6750	92.0750	117.4750	142.8750	168.2750	193.6750	219.0750
41/64	0.640625	16.2719	41.6719	67.0719	92.4719	117.8719	143.2719	168.6719	194.0719	219.4719
21/32	0.656250	16.6688	42.0688	67.4688	92.8688	118.2688	143.6688	169.0688	194.4688	219.8688
43/64	0.671875	17.0656	42.4656	67.8656	93.2656	118.6656	144.0656	169.4656	194.8656	220.2656
11/16	0.687500	17.4625	42.8625	68.2625	93.6625	119.0625	144.4625	169.8625	195.2625	220.6625
45/64	0.703125	17.8594	43.2594	68.6594	94.0594	119.4594	144.8594	170.2594	195.6594	221.0594
23/32	0.718750	18.2562	43.6562	69.0562	94.4562	119.8562	145.2562	170.6562	196.0562	221.4562
47/64	0.734375	18.6531	44.0531	69.4531	94.8531	120.2531	145.6531	171.0531	196.4531	221.8531
3/4	0.750000	19.0500	44.4500	69.8500	95.2500	120.6500	146.0500	171.4500	196.8500	222.2500
49/64	0.765625	19.4469	44.8469	70.2469	95.6469	121.0469	146.4469	171.8469	197.2469	222.6469
25/32	0.781250	19.8438	45.2438	70.6438	96.0438	121.4438	146.8438	172.2438	197.6438	223.0438
51/64	0.796875	20.2406	45.6406	71.0406	96.4406	121.8406	147.2406	172.6406	198.0406	223.4406
13/16	0.812500	20.6375	46.0375	71.4375	96.8375	122.2375	147.6375	173.0375	198.4375	223.8375
53/64	0.828125	21.0344	46.4344	71.8344	97.2344	122.6344	148.0344	173.4344	198.8344	224.2344
27/32	0.843750	21.4312	46.8312	72.2312	97.6312	123.0312	148.4312	173.8312	199.2312	224.6312
55/64	0.859375	21.8281	47.2281	72.6281	98.0281	123.4281	148.8281	174.2281	199.6281	225.0281
7/8	0.875000	22.2250	47.6250	73.0250	98.4250	123.8250	149.2250	174.6250	200.0250	225.4250
57/64	0.890625	22.6219	48.0219	73.4219	98.8219	124.2219	149.6219	175.0219	200.4219	225.8219
29/32	0.906250	23.0188	48.4188	73.8188	99.2188	124.6188	150.0188	175.4188	200.8188	226.2188
59/64	0.921875	23.4156	48.8156	74.2156	99.6156	125.0156	150.4156	175.8156	201.2156	226.6156
15/16	0.937500	23.8125	49.2125	74.6125	100.0125	125.4125	150.8125	176.2125	201.6125	227.0125
61/64	0.953125	24.2094	49.6094	75.0094	100.4094	125.8094	151.2094	176.6094	202.0094	227.4094
31/32	0.968750	24.6062	50.0062	75.4062	100.8062	126.2062	151.6062	177.0062	202.4062	227.8062
63/64	0.984375	25.0031	50.4031	75.8031	101.2031	126.6031	152.0031	177.4031	202.8031	228.2031

Table 2 Hardness Conversion Table Approximate Conversion for Rockwell C Scale of Steel

Rockwell C Scale	Vickers	Brinell		Rockwell		Shore
		Standard Ball	Tungsten Carbide Ball	A Scale (588.4N)	B Scale (980.7N)	
(1471N)	940	—	—	85.6	—	97
67	900	—	—	85.0	—	95
66	865	—	—	84.5	—	92
65	832	—	(739)	83.9	—	91
64	800	—	(722)	83.4	—	88
63	772	—	(705)	82.8	—	87
62	746	—	(688)	82.3	—	85
61	720	—	(670)	81.8	—	83
60	697	—	(654)	81.2	—	81
59	674	—	(634)	80.7	—	80
58	653	—	615	80.1	—	78
57	633	—	595	79.6	—	76
56	613	—	577	79.0	—	75
55	595	—	560	78.5	—	74
54	577	—	543	78.0	—	72
53	560	—	525	77.4	—	71
52	544	(500)	512	76.8	—	69
51	528	(487)	496	76.3	—	68
50	513	(475)	481	75.9	—	67
49	498	(464)	469	75.2	—	66
48	484	451	455	74.7	—	64
47	471	442	443	74.1	—	63
46	548	432	432	73.6	—	62
45	446	421	421	73.1	—	60
44	434	409	409	72.5	—	58
43	423	400	400	72.0	—	57
42	412	390	390	71.5	—	56
41	402	381	381	70.9	—	55
40	392	371	371	70.4	—	54
39	382	362	362	69.9	—	52
38	372	353	353	69.4	—	51
37	363	344	344	68.9	—	50
36	354	336	336	68.4	(109.0)	49
35	345	327	327	67.9	(108.5)	48
34	336	319	319	67.4	(108.0)	47
33	327	311	311	66.8	(107.5)	46
32	318	301	301	66.3	(107.0)	44
31	310	294	294	65.8	(106.0)	43
30	302	286	286	65.3	(105.5)	42
29	294	279	279	64.7	(104.5)	41
28	286	271	271	64.3	(104.0)	41
27	279	264	264	63.8	(103.0)	40
26	272	258	258	63.3	(102.5)	38
25	266	253	253	62.8	(101.5)	38
24	260	247	247	62.4	(101.0)	37
23	254	243	243	62.0	100.0	36
22	248	237	237	61.5	99.0	35
21	243	231	231	61.0	98.5	35
20	238	226	226	60.5	97.8	34
(18)	230	219	219	—	96.7	33
(16)	222	212	212	—	95.5	32
(14)	213	203	203	—	93.9	31
(12)	204	194	194	—	92.3	29
(10)	196	187	187	—	90.7	28
(8)	188	179	179	—	89.5	27
(6)	180	171	171	—	87.1	26
(4)	173	165	165	—	85.5	25
(2)	166	158	158	—	83.5	24
(0)	160	152	152	—	81.7	24

Table 3 kgf-N Conversion Table

kgf		N	kgf		N	kgf		N
0.1020	1	9.8066	3.4670	34	333.43	6.8321	67	657.05
0.2039	2	19.6130	3.5690	35	343.23	6.9341	68	666.85
0.3059	3	29.4200	3.6710	36	353.04	7.0361	69	676.66
0.4079	4	39.2270	3.7730	37	362.85	7.1380	70	686.47
0.5099	5	49.0330	3.8749	38	372.65	7.2400	71	696.27
0.6118	6	58.8400	3.9769	39	382.46	7.3420	72	706.08
0.7138	7	68.6470	4.0789	40	392.27	7.4440	73	715.89
0.8158	8	78.4530	4.1809	41	402.07	7.5459	74	725.69
0.9177	9	88.2600	4.2828	42	411.88	7.6479	75	735.50
1.0197	10	98.0660	4.3848	43	421.69	7.7499	76	745.31
1.1217	11	107.8700	4.4868	44	431.49	7.8518	77	755.11
1.2237	12	117.6800	4.5887	45	441.30	7.9538	78	764.92
1.3256	13	127.4900	4.6907	46	451.11	8.0558	79	774.73
1.4276	14	137.2900	4.7927	47	460.91	8.1578	80	784.53
1.5296	15	147.1000	4.8947	48	470.72	8.2597	81	794.34
1.6316	16	156.9100	4.9966	49	480.53	8.3617	82	804.15
1.7335	17	166.7100	5.0986	50	490.33	8.4637	83	813.95
1.8355	18	176.5200	5.2006	51	500.14	8.5656	84	823.76
1.9375	19	186.3300	5.3025	52	509.95	8.6676	85	833.57
2.0394	20	196.1300	5.4045	53	519.75	8.7696	86	843.37
2.1414	21	205.9400	5.5065	54	529.56	8.8716	87	853.18
2.2434	22	215.7500	5.6085	55	539.37	8.9735	88	862.99
2.3454	23	225.5500	5.7104	56	549.17	9.0755	89	872.79
2.4473	24	235.3600	5.8124	57	558.98	9.1775	90	882.60
2.5493	25	245.1700	5.9144	58	568.79	9.2795	91	892.41
2.6513	26	254.9700	6.0163	59	578.59	9.3814	92	902.21
2.7532	27	264.7800	6.1183	60	588.40	9.4834	93	912.02
2.8552	28	274.5900	6.2203	61	598.21	9.5854	94	921.83
2.9572	29	284.3900	6.3223	62	608.01	9.6873	95	931.63
3.0592	30	294.2000	6.4242	63	617.82	9.7893	96	941.44
3.1611	31	304.0100	6.5262	64	627.63	9.8913	97	951.25
3.2631	32	313.8100	6.6282	65	637.43	9.9933	98	961.05
3.3651	33	323.6200	6.7302	66	647.24	10.0952	99	970.86

How to convert:

- To convert 10kgf into N, look for the number 10 on the central column of above table, the corresponding number in 'N' column is the converted value in Newtons.
- Likewise, 10N could be converted into kgf by referring to corresponding entry in kgf column.

Table 4 kgf-lb Conversion Table

kgf		lb	kgf		lb	kgf		lb
0.454	1	2.205	15.422	34	74.957	30.391	67	147.71
0.907	2	4.409	15.876	35	77.162	30.844	68	149.91
1.361	3	6.614	16.329	36	79.366	31.298	69	152.12
1.814	4	8.818	16.783	37	81.571	31.751	70	154.32
2.268	5	11.023	17.236	38	83.776	32.205	71	156.53
2.722	6	13.228	17.690	39	85.980	32.659	72	158.73
3.175	7	15.432	18.144	40	88.185	33.112	73	160.94
3.629	8	17.637	18.597	41	90.390	33.566	74	163.14
4.082	9	19.842	19.051	42	92.594	34.019	75	165.35
4.536	10	22.046	19.504	43	94.799	34.473	76	167.55
4.990	11	24.251	19.958	44	97.003	34.927	77	169.76
5.443	12	26.455	20.412	45	99.208	35.380	78	171.96
5.897	13	28.660	20.865	46	101.410	35.834	79	174.17
6.350	14	30.865	21.319	47	103.620	36.287	80	176.37
6.804	15	33.069	21.772	48	105.820	36.741	81	178.57
7.257	16	35.274	22.226	49	108.030	37.194	82	180.78
7.711	17	37.479	22.680	50	110.230	37.648	83	182.98
8.165	18	39.683	23.133	51	112.440	38.102	84	185.19
8.618	19	41.888	23.587	52	114.640	38.555	85	187.39
9.072	20	44.092	24.040	53	116.840	39.009	86	189.60
9.525	21	46.297	24.494	54	119.050	39.462	87	191.80
9.979	22	48.502	24.948	55	121.250	39.916	88	194.01
10.433	23	50.706	25.401	56	123.460	40.370	89	196.21
10.886	24	52.911	25.855	57	125.660	40.823	90	198.42
11.340	25	55.116	26.308	58	127.870	41.277	91	200.62
11.793	26	57.320	26.762	59	130.070	41.730	92	202.83
12.247	27	59.525	27.216	60	132.280	42.184	93	205.03
12.701	28	61.729	27.669	61	134.480	42.638	94	207.23
13.154	29	63.934	28.123	62	136.690	43.091	95	209.44
13.608	30	66.139	28.576	63	138.890	43.545	96	211.64
14.061	31	68.343	29.030	64	141.100	43.998	97	213.85
14.515	32	70.548	29.483	65	143.300	44.452	98	216.05
14.968	33	72.753	29.937	66	145.510	44.906	99	218.26

How to convert:

- To convert 10kg into lb, look for the number 10 on the central column of above table, the corresponding number in 'lb' column is the converted value in Pounds (lb).
- Likewise, 10lb could be converted into kg by referring to corresponding entry in kg column.

Table 5 °C - °F Conversion Table

°C		°F	°C		°F	°C		°F	°C		°F
73.0	-100	-148.0	-1.7	29	84.2	17.8	64	147.2	37.2	99	210.2
-62.0	-80	-112.0	-1.1	30	86.0	18.3	65	149.0	37.8	100	212.0
-51.0	-60	-76.0	0.6	31	87.8	18.9	66	150.8	40.6	105	221.0
-40.0	-40	-40.0	0.0	32	89.6	19.4	67	152.6	43.0	110	230.0
-29.0	-20	-4.0	0.6	33	91.4	20.0	68	154.4	49.0	120	248.0
-23.3	-10	14.0	1.1	34	93.2	20.6	69	156.2	54.0	130	266.0
-17.8	0	32.0	1.7	35	95.0	21.1	70	158.0	60.0	140	284.0
-17.2	1	33.8	2.2	36	96.8	21.7	71	159.8	66.0	150	302.0
-16.7	2	35.6	2.8	37	98.6	22.2	72	161.6	71.0	160	320.0
-16.1	3	37.4	3.3	38	100.4	22.8	73	163.4	77.0	170	338.0
-15.6	4	39.2	3.9	39	102.2	23.3	74	165.2	82.0	180	356.0
-15.0	5	41.0	4.4	40	104.0	23.9	75	167.0	88.0	190	374.0
-14.4	6	42.8	5.0	41	105.8	24.4	76	168.8	93.0	200	392.0
-13.9	7	44.6	5.6	42	107.6	25.0	77	170.6	121.0	250	482.0
-13.3	8	46.4	6.1	43	109.4	25.6	78	172.4	149.0	300	572.0
-12.8	9	48.2	6.7	44	111.2	26.1	79	174.2	177.0	350	662.0
-12.2	10	50.0	7.2	45	113.0	26.7	80	176.0	204.0	400	752.0
-11.7	11	51.8	7.8	46	114.8	27.2	81	177.8	232.0	450	842.0
-11.1	12	53.6	8.3	47	116.6	27.8	82	179.6	260.0	500	932.0
-10.6	13	55.4	8.9	48	118.4	28.3	83	181.4	288.0	550	1022.0
-10.0	14	57.2	9.4	49	120.2	28.9	84	183.2	316.0	600	1112.0
-9.4	15	59.0	10.0	50	122.0	29.4	85	185.0	343.0	650	1202.0
-8.9	16	60.8	10.6	51	123.8	30.0	86	186.8	371.0	700	1292.0
-8.3	17	62.6	11.1	52	125.6	30.6	87	188.6	399.0	750	1382.0
-7.8	18	64.4	11.7	53	127.4	31.1	88	190.4	427.0	800	1472.0
-7.2	19	66.2	12.2	54	129.2	31.7	89	192.2	454.0	850	1562.0
-6.7	20	68.0	12.8	55	131.0	32.2	90	194.0	482.0	900	1652.0
-6.1	21	69.8	13.3	56	132.8	32.8	91	195.8	510.0	950	1742.0
-5.6	22	71.6	13.9	57	134.6	33.3	92	197.6	538.0	1000	1832.0
-5.0	23	73.4	14.4	58	136.4	33.9	93	199.4	593.0	1100	2012.0
-4.4	24	75.2	15.0	59	138.2	34.4	94	201.2	649.0	1200	2192.0
-3.9	25	77.0	15.6	60	140.0	35.0	95	203.0	704.0	1300	2372.0
-3.3	26	78.8	16.1	61	141.8	35.6	96	204.8	760.0	1400	2552.0
-2.8	27	80.6	16.7	62	143.6	36.1	97	206.6	816.0	1500	2732.0
-2.2	28	82.4	17.2	63	145.4	36.7	98	208.4	871.0	1600	2912.0

How to convert:

- To convert 100 °C into °F, look for the number 10 on the central column of above table, the corresponding number in "°F" column is the converted value in Fahrenheit.
- Likewise, 10°F could be converted into °C by referring to corresponding entry in "°C" column.

Table 6 International Units SI Conversion Table

Category	Name of unit	Symbol	Conversion SI	SI Name of Unit	SI Abbreviations		
Angle	Degree	°	$\pi/180$	Radian	rad		
	Minute	'	$\pi/10800$				
Length	Second	"	$\pi/648000$	Meter	m		
	Meter	m	10^{-6}				
	Micron	μ	10^{-10}				
	Angstrom	Å	1852				
Area	Nautical Mile	mile	1	Square Meter	m ²		
	Square Meter	m ²	10^2				
	Radius	a	10^4				
Volume	Hectare	ha	1	Cubic Meter	m ³		
	Cubic Meter	m ³	10^3				
Mass	Liter	l	$\approx 1.66057 \times 10^{-27}$	Kilogram	kg		
	Kilogram	kg	10^3				
Time	Ton	t	1	Second	s		
	Atomic Mass Unit	u	10^3				
	Second	s	60				
	Minute	min	3600				
	Hour	h	86400				
Speed	Day	d	1	Meter/Second	m/s		
	Meter Per Second	m/s	1852/3600				
Frequency and Oscillation	Knot	kn	1	Hertz	Hz		
	Cycle	s ⁻¹	1				
Speed of Rotation	Revolution Per Minute	min ⁻¹	1/60	Per Second	s ⁻¹		
Angular Speed	Radial Per Second	rad/s	1	Radian Per Second	rad/s		
Acceleration	Meters Per Second Squared	m/s ²	1	Meters/Second Squared	m/s ²		
	Gravity	G	9.80665				
Force	Kilogram Force Meter	kgf	9.80665	Newton	N		
	Ton Force	tf	9806.65				
	Dyne	dyn	10^{-5}				
Moment of Force	Kilogram Force Meter	kgf•m	9.80665	Newton Meter	N•m		
	Kilogram Force/Meter Squared	kgf/m ²	9.80665				
	Kilogram Force/Centimetre Squared	kgf/cm ²	9.80665×10^4				
Stress and Pressure	Kilogram Force Millimetre Squared	kgf/mm ²	9.80665×10^6	Pascal	Pa		
	Meter of Water	mH ₂ O	9806.65				
	Millimetre of Mercury	mmHg	101325/760				
	Torr	Torr	101325/760				
Pressure	Atmosphere	atm	101325	Pascal	Pa		
	Bar	bar	10^5				
	Erg	erg	10^{-7}			Joule	J
	I.T. Calorie	cal _I	4.1868				
	Kilogram Force Meter	kgf•m	9.80665				
Kilowatt Hour	kw•h	3.600×10^6					
Metric Horsepower Hour	PS•h	$\approx 2.64779 \times 10^6$					
Energy	Electron Volt	eV	$\approx 1.60219 \times 10^{-19}$	Watt	W		
	Watt	W	1				
	Horsepower	PS	≈ 735.5				
	Kilogram Force Meter/Second	kgf•m/s	9.80665				
Viscosity	Poise	P	10^{-1}	Pascal Second	Pa s		
	Centipoise	cP	10^{-3}				
	Kilogram Force/Square Meter	kgf•s/m ²	9.80665				
Kinematic Viscosity	Stoke	St	10^{-4}	Square Meter Per Second	m ² /s		
	Centistoke	cSt	10^{-6}				

DISCLAIMER

Due care has been taken in compiling together all words, diagrams, and data tables in this catalogue. The following pages contain information which is meant only for users having requisite technical knowledge and skill in Bearing selection.

Actual conditions for usage are beyond the scope of this work. The selected Bearing's suitability with the intended application must be reviewed by user's engineering personnel or approved by KG's customer support department.

All information provided hereafter is without warranty/guarantee of any kind. KG International FZCO reserves the right to update or change the information herein at any time without notification. KG International FZCO assumes no liability whatsoever for any direct, indirect, incidental, special or consequential losses or damages, arising due to information contained in this catalogue.

The exhaustive range of Bearings included in this catalogue is current at the time of going to print. However, this information might not necessarily be complete, or updated as on the day viewed by the user. Users are advised to contact KG International FZCO for more updated information, or clarifications.

Notes

A series of 20 horizontal dashed lines for writing notes.

A series of 20 horizontal dashed lines for writing notes.

Notes

A series of horizontal dashed lines for writing notes on page 458.

A series of horizontal dashed lines for writing notes on page 459.



KG International

YOUR ENGINEERING SOLUTION PARTNER



KG International FZCO
P.O. Box 17122, Jebel Ali Free Zone, Dubai
United Arab Emirates
T: +971 4 8815547 | F: +971 4 8816423 / 8818509

www.kginternational.com

ISO CERTIFIED COMPANY
EUROPE | DUBAI | INDIA

