

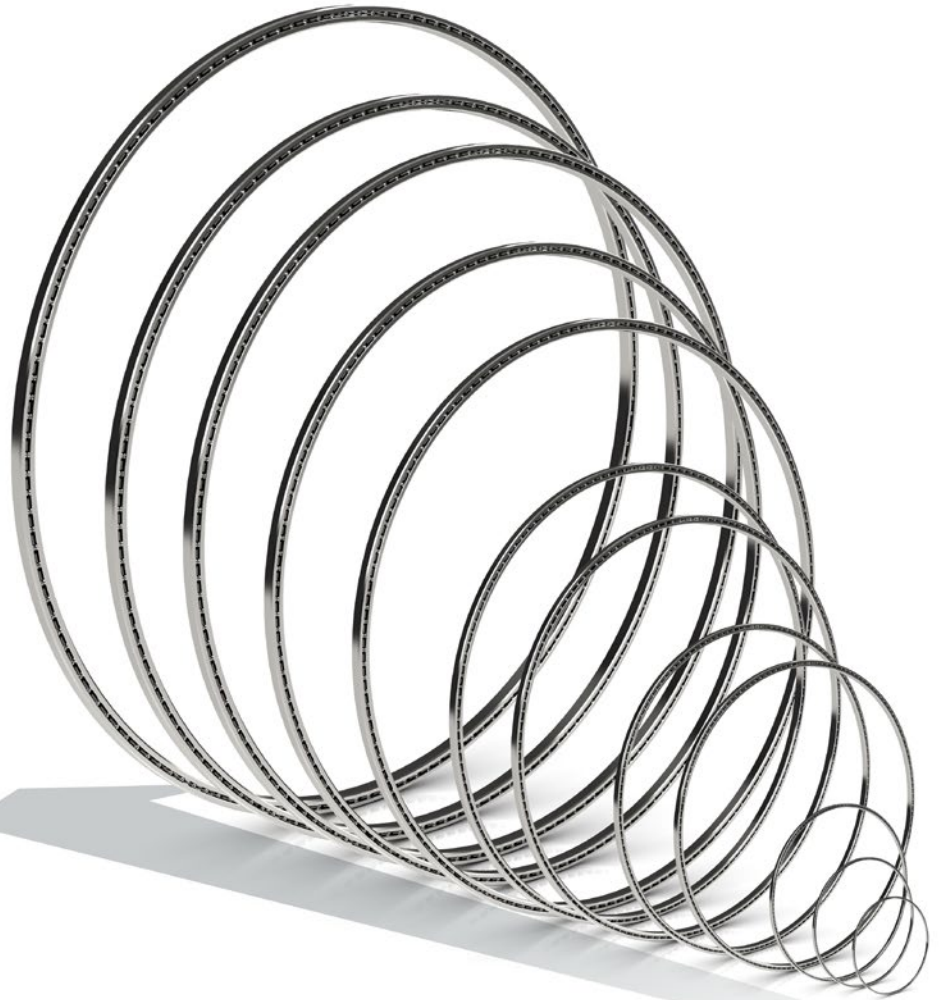

an SKF Group brand

Kaydon **Thinfinite**[®] bearing solutions

Precision Reali-Slim[®] Thin Section Bearings

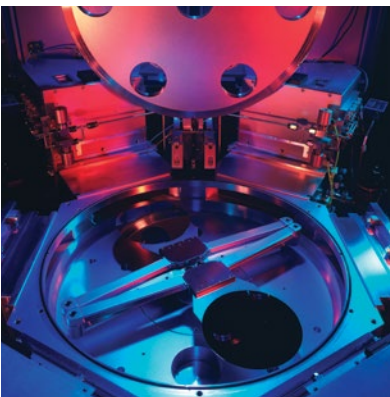

Available from 3/4" to 40"

Identification of Reali-Slim® Bearings

Reali-Slim bearings are marked for complete identification with an (8) or (9) digit part number. Positions 1-8 identify materials, size, type, and precision. Position 9 (optional) identifies non-standard internal fit.

Position	1	2	3	4	5	6	7	8	9
Example	K	G	1	2	0	X	P	0	L
Description	Material	Series	Size	Size	Size	Type	Separator	Precision	Internal Fit

Position 1 – Material

Races/Balls	Seals, Shields
D – AISI 52100 Steel	One shield
E – AISI 52100 Steel	Two shields
H – AISI 52100 Steel	One seal—Nitrile rubber
J – AISI 52100 Steel	Two seals—Nitrile rubber
K – AISI 52100 Steel	No seals or shields
L – AISI 52100 Steel, AISI 440C stainless steel balls	Two seals and Endurakote® plating
M – M-50 Steel	No seals or shields
N – AISI 52100 Steel, AISI 440C stainless steel balls	Endurakote plating and No seals
P – AISI 17-4PH Steel Ceramic Balls (see section 6)	No shields or seals
Q – AISI 52100 Steel (see section 6)	No shields or seals
S – AISI 440C Stainless Steel	No seals or shields
V – AISI 440C Stainless Steel	Two shields
W – AISI 440C Stainless Steel	Two seals—Nitrile rubber
X – AISI 52100 Steel Ceramic Balls (see section 6)	No shields or seals
Y – AISI 440C Stainless Steel Ceramic Balls (see section 6)	No shields or seals
Z – Other	

Position 2 – Series Standard Cross Section

Open Bearings

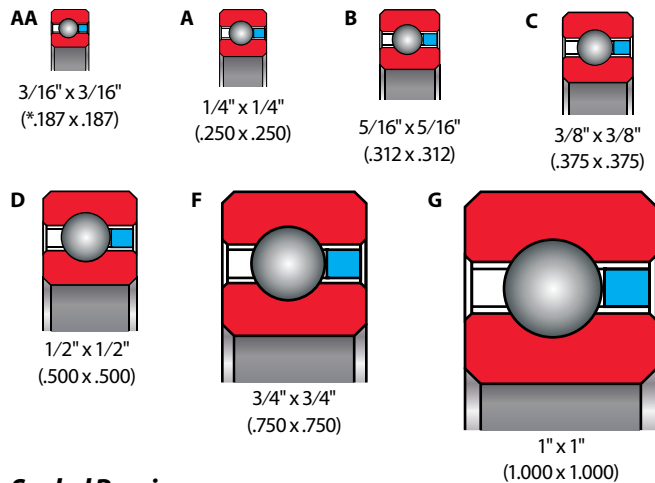

Sealed Bearings

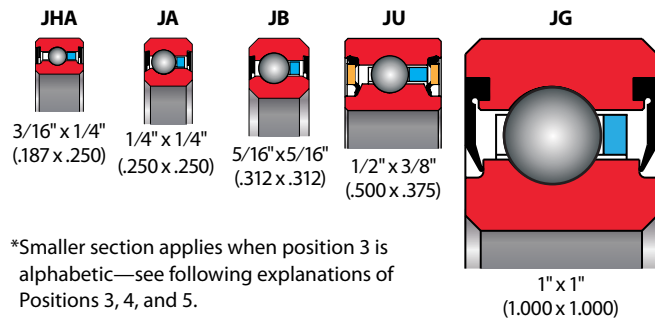

Position 3, 4 and 5 – Size (Bearing Bore)

Numeric Characters - Nominal bearing bore in inches multiplied by ten

Alphabetic Characters -

"A" In Position 3 in combination with "A" in Position 2 denotes .187 x .187 Series

"A" In Position 3 in combination with "H" in Position 2 denotes .187 x .250 Series

Examples - 040 = 4.0" Bore, 120 = 12.0" Bore, 400 = 40.0" Bore





"10" following "AA" in Positions 2 & 3 = .187 x .187 Series with 1.0" Bore

"15" following "HA" in Positions 2 & 3 = .187 x .250 Series with 1.5" Bore

Identification of Reali-Slim Bearings (continued)

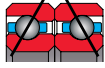
Position	1	2	3	4	5	6	7	8	9
Example	K	G	1	2	0	X	P	0	L
Description	Material	Series	Size	Size	Size	Type	Separator	Precision	Internal Fit

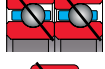
Position 6 – Bearing Type

- A**  Angular contact single bearing (not ground for universal duplexing)
- B**  Angular contact pair—duplexed back to back
- C**  Radial contact
- F**  Angular contact pair—duplexed face to face
- T**  Angular contact pair—duplexed tandem
- U**  Angular contact single bearing—ground for universal duplexing
- X**  Four-point contact
- Z** Other

Position 7 – Separator - Bearing Type noted



- C** Non-metallic composite, segmental, “snap-over” type - C, X
- D** Phenolic laminate, one-piece ring, “snap-over” type - C, X
- E** Brass, segmental “snap-over” type - C, X
- L** Nylon one-piece molded ring with “snap-over” pockets - C, X
- N** Nylon molded strip with “snap-over” pockets - C, X
- P** Standard one-piece formed ring with “snap-over” pockets - C, X
- T** Stainless steel, formed ring “snap-over” type - C, X
- V** Brass, formed ring, “snap-over” pockets - C, X
- X** PEEK, one-piece molded ring with “snap-over” pockets - C, X



- G** Nylon one-piece molded ring with circular pockets - A
- H** Phenolic laminate one-piece machined ring with circular pockets - A
- J** Nylon molded strip with circular pockets - A
- K** Phenolic laminate, riveted two-piece ring type - A, C, X
- Q** PEEK, one-piece molded ring with circular pockets - A
- R** Standard one-piece formed ring with circular pockets - A
- U** Stainless steel, formed ring circular pockets type - A
- Y** Brass, formed ring, circular pockets type - A



- M** Formed wire strip or segmental cage, “snap-over” pockets - A, C, X
- W** Formed wire strip or segmental cage, “snap-over” pockets - C, X



- F** Full complement bearing - A, C, X
- S** Helical coil spring - C, X
- Z** Other (toroid ball spacers, spacer slugs, spacer ball or others available) - A, C, X

Position 8 – Precision

(ABEC Specifications are per ABMA Standard 26.2)

- 0** Kaydon Precision Class 1 per ABEC 1F
- 1** Kaydon Precision Class 1 with Class 4 Runouts
- 2** Kaydon Precision Class 1 with Class 6 Runouts
- 3** Kaydon Precision Class 3 per ABEC 3F
- 4** Kaydon Precision Class 4 per ABEC 5F
- 6** Kaydon Precision Class 6 per ABEC 7F
- 8** Other

Position 9 – Bearing Internal Fit

- | | |
|-------------------------------------|---|
| A .0000" to .0005" Clearance | K .0000" to .0005" Preload |
| B .0000" to .0010" Clearance | L .0000" to .0010" Preload |
| C .0005" to .0010" Clearance | M .0005" to .0010" Preload |
| D .0005" to .0015" Clearance | N .0005" to .0015" Preload |
| E .0010" to .0020" Clearance | P .0010" to .0020" Preload |
| F .0015" to .0025" Clearance | Q .0010" to .0015" Preload |
| G .0020" to .0030" Clearance | R .0015" to .0025" Preload |
| H .0030" to .0040" Clearance | S .0020" to .0030" Preload |
| I .0040" to .0050" Clearance | Z Other clearance or preload not specified above |
| J .0050" to .0060" Clearance | |

Blank Standard default clearance (see Precision Tolerances tables in Section 2 of Catalog 300 for default clearance by bearing size)

■ Type X or C = Diametral Preload or Clearance

■ Duplexed Type A = Axial Preload or Clearance

Note: Above internal bearing fits apply to unmounted bearings only. Mounting fits can greatly affect final internal bearing fit.

Kaydon® Makes It Easy to Design with Reali-Slim Bearings

As comprehensive as each new edition of this catalog is, it's just one of many tools developed by Kaydon Bearings to help engineers evaluate thin section bearings for their applications. At our website (www.kaydonbearings.com), for example, you'll find CAD downloads, an interactive bearing selector and advanced design software to make your job much easier.

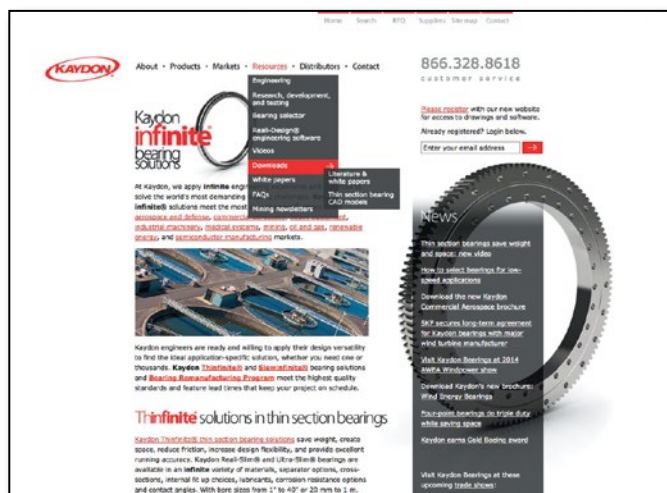

CAD Downloads

CAD drawings are available for download in 38 different formats (e.g., AutoCAD, DXF, SolidWorks). Simply select the type of bearing you want from the drop-down menu and go to its page. There you can find the part number that matches the dimensions or capacities you need. Simply register or log in, and you'll be able to download the file by clicking on the part number.

From there you can view the bearing in 3D or download the file in your preferred format.

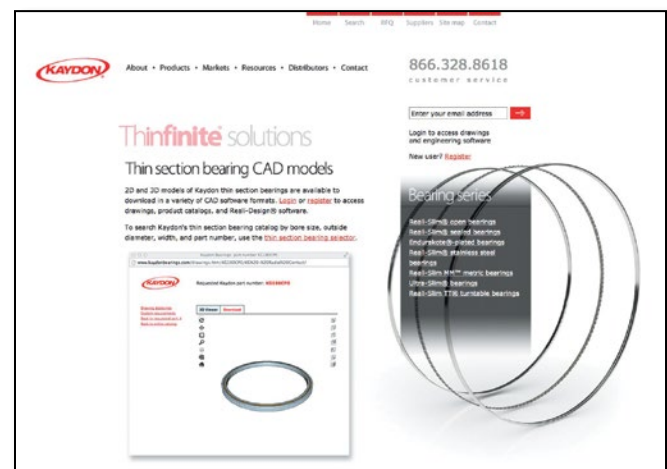

Interactive Bearing Selector

Kaydon's interactive bearing selector lets you search our online catalog and download 2D or 3D drawings to simplify the selection process. Search by part number (even if it's incomplete) or by bore size, outside diameter, and/or width minimums and maximums... in inches or millimeters.

Search by size

Specify inch bearings, metric bearings, or both, then fill in one or all spaces to search by minimum and/or maximum dimensions.

Bearing series Inch bearings (inches) Metric bearings (mm) Both inch and metric bearings

Show results in inches mm

	Minimum	Maximum	Available sizes*
Bore size	<input type="text"/>	<input type="text"/>	0.9843" - 40.0000"
Outside diameter	<input type="text"/>	<input type="text"/>	1.3750" - 42.0000"
Width	<input type="text"/>	<input type="text"/>	0.0984" - 1.0000"

* Search criteria is based on nominal dimensions

Reali-Design® and Reali-Design MM®

When Kaydon introduced it in 1994, Reali-Design software quickly became the go-to program for anyone thinking about specifying thin section bearings. This innovative program has saved engineers countless hours by doing complex power transmission computations for them.



Reali-Design and Reali-Design MM software (for Reali-Slim inch and metric bearings, respectively), can:

- save hours of tedious computations
- reduce bearing selection time to seconds
- accurately compute essential life and load analyses
- determine safe operating speeds
- calculate load deflections

These programs (PC System requirements: Windows® 95 or later; 50 MB of free drive space) are valuable supplements to this catalog. They include a CAD-ready DXF library, training modules, data sheet creation program, life calculations, torque and deflection graphs, and much more.

For more details of this user-friendly software, turn to [Page 110](#). To get your copy of Reali-Design (including Reali-Design MM), contact Kaydon or simply download it from our website, www.kaydonbearings.com.

Table of Contents

**Page
Number**

Section 1— An Introduction to Reali-Slim Thin Section Bearings.....	7
■ Product Line Overview.....	8
■ Examples of Design Efficiency.....	9
■ Bearing Load Scenarios.....	10
■ General Information and Availability Chart.....	12
■ General Specifications for Standard Bearings.....	13
Section 2— Selection Tables for Standard Reali-Slim Bearings.....	14
■ Open Reali-Slim Bearings Inch Series, AISI 52100 – Types A, C, X.....	15
■ Sealed Reali-Slim Bearings, AISI 52100 – Types C, X.....	27
■ Precision Tolerances and Recommended Fits for Reali-Slim Bearings.....	35
■ Endurakote - Plated Reali-Slim Bearings.....	40
■ Precision Tolerances and Recommended Fits for Reali-Slim Bearings with Endurakote Plating.....	54
■ Stainless Steel Reali-Slim Bearings.....	59
■ Stainless Steel Open Reali-Slim Bearings – Types A, C, X.....	60
■ Reali-Slim MM® Metric Series Bearings – Types A, C, X.....	72
■ Precision Tolerances and Recommended Fits for Reali-Slim MM Metric Series Bearings.....	79
■ Metric Series Ball Bearings (BB Series).....	80
■ Ultra-Slim® Thin Section Bearings – Types A, C, X.....	83
■ Precision Tolerances and Recommended Fits for Ultra-Slim Bearings.....	85
■ Reali-Slim TT® Series Small-scale, Thin Section Turntable Bearings.....	86
Section 3— Applications Engineering.....	89
■ Selection Recommendations.....	90
■ Capacity, Life, and Load Analysis.....	95
Section 4— Separator Types, Bearing Performance and Reali-Design Software... 99	99
■ Separator Types.....	100
■ Limiting Speeds.....	104
■ Torque.....	106
■ Axis Deviation.....	108
■ Reali-Design and Reali-Design MM Software.....	110
Section 5— Mounting, Installation and Maintenance of Reali-Slim Bearings.....	112
■ Mounting Recommendations.....	113
■ Inspection and Installation Procedures.....	118
■ Lubrication and Maintenance.....	120
Section 6— Other Products.....	122
■ Bearings for Demanding Applications.....	123
■ KT Series Tapered Roller Bearings.....	125
Section 7— Appendix and Sales Information.....	126
■ Terms and Definitions.....	127
■ Warranty Information and Legal Notices.....	128
■ Design Aids and Technical Literature.....	131
■ Distributors and Other Help.....	132
■ Request for Bearing Proposal Data Form.....	133
■ Conversion Factors.....	135

Reali-Slim... For Compact, Lightweight Designs of the Future

Many years ago, Kaydon engineers trying to help designers fit assemblies into smaller spaces had an idea: what if the bearing cross-section didn't increase as the bore size got bigger? This led them to develop new bearings with a cross-section that remained constant: Reali-Slim thin section bearings.

Reali-Slim bearings produce larger ratios of diameter to radial section, which lead to space and weight savings of up to 85

percent. Such savings typically have a ripple effect, and have been known to eliminate enough material and/or components to reduce system cost by 40 percent.

Despite their slim profile, Reali-Slim bearings have enough load capacity to handle a wide range of applications. A few appear here; for more, please download our Applications Guide at www.kaydonbearings.com/downloads.htm.

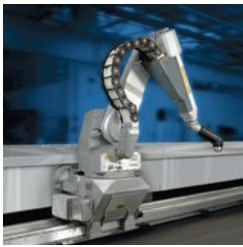

Industrial Machinery

- Machine tools
- Robots
- Optical scanning and imaging equipment
- Food processing machinery
- Packaging equipment



Oil & Gas

- Rotating drill rig equipment
- Pipe inspection equipment
- Iron roughnecks
- Power swivels



Aerospace & Defense

- Target systems and tank sights
- Navigation, target acquisition pods
- Helicopter swash plates and gearboxes
- Propulsion and control systems
- Radar
- Satellites
- Mars Rover



Medical

- CT scanners
- Laboratory diagnostic equipment
- Surgical robotics
- Surgical chairs, tables

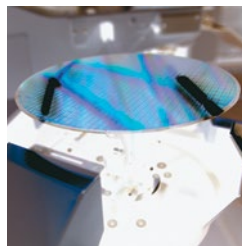

Semiconductor Machinery

- Pick and place robotics
- Lapping equipment
- Wafer etching, scrubbing and polishing



Renewable Energy

- Solar panel altitude-azimuth mountings
- Solar panel gearboxes

Section 1 — An Introduction to Reali-Slim Thin Section Bearings

	Page Number
■ Product Line Overview	8
■ Examples of Design Efficiency	9
■ Bearing Load Scenarios	10
■ Product Availability Chart	12
■ Specifications for Standard Bearings	13

The design and application information contained in this catalog is for illustration only. Responsibility for the application of the products contained in this catalog rests solely with the equipment designer or user. In spite of our best efforts, the material contained in this catalog may contain inaccuracies and typographical errors.

Product Line Overview

The inch family of Real-Slim thin section bearings includes seven open series (Figure 1-2) and five sealed series (Figure 1-3), ranging in bore diameters from 1.000 inch to 40.000 inches. Series range from .187 x .187 inch to 1.000 x 1.000 inch in cross-section. Open bearings are available from stock in three configurations (Types A, C & X). Stock sealed bearings are available in Types C & X only.

We can provide internal fit up, lubricants, separators and other features to meet the most demanding specifications. To obtain corrosion resistance consider using the Kaydon stainless steel Real-Slim or Endura-Slim® series of bearings. Endurakote plating provides corrosion protection equal to or better than a full AISI 440C stainless steel bearing and can be supplied with very quick delivery.

Additional product line variants include Real-Slim MM metric series bearings (Figure 1-4), Ultra-Slim bearings (Figure 1-1), Real-Slim TT series turntable bearings, BB metric ball bearings (all found in Section 2), Bearings for Demanding Applications, and KT thin section taper bearings (Section 6).

Within these families, you can generally choose between open bearings for applications where bearings will not be exposed to damaging particulates and sealed bearings for applications where bearings need to be kept clean and well-lubricated.

To support various load scenarios, Real-Slim bearings are available in three basic types: radial contact (Type C), angular contact (Type A), and four-point contact (Type X)—see [pages 10 and 11](#) for explanations of each type—and in a variety of sizes, or series (e.g., KA, KB, KC, etc.).

Real-Slim bearings are available with various separator options to space the rolling elements uniformly and prevent contact between them. Separator types available include:

continuous ring “snap-over pocket”, continuous ring circular pocket, formed wire, toroid, PTFE spacers, and spacer ball separators. See Section 4 for complete details.

Specification Control

In today’s world, product traceability is extremely important. To satisfy these requirements, requesting a “specification control drawing” for a Real-Slim bearing is a valuable option to consider.

A specification control drawing provides the user a concise description of the important bearing features and parameters for a specific bearing. A specification control drawing request will generate a unique part number for the standard Real-Slim bearing, including the commercially available options you have selected. This provides the customer quick and easy identification of product in the field as well as a concise receiving and inspection document for the factory.

Real-Slim Bearings Improve Design Efficiency

In Real-Slim bearings, each series is based on a single cross-section which remains constant as the bore diameter is increased. This is in sharp contrast to standard bearings in which the cross-section increases as the bore diameter increases. The constant cross-section of a Real-Slim bearing is of particular value when designing a product which will be manufactured in various sizes based on shaft diameter and power requirements (Figure 1-5). By using the same series of Real-Slim bearings throughout a product line, the designer can standardize on common components. For all diameters of this rotary table your bearing envelope stays the same.

**Figure 1-1,
Ultra-Slim
Bearings**



**Ultra-Slim
2.5mm x 3mm**

Figure 1-2, Inch Bearings, Open



**Series AA
 $\frac{3}{16}'' \times \frac{3}{16}''$**



**Series A
 $\frac{1}{4}'' \times \frac{1}{4}''$**

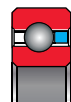

**Series B
 $\frac{5}{16}'' \times \frac{5}{16}''$**

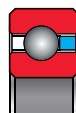

**Series C
 $\frac{3}{8}'' \times \frac{3}{8}''$**

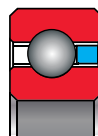

**Series D
 $\frac{1}{2}'' \times \frac{1}{2}''$**

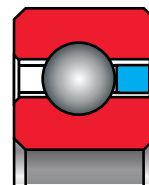

**Series F
 $\frac{3}{4}'' \times \frac{3}{4}''$**

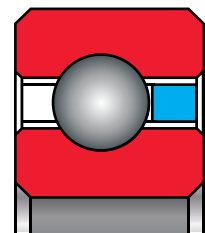

**Series G
1" x 1"**

Product Line Overview (continued)

Figure 1-5

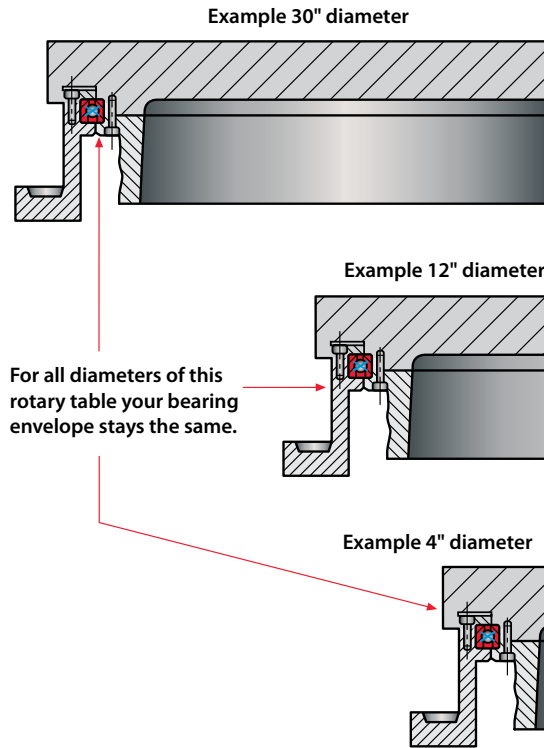

Reali-Slim Bearings Make a More Compact Design

Additional advantages in application design made possible by Reali-Slim bearings can be seen by referring to Figures 1-6, 1-7, and 1-8. A large bore, small cross-section Reali-Slim bearing permits the use of a large diameter hollow shaft (Figure 1-7) in place of a smaller diameter solid shaft (Figure 1-6), king-post design. Components such as air and hydraulic lines or electrical wiring and slip rings can then be accommodated within the hollow shaft, resulting in a neater, more efficient design.

In many applications, a single four-point contact Reali-Slim bearing (Figure 1-8) can replace two bearings (Figures 1-6 and 1-7) compacting the design and simplifying the bearing mounting. Besides the obvious cost savings of eliminating one bearing, this arrangement also creates space and saves weight. The use of Reali-Slim bearings also provides a stiffer structure by using large diameter hollow tubes to replace solid shafts and by supporting the rotating structure (table) at the periphery.

Figure 1-6

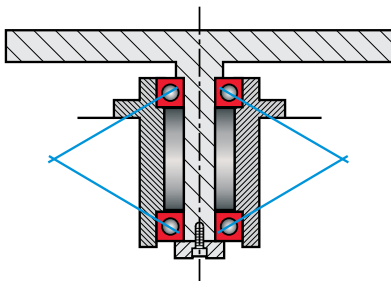

Figure 1-7

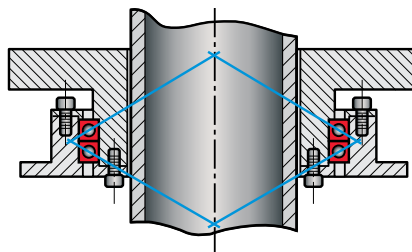

Figure 1-8

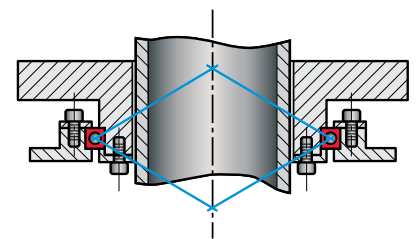
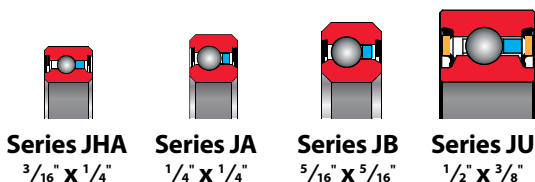
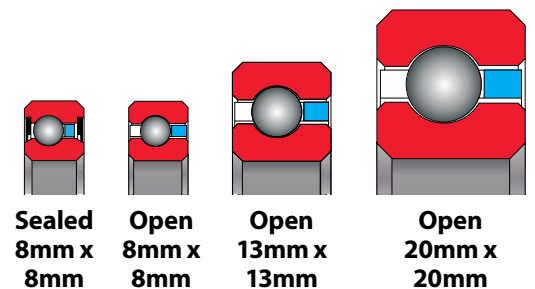

Figure 1-3, Inch Bearings, Sealed



Series JHA $\frac{3}{16} \times \frac{1}{4}$ **Series JA** $\frac{1}{4} \times \frac{1}{4}$ **Series JB** $\frac{5}{16} \times \frac{5}{16}$ **Series JU** $\frac{1}{2} \times \frac{3}{8}$

Figure 1-4, Metric Bearings



Sealed 8mm x 8mm **Open** 8mm x 8mm **Open** 13mm x 13mm **Open** 20mm x 20mm

Reali-Slim Bearing Types

Support All Load Scenarios

Radial and Axial (Thrust) Loads

Bearings support a shaft or housing to permit their free motion about an axis of rotation. Load can be applied to bearings in either of two basic directions (Figure 1-9). Radial loads act at right angles to the shaft (bearing's axis of rotation). Axial (thrust) acts parallel to the axis of rotation. When these loads are offset from either the bearing axis (distance S_t) or radial plane (distance S_r), a resulting moment load (M) will be created. Reali-Slim bearings are available in a variety of types to handle radial loads, axial loads and moment loads.

Figure 1-9

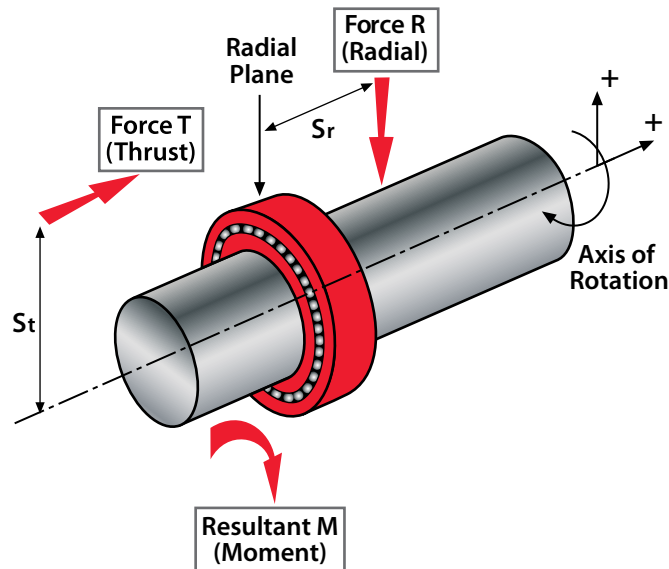

The resultant moment load (M) equation:
 $M = (\pm T) (S_t) + (\pm R) (S_r)$

Types of Reali-Slim Bearings

Reali-Slim bearings are available in three basic configurations: radial (Type C), angular contact (Type A), and four-point contact (Type X).

Reali-Slim Bearing Types

A = angular

C = radial

X = four-point

By using these three types, the customer has a wider choice of mounting arrangements to meet load, stiffness and accuracy requirements in the most efficient manner.

Radial Contact Bearing (Type C)

The Type C Radial Contact Bearing (Figure 1-10) is a single row radial ball bearing of conventional design. It is a Conrad-type assembly, which means that it is assembled by eccentric displacement of the inner race within the outer race which permits insertion of about half of a full complement of balls.

Reali-Slim Type C

Figure 1-10

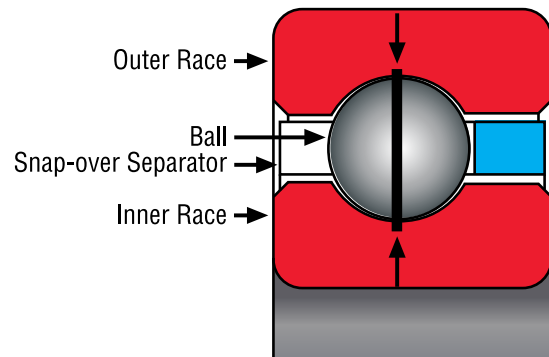

Although the Type C bearing is designed primarily for radial load application, it can be configured to accept some axial (thrust) load in either direction. But, if thrust is a concern, a set of angular contact bearings should be considered for the specific application.

Reali-Slim Bearing Types Support All Load Scenarios (continued)

Angular Contact Bearing (Type A)

The Type A bearing is also a conventional design. It features a circular pocket separator and a 30° contact angle (see Figure 1-11) along with approximately 67% of a full complement of balls.

The chief benefit of the Type A bearing is that it provides greater thrust capacity than a Type C or Type X bearing. Because of its counterbored outer race, a Type A bearing has unidirectional thrust capacity. Thus, this bearing should be mounted opposed to another bearing to establish and maintain the contact angle, and to support reversing thrust loads.

Reali-Slim Type A

Figure 1-11

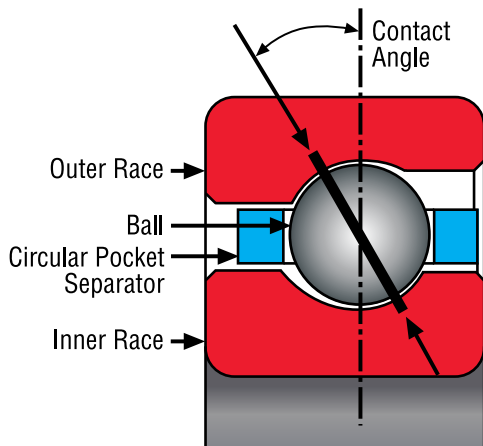

Four-Point Contact Bearing (Type X)

Standard bearing lines are most often designed to handle either radial or axial load conditions. The unique feature of the Reali-Slim Type X four-point contact bearing line (see Figure 1-12)

is that the gothic arch geometry of the inner and outer races enables a single bearing to carry three types of loading (radial, axial and moment) simultaneously. This makes it the bearing of choice for many applications since a single four-point contact bearing can often replace two bearings, providing a simplified design.

Type X bearings may also be furnished with an internal diametral preload for those applications requiring greater stiffness or zero free play. This is accomplished by using balls that are larger than the space provided between the raceways. The balls and raceways, therefore, have some elastic deformation in the absence of an external load.

Reali-Slim Type X

Figure 1-12

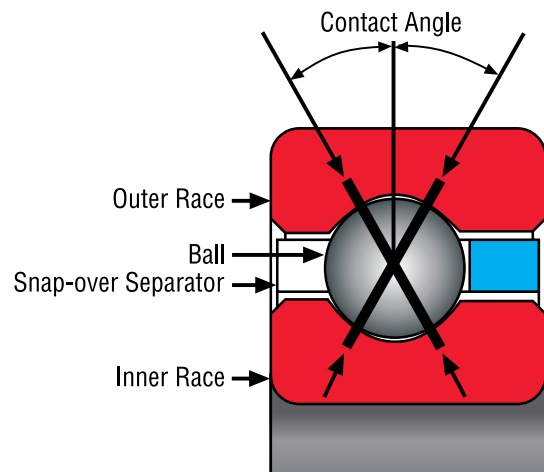

NOTE: Kaydon does not recommend the use of two Type X bearings on a common shaft, as it could result in objectionable friction torque.

General Information and Availability Chart

Standard Reali-Slim Bearings—are those listed in the Series Data Tables. They are manufactured to Kaydon Precision Class 1 and the specifications on [page 13](#). New sizes are added to stock periodically and updated on our website. Be sure to visit www.kaydonbearings.com for latest information.

Options

Reali-Slim Bearings—can be optimized for your special requirements. Standard commercial options include: changes in diametral clearance, preloading, lubricants, packaging, etching of high points, tagging bearings with actual dimensions as requested, separators, duplexing, data sheets, acceptance testing, etc.

Reali-Slim Bearings—can be ordered with non-standard materials, sizes, tolerances, specifications, and features as well as custom packaging and lubrication options. We also have ISO Class 7 facilities for applications requiring cleanroom assembly. We will be pleased to quote on your requirements.

Order Reali-Slim Bearings—by bearing numbers shown in Series Data Tables.

Assistance—in bearing selection will be furnished by our regional sales managers or the Kaydon Engineering Department upon request.

Changes—Due to Kaydon's continuing program of product improvement, we reserve the right to change specifications and other information included in this catalog without notice.

Figure 1-13

The following table shows the availability of AISI 52100 standard Reali-Slim bearings. For the availability of Reali-Slim MM bearings, please see [page 72](#). For stainless steel bearings, please see Section 2.

Series	Type	Bore Diameter In Inches																																		
		³ / ₄	1	1 ¹ / ₂	1 ³ / ₄	2	2 ¹ / ₂	3	3 ¹ / ₂	4	4 ¹ / ₄	4 ³ / ₄	5	5 ¹ / ₂	6	6 ¹ / ₂	7	7 ¹ / ₂	8	9	10	11	12	14	16	18	20	21	22	25	30	35	40			
JHA Series	A																																			
³ / ₁₆ " Radial	C																																			
Section	X																																			
KAA Series	A																																			
³ / ₁₆ " Radial	C																																			
Section	X																																			
JA Series	A																																			
¹ / ₄ " Radial	C																																			
Section	X																																			
KA Series	A																																			
¹ / ₄ " Radial	C																																			
Section	X																																			
JB Series	A																																			
⁵ / ₁₆ " Radial	C																																			
Section	X																																			
KB Series	A																																			
⁵ / ₁₆ " Radial	C																																			
Section	X																																			
KC Series	A																																			
³ / ₈ " Radial	C																																			
Section	X																																			
JU Series	A																																			
³ / ₈ " Radial	C																																			
Section	X																																			
KD Series	A																																			
¹ / ₂ " Radial	C																																			
Section	X																																			
KF Series	A																																			
³ / ₄ " Radial	C																																			
Section	X																																			
JG Series	A																																			
1" Radial	C																																			
Section	X																																			
KG Series	A																																			
1" Radial	C																																			
Section	X																																			

Many bore diameters are available from stock; call Kaydon for details.

Specifications for Standard Reali-Slim Bearings

ITEM	DESCRIPTION	REFERENCE SPECIFICATION
MATERIAL ANALYSIS		
RACES & BALLS	SAE-AISI 52100 Type Steel AISI 440C Stainless Steel	ASTM A-295 AMS-5630
SEPARATORS C, X BEARINGS	P Type—Brass or Non-metallic composite L Type—Nylon, Fiberglass Reinforced	ASTM B-36
A BEARINGS	R Type—Brass or Non-metallic composite G Type—Nylon, Fiberglass Reinforced	ASTM B-36
SEALS	Nitrile Rubber	
HEAT TREATMENT		
RACES AND BALLS	Through hardened and dimensionally stabilized for use from -65°F to +250°F (-54°C to +121°C)	
PRECISION		
RACE DIMENSIONS	Kaydon Precision Class 1	ABMA ABEC-1F or better, per ABMA Standard 26.2
RACE RUNOUTS	Kaydon Precision Class 1	ABMA ABEC-1F or better, per ABMA Standard 26.2
BALLS	ABMA Grade 10	ANSI/ABMA/ISO 3290
DIAMETRICAL CLEARANCE AND CONTACT ANGLE		
TYPE C BEARING	Sufficient diametral clearance to provide small amount of running clearance after installation with recommended fits.	
TYPE X BEARING	Gothic Arch Form for two 30° contact angles under light radial gaging load. Sufficient diametral clearance to provide clearance after installation with recommended fits.	
TYPE A BEARING	Diametral clearance for 30° contact angle in single unmounted bearing under light axial gaging load. Wide range of preload or running clearance for matched sets.	
SEPARATOR DESIGN		
P & L TYPES C, X BEARINGS	Circular Ring, Snapped Over Balls for Retention	
R & G TYPES A BEARINGS	Circular Ring, Circular Pockets, Self Retained	
OTHER		
QUALITY CONTROL	Kaydon Quality Control procedures have been approved by major aerospace industries and agencies of the U.S. Government	ISO 9001, AS 9100
IDENTIFICATION	Marked on Bearing O.D.: CAGE Code, "Kaydon"®, Part Number and Date Code	MIL-STD-130
CLEANING	Multiple cycle immersion and agitation in solvents and/or aqueous cleaners	
PRESERVATIVE	Preservative Oil	
PACKAGING	Typically, smaller bearings are heat-sealed in a plastic bag and boxed; larger bearings are "tire-wrapped."	

Section 2 — Selection Tables for Standard Reali-Slim Bearings

	Page Number
■ Open Reali-Slim Bearings Inch Series, AISI 52100 – Types A, C, X	15
■ Sealed Reali-Slim Bearings, AISI 52100 – Types C, X	27
■ Precision Tolerances and Recommended Fits for Reali-Slim Bearings	35
■ Endurakote - Plated Reali-Slim Bearings	40
■ Precision Tolerances and Recommended Fits for Reali-Slim Bearings with Endurakote Plating	54
■ Stainless Steel Reali-Slim Bearings	59
■ Stainless Steel Open Reali-Slim Bearings – Types A, C, X	60
■ Reali-Slim MM Metric Series Bearings – Types A, C, X	72
■ Precision Tolerances & Recommended Fits for Reali-Slim MM Metric Series Bearings	79
■ Metric Series Ball Bearings (BB Series)	80
■ Ultra-Slim Thin Section Bearings – Types A, C, X	83
■ Precision Tolerances & Recommended Fits for Ultra-Slim Bearings	85
■ Reali-Slim TT Series Small-scale, Thin Section Turntable Bearings	86

Open Reali-Slim Bearing Selections

Type A – ANGULAR CONTACT

A deep groove bearing with reduced shoulder on one side of inner or outer race ball path. Snap-over assembly permits use of a one-piece circular pocket ring separator and greater ball complement. These bearings will accept radial load and single direction thrust load and are normally used in conjunction with another bearing of similar construction. Type A bearings require

the application of thrust to establish contact angle. Stock bearings are individual units and when purchased as such must be adjusted at installation to desired running clearance or preload. If preferred, matched sets are available. Kaydon also offers matched spacers for applications requiring extra precision. Kaydon can provide this service direct from the factory.

KAA Series											
KAYDON Bearing Number	Dimensions in Inches					Capacities in Pounds ^①					Approx. Wt. in lbs.
	Size		Land Diameters			Dynamic		Static ^②			
	Bore	Outside Dia.	L ₁	L ₂	C'Bore L ₃	KAYDON Radial	ISO Radial ^③	Thrust	Radial	Thrust	
KAA10AGO	1.000	1.375	1.140	1.235	1.274	194	590	450	340	970	.025
KAA15AGO	1.500	1.875	1.640	1.735	1.774	238	681	560	480	1,380	.038
KAA17AGO	1.750	2.125	1.890	1.985	2.024	251	697	600	530	1,520	.045

Circular pocket separator 3/32" balls

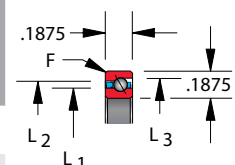

④ F = .015

Bearing corners are normally chamfered

KA Series											
KAYDON Bearing Number	Dimensions in Inches					Capacities in Pounds ^①					Approx. Wt. in lbs.
	Size		Land Diameters			Dynamic		Static ^②			
	Bore	Outside Dia.	L ₁	L ₂	C'Bore L ₃	KAYDON Radial	ISO Radial ^③	Thrust	Radial	Thrust	
KA020ARO	2.000	2.500	2.186	2.314	2.369	405	1,065	960	790	2,280	.10
KA025ARO	2.500	3.000	2.686	2.814	2.869	459	1,150	1,100	960	2,780	.12
KA030ARO	3.000	3.500	3.186	3.314	3.367	507	1,225	1,230	1,140	3,290	.14
KA035ARO	3.500	4.000	3.686	3.814	3.867	552	1,292	1,350	1,310	3,790	.17
KA040ARO	4.000	4.500	4.186	4.314	4.367	595	1,353	1,470	1,490	4,300	.19
KA042ARO	4.250	4.750	4.436	4.564	4.615	616	1,382	1,530	1,580	4,550	.20
KA045ARO	4.500	5.000	4.686	4.814	4.865	637	1,410	1,580	1,660	4,810	.21
KA047ARO	4.750	5.250	4.936	5.064	5.115	657	1,437	1,640	1,750	5,060	.22
KA050ARO	5.000	5.500	5.186	5.314	5.365	676	1,463	1,690	1,840	5,310	.23
KA055ARO	5.500	6.000	5.686	5.814	5.863	715	1,513	1,800	2,020	5,820	.25
KA060ARO	6.000	6.500	6.186	6.314	6.363	752	1,561	1,900	2,190	6,320	.28
KA065ARO	6.500	7.000	6.686	6.814	6.861	788	1,605	2,000	2,370	6,830	.30
KA070ARO	7.000	7.500	7.186	7.314	7.361	823	1,648	2,100	2,540	7,340	.32
KA075ARO	7.500	8.000	7.686	7.814	7.861	857	1,689	2,190	2,720	7,840	.34
KA080ARO	8.000	8.500	8.186	8.314	8.359	890	1,728	2,280	2,890	8,350	.36
KA090ARO	9.000	9.500	9.186	9.314	9.357	954	1,802	2,470	3,240	9,360	.41
KA100ARO	10.000	10.500	10.186	10.314	10.355	1,014	1,871	2,640	3,590	10,370	.45
KA110ARO	11.000	11.500	11.186	11.314	11.353	1,072	1,936	2,810	3,940	11,380	.50
KA120ARO	12.000	12.500	12.186	12.314	12.349	1,128	1,998	2,970	4,290	12,390	.54

Circular pocket separator 1/8" balls

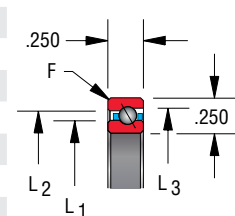

④ F = .025

Bearing corners are normally chamfered

① Capacities listed are not simultaneous. For combined loading see discussion of [Bearing Selection](#) and [Load Analysis](#). Dynamic capacities are based upon 1 million revolutions of L10 life. Published capacities do not apply to hybrid series bearings P, X, and Y - contact Kaydon product engineering for values.

② Static capacities are non-brinell limits based on rigid support from the shaft and housing.

③ ISO Radial ratings are calculated per ISO 281:1990. They are included for comparison only (refer to [Page 95](#)).

④ "F" is the maximum shaft or housing fillet radius the bearing corners will clear.

Type A – Open Reali-Slim Bearings, ANGULAR CONTACT

KB Series											
KAYDON Bearing Number	Dimensions in Inches					Capacities in Pounds ^①					Approx. Wt. in lbs.
	Size		Land Diameters			Dynamic			Static ^②		
	Bore	Outside Dia.	L ₁	L ₂	C'Bore L ₃	KAYDON Radial	ISO Radial ^③	Thrust	Radial	Thrust	
KB020ARO	2.000	2.625	2.231	2.393	2.464	601	1,520	1,380	1,090	3,150	.15
KB025ARO	2.500	3.125	2.731	2.893	2.964	675	1,650	1,590	1,340	3,860	.19
KB030ARO	3.000	3.625	3.231	3.393	3.462	734	1,737	1,750	1,550	4,470	.22
KB035ARO	3.500	4.125	3.731	3.893	3.962	801	1,840	1,930	1,790	5,180	.27
KB040ARO	4.000	4.625	4.231	4.393	4.460	865	1,934	2,100	2,040	5,890	.30
KB042ARO	4.250	4.875	4.481	4.643	4.710	891	1,967	2,170	2,150	6,200	.31
KB045ARO	4.500	5.125	4.731	4.893	4.960	917	2,000	2,240	2,250	6,500	.34
KB047ARO	4.750	5.375	4.981	5.143	5.210	951	2,051	2,340	2,390	6,910	.35
KB050ARO	5.000	5.625	5.231	5.393	5.460	976	2,081	2,410	2,500	7,210	.37
KB055ARO	5.500	6.125	5.731	5.893	5.958	1,033	2,158	2,560	2,740	7,920	.40
KB060ARO	6.000	6.625	6.231	6.393	6.458	1,088	2,230	2,710	2,990	8,630	.44
KB065ARO	6.500	7.125	6.731	6.893	6.958	1,132	2,281	2,840	3,200	9,240	.47
KB070ARO	7.000	7.625	7.231	7.393	7.456	1,184	2,347	2,980	3,450	9,960	.50
KB075ARO	7.500	8.125	7.731	7.893	7.955	1,235	2,409	3,120	3,700	10,670	.54
KB080ARO	8.000	8.625	8.231	8.393	8.453	1,284	2,469	3,260	3,940	11,380	.57
KB090ARO	9.000	9.625	9.231	9.393	9.451	1,370	2,568	3,510	4,400	12,700	.64
KB100ARO	10.000	10.625	10.231	10.393	10.449	1,461	2,673	3,760	4,890	14,120	.71
KB110ARO	11.000	11.625	11.231	11.393	11.447	1,540	2,760	4,000	5,350	15,440	.78
KB120ARO	12.000	12.625	12.231	12.393	12.445	1,623	2,853	4,240	5,840	16,860	.85
KB140ARO	14.000	14.625	14.231	14.393	14.439	1,767	3,005	4,670	6,760	19,500	.98
KB160ARO	16.000	16.625	16.231	16.393	16.433	1,907	3,154	5,100	7,710	22,250	1.12
KB180ARO	18.000	18.625	18.231	18.393	18.425	2,038	3,292	5,510	8,660	24,990	1.26
KB200ARO	20.000	20.625	20.231	20.393	20.416	2,162	3,421	5,900	9,610	27,730	1.40

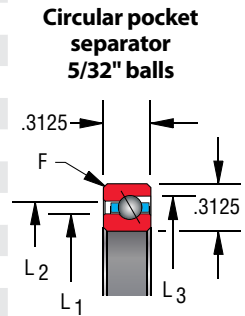

④ F = .040
Bearing corners are normally chamfered

① Capacities listed are not simultaneous. For combined loading see discussion of Bearing Selection and Load Analysis. Dynamic capacities are based upon 1 million revolutions of L10 life. Published capacities do not apply to hybrid series bearings P, X, and Y - contact Kaydon product engineering for values.
 ② Static capacities are non-brinell limits based on rigid support from the shaft and housing.
 ③ ISO Radial ratings are calculated per ISO 281:1990. They are included for comparison only (refer to Page 95).
 ④ "F" is the maximum shaft or housing fillet radius the bearing corners will clear.

CONTACT Kaydon at —
Kaydon Bearings • Muskegon, Michigan 49443
Telephone: 231-755-3741 • Fax: 231-759-4102

Need Service Fast?
1-800-514-3066
www.kaydonbearings.com



Type A – Open Reali-Slim Bearings, ANGULAR CONTACT

KC Series											
KAYDON Bearing Number	Dimensions in Inches					Capacities in Pounds ^①					Approx. Wt. in lbs.
	Size		Land Diameters			Dynamic			Static ^②		
	Bore	Outside Dia.	L ₁	L ₂	C'Bore L ₃	KAYDON Radial	ISO Radial ^③	Thrust	Radial	Thrust	
KC040ARO	4.000	4.750	4.277	4.473	4.554	1,153	2,520	2,770	2,550	7,360	.44
KC042ARO	4.250	5.000	4.527	4.723	4.804	1,194	2,580	2,880	2,710	7,820	.46
KC045ARO	4.500	5.250	4.777	4.973	5.052	1,234	2,637	2,990	2,860	8,270	.49
KC047ARO	4.750	5.500	5.027	5.223	5.302	1,274	2,693	3,100	3,020	8,720	.51
KC050ARO	5.000	5.750	5.277	5.473	5.552	1,313	2,746	3,200	3,180	9,170	.54
KC055ARO	5.500	6.250	5.777	5.973	6.052	1,374	2,820	3,370	3,440	9,920	.58
KC060ARO	6.000	6.750	6.277	6.473	6.550	1,448	2,917	3,580	3,750	10,820	.64
KC065ARO	6.500	7.250	6.777	6.973	7.050	1,519	3,009	3,770	4,060	11,720	.68
KC070ARO	7.000	7.750	7.277	7.473	7.550	1,575	3,071	3,930	4,320	12,470	.74
KC075ARO	7.500	8.250	7.777	7.973	8.048	1,642	3,156	4,120	4,630	13,380	.78
KC080ARO	8.000	8.750	8.277	8.473	8.548	1,708	3,236	4,300	4,950	14,280	.84
KC090ARO	9.000	9.750	9.277	9.473	9.546	1,822	3,366	4,630	5,520	15,930	.98
KC100ARO	10.000	10.750	10.277	10.473	10.544	1,942	3,508	4,970	6,140	17,730	1.04
KC110ARO	11.000	11.750	11.277	11.473	11.542	2,047	3,621	5,280	6,720	19,390	1.14
KC120ARO	12.000	12.750	12.277	12.473	12.540	2,147	3,729	5,570	7,290	21,040	1.23
KC140ARO	14.000	14.750	14.277	14.473	14.535	2,347	3,946	6,170	8,490	24,500	1.43
KC160ARO	16.000	16.750	16.277	16.473	16.529	2,533	4,144	6,730	9,680	27,950	1.63
KC180ARO	18.000	18.750	18.277	18.473	18.523	2,707	4,326	7,280	10,880	31,410	1.83
KC200ARO	20.000	20.750	20.277	20.473	20.517	2,863	4,484	7,780	12,030	34,720	2.03
KC250ARO	25.000	25.750	25.277	25.473	25.500	3,233	4,863	9,010	14,900	43,280	2.52
KC300ARO	30.000	30.750	30.277	30.473	30.484	3,561	5,196	10,160	17,960	51,850	3.02

Circular pocket separator 3/16" balls

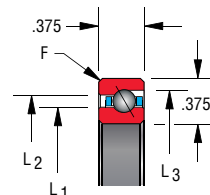

④ F = .040
Bearing corners are normally chamfered

KD Series											
KAYDON Bearing Number	Dimensions in Inches					Capacities in Pounds ^①					Approx. Wt. in lbs.
	Size		Land Diameters			Dynamic			Static ^②		
	Bore	Outside Dia.	L ₁	L ₂	C'Bore L ₃	KAYDON Radial	ISO Radial ^③	Thrust	Radial	Thrust	
KD040ARO	4.000	5.000	4.370	4.630	4.741	1,819	3,708	4,260	3,550	10,260	.80
KD042ARO	4.250	5.250	4.620	4.880	4.991	1,876	3,786	4,420	3,750	10,830	.84
KD045ARO	4.500	5.500	4.870	5.130	5.241	1,931	3,861	4,570	3,950	11,400	.88
KD047ARO	4.750	5.750	5.120	5.380	5.490	1,986	3,934	4,720	4,150	11,970	.93
KD050ARO	5.000	6.000	5.370	5.630	5.740	2,040	4,004	4,870	4,340	12,540	.98
KD055ARO	5.500	6.500	5.870	6.130	6.238	2,145	4,138	5,160	4,740	13,680	1.06
KD060ARO	6.000	7.000	6.370	6.630	6.738	2,247	4,264	5,440	5,130	14,820	1.15
KD065ARO	6.500	7.500	6.870	7.130	7.236	2,346	4,384	5,720	5,530	15,960	1.24
KD070ARO	7.000	8.000	7.370	7.630	7.736	2,442	4,499	5,990	5,920	17,100	1.33
KD075ARO	7.500	8.500	7.870	8.130	8.236	2,536	4,608	6,250	6,320	18,240	1.42
KD080ARO	8.000	9.000	8.370	8.630	8.734	2,627	4,713	6,510	6,710	19,380	1.52
KD090ARO	9.000	10.000	9.370	9.630	9.732	2,803	4,911	7,010	7,500	21,660	1.69
KD100ARO	10.000	11.000	10.370	10.630	10.732	2,972	5,096	7,500	8,290	23,940	1.87
KD110ARO	11.000	12.000	11.370	11.630	11.730	3,133	5,270	7,960	9,080	26,220	2.05
KD120ARO	12.000	13.000	12.370	12.630	12.728	3,288	5,434	8,420	9,870	28,500	2.23
KD140ARO	14.000	15.000	14.370	14.630	14.724	3,582	5,739	9,290	11,450	33,060	2.57
KD160ARO	16.000	17.000	16.370	16.630	16.718	3,856	6,018	10,130	13,030	37,620	2.93
KD180ARO	18.000	19.000	18.370	18.630	18.712	4,113	6,276	10,930	14,610	42,180	3.29
KD200ARO	20.000	21.000	20.370	20.630	20.705	4,356	6,517	11,710	16,190	46,740	3.65
KD210ARO	21.000	22.000	21.370	21.630	21.700	4,472	6,632	12,086	16,981	49,020	3.83
KD250ARO	25.000	26.000	25.370	25.630	25.688	4,908	7,060	13,540	20,140	58,140	4.54
KD300ARO	30.000	31.000	30.370	30.630	30.672	5,397	7,538	15,260	24,090	69,540	5.44

Circular pocket separator 1/4" balls

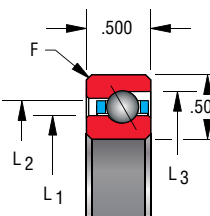

④ F = .060
Bearing corners are normally chamfered

① Capacities listed are not simultaneous. For combined loading see discussion of [Bearing Selection](#) and [Load Analysis](#). Dynamic capacities are based upon 1 million revolutions of L10 life. Published capacities do not apply to hybrid series bearings P, X, and Y - contact Kaydon product engineering for values.
 ② Static capacities are non-brinell limits based on rigid support from the shaft and housing.
 ③ ISO Radial ratings are calculated per ISO 281:1990. They are included for comparison only (refer to [Page 95](#)).
 ④ "F" is the maximum shaft or housing fillet radius the bearing corners will clear.

Type A – Open Real-Slim Bearings, ANGULAR CONTACT

Selection Tables

Section 2

KF Series											
KAYDON Bearing Number	Dimensions in Inches					Capacities in Pounds ^①					Approx. Wt. in lbs.
	Size		Land Diameters			Dynamic			Static ^②		
	Bore	Outside Dia.	L ₁	L ₂	C' Bore L ₃	KAYDON Radial	ISO Radial ^③	Thrust	Radial	Thrust	
KF040ARO	4.000	5.500	4.555	4.945	5.115	3,736	6,809	8,420	6,350	18,340	1.92
KF042ARO	4.250	5.750	4.805	5.195	5.365	3,805	6,891	8,630	6,600	19,050	2.04
KF045ARO	4.500	6.000	5.055	5.445	5.615	3,966	7,134	9,050	7,090	20,460	2.14
KF047ARO	4.750	6.250	5.305	5.695	5.865	4,034	7,207	9,260	7,330	21,160	2.26
KF050ARO	5.000	6.500	5.555	5.945	6.115	4,101	7,279	9,460	7,570	21,870	2.37
KF055ARO	5.500	7.000	6.055	6.445	6.613	4,319	7,566	10,060	8,310	23,980	2.59
KF060ARO	6.000	7.500	6.555	6.945	7.113	4,530	7,835	10,650	9,040	26,100	2.72
KF065ARO	6.500	8.000	7.055	7.445	7.613	4,734	8,088	11,220	9,770	28,220	2.94
KF070ARO	7.000	8.500	7.555	7.945	8.113	4,932	8,329	11,770	10,510	30,330	3.16
KF075ARO	7.500	9.000	8.055	8.445	8.610	5,052	8,432	12,130	11,000	31,740	3.39
KF080ARO	8.000	9.500	8.555	8.945	9.110	5,242	8,655	12,670	11,730	33,860	3.61
KF090ARO	9.000	10.500	9.555	9.945	10.108	5,608	9,073	13,700	13,190	38,090	3.95
KF100ARO	10.000	11.500	10.555	10.945	11.106	5,890	9,353	14,530	14,420	41,620	4.40
KF110ARO	11.000	12.500	11.555	11.945	12.106	6,227	9,720	15,500	15,880	45,850	4.75
KF120ARO	12.000	13.500	12.555	12.945	13.104	6,487	9,969	16,290	17,100	49,380	5.20
KF140ARO	14.000	15.500	14.555	14.945	15.102	7,043	10,523	17,950	19,790	57,140	5.76
KF160ARO	16.000	17.500	16.555	16.945	17.098	7,563	11,030	19,540	22,480	64,890	6.78
KF180ARO	18.000	19.500	18.555	18.945	19.096	8,103	11,573	21,210	25,410	73,360	7.67
KF200ARO	20.000	21.500	20.555	20.945	21.092	8,562	12,006	22,680	28,100	81,120	8.47
KF250ARO	25.000	26.500	25.555	25.945	26.085	9,585	12,954	26,100	34,700	100,200	10.50
KF300ARO	30.000	31.500	30.555	30.945	31.075	10,533	13,848	29,430	41,540	119,900	12.50
KF350ARO	35.000	36.500	35.555	35.945	36.064	11,382	14,653	32,580	48,380	139,700	14.60
KF400ARO	40.000	41.500	40.555	40.945	41.054	12,147	15,387	35,580	55,220	159,400	16.60

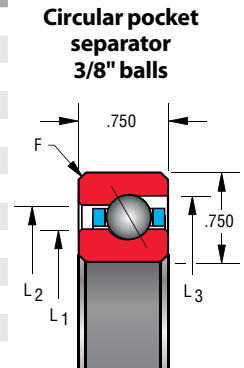

④ F = .080
 Bearing corners are normally chamfered

KG Series											
KAYDON Bearing Number	Dimensions in Inches					Capacities in Pounds ^①					Approx. Wt. in lbs.
	Size		Land Diameters			Dynamic			Static ^②		
	Bore	Outside Dia.	L ₁	L ₂	C' Bore L ₃	KAYDON Radial	ISO Radial ^③	Thrust	Radial	Thrust	
KG040ARO	4.000	6.000	4.742	5.258	5.491	6,281	10,167	13,630	9,480	27,360	3.61
KG042ARO	4.250	6.250	4.992	5.508	5.741	6,438	10,384	14,090	9,950	28,730	3.83
KG045ARO	4.500	6.500	5.242	5.758	5.989	6,562	10,592	14,530	10,430	30,100	3.95
KG047ARO	4.750	6.750	5.492	6.008	6.239	6,745	10,792	14,970	10,900	31,460	4.17
KG050ARO	5.000	7.000	5.742	6.258	6.489	6,897	10,985	15,400	11,370	32,830	4.42
KG055ARO	5.500	7.500	6.242	6.758	6.989	7,192	11,352	16,240	12,320	35,570	4.73
KG060ARO	6.000	8.000	6.742	7.258	7.489	7,480	11,697	17,060	13,270	38,300	5.07
KG065ARO	6.500	8.500	7.242	7.758	7.987	7,761	12,023	17,870	14,220	41,040	5.41
KG070ARO	7.000	9.000	7.742	8.258	8.487	8,035	12,333	18,650	15,160	43,780	5.87
KG075ARO	7.500	9.500	8.242	8.758	8.987	8,303	12,629	19,420	16,110	46,510	6.20
KG080ARO	8.000	10.000	8.742	9.258	9.485	8,566	12,912	20,180	17,060	49,250	6.54
KG090ARO	9.000	11.000	9.742	10.258	10.485	9,073	13,446	21,640	18,960	54,720	7.22
KG100ARO	10.000	12.000	10.742	11.258	11.483	9,561	13,942	23,060	20,850	60,190	8.00
KG110ARO	11.000	13.000	11.742	12.258	12.481	10,027	14,409	24,440	22,750	65,660	8.68
KG120ARO	12.000	14.000	12.742	13.258	13.481	10,481	14,849	25,780	24,640	71,140	9.47
KG140ARO	14.000	16.000	14.742	15.258	15.478	11,338	15,665	28,360	28,430	82,080	10.90
KG160ARO	16.000	18.000	16.742	17.258	17.474	12,142	16,411	30,830	32,220	93,020	12.40
KG180ARO	18.000	20.000	18.742	19.258	19.472	12,898	17,101	33,200	36,020	104,000	13.80
KG200ARO	20.000	22.000	20.742	21.258	21.468	13,612	17,745	35,490	39,810	114,900	15.20
KG220ARO	22.000	24.000	22.742	23.258	23.468	14,290	18,351	37,712	43,598	125,856	16.63
KG250ARO	25.000	27.000	25.742	26.258	26.461	15,239	19,198	40,920	49,280	142,300	18.80
KG300ARO	30.000	32.000	30.742	31.258	31.451	16,687	20,480	46,020	58,760	169,600	22.50
KG350ARO	35.000	37.000	35.742	36.258	36.440	17,982	21,636	50,840	68,240	197,000	26.20
KG400ARO	40.000	42.000	40.742	41.258	41.430	19,153	22,693	55,440	77,720	224,400	29.80

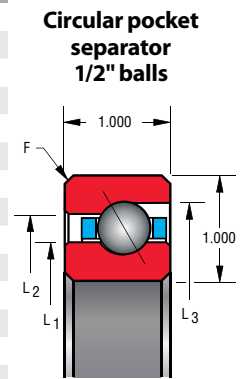

④ F = .080
 Bearing corners are normally chamfered

① Capacities listed are not simultaneous. For combined loading see discussion of Bearing Selection and Load Analysis. Dynamic capacities are based upon 1 million revolutions of L10 life. Published capacities do not apply to hybrid series bearings P, X, and Y - contact Kaydon product engineering for values.
 ② Static capacities are non-brinell limits based on rigid support from the shaft and housing.
 ③ ISO Radial ratings are calculated per ISO 281:1990. They are included for comparison only (refer to Page 95).
 ④ "F" is the maximum shaft or housing fillet radius the bearing corners will clear.

Open Reali-Slim Bearing Selections

Type C – RADIAL CONTACT

A Conrad assembled bearing designed primarily for application of radial load—deep ball grooves also permit application of

thrust load in either direction – often used in conjunction with another bearing.

KAA Series								
KAYDON Bearing Number	Dimensions in Inches				Capacities in Pounds ^①			Approx. Wt. in lbs.
	Size		Land Diameters		Dynamic		Static ^②	
	Bore	Outside Dia.	L ₁	L ₂	KAYDON Radial	ISO Radial ^③	Radial	
KAA10CLO	1.000	1.375	1.140	1.235	188	558	290	.026
KAA15CLO	1.500	1.875	1.640	1.735	225	632	400	.039
KAA17CLO	1.750	2.125	1.890	1.985	242	663	460	.045

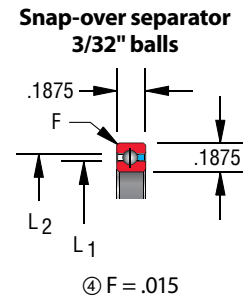

KA Series								
KAYDON Bearing Number	Dimensions in Inches				Capacities in Pounds ^①			Approx. Wt. in lbs.
	Size		Land Diameters		Dynamic		Static ^②	
	Bore	Outside Dia.	L ₁	L ₂	KAYDON Radial	ISO Radial ^③	Radial	
KA020CP0	2.000	2.500	2.186	2.314	393	1,012	680	.10
KA025CP0	2.500	3.000	2.686	2.814	442	1,094	830	.13
KA030CP0	3.000	3.500	3.186	3.314	487	1,166	990	.15
KA035CP0	3.500	4.000	3.686	3.814	530	1,230	1,140	.18
KA040CP0	4.000	4.500	4.186	4.314	571	1,289	1,290	.19
KA042CP0	4.250	4.750	4.436	4.564	591	1,317	1,370	.20
KA045CP0	4.500	5.000	4.686	4.814	610	1,344	1,440	.22
KA047CP0	4.750	5.250	4.936	5.064	629	1,369	1,520	.23
KA050CP0	5.000	5.500	5.186	5.314	648	1,394	1,590	.24
KA055CP0	5.500	6.000	5.686	5.814	685	1,442	1,750	.25
KA060CP0	6.000	6.500	6.186	6.314	720	1,487	1,900	.28
KA065CP0	6.500	7.000	6.686	6.814	754	1,530	2,050	.30
KA070CP0	7.000	7.500	7.186	7.314	787	1,571	2,200	.31
KA075CP0	7.500	8.000	7.686	7.814	820	1,610	2,350	.34
KA080CP0	8.000	8.500	8.186	8.314	851	1,647	2,500	.38
KA090CP0	9.000	9.500	9.186	9.314	912	1,718	2,810	.44
KA100CP0	10.000	10.500	10.186	10.314	969	1,784	3,110	.50
KA110CP0	11.000	11.500	11.186	11.314	1,025	1,846	3,410	.52
KA120CP0	12.000	12.500	12.186	12.314	1,078	1,904	3,720	.56

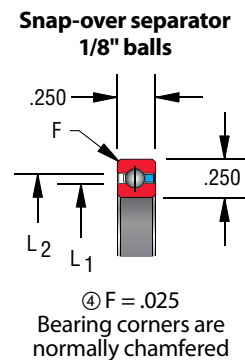

① Capacities listed are not simultaneous. For combined loading see discussion of [Bearing Selection](#) and [Load Analysis](#). Dynamic capacities are based upon 1 million revolutions of L10 life. Published capacities do not apply to hybrid series bearings P, X, and Y - contact Kaydon product engineering for values.
 ② Static capacities are non-brinell limits based on rigid support from the shaft and housing.
 ③ ISO Radial ratings are calculated per ISO 281:1990. They are included for comparison only (refer to [Page 95](#)).
 ④ "F" is the maximum shaft or housing fillet radius the bearing corners will clear.

Type C – Open Real-Slim Bearings, RADIAL CONTACT

Selection Tables

Section 2

KB Series								
KAYDON Bearing Number	Dimensions in Inches				Capacities in Pounds ^①			Approx. Wt. in lbs.
	Size		Land Diameters		Dynamic		Static ^②	
	Bore	Outside Dia.	L ₁	L ₂	KAYDON Radial	ISO Radial ^③	Radial	
KB020CP0	2.000	2.625	2.231	2.393	577	1,431	930	.16
KB025CP0	2.500	3.125	2.731	2.893	644	1,549	1,140	.20
KB030CP0	3.000	3.625	3.231	3.393	707	1,651	1,340	.24
KB035CP0	3.500	4.125	3.731	3.893	767	1,743	1,540	.27
KB040CP0	4.000	4.625	4.231	4.393	825	1,827	1,750	.30
KB042CP0	4.250	4.875	4.481	4.643	846	1,853	1,830	.31
KB045CP0	4.500	5.125	4.731	4.893	880	1,904	1,950	.33
KB047CP0	4.750	5.375	4.981	5.143	901	1,928	2,030	.34
KB050CP0	5.000	5.625	5.231	5.393	933	1,976	2,150	.38
KB055CP0	5.500	6.125	5.731	5.893	984	2,044	2,360	.41
KB060CP0	6.000	6.625	6.231	6.393	1,034	2,108	2,560	.44
KB065CP0	6.500	7.125	6.731	6.893	1,082	2,168	2,760	.47
KB070CP0	7.000	7.625	7.231	7.393	1,129	2,226	2,970	.50
KB075CP0	7.500	8.125	7.731	7.893	1,175	2,281	3,170	.53
KB080CP0	8.000	8.625	8.231	8.393	1,219	2,334	3,370	.57
KB090CP0	9.000	9.625	9.231	9.393	1,304	2,434	3,780	.66
KB100CP0	10.000	10.625	10.231	10.393	1,386	2,527	4,190	.73
KB110CP0	11.000	11.625	11.231	11.393	1,464	2,615	4,590	.75
KB120CP0	12.000	12.625	12.231	12.393	1,539	2,698	5,000	.83
KB140CP0	14.000	14.625	14.231	14.393	1,680	2,851	5,810	1.05
KB160CP0	16.000	16.625	16.231	16.393	1,812	2,991	6,620	1.20
KB180CP0	18.000	18.625	18.231	18.393	1,936	3,121	7,440	1.35
KB200CP0	20.000	20.625	20.231	20.393	2,053	3,242	8,250	1.50

**Snap-over separator
5/32" balls**

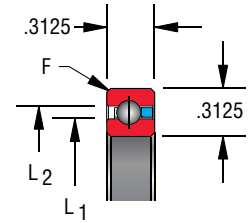

④ F = .040
Bearing corners are normally chamfered

- ① Capacities listed are not simultaneous. For combined loading see discussion of [Bearing Selection](#) and [Load Analysis](#). Dynamic capacities are based upon 1 million revolutions of L10 life. Published capacities do not apply to hybrid series bearings P, X, and Y - contact Kaydon product engineering for values.
- ② Static capacities are non-brinell limits based on rigid support from the shaft and housing.
- ③ ISO Radial ratings are calculated per ISO 281:1990. They are included for comparison only (refer to [Page 95](#)).
- ④ "F" is the maximum shaft or housing fillet radius the bearing corners will clear.

CONTACT Kaydon at —
Kaydon Bearings • Muskegon, Michigan 49443
Telephone: 231-755-3741 • Fax: 231-759-4102

Need Service Fast?
1-800-514-3066
www.kaydonbearings.com



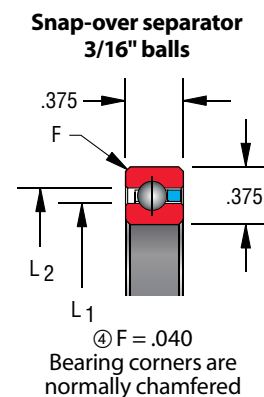

Type C – Open Reali-Slim Bearings, RADIAL CONTACT

KC Series								
KAYDON Bearing Number	Dimensions in Inches				Capacities in Pounds ^①			Approx. Wt. in lbs.
	Size		Land Diameters		Dynamic		Static ^②	
	Bore	Outside Dia.	L ₁	L ₂	KAYDON Radial	ISO Radial ^③	Radial	
KC040CP0	4.000	4.750	4.277	4.473	1,073	2,321	2,100	.45
KC042CP0	4.250	5.000	4.527	4.723	1,108	2,370	2,220	.47
KC045CP0	4.500	5.250	4.777	4.973	1,143	2,418	2,340	.48
KC047CP0	4.750	5.500	5.027	5.223	1,176	2,464	2,460	.50
KC050CP0	5.000	5.750	5.277	5.473	1,209	2,509	2,590	.58
KC055CP0	5.500	6.250	5.777	5.973	1,274	2,594	2,830	.59
KC060CP0	6.000	6.750	6.277	6.473	1,337	2,674	3,070	.63
KC065CP0	6.500	7.250	6.777	6.973	1,397	2,751	3,310	.68
KC070CP0	7.000	7.750	7.277	7.473	1,457	2,823	3,550	.73
KC075CP0	7.500	8.250	7.777	7.973	1,514	2,893	3,790	.78
KC080CP0	8.000	8.750	8.277	8.473	1,570	2,960	4,030	.84
KC090CP0	9.000	9.750	9.277	9.473	1,678	3,085	4,510	.94
KC100CP0	10.000	10.750	10.277	10.473	1,781	3,203	4,990	1.06
KC110CP0	11.000	11.750	11.277	11.473	1,879	3,313	5,470	1.16
KC120CP0	12.000	12.750	12.277	12.473	1,974	3,417	5,950	1.25
KC140CP0	14.000	14.750	14.277	14.473	2,154	3,611	6,910	1.52
KC160CP0	16.000	16.750	16.277	16.473	2,321	3,787	7,880	1.73
KC180CP0	18.000	18.750	18.277	18.473	2,478	3,951	8,840	1.94
KC200CP0	20.000	20.750	20.277	20.473	2,626	4,104	9,800	2.16
KC250CP0	25.000	25.750	25.277	25.473	2,962	4,447	12,200	2.69
KC300CP0	30.000	30.750	30.277	30.473	3,260	4,750	14,610	3.21

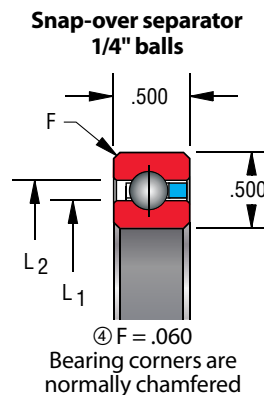

KD Series								
KAYDON Bearing Number	Dimensions in Inches				Capacities in Pounds ^①			Approx. Wt. in lbs.
	Size		Land Diameters		Dynamic		Static ^②	
	Bore	Outside Dia.	L ₁	L ₂	KAYDON Radial	ISO Radial ^③	Radial	
KD040CP0	4.000	5.000	4.370	4.630	1,755	3,523	3,080	.78
KD042CP0	4.250	5.250	4.620	4.880	1,787	3,556	3,190	.83
KD045CP0	4.500	5.500	4.870	5.130	1,861	3,671	3,420	.88
KD047CP0	4.750	5.750	5.120	5.380	1,892	3,701	3,530	.94
KD050CP0	5.000	6.000	5.370	5.630	1,964	3,808	3,760	1.00
KD055CP0	5.500	6.500	5.870	6.130	2,063	3,937	4,100	1.06
KD060CP0	6.000	7.000	6.370	6.630	2,160	4,059	4,450	1.16
KD065CP0	6.500	7.500	6.870	7.130	2,254	4,174	4,790	1.22
KD070CP0	7.000	8.000	7.370	7.630	2,345	4,284	5,130	1.31
KD075CP0	7.500	8.500	7.870	8.130	2,434	4,388	5,470	1.41
KD080CP0	8.000	9.000	8.370	8.630	2,520	4,489	5,810	1.53
KD090CP0	9.000	10.000	9.370	9.630	2,688	4,678	6,500	1.72
KD100CP0	10.000	11.000	10.370	10.630	2,847	4,855	7,180	1.88
KD110CP0	11.000	12.000	11.370	11.630	3,000	5,021	7,870	2.06
KD120CP0	12.000	13.000	12.370	12.630	3,148	5,178	8,550	2.25
KD140CP0	14.000	15.000	14.370	14.630	3,427	5,469	9,920	2.73
KD160CP0	16.000	17.000	16.370	16.630	3,688	5,736	11,290	3.10
KD180CP0	18.000	19.000	18.370	18.630	3,933	5,982	12,650	3.48
KD200CP0	20.000	21.000	20.370	20.630	4,164	6,212	14,020	3.85
KD210CP0	21.000	22.000	21.370	21.630	4,274	6,321	14,706	4.04
KD250CP0	25.000	26.000	25.370	25.630	4,689	6,729	17,440	4.79
KD300CP0	30.000	31.000	30.370	30.630	5,153	7,186	20,860	5.73



① Capacities listed are not simultaneous. For combined loading see discussion of [Bearing Selection](#) and [Load Analysis](#). Dynamic capacities are based upon 1 million revolutions of L10 life. Published capacities do not apply to hybrid series bearings P, X, and Y - contact Kaydon product engineering for values.

② Static capacities are non-brinell limits based on rigid support from the shaft and housing.

③ ISO Radial ratings are calculated per ISO 281:1990. They are included for comparison only (refer to [Page 95](#)).

④ "F" is the maximum shaft or housing fillet radius the bearing corners will clear.

Type C – Open Real-Slim Bearings, RADIAL CONTACT

Selection Tables

Section 2

KF Series								
KAYDON Bearing Number	Dimensions in Inches				Capacities in Pounds ^①			Approx. Wt. in lbs.
	Size		Land Diameters		Dynamic		Static ^②	
	Bore	Outside Dia.	L ₁	L ₂	KAYDON Radial	ISO Radial ^③	Radial	
KF040CP0	4.000	5.500	4.555	4.945	3,559	6,334	5,360	1.9
KF042CP0	4.250	5.750	4.805	5.195	3,655	6,472	5,640	2.0
KF045CP0	4.500	6.000	5.055	5.445	3,750	6,605	5,930	2.1
KF047CP0	4.750	6.250	5.305	5.695	3,843	6,732	6,210	2.2
KF050CP0	5.000	6.500	5.555	5.945	3,936	6,855	6,490	2.3
KF055CP0	5.500	7.000	6.055	6.445	4,116	7,089	7,050	2.5
KF060CP0	6.000	7.500	6.555	6.945	4,291	7,308	7,620	2.7
KF065CP0	6.500	8.000	7.055	7.445	4,461	7,516	8,180	2.9
KF070CP0	7.000	8.500	7.555	7.945	4,628	7,713	8,750	3.2
KF075CP0	7.500	9.000	8.055	8.445	4,791	7,901	9,310	3.4
KF080CP0	8.000	9.500	8.555	8.945	4,949	8,081	9,880	3.5
KF090CP0	9.000	10.500	9.555	9.945	5,256	8,421	11,000	3.9
KF100CP0	10.000	11.500	10.555	10.945	5,550	8,737	12,130	4.3
KF110CP0	11.000	12.500	11.555	11.945	5,833	9,033	13,260	4.8
KF120CP0	12.000	13.500	12.555	12.945	6,105	9,313	14,390	5.2
KF140CP0	14.000	15.500	14.555	14.945	6,620	9,832	16,650	6.0
KF160CP0	16.000	17.500	16.555	16.945	7,104	10,306	18,900	7.1
KF180CP0	18.000	19.500	18.555	18.945	7,557	10,744	21,160	7.9
KF200CP0	20.000	21.500	20.555	20.945	7,986	11,153	23,420	8.9
KF250CP0	25.000	26.500	25.555	25.945	8,963	12,074	29,060	10.9
KF300CP0	30.000	31.500	30.555	30.945	9,828	12,887	34,700	13.0
KF350CP0	35.000	36.500	35.555	35.945	10,603	13,620	40,350	15.1
KF400CP0	40.000	41.500	40.555	40.945	11,302	14,289	45,990	17.2

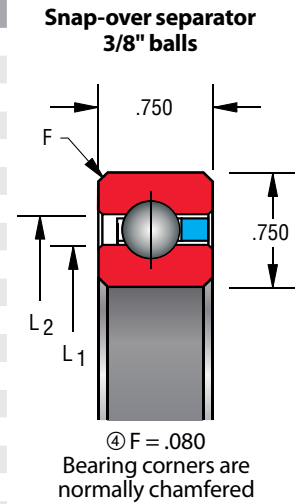

KG Series								
KAYDON Bearing Number	Dimensions in Inches				Capacities in Pounds ^①			Approx. Wt. in lbs.
	Size		Land Diameters		Dynamic		Static ^②	
	Bore	Outside Dia.	L ₁	L ₂	KAYDON Radial	ISO Radial ^③	Radial	
KG040CP0	4.000	6.000	4.742	5.258	6,115	9,579	8,210	3.6
KG042CP0	4.250	6.250	4.992	5.508	6,061	9,481	8,210	3.8
KG045CP0	4.500	6.500	5.242	5.758	6,227	9,797	8,760	4.0
KG047CP0	4.750	6.750	5.492	6.008	6,487	10,099	9,300	4.1
KG050CP0	5.000	7.000	5.742	6.258	6,691	10,388	9,850	4.3
KG055CP0	5.500	7.500	6.242	6.758	6,850	10,563	10,400	4.7
KG060CP0	6.000	8.000	6.742	7.258	7,241	11,085	11,490	5.1
KG065CP0	6.500	8.500	7.242	7.758	7,393	11,234	12,040	5.4
KG070CP0	7.000	9.000	7.742	8.258	7,764	11,705	13,130	5.8
KG075CP0	7.500	9.500	8.242	8.758	7,911	11,835	13,680	6.1
KG080CP0	8.000	10.000	8.742	9.258	8,265	12,266	14,770	6.5
KG090CP0	9.000	11.000	9.742	10.258	8,743	12,782	16,420	7.2
KG100CP0	10.000	12.000	10.742	11.258	9,204	13,261	18,060	7.9
KG110CP0	11.000	13.000	11.742	12.258	9,648	13,710	19,700	8.6
KG120CP0	12.000	14.000	12.742	13.258	10,074	14,133	21,340	9.3
KG140CP0	14.000	16.000	14.742	15.258	10,886	14,916	24,620	10.8
KG160CP0	16.000	18.000	16.742	17.258	11,648	15,631	27,910	12.3
KG180CP0	18.000	20.000	18.742	19.258	12,367	16,291	31,190	13.7
KG200CP0	20.000	22.000	20.742	21.258	13,044	16,907	34,470	15.8
KG220CP0	22.000	24.000	22.742	23.258	13,685	17,486	37,757	16.8
KG250CP0	25.000	27.000	25.742	26.258	14,591	18,295	42,680	19.5
KG300CP0	30.000	32.000	30.742	31.258	15,963	19,519	50,890	23.3
KG350CP0	35.000	37.000	35.742	36.258	17,195	20,622	59,100	27.1
KG400CP0	40.000	42.000	40.742	41.258	18,307	21,630	67,310	30.8

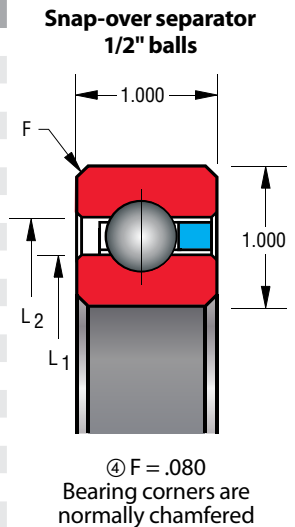

① Capacities listed are not simultaneous. For combined loading see discussion of [Bearing Selection](#) and [Load Analysis](#). Dynamic capacities are based upon 1 million revolutions of L10 life. Published capacities do not apply to hybrid series bearings P, X, and Y - contact Kaydon product engineering for values.

② Static capacities are non-brinell limits based on rigid support from the shaft and housing.

③ ISO Radial ratings are calculated per ISO 281:1990. They are included for comparison only (refer to [Page 95](#)).

④ "F" is the maximum shaft or housing fillet radius the bearing corners will clear.

Open Reali-Slim Bearing Selections

Type X – FOUR-POINT CONTACT

A Conrad assembled bearing designed for applications involving multiple loads. Unique internal geometry permits application of radial load, thrust load in either direction, and moment load,

individually or in any combination. A single four-point contact bearing may replace two bearings in many applications.

KAA Series												
KAYDON Bearing Number	Dimensions in Inches				Capacities ^①						Approx. Wt. in lbs.	
	Size		Land Diameters		Dynamic			Static ^②				
	Bore	Outside Dia.	L ₁	L ₂	Radial (lbs)	Thrust (lbs)	Moment (in-lbs)	Radial (lbs)	Thrust (lbs)	Moment (in-lbs)		
KAA10XLO	1.000	1.375	1.140	1.235	247	370	110	290	730	170	.026	
KAA15XLO	1.500	1.875	1.640	1.735	296	460	187	400	1,000	340	.039	
KAA17XLO	1.750	2.125	1.890	1.985	319	500	232	460	1,140	440	.045	

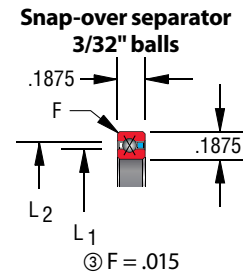

KA Series												
KAYDON Bearing Number	Dimensions in Inches				Capacities ^①						Approx. Wt. in lbs.	
	Size		Land Diameters		Dynamic			Static ^②				
	Bore	Outside Dia.	L ₁	L ₂	Radial (lbs)	Thrust (lbs)	Moment (in-lbs)	Radial (lbs)	Thrust (lbs)	Moment (in-lbs)		
KA020XP0	2.000	2.500	2.186	2.314	514	790	434	680	1,710	770	.10	
KA025XP0	2.500	3.000	2.686	2.814	583	910	601	830	2,090	1,150	.13	
KA027XP0	2.750	3.250	2.936	3.064	614	960	690	910	2,275	1,365	.14	
KA030XP0	3.000	3.500	3.186	3.314	643	1,010	785	990	2,470	1,600	.15	
KA035XP0	3.500	4.000	3.686	3.814	701	1,110	986	1,140	2,850	2,130	.18	
KA040XP0	4.000	4.500	4.186	4.314	756	1,210	1,205	1,290	3,220	2,740	.19	
KA042XP0	4.250	4.750	4.436	4.564	783	1,260	1,321	1,370	3,410	3,070	.20	
KA045XP0	4.500	5.000	4.686	4.814	809	1,310	1,441	1,440	3,600	3,420	.22	
KA047XP0	4.750	5.250	4.936	5.064	834	1,350	1,565	1,520	3,790	3,790	.23	
KA050XP0	5.000	5.500	5.186	5.314	859	1,400	1,693	1,590	3,980	4,180	.24	
KA055XP0	5.500	6.000	5.686	5.814	908	1,480	1,959	1,750	4,360	5,020	.25	
KA060XP0	6.000	6.500	6.186	6.314	955	1,570	2,240	1,900	4,740	5,930	.28	
KA065XP0	6.500	7.000	6.686	6.814	1,001	1,650	2,535	2,050	5,120	6,910	.30	
KA070XP0	7.000	7.500	7.186	7.314	1,046	1,730	2,844	2,200	5,500	7,980	.31	
KA075XP0	7.500	8.000	7.686	7.814	1,089	1,810	3,165	2,350	5,880	9,120	.34	
KA080XP0	8.000	8.500	8.186	8.314	1,131	1,890	3,499	2,500	6,260	10,330	.38	
KA090XP0	9.000	9.500	9.186	9.314	1,212	2,040	4,204	2,810	7,020	12,990	.44	
KA100XP0	10.000	10.500	10.186	10.314	1,289	2,180	4,956	3,110	7,780	15,940	.50	
KA110XP0	11.000	11.500	11.186	11.314	1,362	2,320	5,750	3,410	8,540	19,210	.52	
KA120XP0	12.000	12.500	12.186	12.314	1,433	2,450	6,587	3,720	9,300	22,770	.56	

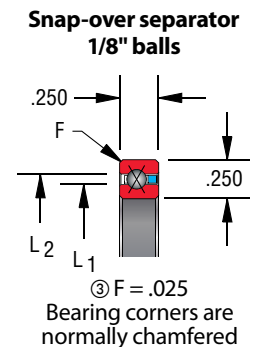

① Capacities listed are not simultaneous. For combined loading see discussion of [Bearing Selection](#) and [Load Analysis](#). Dynamic capacities are based upon 1 million revolutions of L10 life. Published capacities do not apply to hybrid series bearings P, X, and Y - contact Kaydon product engineering for values.

② Static capacities are non-brinell limits based on rigid support from the shaft and housing.

③ "F" is the maximum shaft or housing fillet radius the bearing corners will clear.

Type X – Open Real-Slim Bearings, FOUR-POINT CONTACT

Selection Tables

Section 2

KB Series											
KAYDON Bearing Number	Dimensions in Inches				Capacities ^①						Approx. Wt. in lbs.
	Size		Land Diameters		Dynamic			Static ^②			
	Bore	Outside Dia.	L ₁	L ₂	Radial (lbs)	Thrust (lbs)	Moment (in-lbs)	Radial (lbs)	Thrust (lbs)	Moment (in-lbs)	
KB020XP0	2.000	2.625	2.231	2.393	758	1,130	658	930	2,340	1,080	.16
KB025XP0	2.500	3.125	2.731	2.893	848	1,290	895	1,140	2,840	1,600	.19
KB030XP0	3.000	3.625	3.231	3.393	933	1,440	1,159	1,340	3,350	2,220	.24
KB035XP0	3.500	4.125	3.731	3.893	1,014	1,590	1,450	1,540	3,860	2,940	.27
KB040XP0	4.000	4.625	4.231	4.393	1,091	1,720	1,764	1,750	4,370	3,770	.30
KB042XP0	4.250	4.875	4.481	4.643	1,120	1,780	1,917	1,830	4,570	4,170	.31
KB045XP0	4.500	5.125	4.731	4.893	1,165	1,850	2,103	1,950	4,880	4,690	.33
KB047XP0	4.750	5.375	4.981	5.143	1,193	1,900	2,265	2,030	5,080	5,140	.34
KB050XP0	5.000	5.625	5.231	5.393	1,236	1,980	2,463	2,150	5,380	5,720	.38
KB055XP0	5.500	6.125	5.731	5.893	1,304	2,100	2,844	2,360	5,890	6,850	.41
KB060XP0	6.000	6.625	6.231	6.393	1,371	2,220	3,247	2,560	6,400	8,080	.44
KB065XP0	6.500	7.125	6.731	6.893	1,435	2,340	3,668	2,760	6,910	9,410	.47
KB070XP0	7.000	7.625	7.231	7.393	1,498	2,450	4,109	2,970	7,420	10,850	.50
KB075XP0	7.500	8.125	7.731	7.893	1,559	2,560	4,568	3,170	7,920	12,380	.53
KB080XP0	8.000	8.625	8.231	8.393	1,618	2,670	5,045	3,370	8,430	14,020	.57
KB090XP0	9.000	9.625	9.231	9.393	1,732	2,880	6,050	3,780	9,450	17,600	.66
KB100XP0	10.000	10.625	10.231	10.393	1,841	3,080	7,121	4,190	10,460	21,580	.73
KB110XP0	11.000	11.625	11.231	11.393	1,945	3,280	8,254	4,590	11,480	25,970	.75
KB120XP0	12.000	12.625	12.231	12.393	2,045	3,470	9,446	5,000	12,500	30,770	.83
KB140XP0	14.000	14.625	14.231	14.393	2,234	3,840	11,994	5,810	14,530	41,580	1.05
KB160XP0	16.000	16.625	16.231	16.393	2,410	4,190	14,750	6,620	16,560	54,020	1.20
KB180XP0	18.000	18.625	18.231	18.393	2,576	4,520	17,694	7,440	18,590	68,090	1.35
KB200XP0	20.000	20.625	20.231	20.393	2,731	4,850	20,813	8,250	20,620	83,780	1.50

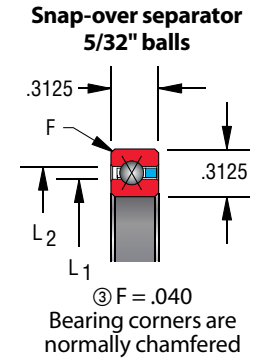

① Capacities listed are not simultaneous. For combined loading see discussion of [Bearing Selection](#) and [Load Analysis](#). Dynamic capacities are based upon 1 million revolutions of L10 life. Published capacities do not apply to hybrid series bearings P, X, and Y - contact Kaydon product engineering for values.

② Static capacities are non-brinell limits based on rigid support from the shaft and housing.

③ "F" is the maximum shaft or housing fillet radius the bearing corners will clear.

CONTACT Kaydon at —
Kaydon Bearings • Muskegon, Michigan 49443
Telephone: 231-755-3741 • Fax: 231-759-4102

Need Service Fast?
1-800-514-3066
www.kaydonbearings.com

Type X – Open Reali-Slim Bearings, FOUR-POINT CONTACT

KC Series											
KAYDON Bearing Number	Dimensions in Inches				Capacities ^①						Approx. Wt. in lbs.
	Size		Land Diameters		Dynamic			Static ^②			
	Bore	Outside Dia.	L ₁	L ₂	Radial (lbs)	Thrust (lbs)	Moment (in-lbs)	Radial (lbs)	Thrust (lbs)	Moment (in-lbs)	
KC040XP0	4.000	4.750	4.277	4.473	1,417	2,210	2,326	2,100	5,260	4,600	.45
KC042XP0	4.250	5.000	4.527	4.723	1,464	2,290	2,541	2,220	5,560	5,140	.47
KC045XP0	4.500	5.250	4.777	4.973	1,510	2,380	2,762	2,340	5,860	5,710	.48
KC047XP0	4.750	5.500	5.027	5.223	1,556	2,460	2,991	2,460	6,160	6,320	.50
KC050XP0	5.000	5.750	5.277	5.473	1,600	2,540	3,226	2,590	6,460	6,950	.58
KC055XP0	5.500	6.250	5.777	5.973	1,687	2,690	3,717	2,830	7,060	8,300	.59
KC060XP0	6.000	6.750	6.277	6.473	1,770	2,840	4,234	3,070	7,660	9,770	.63
KC065XP0	6.500	7.250	6.777	6.973	1,851	2,990	4,775	3,310	8,270	11,370	.68
KC070XP0	7.000	7.750	7.277	7.473	1,931	3,130	5,341	3,550	8,870	13,080	.73
KC075XP0	7.500	8.250	7.777	7.973	2,007	3,270	5,930	3,790	9,470	14,910	.78
KC080XP0	8.000	8.750	8.277	8.473	2,082	3,410	6,542	4,030	10,070	16,870	.84
KC090XP0	9.000	9.750	9.277	9.473	2,226	3,670	7,830	4,510	11,270	21,130	.94
KC100XP0	10.000	10.750	10.277	10.473	2,364	3,930	9,201	4,990	12,470	25,880	1.06
KC110XP0	11.000	11.750	11.277	11.473	2,496	4,180	10,651	5,470	13,680	31,110	1.16
KC120XP0	12.000	12.750	12.277	12.473	2,622	4,420	12,174	5,950	14,880	36,830	1.25
KC140XP0	14.000	14.750	14.277	14.473	2,862	4,890	15,434	6,910	17,280	49,690	1.52
KC160XP0	16.000	16.750	16.277	16.473	3,086	5,330	18,955	7,880	19,690	64,480	1.73
KC180XP0	18.000	18.750	18.277	18.473	3,295	5,760	22,712	8,840	22,090	81,190	1.94
KC200XP0	20.000	20.750	20.277	20.473	3,492	6,170	26,695	9,800	24,500	99,830	2.16
KC250XP0	25.000	25.750	25.277	25.473	3,941	7,140	37,518	12,200	30,510	154,800	2.69
KC300XP0	30.000	30.750	30.277	30.473	4,338	8,050	49,436	14,610	36,520	221,900	3.21

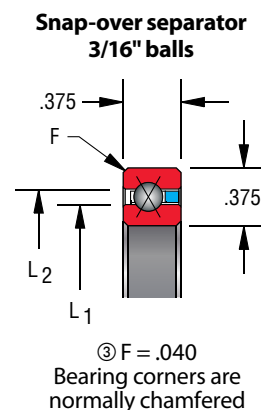

KD Series											
KAYDON Bearing Number	Dimensions in Inches				Capacities ^①						Approx. Wt. in lbs.
	Size		Land Diameters		Dynamic			Static ^②			
	Bore	Outside Dia.	L ₁	L ₂	Radial (lbs)	Thrust (lbs)	Moment (in-lbs)	Radial (lbs)	Thrust (lbs)	Moment (in-lbs)	
KD040XP0	4.000	5.000	4.370	4.630	2,311	3,520	3,901	3,080	7,700	6,930	.78
KD042XP0	4.250	5.250	4.620	4.880	2,355	3,600	4,196	3,190	7,980	7,580	.83
KD045XP0	4.500	5.500	4.870	5.130	2,454	3,770	4,602	3,420	8,550	8,550	.88
KD047XP0	4.750	5.750	5.120	5.380	2,496	3,860	4,916	3,530	8,840	9,280	.94
KD050XP0	5.000	6.000	5.370	5.630	2,592	4,020	5,348	3,760	9,410	10,350	1.00
KD055XP0	5.500	6.500	5.870	6.130	2,725	4,260	6,134	4,100	10,260	12,310	1.06
KD060XP0	6.000	7.000	6.370	6.630	2,855	4,490	6,961	4,450	11,120	14,450	1.16
KD065XP0	6.500	7.500	6.870	7.130	2,980	4,720	7,826	4,790	11,970	16,760	1.22
KD070XP0	7.000	8.000	7.370	7.630	3,103	4,940	8,730	5,130	12,830	19,240	1.31
KD075XP0	7.500	8.500	7.870	8.130	3,222	5,160	9,669	5,470	13,680	21,890	1.41
KD080XP0	8.000	9.000	8.370	8.630	3,338	5,370	10,643	5,810	14,540	24,710	1.53
KD090XP0	9.000	10.000	9.370	9.630	3,561	5,790	12,693	6,500	16,250	30,870	1.72
KD100XP0	10.000	11.000	10.370	10.630	3,776	6,190	14,872	7,180	17,960	37,710	1.88
KD110XP0	11.000	12.000	11.370	11.630	3,981	6,570	17,173	7,870	19,670	45,230	2.06
KD120XP0	12.000	13.000	12.370	12.630	4,178	6,950	19,590	8,550	21,380	53,440	2.25
KD140XP0	14.000	15.000	14.370	14.630	4,551	7,670	24,755	9,920	24,800	71,910	2.73
KD160XP0	16.000	17.000	16.370	16.630	4,899	8,360	30,325	11,290	28,220	93,110	3.10
KD180XP0	18.000	19.000	18.370	18.630	5,226	9,030	36,268	12,650	31,640	117,000	3.48
KD200XP0	20.000	21.000	20.370	20.630	5,534	9,670	42,561	14,020	35,060	143,700	3.85
KD210XP0	21.000	22.000	21.370	21.630	5,682	9,980	45,826	14,710	36,770	158,100	4.04
KD250XP0	25.000	26.000	25.370	25.630	6,235	11,180	59,649	17,440	43,610	222,400	4.79
KD300XP0	30.000	31.000	30.370	30.630	6,856	12,600	78,447	20,860	52,160	318,100	5.73

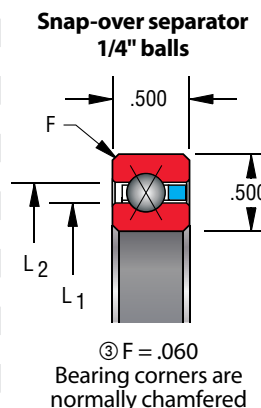

① Capacities listed are not simultaneous. For combined loading see discussion of [Bearing Selection](#) and [Load Analysis](#). Dynamic capacities are based upon 1 million revolutions of L10 life. Published capacities do not apply to hybrid series bearings P, X, and Y - contact Kaydon product engineering for values.

② Static capacities are non-brinell limits based on rigid support from the shaft and housing.

③ "F" is the maximum shaft or housing fillet radius the bearing corners will clear.

Type X – Open Reali-Slim Bearings, FOUR-POINT CONTACT

Selection Tables

Section 2

KF Series											
KAYDON Bearing Number	Dimensions in Inches				Capacities ^①						Approx. Wt. in lbs.
	Size		Land Diameters		Dynamic			Static ^②			
	Bore	Outside Dia.	L ₁	L ₂	Radial (lbs)	Thrust (lbs)	Moment (in-lbs)	Radial (lbs)	Thrust (lbs)	Moment (in-lbs)	
KF040XP0	4.000	5.500	4.555	4.945	4,665	6,830	8,312	5,360	13,400	12,730	1.9
KF042XP0	4.250	5.750	4.805	5.195	4,795	7,070	8,993	5,640	14,110	14,110	2.0
KF045XP0	4.500	6.000	5.055	5.445	4,923	7,300	9,695	5,930	14,810	15,550	2.1
KF047XP0	4.750	6.250	5.305	5.695	5,048	7,530	10,416	6,210	15,520	17,070	2.2
KF050XP0	5.000	6.500	5.555	5.945	5,172	7,760	11,157	6,490	16,220	18,660	2.3
KF055XP0	5.500	7.000	6.055	6.445	5,415	8,200	12,696	7,050	17,630	22,040	2.5
KF060XP0	6.000	7.500	6.555	6.945	5,651	8,630	14,311	7,620	19,050	25,710	2.7
KF065XP0	6.500	8.000	7.055	7.445	5,880	9,050	15,993	8,180	20,460	29,660	2.9
KF070XP0	7.000	8.500	7.555	7.945	6,103	9,460	17,744	8,750	21,870	33,890	3.2
KF075XP0	7.500	9.000	8.055	8.445	6,323	9,870	19,568	9,310	23,280	38,410	3.4
KF080XP0	8.000	9.500	8.555	8.945	6,535	10,260	21,453	9,880	24,690	43,200	3.5
KF090XP0	9.000	10.500	9.555	9.945	6,947	11,030	25,410	11,000	27,510	53,640	3.9
KF100XP0	10.000	11.500	10.555	10.945	7,342	11,770	29,608	12,130	30,330	65,210	4.3
KF110XP0	11.000	12.500	11.555	11.945	7,721	12,490	34,032	13,260	33,150	77,910	4.8
KF120XP0	12.000	13.500	12.555	12.945	8,084	13,190	38,666	14,390	35,970	91,730	5.2
KF140XP0	14.000	15.500	14.555	14.945	8,775	14,530	48,556	16,650	41,620	122,800	6.0
KF160XP0	16.000	17.500	16.555	16.945	9,421	15,820	59,200	18,900	47,260	158,300	7.1
KF180XP0	18.000	19.500	18.555	18.945	10,028	17,060	70,537	21,160	52,900	198,400	7.9
KF200XP0	20.000	21.500	20.555	20.945	10,602	18,250	82,528	23,420	58,550	243,000	8.9
KF250XP0	25.000	26.500	25.555	25.945	11,909	21,070	115,037	29,060	72,650	374,200	10.9
KF300XP0	30.000	31.500	30.555	30.945	13,065	23,720	150,708	34,700	86,760	533,600	13.0
KF350XP0	35.000	36.500	35.555	35.945	14,100	26,220	189,106	40,350	100,900	721,200	15.1
KF400XP0	40.000	41.500	40.555	40.945	15,034	28,620	229,832	45,990	115,000	937,100	17.2

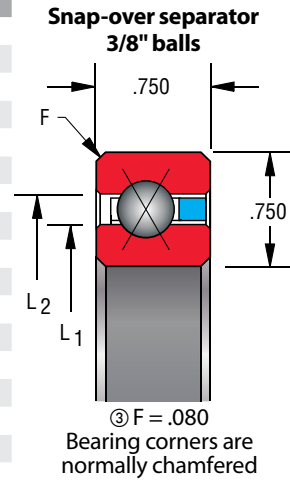

KG Series											
KAYDON Bearing Number	Dimensions in Inches				Capacities ^①						Approx. Wt. in lbs.
	Size		Land Diameters		Dynamic			Static ^②			
	Bore	Outside Dia.	L ₁	L ₂	Radial (lbs)	Thrust (lbs)	Moment (in-lbs)	Radial (lbs)	Thrust (lbs)	Moment (in-lbs)	
KG040XP0	4.000	6.000	4.742	5.258	7,979	11,260	14,966	8,210	20,520	20,520	3.6
KG042XP0	4.250	6.250	4.992	5.508	7,917	11,260	15,592	8,210	20,520	21,550	3.8
KG045XP0	4.500	6.500	5.242	5.758	8,205	11,750	16,930	8,760	21,890	24,080	4.0
KG047XP0	4.750	6.750	5.492	6.008	8,487	12,230	18,306	9,300	23,260	26,740	4.1
KG050XP0	5.000	7.000	5.742	6.258	8,762	12,710	19,721	9,850	24,620	29,550	4.3
KG055XP0	5.500	7.500	6.242	6.758	9,979	13,180	21,896	10,400	25,990	33,790	4.7
KG060XP0	6.000	8.000	6.742	7.258	9,503	14,090	24,956	11,490	28,730	40,220	5.1
KG065XP0	6.500	8.500	7.242	7.758	9,713	14,530	27,327	12,040	30,100	45,140	5.4
KG070XP0	7.000	9.000	7.742	8.258	10,208	15,400	30,636	13,130	32,830	52,530	5.8
KG075XP0	7.500	9.500	8.242	8.758	10,410	15,820	33,196	13,680	34,200	58,140	6.1
KG080XP0	8.000	10.000	8.742	9.258	10,882	16,650	36,743	14,770	36,940	66,480	6.5
KG090XP0	9.000	11.000	9.742	10.258	11,526	17,870	43,240	16,420	41,040	82,080	7.2
KG100XP0	10.000	12.000	10.742	11.258	12,147	19,040	50,124	18,060	45,140	99,320	7.9
KG110XP0	11.000	13.000	11.742	12.258	12,739	20,180	57,347	19,700	49,250	118,200	8.6
KG120XP0	12.000	14.000	12.742	13.258	13,315	21,280	64,935	21,340	53,350	138,700	9.3
KG140XP0	14.000	16.000	14.742	15.258	14,404	23,410	81,056	24,620	61,560	184,700	10.8
KG160XP0	16.000	18.000	16.742	17.258	15,425	25,450	98,373	27,910	69,770	237,200	12.3
KG180XP0	18.000	20.000	18.742	19.258	16,386	27,410	116,793	31,190	77,980	296,300	13.7
KG200XP0	20.000	22.000	20.742	21.258	17,293	29,300	136,238	34,470	86,180	362,000	15.8
KG220XP0	22.000	24.000	22.742	23.258	18,152	31,130	156,625	37,760	94,390	434,200	17.3
KG250XP0	25.000	27.000	25.742	26.258	19,360	33,780	188,838	42,680	106,700	554,900	19.5
KG300XP0	30.000	32.000	30.742	31.258	21,200	37,980	246,541	50,890	127,200	788,800	23.3
KG350XP0	35.000	37.000	35.742	36.258	22,845	41,970	308,527	59,100	147,700	1,064,000	27.1
KG400XP0	40.000	42.000	40.742	41.258	24,332	45,770	374,256	67,310	168,300	1,380,000	30.8

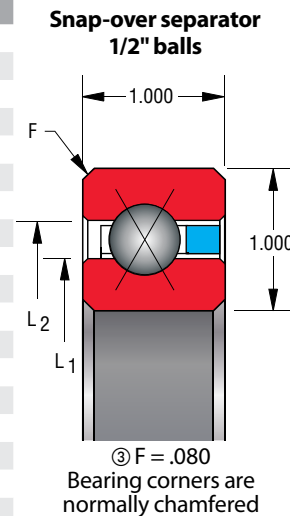

① Capacities listed are not simultaneous. For combined loading see discussion of [Bearing Selection and Load Analysis](#). Dynamic capacities are based upon 1 million revolutions of L10 life. Published capacities do not apply to hybrid series bearings P, X, and Y - contact Kaydon product engineering for values.

② Static capacities are non-brinell limits based on rigid support from the shaft and housing.

③ "F" is the maximum shaft or housing fillet radius the bearing corners will clear.

Sealed Reali-Slim Bearing Selections

Seals and Shields Available

To realize the full benefits from anti-friction bearings, it is important to keep them clean and well lubricated. Seals and shields, properly designed and mounted, help to accomplish this. In this catalog these terms have the following definitions:

Seal – a contacting closure between the stationary and rotating members, for retaining lubricant within and excluding foreign material from the bearing. Seals are retained in the outer race and make positive contact with the inner race.

Shield – a closure for the same purpose as a seal but without positive contact.

A seal is more effective, but requires more turning effort (torque), generates more heat, and as a result, has a lower speed limit than an open or shielded bearing.

The accompanying illustrations are examples by which Reali-Slim bearings may be sealed or shielded, either integrally or externally. The lubricant and lubrication systems, torque requirements, speed, and operating environment will influence the choice.

Integral seals and shields offer a very compact overall design with the additional advantage of protecting the bearing before, during and after installation.

Figure 2-2 shows a double-sealed Reali-Slim bearing, available from stock in the JU series. In this case, adding shields and seals requires an increase in the width of the bearing (see [page 2](#), Position 2). In the case of JA, JB, and JG double-sealed Reali-Slim bearings, the bearing width is the same as that of the open bearing.

Shown in Figure 2-4 is a double-shielded bearing for use where a shield will suffice or is required due to torque limitations or speed.

Where weight and space are at a premium, and a seal or shield is required on one side only, single-sealed or single-shielded bearings are available as custom options.

Note: Sealed Reali-Slim bearings are pre-lubricated with a general purpose grease. Operating conditions (i.e. time, temperature, speed, environment) may result in premature lubrication degradation. A variety of lubricants are available as options to meet your specifications.

Figure 2-1
Double-Sealed Reali-Slim JA/JB bearing

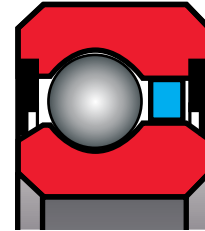

Figure 2-2
Double-Sealed Reali-Slim JU bearing

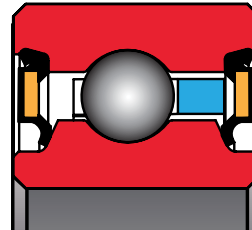

Figure 2-3
Double-Sealed Reali-Slim JG bearing

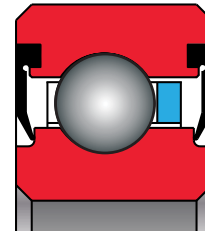
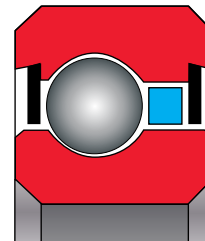

Figure 2-4
Double-Shielded Reali-Slim EA/EB bearing



Note: Pictures are for illustration only and are not intended for design specification.

Sealed Reali-Slim Bearings, Seals and Shields (continued)

Figure 2-5 shows a nitrile lip-type seal ring available in a variety of cross-sections compatible with the Reali-Slim bearing series. While this is a very effective seal, torque is substantial and speeds must not exceed 1000 feet per minute if continuous.

If grease lubrication is used and torque is not critical, a very effective shield is that shown in Figure 2-6, where annular grooves are cut in the housing shoulder and clamp plate and filled with grease.

Figure 2-5
Nitrile Lip-Type Seal

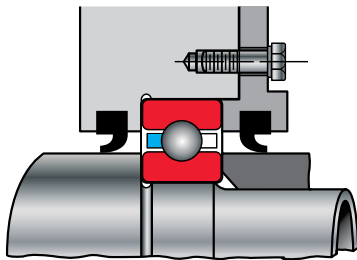

Figure 2-6
Annular Grooves

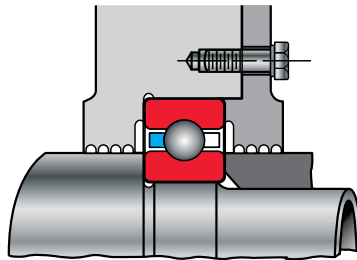
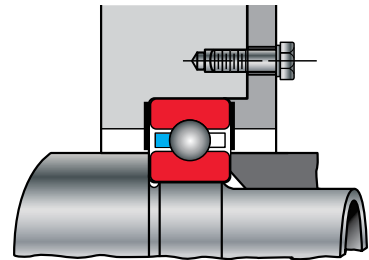

Figure 2-7
Washer Shield From Precision Flat Stock



When a separate shield is required, washers made from precision flat stock are ideal, as shown in Figure 2-7. They serve well where weight limitations are strict.

Whether or not integral seals or shields are specified, bearings must be isolated from hostile environments and debris.

All the sealed bearings on the following pages are also available in stainless steel. To order, replace the J in the part number with a W.

Sealed Reali-Slim Bearing Selections

Type C – RADIAL CONTACT

A Conrad assembled bearing designed primarily for application of radial load—deep ball grooves also permit application of

thrust load in either direction – often used in conjunction with another bearing.

JHA Series (Double Sealed)										
KAYDON Bearing Number	Dimensions in Inches				Capacities in Pounds ^①			Limiting Speeds (RPM*)	Torque Max. No Load (in-oz) ^④	Approx. Wt. in lbs.
	Size		Land Diameters		Dynamic		Static ^② Radial			
	Bore	Outside Dia.	L ₁	L ₂	KAYDON Radial	ISO Radial ^③				
JHA10CLO	1.000	1.375	1.108	1.274	188	558	290	6,110	5	.035
JHA15CLO	1.500	1.875	1.608	1.774	225	632	400	4,300	5	.052
JHA17CLO	1.750	2.125	1.858	2.024	242	663	460	3,750	6	.060

Snap-over separator 3/32" balls

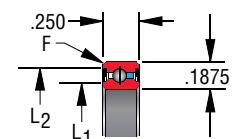

⑤ F = .015
Bearing corners are normally chamfered

JA Series (Double Sealed)										
KAYDON Bearing Number	Dimensions in Inches				Capacities in Pounds ^①			Limiting Speeds (RPM*)	Torque Max. No Load (in-oz) ^④	Approx. Wt. in lbs.
	Size		Land Diameters		Dynamic		Static ^② Radial			
	Bore	Outside Dia.	L ₁	L ₂	KAYDON Radial	ISO Radial ^③				
JA020CP0	2.000	2.500	2.148	2.356	393	1,012	680	3,220	6	.10
JA025CP0	2.500	3.000	2.648	2.856	442	1,094	830	2,630	8	.12
JA030CP0	3.000	3.500	3.148	3.356	487	1,166	990	2,230	12	.14
JA035CP0	3.500	4.000	3.648	3.856	530	1,230	1,140	1,930	16	.17
JA040CP0	4.000	4.500	4.148	4.356	571	1,289	1,290	1,700	20	.19
JA042CP0	4.250	4.750	4.398	4.606	591	1,317	1,370	1,610	24	.20
JA045CP0	4.500	5.000	4.648	4.856	610	1,344	1,440	1,520	28	.21
JA047CP0	4.750	5.250	4.898	5.106	629	1,369	1,520	1,450	32	.22
JA050CP0	5.000	5.500	5.148	5.356	648	1,394	1,590	1,380	36	.23
JA055CP0	5.500	6.000	5.648	5.856	685	1,442	1,750	1,260	44	.25
JA060CP0	6.000	6.500	6.148	6.356	720	1,487	1,900	1,160	52	.28
JA065CP0	6.500	7.000	6.648	6.856	754	1,530	2,050	1,070	61	.30
JA070CP0	7.000	7.500	7.148	7.356	787	1,571	2,200	1,000	70	.31
JA075CP0	7.500	8.000	7.648	7.856	820	1,610	2,350	930	80	.34

Snap-over separator 1/8" balls

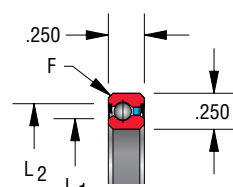

⑤ F = .025
Bearing corners are normally chamfered

① Capacities listed are not simultaneous. For combined loading see discussion of [Bearing Selection](#) and [Load Analysis](#). Dynamic capacities are based upon 1 million revolutions of L10 life. Published capacities do not apply to hybrid series bearings P, X, and Y - contact Kaydon product engineering for values.

② Static capacities are non-brinell limits based on rigid support from the shaft and housing.

③ ISO Radial ratings are calculated per ISO 281:1990. They are included for comparison only (refer to [Page 95](#)).

④ Torque figures shown are for single bearings with standard internal fit-up, standard lubricant at room temperature, and under 5 pounds thrust load.

⑤ "F" is the maximum shaft or housing fillet radius the bearing corners will clear.

*Values apply to bearings loaded up to 20% of their dynamic capacity.

Type C – Sealed Reali-Slim Bearings, RADIAL CONTACT

JB Series (Double Sealed)										
KAYDON Bearing Number	Dimensions in Inches				Capacities in Pounds ^①			Limiting Speeds (RPM*)	Torque Max. No Load (in-oz) ^④	Approx. Wt. in lbs.
	Size		Land Diameters		Dynamic		Static ^② Radial			
	Bore	Outside Dia.	L ₁	L ₂	KAYDON Radial	ISO Radial ^③				
JB020CP0	2.000	2.625	2.199	2.425	577	1,431	930	3,130	6	.15
JB025CP0	2.500	3.125	2.699	2.925	644	1,549	1,140	2,580	8	.19
JB030CP0	3.000	3.625	3.199	3.425	707	1,651	1,340	2,190	12	.22
JB035CP0	3.500	4.125	3.699	3.925	767	1,743	1,540	1,900	16	.27
JB040CP0	4.000	4.625	4.199	4.425	825	1,827	1,750	1,630	20	.30
JB042CP0	4.250	4.875	4.449	4.675	846	1,853	1,830	1,600	24	.31
JB045CP0	4.500	5.125	4.699	4.925	880	1,904	1,950	1,500	28	.34
JB047CP0	4.750	5.375	4.949	5.175	901	1,928	2,030	1,430	32	.35
JB050CP0	5.000	5.625	5.199	5.425	933	1,976	2,150	1,360	36	.37
JB055CP0	5.500	6.125	5.699	5.925	984	2,044	2,360	1,240	44	.40
JB060CP0	6.000	6.625	6.199	6.425	1,034	2,108	2,560	1,150	52	.44
JB065CP0	6.500	7.125	6.699	6.925	1,082	2,168	2,760	1,060	61	.47

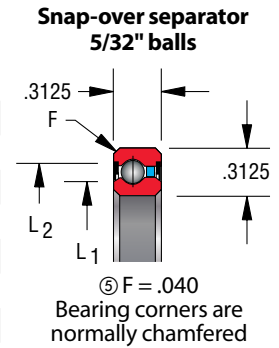

JU Series (Double Sealed)										
KAYDON Bearing Number	Dimensions in Inches				Capacities in Pounds ^①			Limiting Speeds (RPM*)	Torque Max. No Load (in-lb) ^④	Approx. Wt. in lbs.
	Size		Land Diameters		Dynamic		Static ^② Radial			
	Bore	Outside Dia.	L ₁	L ₂	KAYDON Radial	ISO Radial ^③				
JU040CP0	4.000	4.750	4.150	4.543	1,073	2,321	2,100	1,640	2.9	.55
JU042CP0	4.250	5.000	4.400	4.793	1,108	2,370	2,220	1,520	3.2	.58
JU045CP0	4.500	5.250	4.650	5.043	1,143	2,418	2,340	1,440	3.5	.61
JU047CP0	4.750	5.500	4.900	5.293	1,176	2,464	2,460	1,360	3.9	.65
JU050CP0	5.000	5.750	5.150	5.543	1,209	2,509	2,590	1,300	4.3	.68
JU055CP0	5.500	6.250	5.650	6.043	1,274	2,594	2,830	1,180	5.1	.74
JU060CP0	6.000	6.750	6.150	6.543	1,337	2,674	3,070	1,080	6.1	.81
JU065CP0	6.500	7.250	6.650	7.043	1,397	2,751	3,315	1,000	7.0	.87
JU070CP0	7.000	7.750	7.150	7.543	1,457	2,823	3,550	920	8.1	.93
JU075CP0	7.500	8.250	7.650	8.043	1,514	2,893	3,790	860	9.2	.99
JU080CP0	8.000	8.750	8.150	8.543	1,570	2,960	4,030	810	10.4	1.06
JU085CP0	8.500	9.250	8.650	9.037	1,624	3,024	4,270	770	11.7	1.12
JU090CP0	9.000	9.750	9.150	9.543	1,678	3,085	4,510	720	13.0	1.18
JU100CP0	10.000	10.750	10.150	10.543	1,781	3,203	4,990	650	16.0	1.31
JU110CP0	11.000	11.750	11.150	11.543	1,879	3,313	5,470	590	19.2	1.43
JU120CP0	12.000	12.750	12.150	12.543	1,974	3,417	5,950	540	22.8	1.56

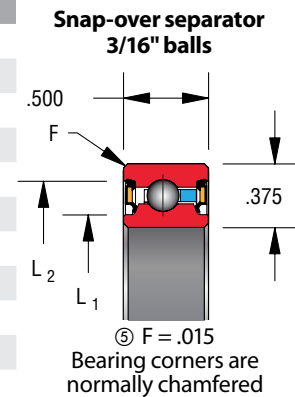

① Capacities listed are not simultaneous. For combined loading see discussion of [Bearing Selection](#) and [Load Analysis](#). Dynamic capacities are based upon 1 million revolutions of L10 life. Published capacities do not apply to hybrid series bearings P, X, and Y - contact Kaydon product engineering for values.

② Static capacities are non-brinell limits based on rigid support from the shaft and housing.

③ ISO Radial ratings are calculated per ISO 281:1990. They are included for comparison only (refer to [Page 95](#)).

④ Torque figures shown are for single bearings with standard internal fit-up, standard lubricant at room temperature, and under 5 pounds thrust load.

⑤ "F" is the maximum shaft or housing fillet radius the bearing corners will clear.

*Values apply to bearings loaded up to 20% of their dynamic capacity.

Type C – Sealed Reali-Slim Bearings, RADIAL CONTACT

JG Series (Double Sealed)										
KAYDON Bearing Number	Dimensions in Inches				Capacities in Pounds ^①			Limiting Speeds (RPM ^⑤)	Torque Max. No Load (in-lb) ^④	Approx. Wt. in lbs.
	Size		Land Diameters		Dynamic		Static ^② Radial			
	Bore	Outside Dia.	L ₁	L ₂	KAYDON Radial	ISO Radial ^③				
JG070CP0	7.000	9.000	7.554	8.602	7,764	11,705	13,130	240	17	5.8
JG075CP0	7.500	9.500	8.054	9.102	7,911	11,835	13,680	225	19	6.1
JG080CP0	8.000	10.000	8.554	9.602	8,265	12,266	14,770	210	21	6.5
JG090CP0	9.000	11.000	9.554	10.602	8,743	12,782	16,420	190	26	7.2
JG100CP0	10.000	12.000	10.554	11.602	9,204	13,261	18,060	175	32	7.9
JG110CP0	11.000	13.000	11.554	12.602	9,648	13,710	19,700	160	38	8.6
JG120CP0	12.000	14.000	12.554	13.602	10,074	14,133	21,340	140	44	9.3
JG140CP0	14.000	16.000	14.554	15.602	10,886	14,916	24,620	125	59	10.8
JG160CP0	16.000	18.000	16.554	17.602	11,648	15,631	27,910	110	76	12.3
JG180CP0	18.000	20.000	18.554	19.602	12,367	16,291	31,190	100	95	13.7
JG200CP0	20.000	22.000	20.554	21.602	13,044	16,907	34,470	90	115	15.8
JG220CP0	22.000	24.000	22.554	23.602	13,685	17,486	37,760	80	139	16.8
JG250CP0	25.000	27.000	25.554	26.602	14,591	18,295	42,680	75	177	19.5
JG300CP0	30.000	32.000	30.554	31.602	15,963	19,519	50,890	60	252	23.3
JG350CP0	35.000	37.000	35.554	36.602	17,195	20,622	59,100	55	339	27.1
JG400CP0	40.000	42.000	40.554	41.602	18,307	21,630	67,310	50	440	30.8

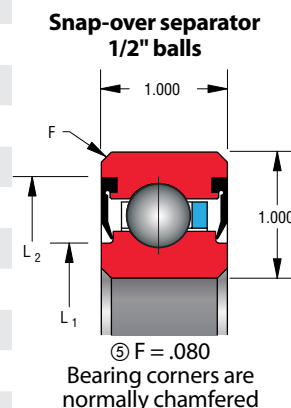

① Capacities listed are not simultaneous. For combined loading see discussion of Bearing Selection and Load Analysis. Dynamic capacities are based upon 1 million revolutions of L10 life. Published capacities do not apply to hybrid series bearings P, X, and Y - contact Kaydon product engineering for values.
 ② Static capacities are non-brinell limits based on rigid support from the shaft and housing.
 ③ ISO Radial ratings are calculated per ISO 281:1990. They are included for comparison only (refer to Page 95).
 ④ Torque figures shown are for single bearings with standard internal fit-up, standard lubricant at room temperature, and under 5 pounds thrust load.
 ⑤ "F" is the maximum shaft or housing fillet radius the bearing corners will clear.
 *Values apply to bearings loaded up to 20% of their dynamic capacity.

CONTACT Kaydon at —
Kaydon Bearings • Muskegon, Michigan 49443
Telephone: 231-755-3741 • Fax: 231-759-4102

Need Service Fast?
1-800-514-3066
www.kaydonbearings.com



Sealed Reali-Slim Bearing Selections

Type X – FOUR-POINT CONTACT

A Conrad assembled bearing designed for applications involving multiple loads. Unique internal geometry permits application of radial load, thrust load in either direction, and moment load,

individually or in any combination. A single four-point contact bearing may replace two bearings in many applications.

JHA Series (Double Sealed)													
KAYDON Bearing Number	Dimensions in Inches				Capacities ^①						Limiting Speeds (RPM*)	Torque Max. No Load (in-oz) ^③	Approx. Wt. in lbs.
	Size		Land Diameters		Dynamic			Static ^②					
	Bore	Outside Dia.	L ₁	L ₂	Radial (lbs)	Thrust (lbs)	Moment (in-lbs)	Radial (lbs)	Thrust (lbs)	Moment (in-lbs)			
JHA10XLO	1.000	1.375	1.108	1.274	247	370	110	290	730	170	3,000	5	.035
JHA15XLO	1.500	1.875	1.608	1.774	296	460	187	400	1,000	340	2,000	5	.052
JHA17XLO	1.750	2.125	1.858	2.024	319	500	232	460	1,140	440	1,710	6	.060

Snap-over separator 3/32" balls

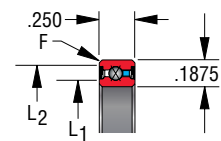

④ F = .015
Bearing corners are normally chamfered

JA Series (Double Sealed)													
KAYDON Bearing Number	Dimensions in Inches				Capacities ^①						Limiting Speeds (RPM*)	Torque Max. No Load (in-oz) ^③	Approx. Wt. in lbs.
	Size		Land Diameters		Dynamic			Static ^②					
	Bore	Outside Dia.	L ₁	L ₂	Radial (lbs)	Thrust (lbs)	Moment (in-lbs)	Radial (lbs)	Thrust (lbs)	Moment (in-lbs)			
JA020XP0	2.000	2.500	2.148	2.356	514	790	434	680	1,710	770	1,500	6	.10
JA025XP0	2.500	3.000	2.648	2.856	583	910	601	830	2,090	1,150	1,200	8	.12
JA030XP0	3.000	3.500	3.148	3.356	643	1,010	785	990	2,470	1,600	830	12	.14
JA035XP0	3.500	4.000	3.648	3.856	701	1,110	986	1,140	2,850	2,130	710	16	.17
JA040XP0	4.000	4.500	4.148	4.356	756	1,210	1,205	1,290	3,220	2,740	620	20	.19
JA042XP0	4.250	4.750	4.398	4.606	783	1,260	1,321	1,370	3,410	3,070	580	24	.20
JA045XP0	4.500	5.000	4.648	4.856	809	1,310	1,441	1,440	3,600	3,420	550	28	.21
JA047XP0	4.750	5.250	4.898	5.106	834	1,350	1,565	1,520	3,790	3,790	520	32	.22
JA050XP0	5.000	5.500	5.148	5.356	859	1,400	1,693	1,590	3,980	4,180	500	36	.23
JA055XP0	5.500	6.000	5.648	5.856	908	1,480	1,959	1,750	4,360	5,020	450	44	.25
JA060XP0	6.000	6.500	6.148	6.356	955	1,570	2,240	1,900	4,740	5,930	330	52	.28
JA065XP0	6.500	7.000	6.648	6.856	1,001	1,650	2,535	2,050	5,120	6,910	300	61	.30
JA070XP0	7.000	7.500	7.148	7.356	1,046	1,730	2,844	2,200	5,500	7,980	280	70	.31
JA075XP0	7.500	8.000	7.648	7.856	1,089	1,810	3,165	2,350	5,880	9,120	260	80	.34

Snap-over separator 1/8" balls

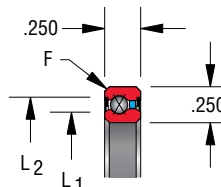

④ F = .025
Bearing corners are normally chamfered

① Capacities listed are not simultaneous. For combined loading see discussion of Bearing Selection and Load Analysis. Dynamic capacities are based upon 1 million revolutions of L10 life. Published capacities do not apply to hybrid series bearings P, X, and Y - contact Kaydon product engineering for values.
 ② Static capacities are non-brinell limits based on rigid support from the shaft and housing.
 ③ Torque figures shown are for single bearings with standard internal fit-up, standard lubricant at room temperature, and under 5 pounds thrust load.
 ④ "F" is the maximum shaft or housing fillet radius the bearing corners will clear.
 *Values apply to bearings loaded up to 20% of their dynamic capacity.

Type X – Sealed Real-Slim Bearings, FOUR-POINT CONTACT

JB Series (Double Sealed)													
KAYDON Bearing Number	Dimensions in Inches				Capacities ^①						Limiting Speeds (RPM*)	Torque Max. No Load (in-oz) ^③	Approx. Wt. in lbs.
	Size		Land Diameters		Dynamic			Static ^②					
	Bore	Outside Dia.	L ₁	L ₂	Radial (lbs)	Thrust (lbs)	Moment (in-lbs)	Radial (lbs)	Thrust (lbs)	Moment (in-lbs)			
JB020XPO	2.000	2.625	2.199	2.425	758	1,130	658	930	2,340	1,080	1,500	6	.15
JB025XPO	2.500	3.125	2.699	2.925	848	1,290	895	1,140	2,840	1,600	1,200	8	.19
JB030XPO	3.000	3.625	3.199	3.425	933	1,440	1,159	1,340	3,350	2,220	1,000	12	.22
JB035XPO	3.500	4.125	3.699	3.925	1,014	1,590	1,450	1,540	3,860	2,940	710	16	.27
JB040XPO	4.000	4.625	4.199	4.425	1,091	1,720	1,764	1,750	4,370	3,770	620	20	.30
JB042XPO	4.250	4.875	4.449	4.675	1,120	1,780	1,917	1,830	4,570	4,170	590	24	.31
JB045XPO	4.500	5.125	4.699	4.925	1,165	1,850	2,103	1,950	4,880	4,690	550	28	.34
JB047XPO	4.750	5.375	4.949	5.175	1,193	1,900	2,265	2,030	5,080	5,140	520	32	.35
JB050XPO	5.000	5.625	5.199	5.425	1,236	1,980	2,463	2,150	5,380	5,720	500	36	.37
JB055XPO	5.500	6.125	5.699	5.925	1,304	2,100	2,844	2,360	5,890	6,850	450	44	.40
JB060XPO	6.000	6.625	6.199	6.425	1,371	2,220	3,247	2,560	6,400	8,080	410	52	.44
JB065XPO	6.500	7.125	6.699	6.925	1,435	2,340	3,668	2,760	6,910	9,410	380	61	.47

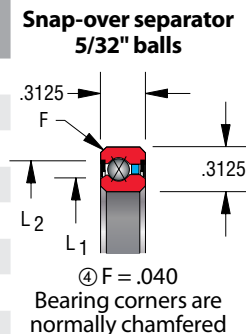

JU Series (Double Sealed)													
KAYDON Bearing Number	Dimensions in Inches				Capacities ^①						Limiting Speeds (RPM*)	Torque Max. No Load (in-lb) ^③	Approx. Wt. in lbs.
	Size		Land Diameters		Dynamic			Static ^②					
	Bore	Outside Dia.	L ₁	L ₂	Radial (lbs)	Thrust (lbs)	Moment (in-lbs)	Radial (lbs)	Thrust (lbs)	Moment (in-lbs)			
JU040XPO	4.000	4.750	4.150	4.543	1,417	2,210	2,326	2,100	5,260	4,600	620	2.9	.55
JU042XPO	4.250	5.000	4.400	4.793	1,464	2,290	2,541	2,220	5,560	5,140	590	3.2	.58
JU045XPO	4.500	5.250	4.650	5.043	1,510	2,380	2,762	2,340	5,860	5,710	550	3.5	.61
JU047XPO	4.750	5.500	4.900	5.293	1,556	2,460	2,991	2,460	6,160	6,320	520	3.9	.65
JU050XPO	5.000	5.750	5.150	5.543	1,600	2,540	3,226	2,590	6,460	6,950	500	4.3	.68
JU055XPO	5.500	6.250	5.650	6.043	1,687	2,690	3,717	2,830	7,060	8,300	450	5.1	.74
JU060XPO	6.000	6.750	6.150	6.543	1,770	2,840	4,234	3,070	7,660	9,770	410	6.1	.81
JU065XPO	6.500	7.250	6.650	7.043	1,851	2,990	4,775	3,310	8,270	11,370	380	7.0	.87
JU070XPO	7.000	7.750	7.150	7.543	1,931	3,130	5,341	3,550	8,870	13,080	350	8.1	.93
JU075XPO	7.500	8.250	7.650	8.043	2,007	3,270	5,930	3,790	9,470	14,910	330	9.2	.99
JU080XPO	8.000	8.750	8.150	8.543	2,082	3,410	6,542	4,030	10,070	16,870	310	10.4	1.06
JU085XPO	8.500	9.250	8.650	9.043	2,155	3,543	7,176	4,270	10,670	18,940	265	11.7	1.12
JU090XPO	9.000	9.750	9.150	9.543	2,226	3,670	7,830	4,510	11,270	21,130	220	13.0	1.18
JU100XPO	10.000	10.750	10.150	10.543	2,364	3,930	9,201	4,990	12,470	25,880	200	16.0	1.31
JU110XPO	11.000	11.750	11.150	11.543	2,496	4,180	10,651	5,470	13,680	31,110	180	19.2	1.43
JU120XPO	12.000	12.750	12.150	12.543	2,622	4,420	12,174	5,950	14,880	36,830	160	22.8	1.56

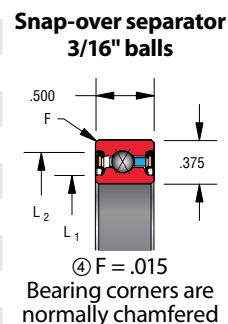

① Capacities listed are not simultaneous. For combined loading see discussion of Bearing Selection and Load Analysis. Dynamic capacities are based upon 1 million revolutions of L10 life. Published capacities do not apply to hybrid series bearings P, X, and Y - contact Kaydon product engineering for values.
 ② Static capacities are non-brinell limits based on rigid support from the shaft and housing.
 ③ Torque figures shown are for single bearings with standard internal fit-up, standard lubricant at room temperature, and under 5 pounds thrust load.
 ④ "F" is the maximum shaft or housing fillet radius the bearing corners will clear.
 *Values apply to bearings loaded up to 20% of their dynamic capacity.

Type X – Sealed Real-Slim Bearings, FOUR-POINT CONTACT

JG Series													
KAYDON Bearing Number	Dimensions in Inches				Capacities ^①						Limiting Speeds (RPM ^④)	Torque Max. No Load (in-lb) ^③	Approx. Wt. in lbs.
	Size		Land Diameters		Dynamic			Static ^②					
	Bore	Outside Dia.	L ₁	L ₂	Radial (lbs)	Thrust (lbs)	Moment (in-lbs)	Radial (lbs)	Thrust (lbs)	Moment (in-lbs)			
JG070XP0	7.000	9.000	7.554	8.602	10,208	15,400	30,636	13,130	32,830	52,530	240	17	5.8
JG075XP0	7.500	9.500	8.054	9.102	10,410	15,820	33,196	13,680	34,200	58,140	225	19	6.1
JG080XP0	8.000	10.000	8.554	9.602	10,882	16,650	36,743	14,770	36,940	66,480	210	21	6.5
JG090XP0	9.000	11.000	9.554	10.602	11,526	17,870	43,240	16,420	41,040	82,080	190	26	7.2
JG100XP0	10.000	12.000	10.554	11.602	12,147	19,040	50,124	18,060	45,140	99,320	175	32	7.9
JG110XP0	11.000	13.000	11.554	12.602	12,739	20,180	57,347	19,700	49,250	118,200	160	38	8.6
JG120XP0	12.000	14.000	12.554	13.602	13,315	21,280	64,935	21,340	53,350	138,700	140	44	9.3
JG140XP0	14.000	16.000	14.554	15.602	14,404	34,410	81,056	24,620	61,560	184,700	125	59	10.8
JG160XP0	16.000	18.000	16.554	17.602	15,425	25,450	98,373	27,910	69,770	237,200	110	76	12.3
JG180XP0	18.000	20.000	18.554	19.602	16,386	27,410	116,793	31,190	77,980	296,300	100	95	13.7
JG200XP0	20.000	22.000	20.554	21.602	17,293	29,300	136,238	34,470	86,180	362,000	90	115	15.8
JG220XP0	22.000	24.000	22.554	23.602	18,152	31,130	156,625	37,750	94,390	434,200	80	138	16.8
JG250XP0	25.000	27.000	25.554	26.602	19,360	33,780	188,838	42,680	106,700	554,900	75	177	19.5
JG300XP0	30.000	32.000	30.554	31.602	21,200	37,980	246,541	50,890	127,200	788,800	60	252	23.3
JG350XP0	35.000	37.000	35.554	36.602	22,845	41,970	308,527	59,100	147,700	1,064,000	55	339	27.1
JG400XP0	40.000	42.000	40.554	41.602	24,332	45,770	374,256	63,310	168,300	1,380,000	50	440	30.8

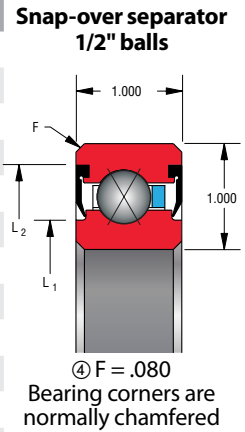

① Capacities listed are not simultaneous. For combined loading see discussion of Bearing Selection and Load Analysis. Dynamic capacities are based upon 1 million revolutions of L10 life. Published capacities do not apply to hybrid series bearings P, X, and Y - contact Kaydon product engineering for values.

② Static capacities are non-brinell limits based on rigid support from the shaft and housing.

③ Torque figures shown are for single bearings with standard internal fit-up, standard lubricant at room temperature, and under 5 pounds thrust load.

④ "F" is the maximum shaft or housing fillet radius the bearing corners will clear.

*Values apply to bearings loaded up to 20% of their dynamic capacity.

CONTACT Kaydon at —
Kaydon Bearings • Muskegon, Michigan 49443
Telephone: 231-755-3741 • Fax: 231-759-4102



Need Service Fast?
1-800-514-3066
www.kaydonbearings.com



Precision Tolerances and Recommended Fits for Reali-Slim Ball Bearings in Normal Applications

Type C – Precision Class 1 (Ref. ABEC 1F)												
Bearing Size (Inch Series)	Bearing Diameters		Radial & Axial Runout		Rotating Shaft or Duplex DF Mounting		Stationary Shaft or Duplex DB Mounting			Bearing Diametral Clearance* Before Installation		
	Bearing Bore Nominal +.0000	Bearing O.D. Nominal +.0000	Inner Race	Outer Race	Shaft Diameter Nominal –.0000	Housing Bore Nominal –.0000	Shaft Diameter Nominal	Housing Bore Nominal				
010	-.0004	-.0005	.0005	.0008	+0.0004	+0.0005	-.0004	-.0008	-.0005	-.0010	.0010	.0016
015	-.0005	-.0005	.0006	.0008	+0.0005	+0.0005	-.0005	-.0010	-.0005	-.0010	.0012	.0018
017	-.0006	-.0005	.0008	.0010	+0.0006	+0.0005	-.0006	-.0012	-.0005	-.0010	.0012	.0024
020	-.0006	-.0005	.0008	.0010	+0.0006	+0.0005	-.0006	-.0012	-.0005	-.0010	.0012	.0024
025	-.0006	-.0005	.0008	.0010	+0.0006	+0.0005	-.0006	-.0012	-.0005	-.0010	.0012	.0024
030	-.0006	-.0006	.0008	.0010	+0.0006	+0.0006	-.0006	-.0012	-.0006	-.0012	.0012	.0024
035	-.0008	-.0006	.0010	.0012	+0.0008	+0.0006	-.0008	-.0016	-.0006	-.0012	.0016	.0028
040	-.0008	-.0006	.0010	.0012	+0.0008	+0.0006	-.0008	-.0016	-.0006	-.0012	.0016	.0028
042	-.0008	-.0008	.0010	.0014	+0.0008	+0.0008	-.0008	-.0016	-.0008	-.0016	.0016	.0028
045	-.0008	-.0008	.0010	.0014	+0.0008	+0.0008	-.0008	-.0016	-.0008	-.0016	.0016	.0028
047	-.0010	-.0008	.0012	.0014	+0.0010	+0.0008	-.0010	-.0020	-.0008	-.0016	.0020	.0034
050	-.0010	-.0008	.0012	.0014	+0.0010	+0.0008	-.0010	-.0020	-.0008	-.0016	.0020	.0034
055	-.0010	-.0010	.0012	.0016	+0.0010	+0.0010	-.0010	-.0020	-.0010	-.0020	.0020	.0034
060	-.0010	-.0010	.0012	.0016	+0.0010	+0.0010	-.0010	-.0020	-.0010	-.0020	.0020	.0034
065	-.0010	-.0010	.0012	.0016	+0.0010	+0.0010	-.0010	-.0020	-.0010	-.0020	.0020	.0034
070	-.0010	-.0012	.0012	.0016	+0.0010	+0.0012	-.0010	-.0020	-.0012	-.0024	.0024	.0042
075	-.0012	-.0012	.0016	.0018	+0.0012	+0.0012	-.0012	-.0024	-.0012	-.0024	.0024	.0042
080	-.0012	-.0012	.0016	.0018	+0.0012	+0.0012	-.0012	-.0024	-.0012	-.0024	.0024	.0042
090	-.0012	-.0012	.0016	.0018	+0.0012	+0.0012	-.0012	-.0024	-.0012	-.0024	.0024	.0042
100	-.0014	-.0014	.0018	.0020	+0.0014	+0.0014	-.0014	-.0028	-.0014	-.0028	.0028	.0048
110	-.0014	-.0014	.0018	.0020	+0.0014	+0.0014	-.0014	-.0028	-.0014	-.0028	.0028	.0048
120	-.0014	-.0014	.0018	.0020	+0.0014	+0.0014	-.0014	-.0028	-.0014	-.0028	.0028	.0048
140	-.0016	-.0016	.0018	.0020	+0.0016	+0.0016	-.0016	-.0032	-.0016	-.0032	.0032	.0052
160	-.0018	-.0018	.0018	.0020	+0.0018	+0.0018	-.0018	-.0036	-.0018	-.0036	.0036	.0056
180	-.0018	-.0018	.0020	.0020	+0.0018	+0.0018	-.0018	-.0036	-.0018	-.0036	.0036	.0056
200	-.0020	-.0020	.0020	.0020	+0.0020	+0.0020	-.0020	-.0040	-.0020	-.0040	.0040	.0060
210	-.0020	-.0020	.0020	.0020	+0.0020	+0.0020	-.0020	-.0040	-.0020	-.0040	.0040	.0060
220	-.0020	-.0020	.0020	.0020	+0.0020	+0.0020	-.0020	-.0040	-.0020	-.0040	.0040	.0060
250	-.0030	-.0030	.0020	.0020	+0.0030	+0.0030	-.0030	-.0060	-.0030	-.0060	.0060	.0080
300	-.0030	-.0030	.0020	.0020	+0.0030	+0.0030	-.0030	-.0060	-.0030	-.0060	.0060	.0080
350	-.0040	-.0040	.0020	.0020	+0.0040	+0.0040	-.0040	-.0080	-.0040	-.0080	.0080	.0100
400	-.0040	-.0040	.0020	.0020	+0.0040	+0.0040	-.0040	-.0080	-.0040	-.0080	.0080	.0100

* Diametral clearance after installation theoretically can range rather widely if all contributing bearing, housing, and shaft tolerances are at either of their extremes.

Race Width Tolerance:
 Up thru 12" Bearing Bore +.000 –.005
 Over 12" Bearing Bore +.000 –.010

Listed shaft and housing diameters are for steel supports with standard bearing diametral clearance. Recommended shaft and housing diameters can change greatly based on orientation, temperature, speed, non-standard diametral clearances, and desired performance characteristics. Contact Kaydon for design assistance when required.

All dimensions in inches.

Precision Tolerances and Recommended Fits for Reali-Slim Bearings (continued)

Type X and A – Precision Class 1 (Ref. ABEC 1F)												
Bearing Size (Inch Series)	Bearing Diameters		Radial & Axial Runout		Rotating Shaft or Duplex DF Mounting		Stationary Shaft or Duplex DB Mounting			Bearing Diametral Clearance* (Type "X" only) Before Installation		
	Bearing Bore Nominal +.0000	Bearing O.D. Nominal +.0000	Inner Race	Outer Race	Shaft Diameter Nominal -.0000	Housing Bore Nominal -.0000	Shaft Diameter Nominal	Housing Bore Nominal				
010	-.0004	-.0005	.0003	.0004	+.0004	+.0005	-.0004	-.0008	-.0005	-.0010	.0010	.0015
015	-.0005	-.0005	.0004	.0004	+.0005	+.0005	-.0005	-.0010	-.0005	-.0010	.0012	.0017
017	-.0006	-.0005	.0005	.0005	+.0006	+.0005	-.0006	-.0012	-.0005	-.0010	.0012	.0022
020	-.0006	-.0005	.0005	.0005	+.0006	+.0005	-.0006	-.0012	-.0005	-.0010	.0012	.0022
025	-.0006	-.0005	.0005	.0005	+.0006	+.0005	-.0006	-.0012	-.0005	-.0010	.0012	.0022
030	-.0006	-.0006	.0006	.0006	+.0006	+.0006	-.0006	-.0012	-.0006	-.0012	.0012	.0022
035	-.0008	-.0006	.0006	.0006	+.0008	+.0006	-.0008	-.0016	-.0006	-.0012	.0016	.0026
040	-.0008	-.0006	.0006	.0006	+.0008	+.0006	-.0008	-.0016	-.0006	-.0012	.0016	.0026
042	-.0008	-.0008	.0008	.0008	+.0008	+.0008	-.0008	-.0016	-.0008	-.0016	.0016	.0026
045	-.0008	-.0008	.0008	.0008	+.0008	+.0008	-.0008	-.0016	-.0008	-.0016	.0016	.0026
047	-.0010	-.0008	.0008	.0008	+.0010	+.0008	-.0010	-.0020	-.0008	-.0016	.0020	.0030
050	-.0010	-.0008	.0008	.0008	+.0010	+.0008	-.0010	-.0020	-.0008	-.0016	.0020	.0030
055	-.0010	-.0010	.0010	.0010	+.0010	+.0010	-.0010	-.0020	-.0010	-.0020	.0020	.0030
060	-.0010	-.0010	.0010	.0010	+.0010	+.0010	-.0010	-.0020	-.0010	-.0020	.0020	.0030
065	-.0010	-.0010	.0010	.0010	+.0010	+.0010	-.0010	-.0020	-.0010	-.0020	.0020	.0030
070	-.0010	-.0012	.0010	.0010	+.0010	+.0012	-.0010	-.0020	-.0012	-.0024	.0024	.0034
075	-.0012	-.0012	.0012	.0012	+.0012	+.0012	-.0012	-.0024	-.0012	-.0024	.0024	.0034
080	-.0012	-.0012	.0012	.0012	+.0012	+.0012	-.0012	-.0024	-.0012	-.0024	.0024	.0034
090	-.0012	-.0012	.0012	.0012	+.0012	+.0012	-.0012	-.0024	-.0012	-.0024	.0024	.0034
100	-.0014	-.0014	.0014	.0014	+.0014	+.0014	-.0014	-.0028	-.0014	-.0028	.0028	.0038
110	-.0014	-.0014	.0014	.0014	+.0014	+.0014	-.0014	-.0028	-.0014	-.0028	.0028	.0038
120	-.0014	-.0014	.0014	.0014	+.0014	+.0014	-.0014	-.0028	-.0014	-.0028	.0028	.0038
140	-.0014	-.0014	.0014	.0014	+.0014	+.0014	-.0014	-.0028	-.0014	-.0028	.0028	.0038
160	-.0016	-.0016	.0016	.0016	+.0016	+.0016	-.0016	-.0032	-.0016	-.0032	.0032	.0042
180	-.0016	-.0016	.0016	.0016	+.0016	+.0016	-.0016	-.0032	-.0016	-.0032	.0032	.0042
200	-.0018	-.0018	.0018	.0018	+.0018	+.0018	-.0018	-.0036	-.0018	-.0036	.0036	.0046
210	-.0018	-.0018	.0018	.0018	+.0018	+.0018	-.0018	-.0036	-.0018	-.0036	.0036	.0046
220	-.0018	-.0018	.0018	.0018	+.0018	+.0018	-.0018	-.0036	-.0018	-.0036	.0036	.0046
250	-.0018	-.0018	.0018	.0018	+.0018	+.0018	-.0018	-.0036	-.0018	-.0036	.0036	.0046
300	-.0018	-.0018	.0018	.0018	+.0018	+.0018	-.0018	-.0036	-.0018	-.0036	.0036	.0046
350	-.0020	-.0020	.0020	.0020	+.0020	+.0020	-.0020	-.0040	-.0020	-.0040	.0040	.0050
400	-.0020	-.0020	.0020	.0020	+.0020	+.0020	-.0020	-.0040	-.0020	-.0040	.0040	.0050

* Diametral clearance after installation theoretically can range rather widely if all contributing bearing, housing, and shaft tolerances are at either of their extremes. Diametral clearances shown do not apply to Type A (angular contact) bearings.

Listed shaft and housing diameters are for steel supports with standard bearing diametral clearance. Recommended shaft and housing diameters can change greatly based on orientation, temperature, speed, non-standard diametral clearances, and desired performance characteristics. Contact Kaydon for design assistance when required.

Total Width Tolerance—Duplexed Type A Bearings:
 Up thru 12" Bearing Bore +.000 -0.010
 Over 12" Bearing Bore +.000 -0.020
 Race Width Tolerance—Single Type C, X, A Bearings:
 Up thru 12" Bearing Bore +.000 -0.005
 Over 12" Bearing Bore +.000 -0.010

All dimensions in inches.

Precision Tolerances and Recommended Fits for Reali-Slim Bearings (continued)

Type C, X and A – Precision Class 3 (Ref. ABEC 3F)												
Bearing Size (Inch Series)	Bearing Diameters		Radial & Axial Runout		Rotating Shaft or Duplex DF Mounting		Stationary Shaft or Duplex DB Mounting			Bearing Diametral Clearance* (Type "X" and "C" only) Before Installation		
	Bearing Bore Nominal +.0000	Bearing O.D. Nominal +.0000	Inner Race	Outer Race	Shaft Diameter Nominal –.0000	Housing Bore Nominal –.0000	Shaft Diameter Nominal	Housing Bore Nominal				
010	-.0002	-.0003	.0003	.0004	+0.0002	+0.0003	-.0002	-.0004	-.0003	-.0006	.0007	.0011
015	-.0003	-.0003	.0004	.0004	+0.0003	+0.0003	-.0003	-.0006	-.0003	-.0006	.0008	.0012
017	-.0004	-.0004	.0004	.0005	+0.0004	+0.0004	-.0004	-.0008	-.0004	-.0008	.0008	.0018
020	-.0004	-.0004	.0004	.0005	+0.0004	+0.0004	-.0004	-.0008	-.0004	-.0008	.0008	.0018
025	-.0004	-.0004	.0004	.0005	+0.0004	+0.0004	-.0004	-.0008	-.0004	-.0008	.0008	.0018
030	-.0004	-.0004	.0004	.0006	+0.0004	+0.0004	-.0004	-.0008	-.0004	-.0008	.0008	.0018
035	-.0005	-.0004	.0005	.0006	+0.0005	+0.0004	-.0005	-.0010	-.0004	-.0008	.0010	.0020
040	-.0005	-.0004	.0005	.0006	+0.0005	+0.0004	-.0005	-.0010	-.0004	-.0008	.0010	.0020
042	-.0005	-.0005	.0005	.0008	+0.0005	+0.0005	-.0005	-.0010	-.0005	-.0010	.0010	.0020
045	-.0005	-.0005	.0005	.0008	+0.0005	+0.0005	-.0005	-.0010	-.0005	-.0010	.0010	.0020
047	-.0006	-.0005	.0006	.0008	+0.0006	+0.0005	-.0006	-.0012	-.0005	-.0010	.0012	.0022
050	-.0006	-.0005	.0006	.0008	+0.0006	+0.0005	-.0006	-.0012	-.0005	-.0010	.0012	.0022
055	-.0006	-.0006	.0006	.0009	+0.0006	+0.0006	-.0006	-.0012	-.0006	-.0012	.0012	.0022
060	-.0006	-.0006	.0006	.0009	+0.0006	+0.0006	-.0006	-.0012	-.0006	-.0012	.0012	.0022
065	-.0006	-.0006	.0006	.0009	+0.0006	+0.0006	-.0006	-.0012	-.0006	-.0012	.0012	.0022
070	-.0006	-.0007	.0006	.0010	+0.0006	+0.0007	-.0006	-.0012	-.0007	-.0014	.0014	.0024
075	-.0007	-.0007	.0008	.0010	+0.0007	+0.0007	-.0007	-.0014	-.0007	-.0014	.0014	.0024
080	-.0007	-.0007	.0008	.0010	+0.0007	+0.0007	-.0007	-.0014	-.0007	-.0014	.0014	.0024
090	-.0007	-.0007	.0008	.0010	+0.0007	+0.0007	-.0007	-.0014	-.0007	-.0014	.0014	.0024
100	-.0008	-.0008	.0010	.0012	+0.0008	+0.0008	-.0008	-.0016	-.0008	-.0016	.0016	.0026
110	-.0008	-.0008	.0010	.0012	+0.0008	+0.0008	-.0008	-.0016	-.0008	-.0016	.0016	.0026
120	-.0008	-.0009	.0010	.0014	+0.0008	+0.0009	-.0008	-.0016	-.0009	-.0018	.0018	.0028
140	-.0008	-.0009	.0012	.0014	+0.0008	+0.0009	-.0008	-.0016	-.0009	-.0018	.0018	.0028
160	-.0009	-.0010	.0014	.0016	+0.0009	+0.0010	-.0009	-.0018	-.0010	-.0020	.0020	.0030
180	-.0009	-.0010	.0014	.0016	+0.0009	+0.0010	-.0009	-.0018	-.0010	-.0020	.0020	.0030
200	-.0010	-.0012	.0016	.0018	+0.0010	+0.0012	-.0010	-.0020	-.0012	-.0024	.0024	.0034

* Diametral clearance after installation theoretically can range rather widely if all contributing bearing, housing, and shaft tolerances are at either of their extremes. Diametral clearances shown do not apply to Type A (angular contact) bearings.

Listed shaft and housing diameters are for steel supports with standard bearing diametral clearance. Recommended shaft and housing diameters can change greatly based on orientation, temperature, speed, non-standard diametral clearances, and desired performance characteristics. Contact Kaydon for design assistance when required.

Total Width Tolerance—Duplexed Type A Bearings:
 Up thru 12" Bearing Bore +0.000 –0.010
 Over 12" Bearing Bore +0.000 –0.020
 Race Width Tolerance—Single Type C, X, A Bearings:
 Up thru 12" Bearing Bore +0.000 –0.005
 Over 12" Bearing Bore +0.000 –0.010

All dimensions in inches.

Precision Tolerances and Recommended Fits for Real-Slim Bearings (continued)

Section 2 Selection Tables

Type C, X and A – Precision Class 4 (Ref. ABEC 5F)														
Bearing Size (Inch Series)	Bearing Diameters		Radial & Axial Runout				Rotating Shaft or Duplex DF Mounting		Stationary Shaft or Duplex DB Mounting			Bearing Diametral Clearance* (Type "X" and "C" only) Before Installation		
	Bearing Bore Nominal +.0000	Bearing O.D. Nominal +.0000	Inner Race		Outer Race		Shaft Diameter Nominal -.0000	Housing Bore Nominal -.0000	Shaft Diameter Nominal	Housing Bore Nominal				
			Radial	Axial	Radial	Axial								
010	-.0002	-.0002	.0002	.0003	.0002	.0003	+.0002	+.0002	-.0002	-.0004	-.0002	-.0004	.0005	.0009
015	-.0002	-.0002	.0002	.0003	.0002	.0003	+.0002	+.0002	-.0002	-.0004	-.0002	-.0004	.0005	.0009
017	-.0003	-.0003	.0002	.0003	.0003	.0004	+.0003	+.0003	-.0003	-.0006	-.0003	-.0006	.0006	.0012
020	-.0003	-.0003	.0002	.0003	.0003	.0004	+.0003	+.0003	-.0003	-.0006	-.0003	-.0006	.0006	.0012
025	-.0003	-.0003	.0002	.0003	.0003	.0004	+.0003	+.0003	-.0003	-.0006	-.0003	-.0006	.0006	.0012
030	-.0003	-.0003	.0002	.0003	.0004	.0005	+.0003	+.0003	-.0003	-.0006	-.0003	-.0006	.0006	.0012
035	-.0003	-.0003	.0003	.0004	.0004	.0005	+.0003	+.0003	-.0003	-.0006	-.0003	-.0006	.0006	.0012
040	-.0003	-.0003	.0003	.0004	.0004	.0005	+.0003	+.0003	-.0003	-.0006	-.0003	-.0006	.0006	.0012
042	-.0003	-.0004	.0003	.0004	.0004	.0005	+.0003	+.0004	-.0003	-.0006	-.0004	-.0008	.0008	.0014
045	-.0003	-.0004	.0003	.0004	.0004	.0005	+.0003	+.0004	-.0003	-.0006	-.0004	-.0008	.0008	.0014
047	-.0004	-.0004	.0003	.0004	.0004	.0005	+.0004	+.0004	-.0004	-.0008	-.0004	-.0008	.0008	.0014
050	-.0004	-.0004	.0003	.0004	.0004	.0005	+.0004	+.0004	-.0004	-.0008	-.0004	-.0008	.0008	.0014
055	-.0004	-.0005	.0003	.0004	.0005	.0006	+.0004	+.0005	-.0004	-.0008	-.0005	-.0010	.0010	.0016
060	-.0004	-.0005	.0003	.0004	.0005	.0006	+.0004	+.0005	-.0004	-.0008	-.0005	-.0010	.0010	.0016
065	-.0004	-.0005	.0003	.0004	.0005	.0006	+.0004	+.0005	-.0004	-.0008	-.0005	-.0010	.0010	.0016
070	-.0004	-.0005	.0003	.0004	.0005	.0006	+.0004	+.0005	-.0004	-.0008	-.0005	-.0010	.0010	.0016
075	-.0005	-.0005	.0004	.0005	.0005	.0006	+.0005	+.0005	-.0005	-.0010	-.0005	-.0010	.0010	.0016
080	-.0005	-.0005	.0004	.0005	.0005	.0006	+.0005	+.0005	-.0005	-.0010	-.0005	-.0010	.0010	.0016
090	-.0005	-.0005	.0004	.0005	.0005	.0006	+.0005	+.0005	-.0005	-.0010	-.0005	-.0010	.0010	.0016
100	-.0005	-.0005	.0005	.0006	.0006	.0007	+.0005	+.0005	-.0005	-.0010	-.0005	-.0010	.0010	.0016
110	-.0005	-.0005	.0005	.0006	.0006	.0007	+.0005	+.0005	-.0005	-.0010	-.0005	-.0010	.0010	.0016
120	-.0005	-.0006	.0005	.0006	.0007	.0008	+.0005	+.0006	-.0005	-.0010	-.0006	-.0012	.0012	.0018
140	-.0006	-.0006	.0005	.0007	.0007	.0008	+.0006	+.0006	-.0006	-.0012	-.0006	-.0012	.0012	.0018
160	-.0006	-.0007	.0007	.0008	.0008	.0009	+.0006	+.0007	-.0006	-.0012	-.0007	-.0014	.0014	.0020
180	-.0006	-.0007	.0007	.0008	.0008	.0009	+.0006	+.0007	-.0006	-.0012	-.0007	-.0014	.0014	.0020
200	-.0007	-.0008	.0008	.0009	.0009	.0010	+.0007	+.0008	-.0006	-.0014	-.0007	-.0016	.0016	.0022

* Diametral clearance after installation theoretically can range rather widely if all contributing bearing, housing, and shaft tolerances are at either of their extremes. Diametral clearances shown do not apply to Type A (angular contact) bearings.

Listed shaft and housing diameters are for steel supports with standard bearing diametral clearance. Recommended shaft and housing diameters can change greatly based on orientation, temperature, speed, non-standard diametral clearances, and desired performance characteristics. Contact Kaydon for design assistance when required.

Total Width Tolerance—Duplexed Type A Bearings:
 Up thru 12" Bearing Bore +.000 -.010
 Over 12" Bearing Bore +.000 -.020
 Race Width Tolerance—Single Type C, X, A Bearings:
 Up thru 12" Bearing Bore +.000 -.005
 Over 12" Bearing Bore +.000 -.010

All dimensions in inches.

Precision Tolerances and Recommended Fits for Reali-Slim Bearings (continued)

Type C, X and A – Precision Class 6 (Ref. ABEC 7F)												
Bearing Size (Inch Series)	Bearing Diameters		Radial & Axial Runout		Rotating Shaft or Duplex DF Mounting		Stationary Shaft or Duplex DB Mounting			Bearing Diametral Clearance* (Type "X" and "C" only) Before Installation		
	Bearing Bore Nominal +.0000	Bearing O.D. Nominal +.0000	Inner Race	Outer Race	Shaft Diameter Nominal -.0000	Housing Bore Nominal -.0000	Shaft Diameter Nominal	Housing Bore Nominal				
010	-.00015	-.0002	.00015	.0002	+0.00015	+0.0002	-.00015	-.0003	-.0002	-.0004	.0004	.0008
015	-.0002	-.0002	.00015	.0002	+0.0002	+0.0002	-.0002	-.0004	-.0002	-.0004	.0004	.0008
017	-.0002	-.0002	.00015	.0002	+0.0002	+0.0002	-.0002	-.0004	-.0002	-.0004	.0004	.0010
020	-.0002	-.0002	.00015	.0002	+0.0002	+0.0002	-.0002	-.0004	-.0002	-.0004	.0004	.0010
025	-.0002	-.0002	.00015	.0002	+0.0002	+0.0002	-.0002	-.0004	-.0002	-.0004	.0004	.0010
030	-.0002	-.0003	.00015	.0002	+0.0002	+0.0003	-.0002	-.0004	-.0003	-.0006	.0006	.0012
035	-.00025	-.0003	.0002	.0002	+0.00025	+0.0003	-.00025	-.0005	-.0003	-.0006	.0006	.0012
040	-.00025	-.0003	.0002	.0002	+0.00025	+0.0003	-.00025	-.0005	-.0003	-.0006	.0006	.0012
042	-.00025	-.0004	.0002	.0003	+0.00025	+0.0004	-.00025	-.0005	-.0004	-.0008	.0008	.0014
045	-.00025	-.0004	.0002	.0003	+0.00025	+0.0004	-.00025	-.0005	-.0004	-.0008	.0008	.0014
047	-.0003	-.0004	.0003	.0003	+0.0003	+0.0004	-.0003	-.0006	-.0004	-.0008	.0008	.0014
050	-.0003	-.0004	.0003	.0003	+0.0003	+0.0004	-.0003	-.0006	-.0004	-.0008	.0008	.0014
055	-.0003	-.0004	.0003	.0003	+0.0003	+0.0004	-.0003	-.0006	-.0004	-.0008	.0008	.0014
060	-.0003	-.0004	.0003	.0003	+0.0003	+0.0004	-.0003	-.0006	-.0004	-.0008	.0008	.0014
065	-.0003	-.0004	.0003	.0003	+0.0003	+0.0004	-.0003	-.0006	-.0004	-.0008	.0008	.0014
070	-.0003	-.0004	.0003	.0004	+0.0003	+0.0004	-.0003	-.0006	-.0004	-.0008	.0008	.0014
075	-.0004	-.0004	.0003	.0004	+0.0004	+0.0004	-.0004	-.0008	-.0004	-.0008	.0008	.0014
080	-.0004	-.0004	.0003	.0004	+0.0004	+0.0004	-.0004	-.0008	-.0004	-.0008	.0008	.0014
090	-.0004	-.0004	.0003	.0004	+0.0004	+0.0004	-.0004	-.0008	-.0004	-.0008	.0008	.0014
100	-.0005	-.0005	.0004	.0004	+0.0005	+0.0005	-.0005	-.0010	-.0005	-.0010	.0010	.0016
110	-.0005	-.0005	.0004	.0004	+0.0005	+0.0005	-.0005	-.0010	-.0005	-.0010	.0010	.0016
120	-.0005	-.0005	.0004	.0005	+0.0005	+0.0005	-.0005	-.0010	-.0005	-.0010	.0010	.0016
140	-.0005	-.0006	.0004	.0005	+0.0005	+0.0006	-.0005	-.0010	-.0006	-.0012	.0012	.0018

* Diametral clearance after installation theoretically can range rather widely if all contributing bearing, housing, and shaft tolerances are at either of their extremes. Diametral clearances shown do not apply to Type A (angular contact) bearings.

Listed shaft and housing diameters are for steel supports with standard bearing diametral clearance. Recommended shaft and housing diameters can change greatly based on orientation, temperature, speed, non-standard diametral clearances, and desired performance characteristics. Contact Kaydon for design assistance when required.

Total Width Tolerance—Duplexed Type A Bearings:
 Up thru 12" Bearing Bore +.000 –.010
 Over 12" Bearing Bore +.000 –.020

Race Width Tolerance—Single Type C, X, A Bearings:
 Up thru 12" Bearing Bore +.000 –.005
 Over 12" Bearing Bore +.000 –.010

All dimensions in inches.

Endurakote Plating for Corrosion-Resistant Bearings (Series L, N)

Introduction

Endurakote plating protects bearings from corrosion and provides substantial life improvements in hostile environments. Endurakote plating is applied over conventional bearing materials such as AISI 52100 steel, and offers the benefit of corrosion resistance normally found only in stainless steel bearings. The coating is applied to each entire bearing race ring, including the paths, thus leaving no area exposed. Other commercial chrome or cadmium coatings normally accepted and used cannot be applied to the path due to the rolling contact stresses. Endurakote plating is hard chromium, electrodeposited by a proprietary process which achieves a true molecular bond, and will not flake or peel even under the high contact stresses experienced in the bearing paths.

Laboratory and field testing results have proven the benefits of this process. Severe salt spray testing has shown that bearings with Endurakote plating withstand corrosion as well as or better than AISI 440C stainless steel. The hard, dense exterior surface formed by the coating is extremely wear resistant and is excellent in the retention of the lubricant film. Conventional life testing of AISI 52100 steel bearings with Endurakote plating has shown that no life de-rating is necessary. In fact, the extremely hard surface of Endurakote plating protects the bearing from surface generated damage which can promote premature failure. Since the coating is capable of withstanding extremely high temperatures, the bearings are limited by the bearing materials or lubricant used.

The coating used for Endurakote plating can be applied to any type of bearing and to most bearing materials. Its primary advantage is to utilize stock materials such as AISI 52100, etc. with their economies, and convert them to wear and corrosion resistant bearings. This is particularly beneficial for larger diameter bearings or where quick delivery is critical. Thus, cost savings can be achieved over more exotic or specialized materials. Also, stock bearings can have Endurakote plating applied for quick delivery.

The net result is that we can offer bearings with the capacity of conventional bearing steels and the corrosion resistance of AISI 440C stainless steel from standard AISI 52100 stock components.

Application

Endurakote plating provides corrosion resistance and is effective in increasing wear resistance in sliding surface contacts such as the lands where the cage pilots. The micro-surface composition of Endurakote plating aids in lubricant dispersion, enhancing base metals to the degree of reducing or eliminating galling, seizing, and high friction, over a wide range of installations and environments.

Advantages

Endurakote plating effects a buildup of less than .0002 under normal circumstances. Thus, it can often be applied to stock bearing components which have been specially selected. Endurakote plating is compatible with most ferrous and nonferrous metal, allowing maximum flexibility in selection of base material. Endurakote plating is normally a final process, and its quality is constant with any given base metal, insuring design reproducibility.

Properties and Characteristics

A. Hardness

Endurakote plating, as deposited, has an equivalent hardness in excess of 70 Rockwell "C." When measured by conventional micro-hardness methods, the host material will modify this measurement to some degree.

B. Coefficient of Friction

(Note: Measurements made at 72°F, using other materials for comparison.)

Material	Against Material	Static	—	Sliding
Steel	Steel	0.30	—	0.20
Steel	Brass, Bronze	0.25	—	0.20
Steel	Endurakote plating	0.17	—	0.16
Brass, Bronze	Endurakote plating	0.15	—	0.13
Endurakote	Endurakote plating	0.14	—	0.12

Endurakote Plating (continued)

C. Adhesion

Endurakote plating will not flake, crack, chip, peel or otherwise separate from the base material under standard bend tests or under conditions where severe heat is induced. The adherence is adequate to withstand the extremely high compressive stresses in the contact areas of ball and roller bearings.

D. Effect On Base

The purity of the chromium surface will not be less than 99% as deposited. A comprehensive testing program at Kaydon established that bearings with Endurakote plating exhibited load carrying capacities and life expectancy equal to or better than uncoated AISI 52100 steel bearings.

E. Corrosion Resistance

Endurakote plating resists attack by most organic and inorganic compounds with a pH within the range of 4 and 11, except sulfuric and hydrochloric acids. Porosity of the base metal, compound concentration and exposure time to the compound become corrosion factors, but Endurakote plating greatly enhances the base material. In severe salt spray tests as well as tap water immersion tests, AISI 52100 steel with Endurakote plating proved equal to fully hardened AISI 440C stainless steel in resistance to rusting. In many instances, Endurakote plating is better for corrosion protection than cadmium plate, zinc plate, phosphates, chromates, black oxide or normal chrome plate. We invite inquiries about this and will be pleased to arrange tests to qualify Endurakote plating for specific environments.

F. Heat Resistance

Reali-Slim bearings with Endurakote plating are designed to maintain their operating characteristics over a temperature range from -65°F to 250°F.

G. Surface Quality

Endurakote plating conforms to the texture of the existing surface. Ra finish will be improved slightly down to about 8 Ra; below 4 Ra there is little change. Endurakote plating has a matte or micro-orange peel surface with very good lubricant retention qualities.

H. Food Industries

Endurakote plating is used on food processing equipment.

I. Load Capacity

Endurakote plating does not affect the static or dynamic load capacity of the bearing. These values can be found by looking up the corresponding part number — starting with “K” — in the standard Reali-Slim bearing tables.

Bearing Size Capabilities

Endurakote plating can be applied to any Reali-Slim bearing.

Restrictions

Kaydon does not recommend the use of Endurakote plating in any low torque or torque-sensitive applications.

Open Endurakote-Plated Endura-Slim® Bearing Selections

Type A – ANGULAR CONTACT

A deep groove bearing with reduced shoulder on one side of inner or outer race ball path. Snap-over assembly permits use of a one-piece circular pocket ring separator and greater ball complement. These bearings will accept radial load and single direction thrust load and are normally used in conjunction with another bearing of similar construction. Type A bearings require

the application of thrust to establish contact angle. Stock bearings are individual units and when purchased as such must be adjusted at installation to desired running clearance or preload. Matched sets are available. Kaydon also offers matched spacers for applications requiring extra precision.

NAA Series											
KAYDON Bearing Number	Dimensions in Inches					Capacities in Pounds ^①					Approx. Wt. in lbs.
	Size		Land Diameters			Dynamic			Static ^②		
	Bore	Outside Dia.	L ₁	L ₂	C'Bore L ₃	KAYDON Radial	ISO Radial ^③	Thrust	Radial	Thrust	
NAA10AGO	1.0000	1.3752	1.140	1.235	1.274	194	590	450	340	970	.025
NAA15AGO	1.5000	1.8752	1.640	1.735	1.774	238	681	560	480	1,380	.038
NAA17AGO	1.7500	2.1252	1.890	1.985	2.024	251	697	600	530	1,520	.045

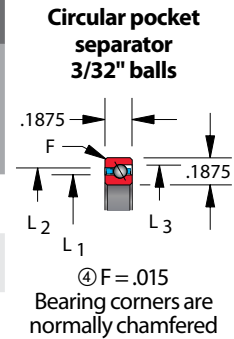

NA Series											
KAYDON Bearing Number	Dimensions in Inches					Capacities in Pounds ^①					Approx. Wt. in lbs.
	Size		Land Diameters			Dynamic			Static ^②		
	Bore	Outside Dia.	L ₁	L ₂	C'Bore L ₃	KAYDON Radial	ISO Radial ^③	Thrust	Radial	Thrust	
NA020AR0	2.0000	2.5002	2.186	2.314	2.369	405	1,065	960	790	2,280	.10
NA025AR0	2.5000	3.0002	2.686	2.814	2.869	459	1,150	1,100	960	2,780	.12
NA030AR0	3.0000	3.5002	3.186	3.314	3.367	507	1,225	1,230	1,140	3,290	.14
NA035AR0	3.5000	4.0002	3.686	3.814	3.867	552	1,292	1,350	1,310	3,790	.17
NA040AR0	3.9998	4.5003	4.186	4.314	4.367	595	1,353	1,470	1,490	4,300	.19
NA042AR0	4.2498	4.7503	4.436	4.564	4.615	616	1,382	1,530	1,580	4,550	.20
NA045AR0	4.4998	5.0003	4.686	4.814	4.865	637	1,410	1,580	1,660	4,810	.21
NA047AR0	4.7498	5.2503	4.936	5.064	5.115	657	1,437	1,640	1,750	5,060	.22
NA050AR0	4.9998	5.5003	5.186	5.314	5.365	676	1,463	1,690	1,840	5,310	.23
NA055AR0	5.4998	6.0003	5.686	5.814	5.863	715	1,513	1,800	2,020	5,820	.25
NA060AR0	5.9998	6.5003	6.186	6.314	6.363	752	1,561	1,900	2,190	6,320	.28
NA065AR0	6.4998	7.0003	6.686	6.814	6.861	788	1,605	2,000	2,370	6,830	.30
NA070AR0	6.9998	7.5003	7.186	7.314	7.361	823	1,648	2,100	2,540	7,340	.32
NA075AR0	7.4998	8.0003	7.686	7.814	7.861	857	1,689	2,190	2,720	7,840	.34
NA080AR0	7.9998	8.5003	8.186	8.314	8.359	890	1,728	2,280	2,890	8,350	.36
NA090AR0	8.9998	9.5003	9.186	9.314	9.357	954	1,802	2,470	3,240	9,360	.41
NA100AR0	9.9998	10.5003	10.186	10.314	10.355	1,014	1,871	2,640	3,590	10,370	.45
NA110AR0	10.9998	11.5003	11.186	11.314	11.353	1,072	1,936	2,810	3,940	11,380	.50
NA120AR0	11.9998	12.5003	12.186	12.314	12.349	1,128	1,998	2,970	4,290	12,390	.54

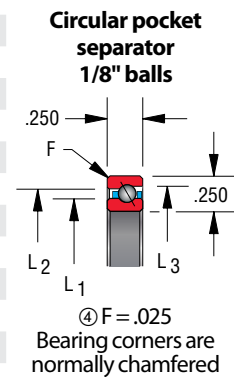

① Capacities listed are not simultaneous. For combined loading see discussion of [Bearing Selection](#) and [Load Analysis](#). Dynamic capacities are based upon 1 million revolutions of L10 life. Published capacities do not apply to hybrid series bearings P, X, and Y - contact Kaydon product engineering for values.

② Static capacities are non-brinell limits based on rigid support from the shaft and housing.

③ ISO Radial ratings are calculated per ISO 281:1990. They are included for comparison only (refer to [Page 95](#)).

④ "F" is the maximum shaft or housing fillet radius the bearing corners will clear.

Type A – Open Endurakote-Plated Endura-Slim Bearings, ANGULAR CONTACT

NB Series											
KAYDON Bearing Number	Dimensions in Inches					Capacities in Pounds ^①					Approx. Wt. in lbs.
	Size		Land Diameters			Dynamic			Static ^②		
	Bore	Outside Dia.	L ₁	L ₂	C'Bore L ₃	KAYDON Radial	ISO Radial ^③	Thrust	Radial	Thrust	
NB020ARO	2.0000	2.6252	2.231	2.393	2.464	601	1,520	1,380	1,090	3,150	.15
NB025ARO	2.5000	3.1252	2.731	2.893	2.964	675	1,650	1,590	1,340	3,860	.19
NB030ARO	3.0000	3.6252	3.231	3.393	3.462	734	1,737	1,750	1,550	4,470	.22
NB035ARO	3.5000	4.1252	3.731	3.893	3.962	801	1,840	1,930	1,790	5,180	.27
NB040ARO	3.9998	4.6253	4.231	4.393	4.460	865	1,934	2,100	2,040	5,890	.30
NB042ARO	4.2498	4.8753	4.481	4.643	4.710	891	1,967	2,170	2,150	6,200	.31
NB045ARO	4.4998	5.1253	4.731	4.893	4.960	917	2,000	2,240	2,250	6,500	.34
NB047ARO	4.7498	5.3753	4.981	5.143	5.210	951	2,051	2,340	2,390	6,910	.35
NB050ARO	4.9998	5.6253	5.231	5.393	5.460	976	2,081	2,410	2,500	7,210	.37
NB055ARO	5.4998	6.1253	5.731	5.893	5.958	1,033	2,158	2,560	2,740	7,920	.40
NB060ARO	5.9998	6.6253	6.231	6.393	6.458	1,088	2,230	2,710	2,990	8,630	.44
NB065ARO	6.4998	7.1253	6.731	6.893	6.958	1,132	2,281	2,840	3,200	9,240	.47
NB070ARO	6.9998	7.6253	7.231	7.393	7.456	1,184	2,347	2,980	3,450	9,960	.50
NB075ARO	7.4998	8.1253	7.731	7.893	7.955	1,235	2,409	3,120	3,700	10,670	.54
NB080ARO	7.9998	8.6253	8.231	8.393	8.453	1,284	2,469	3,260	3,940	11,380	.57
NB090ARO	8.9998	9.6253	9.231	9.393	9.451	1,370	2,568	3,510	4,400	12,700	.64
NB100ARO	9.9998	10.6253	10.231	10.393	10.449	1,461	2,673	3,760	4,890	14,120	.71
NB110ARO	10.9998	11.6253	11.231	11.393	11.447	1,540	2,760	4,000	5,350	15,440	.78
NB120ARO	11.9998	12.6253	12.231	12.393	12.445	1,623	2,853	4,240	5,840	16,860	.85
NB140ARO	13.9998	14.6253	14.231	14.393	14.439	1,767	3,005	4,670	6,760	19,500	.98
NB160ARO	15.9998	16.6253	16.231	16.393	16.433	1,907	3,154	5,100	7,710	22,250	1.12
NB180ARO	17.9998	18.6253	18.231	18.393	18.425	2,038	3,292	5,510	8,660	24,990	1.26
NB200ARO	19.9998	20.6253	20.231	20.393	20.416	2,162	3,421	5,900	9,610	27,730	1.40

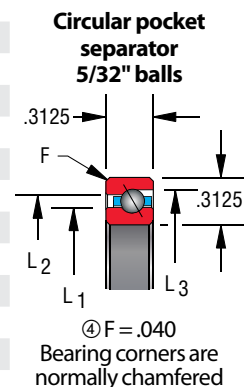

① Capacities listed are not simultaneous. For combined loading see discussion of Bearing Selection and Load Analysis. Dynamic capacities are based upon 1 million revolutions of L10 life. Published capacities do not apply to hybrid series bearings P, X, and Y - contact Kaydon product engineering for values.

② Static capacities are non-brinell limits based on rigid support from the shaft and housing.

③ ISO Radial ratings are calculated per ISO 281:1990. They are included for comparison only (refer to Page 95).

④ "F" is the maximum shaft or housing fillet radius the bearing corners will clear.

CONTACT Kaydon at —

Kaydon Bearings • Muskegon, Michigan 49443
Telephone: 231-755-3741 • Fax: 231-759-4102



Need Service Fast?

1-800-514-3066

www.kaydonbearings.com



Type A – Open Endurakote-Plated Endura-Slim Bearings, ANGULAR CONTACT

Selection Tables

Section 2

NC Series											
KAYDON Bearing Number	Dimensions in Inches					Capacities in Pounds ^①					Approx. Wt. in lbs.
	Size		Land Diameters			Dynamic			Static ^②		
	Bore	Outside Dia.	L ₁	L ₂	C'Bore L ₃	KAYDON Radial	ISO Radial ^③	Thrust	Radial	Thrust	
NC040AR0	3.9998	4.7503	4.277	4.473	4.554	1,153	2,520	2,770	2,550	7,360	.44
NC042AR0	4.2498	5.0003	4.527	4.723	4.804	1,194	2,580	2,880	2,710	7,820	.46
NC045AR0	4.4998	5.2503	4.777	4.973	5.052	1,234	2,637	2,990	2,860	8,270	.49
NC047AR0	4.7498	5.5003	5.027	5.223	5.302	1,274	2,693	3,100	3,020	8,720	.51
NC050AR0	4.9998	5.7503	5.277	5.473	5.552	1,313	2,746	3,200	3,180	9,170	.54
NC055AR0	5.4998	6.2503	5.777	5.973	6.052	1,374	2,820	3,370	3,440	9,920	.58
NC060AR0	5.9998	6.7503	6.277	6.473	6.550	1,448	2,917	3,580	3,750	10,820	.64
NC065AR0	6.4998	7.2503	6.777	6.973	7.050	1,519	3,009	3,770	4,060	11,720	.68
NC070AR0	6.9998	7.7503	7.277	7.473	7.550	1,575	3,071	3,930	4,320	12,470	.74
NC075AR0	7.4998	8.2503	7.777	7.973	8.048	1,642	3,156	4,120	4,630	13,380	.78
NC080AR0	7.9998	8.7503	8.277	8.473	8.548	1,708	3,236	4,300	4,950	14,280	.84
NC090AR0	8.9998	9.7503	9.277	9.473	9.546	1,822	3,366	4,630	5,520	15,930	.98
NC100AR0	9.9998	10.7503	10.277	10.473	10.544	1,942	3,508	4,970	6,140	17,730	1.04
NC110AR0	10.9998	11.7503	11.277	11.473	11.542	2,047	3,621	5,280	6,720	19,390	1.14
NC120AR0	11.9998	12.7503	12.277	12.473	12.540	2,147	3,729	5,570	7,290	21,040	1.23
NC140AR0	13.9998	14.7503	14.277	14.473	14.535	2,347	3,946	6,170	8,490	24,500	1.43
NC160AR0	15.9998	16.7503	16.277	16.473	16.529	2,533	4,144	6,730	9,680	27,950	1.63
NC180AR0	17.9998	18.7503	18.277	18.473	18.523	2,707	4,326	7,280	10,880	31,410	1.83
NC200AR0	19.9998	20.7503	20.277	20.473	20.517	2,863	4,484	7,780	12,030	34,720	2.03
NC250AR0	24.9998	25.7503	25.277	25.473	25.500	3,233	4,863	9,010	14,900	43,280	2.52
NC300AR0	29.9998	30.7503	30.277	30.473	30.484	3,561	5,196	10,160	17,960	51,850	3.02

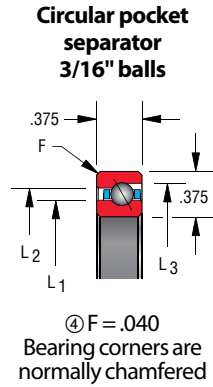

ND Series											
KAYDON Bearing Number	Dimensions in Inches					Capacities in Pounds ^①					Approx. Wt. in lbs.
	Size		Land Diameters			Dynamic			Static ^②		
	Bore	Outside Dia.	L ₁	L ₂	C'Bore L ₃	KAYDON Radial	ISO Radial ^③	Thrust	Radial	Thrust	
ND040AR0	3.9998	5.0003	4.370	4.630	4.741	1,819	3,708	4,260	3,550	10,260	.80
ND042AR0	4.2498	5.2503	4.620	4.880	4.991	1,876	3,786	4,420	3,750	10,830	.84
ND045AR0	4.4998	5.5003	4.870	5.130	5.241	1,931	3,861	4,570	3,950	11,400	.88
ND047AR0	4.7498	5.7503	5.120	5.380	5.490	1,986	3,934	4,720	4,150	11,970	.93
ND050AR0	4.9998	6.0003	5.370	5.630	5.740	2,040	4,004	4,870	4,340	12,540	.98
ND055AR0	5.4998	6.5003	5.870	6.130	6.238	2,145	4,138	5,160	4,740	13,680	1.06
ND060AR0	5.9998	7.0003	6.370	6.630	6.738	2,247	4,264	5,440	5,130	14,820	1.15
ND065AR0	6.4998	7.5003	6.870	7.130	7.236	2,346	4,384	5,720	5,530	15,960	1.24
ND070AR0	6.9998	8.0003	7.370	7.630	7.736	2,442	4,499	5,990	5,920	17,100	1.33
ND075AR0	7.4998	8.5003	7.870	8.130	8.236	2,536	4,608	6,250	6,320	18,240	1.42
ND080AR0	7.9998	9.0003	8.370	8.630	8.734	2,627	4,713	6,510	6,710	19,380	1.52
ND090AR0	8.9998	10.0003	9.370	9.630	9.732	2,803	4,911	7,010	7,500	21,660	1.69
ND100AR0	9.9998	11.0003	10.370	10.630	10.732	2,972	5,096	7,500	8,290	23,940	1.87
ND110AR0	10.9998	12.0003	11.370	11.630	11.730	3,133	5,270	7,960	9,080	26,220	2.05
ND120AR0	11.9998	13.0003	12.370	12.630	12.728	3,288	5,434	8,420	9,870	28,500	2.23
ND140AR0	13.9998	15.0003	14.370	14.630	14.724	3,582	5,739	9,290	11,450	33,060	2.57
ND160AR0	15.9998	17.0003	16.370	16.630	16.718	3,856	6,018	10,130	13,030	37,620	2.93
ND180AR0	17.9998	19.0003	18.370	18.630	18.712	4,113	6,276	10,930	14,610	42,180	3.29
ND200AR0	19.9998	21.0003	20.370	20.630	20.705	4,356	6,517	11,710	16,190	46,740	3.65
ND210AR0	20.9998	22.0003	21.370	21.630	21.700	4,472	6,632	12,086	16,981	49,020	3.83
ND250AR0	24.9998	26.0003	25.370	25.630	25.688	4,908	7,060	13,540	20,140	58,140	4.54
ND300AR0	29.9998	31.0003	30.370	30.630	30.672	5,397	7,538	15,260	24,090	69,540	5.44

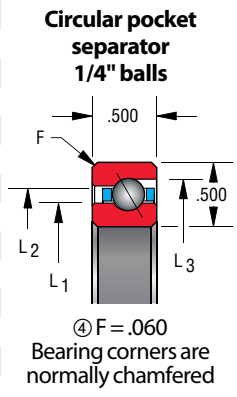

① Capacities listed are not simultaneous. For combined loading see discussion of [Bearing Selection and Load Analysis](#). Dynamic capacities are based upon 1 million revolutions of L10 life. Published capacities do not apply to hybrid series bearings P, X, and Y - contact Kaydon product engineering for values.

② Static capacities are non-brinell limits based on rigid support from the shaft and housing.

③ ISO Radial ratings are calculated per ISO 281:1990. They are included for comparison only (refer to [Page 95](#)).

④ "F" is the maximum shaft or housing fillet radius the bearing corners will clear.

Type A – Open Endurakote-Plated Endura-Slim Bearings, ANGULAR CONTACT

NF Series											
KAYDON Bearing Number	Dimensions in Inches					Capacities in Pounds ^①					Approx. Wt. in lbs.
	Size		Land Diameters			Dynamic			Static ^②		
	Bore	Outside Dia.	L ₁	L ₂	C' Bore L ₃	KAYDON Radial	ISO Radial ^③	Thrust	Radial	Thrust	
NF040ARO	3.9998	5.5003	4.555	4.945	5.115	3,736	6,809	8,420	6,350	18,340	1.92
NF042ARO	4.2498	5.7503	4.805	5.195	5.365	3,805	6,891	8,630	6,600	19,050	2.04
NF045ARO	4.4998	6.0003	5.060	5.445	5.615	3,966	7,134	9,050	7,090	20,460	2.14
NF047ARO	4.7498	6.2503	5.305	5.695	5.865	4,034	7,207	9,260	7,330	21,160	2.26
NF050ARO	4.9998	6.5003	5.555	5.945	6.115	4,101	7,279	9,460	7,570	21,870	2.37
NF055ARO	5.4998	7.0003	6.055	6.445	6.613	4,319	7,566	10,060	8,310	23,980	2.59
NF060ARO	5.9998	7.5003	6.555	6.945	7.113	4,530	7,835	10,650	9,040	26,100	2.72
NF065ARO	6.4998	8.0003	7.055	7.445	7.613	4,734	8,088	11,220	9,770	28,220	2.94
NF070ARO	6.9998	8.5003	7.555	7.945	8.113	4,932	8,329	11,770	10,510	30,330	3.16
NF075ARO	7.4998	9.0003	8.055	8.445	8.610	5,052	8,432	12,130	11,000	31,740	3.39
NF080ARO	7.9998	9.5003	8.555	8.945	9.110	5,242	8,655	12,670	11,730	33,860	3.61
NF090ARO	8.9998	10.5003	9.555	9.945	10.108	5,608	9,073	13,700	13,190	38,090	3.95
NF100ARO	9.9998	11.5003	10.555	10.945	11.106	5,890	9,353	14,530	14,420	41,620	4.40
NF110ARO	10.9998	12.5003	11.555	11.945	12.106	6,227	9,720	15,500	15,880	45,850	4.75
NF120ARO	11.9998	13.5003	12.555	12.945	13.104	6,487	9,969	16,290	17,100	49,380	5.20
NF140ARO	13.9998	15.5003	14.555	14.945	15.102	7,043	10,523	17,950	19,790	57,140	5.76
NF160ARO	15.9998	17.5003	16.555	16.945	17.098	7,563	11,030	19,540	22,480	64,890	6.78
NF180ARO	17.9998	19.5003	18.555	18.945	19.096	8,103	11,573	21,210	25,410	73,360	7.67
NF200ARO	19.9998	21.5003	20.555	20.945	21.092	8,562	12,006	22,680	28,100	81,120	8.47
NF250ARO	24.9998	26.5003	25.555	25.945	26.085	9,585	12,954	26,100	34,700	100,200	10.50
NF300ARO	29.9998	31.5003	30.555	30.945	31.075	10,533	13,848	29,430	41,540	119,900	12.50
NF350ARO	34.9998	36.5003	35.555	35.945	36.064	11,382	14,653	32,580	48,380	139,700	14.60
NF400ARO	39.9998	41.5003	40.555	40.945	41.054	12,147	15,387	35,580	55,220	159,400	16.60

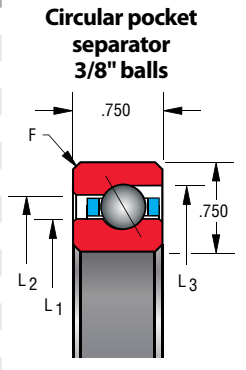

④ F = .080
Bearing corners are normally chamfered

NG Series											
KAYDON Bearing Number	Dimensions in Inches					Capacities in Pounds ^①					Approx. Wt. in lbs.
	Size		Land Diameters			Dynamic			Static ^②		
	Bore	Outside Dia.	L ₁	L ₂	C' Bore L ₃	KAYDON Radial	ISO Radial ^③	Thrust	Radial	Thrust	
NG040ARO	3.9998	6.0003	4.742	5.258	5.491	6,281	10,167	13,630	9,480	27,360	3.61
NG042ARO	4.2498	6.2503	4.992	5.508	5.741	6,438	10,384	14,090	9,950	28,730	3.83
NG045ARO	4.4998	6.5003	5.242	5.758	5.989	6,562	10,592	14,530	10,430	30,100	3.95
NG047ARO	4.7498	6.7503	5.492	6.008	6.239	6,745	10,792	14,970	10,900	31,460	4.17
NG050ARO	4.9998	7.0003	5.742	6.258	6.489	6,897	10,985	15,400	11,370	32,830	4.42
NG055ARO	5.4998	7.5003	6.242	6.758	6.989	7,192	11,352	16,240	12,320	35,570	4.73
NG060ARO	5.9998	8.0003	6.742	7.258	7.489	7,480	11,697	17,060	13,270	38,300	5.07
NG065ARO	6.4998	8.5003	7.242	7.758	7.987	7,761	12,023	17,870	14,220	41,040	5.41
NG070ARO	6.9998	9.0003	7.742	8.258	8.487	8,035	12,333	18,650	15,160	43,780	5.87
NG075ARO	7.4998	9.5003	8.242	8.758	8.987	8,303	12,629	19,420	16,110	46,510	6.20
NG080ARO	7.9998	10.0003	8.742	9.258	9.485	8,566	12,912	20,180	17,060	49,250	6.54
NG090ARO	8.9998	11.0003	9.742	10.258	10.485	9,073	13,446	21,640	18,960	54,720	7.22
NG100ARO	9.9998	12.0003	10.742	11.258	11.483	9,561	13,942	23,060	20,850	60,190	8.00
NG110ARO	10.9998	13.0003	11.742	12.258	12.481	10,027	14,409	24,440	22,750	65,660	8.68
NG120ARO	11.9998	14.0003	12.742	13.258	13.481	10,481	14,849	25,780	24,640	71,140	9.47
NG140ARO	13.9998	16.0003	14.742	15.258	15.478	11,338	15,665	28,360	28,430	82,080	10.90
NG160ARO	15.9998	18.0003	16.742	17.258	17.474	12,142	16,411	30,830	32,220	93,020	12.40
NG180ARO	17.9998	20.0003	18.742	19.258	19.472	12,898	17,101	33,200	36,020	104,000	13.80
NG200ARO	19.9998	22.0003	20.742	21.258	21.468	13,612	17,745	35,490	39,810	114,900	15.20
NG220ARO	21.9998	24.0003	22.742	23.258	23.468	14,290	18,351	37,712	43,598	125,856	16.63
NG250ARO	24.9998	27.0003	25.742	26.258	26.461	15,239	19,198	40,920	49,280	142,300	18.80
NG300ARO	29.9998	32.0003	30.742	31.258	31.451	16,687	20,480	46,020	58,760	169,600	22.50
NG350ARO	34.9998	37.0003	35.742	36.258	36.440	17,982	21,636	50,840	68,240	197,000	26.20
NG400ARO	39.9998	42.0003	40.472	41.258	41.430	19,153	22,693	55,440	77,720	224,400	29.80

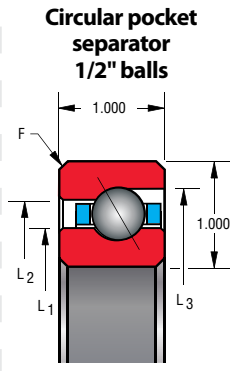

④ F = .080
Bearing corners are normally chamfered

① Capacities listed are not simultaneous. For combined loading see discussion of [Bearing Selection](#) and [Load Analysis](#). Dynamic capacities are based upon 1 million revolutions of L10 life. Published capacities do not apply to hybrid series bearings P, X, and Y - contact Kaydon product engineering for values.
 ② Static capacities are non-brinell limits based on rigid support from the shaft and housing.
 ③ ISO Radial ratings are calculated per ISO 281:1990. They are included for comparison only (refer to [Page 95](#)).
 ④ "F" is the maximum shaft or housing fillet radius the bearing corners will clear.

Open Endurakote-Plated Endura-Slim Bearing Selections

Type C – RADIAL CONTACT

A Conrad assembled bearing designed primarily for application of radial load—deep ball grooves also permit application of

thrust load in either direction – often used in conjunction with another bearing.

NAA Series								
KAYDON Bearing Number	Dimensions in Inches				Capacities in Pounds ^①			Approx. Wt. in lbs.
	Size		Land Diameters		Dynamic		Static ^②	
	Bore	Outside Dia.	L ₁	L ₂	KAYDON Radial	ISO Radial ^③	Radial	
NAA10CLO	1.0000	1.3752	1.140	1.235	188	558	290	.026
NAA15CLO	1.5000	1.8752	1.640	1.735	225	632	400	.039
NAA17CLO	1.7500	2.1252	1.890	1.985	242	663	460	.045

NA Series								
KAYDON Bearing Number	Dimensions in Inches				Capacities in Pounds ^①			Approx. Wt. in lbs.
	Size		Land Diameters		Dynamic		Static ^②	
	Bore	Outside Dia.	L ₁	L ₂	KAYDON Radial	ISO Radial ^③	Radial	
NA020CP0	2.0000	2.5002	2.186	2.314	393	1,012	680	.10
NA025CP0	2.5000	3.0002	2.686	2.814	442	1,094	830	.13
NA030CP0	3.0000	3.5002	3.186	3.314	487	1,166	990	.15
NA035CP0	3.5000	4.0002	3.686	3.814	530	1,230	1,140	.18
NA040CP0	3.9998	4.5003	4.186	4.314	571	1,289	1,290	.19
NA042CP0	4.2498	4.7503	4.436	4.564	591	1,317	1,370	.20
NA045CP0	4.4998	5.0003	4.686	4.814	610	1,344	1,440	.22
NA047CP0	4.7498	5.2503	4.936	5.064	629	1,369	1,520	.23
NA050CP0	4.9998	5.5003	5.186	5.314	648	1,394	1,590	.24
NA055CP0	5.4998	6.0003	5.686	5.814	685	1,442	1,750	.25
NA060CP0	5.9998	6.5003	6.186	6.314	720	1,487	1,900	.28
NA065CP0	6.4998	7.0003	6.686	6.814	754	1,530	2,050	.30
NA070CP0	6.9998	7.5003	7.186	7.314	787	1,571	2,200	.31
NA075CP0	7.4998	8.0003	7.686	7.814	820	1,610	2,350	.34
NA080CP0	7.9998	8.5003	8.186	8.314	851	1,647	2,500	.38
NA090CP0	8.9998	9.5003	9.186	9.314	912	1,718	2,810	.44
NA100CP0	9.9998	10.5003	10.186	10.314	969	1,784	3,110	.50
NA110CP0	10.9998	11.5003	11.186	11.314	1,025	1,846	3,410	.52
NA120CP0	11.9998	12.5003	12.186	12.314	1,078	1,904	3,720	.56

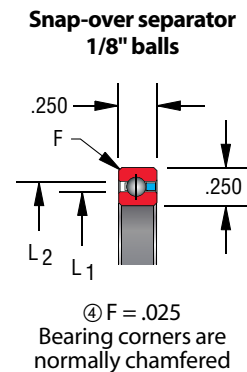
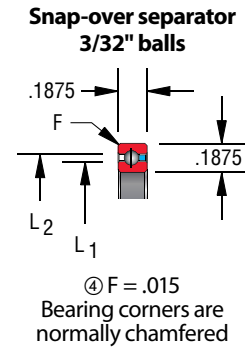

① Capacities listed are not simultaneous. For combined loading see discussion of [Bearing Selection](#) and [Load Analysis](#). Dynamic capacities are based upon 1 million revolutions of L10 life. Published capacities do not apply to hybrid series bearings P, X, and Y - contact Kaydon product engineering for values.

② Static capacities are non-brinell limits based on rigid support from the shaft and housing.

③ ISO Radial ratings are calculated per ISO 281:1990. They are included for comparison only (refer to [Page 95](#)).

④ "F" is the maximum shaft or housing fillet radius the bearing corners will clear.

Type C – Open Endurakote-Plated Endura-Slim Bearings, RADIAL CONTACT

NB Series								
KAYDON Bearing Number	Dimensions in Inches				Capacities in Pounds ^①			Approx. Wt. in lbs.
	Size		Land Diameters		Dynamic		Static ^②	
	Bore	Outside Dia.	L ₁	L ₂	KAYDON Radial	ISO Radial ^③	Radial	
NB020CP0	2.0000	2.6252	2.231	2.393	577	1,431	930	.16
NB025CP0	2.5000	3.1252	2.731	2.893	644	1,549	1,140	.20
NB030CP0	3.0000	3.6252	3.231	3.393	707	1,651	1,340	.24
NB035CP0	3.5000	4.1252	3.731	3.893	767	1,743	1,540	.27
NB040CP0	3.9998	4.6253	4.231	4.393	825	1,827	1,750	.30
NB042CP0	4.2498	4.8753	4.481	4.643	846	1,853	1,830	.31
NB045CP0	4.4998	5.1253	4.731	4.893	880	1,904	1,950	.33
NB047CP0	4.7498	5.3753	4.981	5.143	901	1,928	2,030	.34
NB050CP0	4.9998	5.6253	5.231	5.393	933	1,976	2,150	.38
NB055CP0	5.4998	6.1253	5.731	5.893	984	2,044	2,360	.41
NB060CP0	5.9998	6.6253	6.231	6.393	1,034	2,108	2,560	.44
NB065CP0	6.4998	7.1253	6.731	6.893	1,082	2,168	2,760	.47
NB070CP0	6.9998	7.6253	7.231	7.393	1,129	2,226	2,970	.50
NB075CP0	7.4998	8.1253	7.731	7.893	1,175	2,281	3,170	.53
NB080CP0	7.9998	8.6253	8.231	8.393	1,219	2,334	3,370	.57
NB090CP0	8.9998	9.6253	9.231	9.393	1,304	2,434	3,780	.66
NB100CP0	9.9998	10.6253	10.231	10.393	1,386	2,527	4,190	.73
NB110CP0	10.9998	11.6253	11.231	11.393	1,464	2,615	4,590	.75
NB120CP0	11.9998	12.6253	12.231	12.393	1,539	2,698	5,000	.83
NB140CP0	13.9998	14.6253	14.231	14.393	1,680	2,851	5,810	1.05
NB160CP0	15.9998	16.6253	16.231	16.393	1,812	2,991	6,620	1.20
NB180CP0	17.9998	18.6253	18.231	18.393	1,936	3,121	7,440	1.35
NB200CP0	19.9998	20.6253	20.231	20.393	2,053	3,242	8,250	1.50

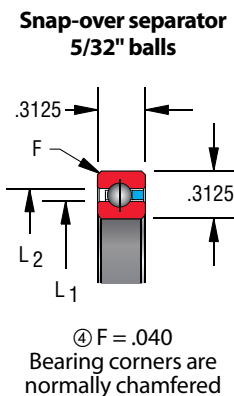

- ① Capacities listed are not simultaneous. For combined loading see discussion of Bearing Selection and Load Analysis. Dynamic capacities are based upon 1 million revolutions of L10 life. Published capacities do not apply to hybrid series bearings P, X, and Y - contact Kaydon product engineering for values.
- ② Static capacities are non-brinell limits based on rigid support from the shaft and housing.
- ③ ISO Radial ratings are calculated per ISO 281:1990. They are included for comparison only (refer to Page 95).
- ④ "F" is the maximum shaft or housing fillet radius the bearing corners will clear.

CONTACT Kaydon at —
Kaydon Bearings • Muskegon, Michigan 49443
Telephone: 231-755-3741 • Fax: 231-759-4102

Need Service Fast?
1-800-514-3066
www.kaydonbearings.com





Type C – Open Endurakote-Plated Endura-Slim Bearings, RADIAL CONTACT

Selection Tables

Section 2

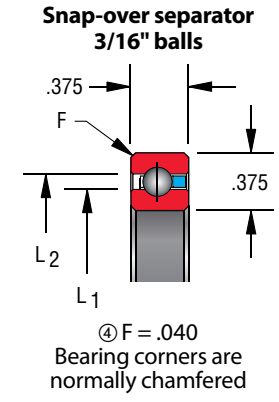
NC Series								
KAYDON Bearing Number	Dimensions in Inches				Capacities in Pounds ^①			Approx. Wt. in lbs.
	Size		Land Diameters		Dynamic		Static ^②	
	Bore	Outside Dia.	L ₁	L ₂	KAYDON Radial	ISO Radial ^③	Radial	
NC040CP0	3.9998	4.7503	4.277	4.473	1,073	2,321	2,100	.45
NC042CP0	4.2498	5.0003	4.527	4.723	1,108	2,370	2,220	.47
NC045CP0	4.4998	5.2503	4.777	4.973	1,143	2,418	2,340	.48
NC047CP0	4.7498	5.5003	5.027	5.223	1,176	2,464	2,460	.50
NC050CP0	4.9998	5.7503	5.277	5.473	1,209	2,509	2,590	.58
NC055CP0	5.4998	6.2503	5.777	5.973	1,274	2,594	2,830	.59
NC060CP0	5.9998	6.7503	6.277	6.473	1,337	2,674	3,070	.63
NC065CP0	6.4998	7.2503	6.777	6.973	1,397	2,751	3,310	.68
NC070CP0	6.9998	7.7503	7.277	7.473	1,457	2,823	3,550	.73
NC075CP0	7.4998	8.2503	7.777	7.973	1,514	2,893	3,790	.78
NC080CP0	7.9998	8.7503	8.277	8.473	1,570	2,960	4,030	.84
NC090CP0	8.9998	9.7503	9.277	9.473	1,678	3,085	4,510	.94
NC100CP0	9.9998	10.7503	10.277	10.473	1,781	3,203	4,990	1.06
NC110CP0	10.9998	11.7503	11.277	11.473	1,879	3,313	5,470	1.16
NC120CP0	11.9998	12.7503	12.277	12.473	1,974	3,417	5,950	1.25
NC140CP0	13.9998	14.7503	14.277	14.473	2,154	3,611	6,910	1.52
NC160CP0	15.9998	16.7503	16.277	16.473	2,321	3,787	7,880	1.73
NC180CP0	17.9998	18.7503	18.277	18.473	2,478	3,951	8,840	1.94
NC200CP0	19.9998	20.7503	20.277	20.473	2,626	4,104	9,800	2.16
NC250CP0	24.9998	25.7503	25.277	25.473	2,962	4,447	12,200	2.69
NC300CP0	29.9998	30.7503	30.277	30.473	3,260	4,750	14,610	3.21



ND Series								
KAYDON Bearing Number	Dimensions in Inches				Capacities in Pounds ^①			Approx. Wt. in lbs.
	Size		Land Diameters		Dynamic		Static ^②	
	Bore	Outside Dia.	L ₁	L ₂	KAYDON Radial	ISO Radial ^③	Radial	
ND040CP0	3.9998	5.0003	4.370	4.630	1,755	3,523	3,080	.78
ND042CP0	4.2498	5.2503	4.620	4.880	1,787	3,556	3,190	.83
ND045CP0	4.4998	5.5003	4.870	5.130	1,861	3,671	3,420	.88
ND047CP0	4.7498	5.7503	5.120	5.380	1,892	3,701	3,530	.94
ND050CP0	4.9998	6.0003	5.370	5.630	1,964	3,808	3,760	1.00
ND055CP0	5.4998	6.5003	5.870	6.130	2,063	3,937	4,100	1.06
ND060CP0	5.9998	7.0003	6.370	6.630	2,160	4,059	4,450	1.16
ND065CP0	6.4998	7.5003	6.870	7.130	2,254	4,174	4,790	1.22
ND070CP0	6.9998	8.0003	7.370	7.630	2,345	4,284	5,130	1.31
ND075CP0	7.4998	8.5003	7.870	8.130	2,434	4,388	5,470	1.41
ND080CP0	7.9998	9.0003	8.370	8.630	2,520	4,489	5,810	1.53
ND090CP0	8.9998	10.0003	9.370	9.630	2,688	4,678	6,500	1.72
ND100CP0	9.9998	11.0003	10.370	10.630	2,847	4,855	7,180	1.88
ND110CP0	10.9998	12.0003	11.370	11.630	3,000	5,021	7,870	2.06
ND120CP0	11.9998	13.0003	12.370	12.630	3,148	5,178	8,550	2.25
ND140CP0	13.9998	15.0003	14.370	14.630	3,427	5,469	9,920	2.73
ND160CP0	15.9998	17.0003	16.370	16.630	3,688	5,736	11,290	3.10
ND180CP0	17.9998	19.0003	18.370	18.630	3,933	5,982	12,650	3.48
ND200CP0	19.9998	21.0003	20.370	20.630	4,164	6,212	14,020	3.85
ND210CP0	20.9998	22.0003	21.370	21.630	4,274	6,321	14,706	4.04
ND250CP0	24.9998	26.0003	25.370	25.630	4,689	6,729	17,440	4.79
ND300CP0	29.9998	31.0003	30.370	30.360	5,153	7,186	20,860	5.73

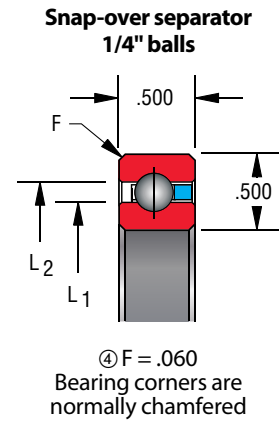

① Capacities listed are not simultaneous. For combined loading see discussion of [Bearing Selection](#) and [Load Analysis](#). Dynamic capacities are based upon 1 million revolutions of L10 life. Published capacities do not apply to hybrid series bearings P, X, and Y - contact Kaydon product engineering for values.

② Static capacities are non-brinell limits based on rigid support from the shaft and housing.

③ ISO Radial ratings are calculated per ISO 281:1990. They are included for comparison only (refer to [Page 95](#)).

④ "F" is the maximum shaft or housing fillet radius the bearing corners will clear.

Type C – Open Endurakote-Plated Endura-Slim Bearings, RADIAL CONTACT

NF Series								
KAYDON Bearing Number	Dimensions in Inches				Capacities in Pounds ^①			Approx. Wt. in lbs.
	Size		Land Diameters		Dynamic		Static ^②	
	Bore	Outside Dia.	L ₁	L ₂	KAYDON Radial	ISO Radial ^③	Radial	
NF040CPO	3.9998	5.5003	4.555	4.945	3,559	6,334	5,360	1.9
NF042CPO	4.2498	5.7503	4.805	5.195	3,655	6,472	5,640	2.0
NF045CPO	4.4998	6.0003	5.055	5.445	3,750	6,605	5,930	2.1
NF047CPO	4.7498	6.2503	5.305	5.695	3,843	6,732	6,210	2.2
NF050CPO	4.9998	6.5003	5.555	5.945	3,936	6,855	6,490	2.3
NF055CPO	5.4998	7.0003	6.055	6.445	4,116	7,089	7,050	2.5
NF060CPO	5.9998	7.5003	6.555	6.945	4,291	7,308	7,620	2.7
NF065CPO	6.4998	8.0003	7.055	7.445	4,461	7,516	8,180	2.9
NF070CPO	6.9998	8.5003	7.555	7.945	4,628	7,713	8,750	3.2
NF075CPO	7.4998	9.0003	8.055	8.445	4,791	7,901	9,310	3.4
NF080CPO	7.9998	9.5003	8.555	8.945	4,949	8,081	9,880	3.5
NF090CPO	8.9998	10.5003	9.555	9.945	5,256	8,421	11,000	3.9
NF100CPO	9.9998	11.5003	10.555	10.945	5,550	8,737	12,130	4.3
NF110CPO	10.9998	12.5003	11.555	11.945	5,833	9,033	13,260	4.8
NF120CPO	11.9998	13.5003	12.555	12.945	6,105	9,313	14,390	5.2
NF140CPO	13.9998	15.5003	14.555	14.945	6,620	9,832	16,650	6.0
NF160CPO	15.9998	17.5003	16.555	16.945	7,104	10,306	18,900	7.1
NF180CPO	17.9998	19.5003	18.555	18.945	7,557	10,744	21,160	7.9
NF200CPO	19.9998	21.5003	20.555	20.945	7,986	11,153	23,420	8.9
NF250CPO	24.9998	26.5003	25.555	25.945	8,963	12,074	29,060	10.9
NF300CPO	29.9998	31.5003	30.555	30.945	9,828	12,887	34,700	13.0
NF350CPO	34.9998	36.5003	35.555	35.945	10,603	13,620	40,350	15.1
NF400CPO	39.9998	41.5003	40.555	40.945	11,302	14,289	45,990	17.2

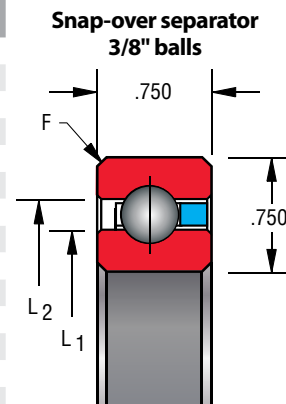

④ F = .080
Bearing corners are normally chamfered

NG Series								
KAYDON Bearing Number	Dimensions in Inches				Capacities in Pounds ^①			Approx. Wt. in lbs.
	Size		Land Diameters		Dynamic		Static ^②	
	Bore	Outside Dia.	L ₁	L ₂	KAYDON Radial	ISO Radial ^③	Radial	
NG040CPO	3.9998	6.0003	4.742	5.258	6,115	9,579	8,210	3.6
NG042CPO	4.2498	6.2503	4.992	5.508	6,061	9,481	8,210	3.8
NG045CPO	4.4998	6.5003	5.242	5.758	6,277	9,797	8,760	4.0
NG047CPO	4.7498	6.7503	5.492	6.008	6,487	10,009	9,300	4.1
NG050CPO	4.9998	7.0003	5.742	6.258	6,691	10,388	9,850	4.3
NG055CPO	5.4998	7.5003	6.242	6.758	6,850	10,563	10,400	4.7
NG060CPO	5.9998	8.0003	6.742	7.258	7,241	11,085	11,490	5.1
NG065CPO	6.4998	8.5003	7.242	7.758	7,393	11,234	12,040	5.4
NG070CPO	6.9998	9.0003	7.742	8.258	7,764	11,705	13,130	5.8
NG075CPO	7.4998	9.5003	8.242	8.758	7,911	11,835	13,680	6.1
NG080CPO	7.9998	10.0003	8.742	9.258	8,265	12,266	14,770	6.5
NG090CPO	8.9998	11.0003	9.742	10.258	8,743	12,782	16,420	7.2
NG100CPO	9.9998	12.0003	10.742	11.258	9,204	13,261	18,060	7.9
NG110CPO	10.9998	13.0003	11.742	12.258	9,648	13,710	19,700	8.6
NG120CPO	11.9998	14.0003	12.742	13.258	10,074	14,133	21,340	9.3
NG140CPO	13.9998	16.0003	14.742	15.258	10,886	14,916	24,620	10.8
NG160CPO	15.9998	18.0003	16.742	17.258	11,648	15,631	27,910	12.3
NG180CPO	17.9998	20.0003	18.742	19.258	12,367	16,291	31,190	13.7
NG200CPO	19.9998	22.0003	20.742	21.258	13,044	16,907	34,470	15.8
NG220CPO	21.9998	24.0003	22.742	23.258	13,685	17,486	37,757	16.8
NG250CPO	24.9998	27.0003	25.742	26.258	14,591	18,295	42,680	19.5
NG300CPO	29.9998	32.0003	30.742	31.258	15,963	19,519	50,890	23.3
NG350CPO	34.9998	37.0003	35.742	36.258	17,195	20,622	59,100	27.1
NG400CPO	39.9998	42.0003	40.742	41.258	18,307	21,630	67,310	30.8

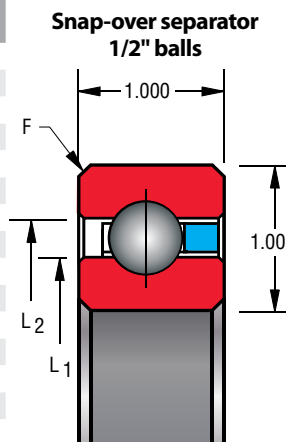

④ F = .080
Bearing corners are normally chamfered

① Capacities listed are not simultaneous. For combined loading see discussion of Bearing Selection and Load Analysis. Dynamic capacities are based upon 1 million revolutions of L10 life. Published capacities do not apply to hybrid series bearings P, X, and Y - contact Kaydon product engineering for values.
 ② Static capacities are non-brinell limits based on rigid support from the shaft and housing.
 ③ ISO Radial ratings are calculated per ISO 281:1990. They are included for comparison only (refer to Page 95).
 ④ "F" is the maximum shaft or housing fillet radius the bearing corners will clear.

Open Endurakote-Plated Endura-Slim Bearing Selections

Type X – FOUR-POINT CONTACT

A Conrad-assembled bearing designed for applications involving multiple loads. Unique internal geometry permits application of radial load, thrust load in either direction, and moment load,

individually or in any combination. A single four-point contact bearing may replace two bearings in many applications.

NAA Series											
KAYDON Bearing Number	Dimensions in Inches				Capacities ^①						Approx. Wt. in lbs.
	Size		Land Diameters		Dynamic			Static ^②			
	Bore	Outside Dia.	L ₁	L ₂	Radial (lbs)	Thrust (lbs)	Moment (in-lbs)	Radial (lbs)	Thrust (lbs)	Moment (in-lbs)	
NAA10XL0	1.0000	1.3752	1.140	1.235	247	370	110	290	730	170	.026
NAA15XL0	1.5000	1.8752	1.640	1.735	296	460	187	400	1,000	340	.039
NAA17XL0	1.7500	2.1252	1.890	1.985	319	500	232	460	1,140	440	.045

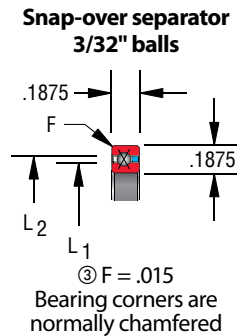

NA Series											
KAYDON Bearing Number	Dimensions in Inches				Capacities ^①						Approx. Wt. in lbs.
	Size		Land Diameters		Dynamic			Static ^②			
	Bore	Outside Dia.	L ₁	L ₂	Radial (lbs)	Thrust (lbs)	Moment (in-lbs)	Radial (lbs)	Thrust (lbs)	Moment (in-lbs)	
NA020XP0	2.0000	2.5002	2.186	2.314	514	790	434	680	1,710	770	.10
NA025XP0	2.5000	3.0002	2.686	2.814	583	910	601	830	2,090	1,150	.13
NA030XP0	3.0000	3.5002	3.186	3.314	643	1,010	785	990	2,470	1,600	.15
NA035XP0	3.5000	4.0002	3.686	3.814	701	1,110	986	1,140	2,850	2,130	.18
NA040XP0	3.9998	4.5003	4.186	4.314	756	1,210	1,205	1,290	3,220	2,740	.19
NA042XP0	4.2498	4.7503	4.436	4.564	783	1,260	1,321	1,370	3,410	3,070	.20
NA045XP0	4.4998	5.0003	4.686	4.814	809	1,310	1,441	1,440	3,600	3,420	.22
NA047XP0	4.7498	5.2503	4.936	5.064	834	1,350	1,565	1,520	3,790	3,790	.23
NA050XP0	4.9998	5.5003	5.186	5.314	859	1,400	1,693	1,590	3,980	4,180	.24
NA055XP0	5.4998	6.0003	5.686	5.814	908	1,480	1,959	1,750	4,360	5,020	.25
NA060XP0	5.9998	6.5003	6.186	6.314	955	1,570	2,240	1,900	4,740	5,930	.28
NA065XP0	6.4998	7.0003	6.686	6.814	1,001	1,650	2,535	2,050	5,120	6,910	.30
NA070XP0	6.9998	7.5003	7.186	7.314	1,046	1,730	2,844	2,200	5,500	7,980	.31
NA075XP0	7.4998	8.0003	7.686	7.814	1,089	1,810	3,165	2,350	5,880	9,120	.34
NA080XP0	7.9998	8.5003	8.186	8.314	1,131	1,890	3,499	2,500	6,260	10,330	.38
NA090XP0	8.9998	9.5003	9.186	9.314	1,212	2,040	4,204	2,810	7,020	12,990	.44
NA100XP0	9.9998	10.5003	10.186	10.314	1,289	2,180	4,956	3,110	7,780	15,940	.50
NA110XP0	10.9998	11.5003	11.186	11.314	1,362	2,320	5,750	3,410	8,540	19,210	.52
NA120XP0	11.9998	12.5003	12.186	12.314	1,433	2,450	6,587	3,720	9,300	22,770	.56

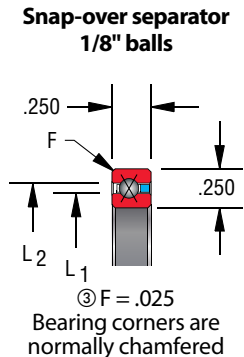

① Capacities listed are not simultaneous. For combined loading see discussion of [Bearing Selection](#) and [Load Analysis](#). Dynamic capacities are based upon 1 million revolutions of L10 life. Published capacities do not apply to hybrid series bearings P, X, and Y - contact Kaydon product engineering for values.

② Static capacities are non-brinell limits based on rigid support from the shaft and housing.

③ "F" is the maximum shaft or housing fillet radius the bearing corners will clear.

Type X – Open Endurakote-Plated Endura-Slim Bearings, FOUR-POINT CONTACT

NB Series											
KAYDON Bearing Number	Dimensions in Inches				Capacities ^①						Approx. Wt. in lbs.
	Size		Land Diameters		Dynamic			Static ^②			
	Bore	Outside Dia.	L ₁	L ₂	Radial (lbs)	Thrust (lbs)	Moment (in-lbs)	Radial (lbs)	Thrust (lbs)	Moment (in-lbs)	
NB020XP0	2.0000	2.6252	2.231	2.393	758	1,130	658	930	2,340	1,080	.16
NB025XP0	2.5000	3.1252	2.731	2.893	848	1,290	895	1,140	2,840	1,600	.19
NB030XP0	3.0000	3.6252	3.231	3.393	933	1,440	1,159	1,340	3,350	2,220	.24
NB035XP0	3.5000	4.1252	3.731	3.893	1,014	1,590	1,450	1,540	3,860	2,940	.27
NB040XP0	3.9998	4.6253	4.231	4.393	1,091	1,720	1,764	1,750	4,370	3,770	.30
NB042XP0	4.2498	4.8753	4.481	4.643	1,120	1,780	1,917	1,830	4,570	4,170	.31
NB045XP0	4.4998	5.1253	4.731	4.893	1,165	1,850	2,103	1,950	4,880	4,690	.33
NB047XP0	4.7498	5.3753	4.981	5.143	1,193	1,900	2,265	2,030	5,080	5,140	.34
NB050XP0	4.9998	5.6253	5.231	5.393	1,236	1,980	2,463	2,150	5,380	5,720	.38
NB055XP0	5.4998	6.1253	5.731	5.893	1,304	2,100	2,844	2,360	5,890	6,850	.41
NB060XP0	5.9998	6.6253	6.231	6.393	1,371	2,220	3,247	2,560	6,400	8,080	.44
NB065XP0	6.4998	7.1253	6.731	6.893	1,435	2,340	3,668	2,760	6,910	9,410	.47
NB070XP0	6.9998	7.6253	7.231	7.393	1,498	2,450	4,109	2,970	7,420	10,850	.50
NB075XP0	7.4998	8.1253	7.731	7.893	1,559	2,560	4,568	3,170	7,920	12,380	.53
NB080XP0	7.9998	8.6253	8.231	8.393	1,618	2,670	5,045	3,370	8,430	14,020	.57
NB090XP0	8.9998	9.6253	9.231	9.393	1,732	2,880	6,050	3,780	9,450	17,600	.66
NB100XP0	9.9998	10.6253	10.231	10.393	1,841	3,080	7,121	4,190	10,460	21,580	.73
NB110XP0	10.9998	11.6253	11.231	11.393	1,945	3,280	8,254	4,590	11,480	25,970	.75
NB120XP0	11.9998	12.6253	12.231	12.393	2,045	3,470	9,446	5,000	12,500	30,770	.83
NB140XP0	13.9998	14.6253	14.231	14.393	2,234	3,840	11,994	5,810	14,530	41,580	1.05
NB160XP0	15.9998	16.6253	16.231	16.393	2,410	4,190	14,750	6,620	16,560	54,020	1.20
NB180XP0	17.9998	18.6253	18.231	18.393	2,576	4,520	17,694	7,440	18,590	68,090	1.35
NB200XP0	19.9998	20.6253	20.231	20.393	2,731	4,850	20,813	8,250	20,620	83,780	1.50

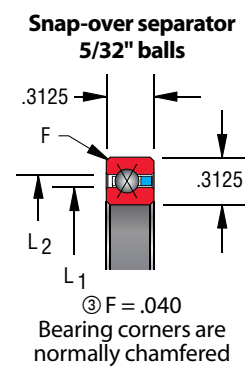

① Capacities listed are not simultaneous. For combined loading see discussion of Bearing Selection and Load Analysis. Dynamic capacities are based upon 1 million revolutions of L10 life. Published capacities do not apply to hybrid series bearings P, X, and Y - contact Kaydon product engineering for values.
 ② Static capacities are non-brinell limits based on rigid support from the shaft and housing.
 ③ "F" is the maximum shaft or housing fillet radius the bearing corners will clear.

CONTACT Kaydon at —
Kaydon Bearings • Muskegon, Michigan 49443
Telephone: 231-755-3741 • Fax: 231-759-4102

Need Service Fast?
1-800-514-3066
www.kaydonbearings.com





Type X – Open Endurakote-Plated Endura-Slim Bearings, FOUR-POINT CONTACT

Selection Tables
Section 2

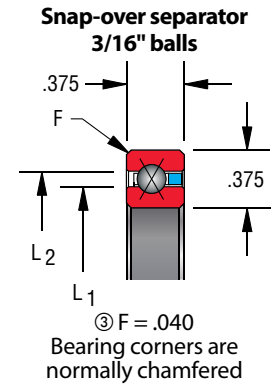
NC Series											
KAYDON Bearing Number	Dimensions in Inches				Capacities ^①						Approx. Wt. in lbs.
	Size		Land Diameters		Dynamic			Static ^②			
	Bore	Outside Dia.	L ₁	L ₂	Radial (lbs)	Thrust (lbs)	Moment (in-lbs)	Radial (lbs)	Thrust (lbs)	Moment (in-lbs)	
NC040XP0	3.9998	4.7503	4.277	4.473	1,417	2,210	2,326	2,100	5,260	4,600	.45
NC042XP0	4.2498	5.0003	4.527	4.723	1,464	2,290	2,541	2,220	5,560	5,140	.47
NC045XP0	4.4998	5.2503	4.777	4.973	1,510	2,380	2,762	2,340	5,860	5,710	.48
NC047XP0	4.7498	5.5003	5.027	5.223	1,556	2,460	2,991	2,460	6,160	6,320	.50
NC050XP0	4.9998	5.7503	5.277	5.473	1,600	2,540	3,226	2,590	6,460	6,950	.58
NC055XP0	5.4998	6.2503	5.777	5.973	1,687	2,690	3,717	2,830	7,060	8,300	.59
NC060XP0	5.9998	6.7503	6.277	6.473	1,770	2,840	4,234	3,070	7,660	9,770	.63
NC065XP0	6.4998	7.2503	6.777	6.973	1,851	2,990	4,775	3,310	8,270	11,370	.68
NC070XP0	6.9998	7.7503	7.277	7.473	1,931	3,130	5,341	3,550	8,870	13,080	.73
NC075XP0	7.4998	8.2503	7.777	7.973	2,007	3,270	5,930	3,790	9,470	14,910	.78
NC080XP0	7.9998	8.7503	8.277	8.473	2,082	3,410	6,542	4,030	10,070	16,870	.84
NC090XP0	8.9998	9.7503	9.277	9.473	2,226	3,670	7,830	4,510	11,270	21,130	.94
NC100XP0	9.9998	10.7503	10.277	10.473	2,364	3,930	9,201	4,990	12,470	25,880	1.06
NC110XP0	10.9998	11.7503	11.277	11.473	2,496	4,180	10,651	5,470	13,680	31,110	1.16
NC120XP0	11.9998	12.7503	12.277	12.473	2,622	4,420	12,174	5,950	14,880	36,830	1.25
NC140XP0	13.9998	14.7503	14.277	14.473	2,862	4,890	15,434	6,910	17,280	49,690	1.52
NC160XP0	15.9998	16.7503	16.277	16.473	3,086	5,330	18,955	7,880	19,690	64,480	1.73
NC180XP0	17.9998	18.7503	18.277	18.473	3,295	5,760	22,712	8,840	22,090	81,190	1.94
NC200XP0	19.9998	20.7503	20.277	20.473	3,492	6,170	26,695	9,800	24,500	99,830	2.16
NC250XP0	24.9998	25.7503	25.277	25.473	3,941	7,140	37,518	12,200	30,510	154,800	2.69
NC300XP0	29.9998	30.7503	30.277	30.473	4,338	8,050	49,436	14,610	36,520	221,900	3.21

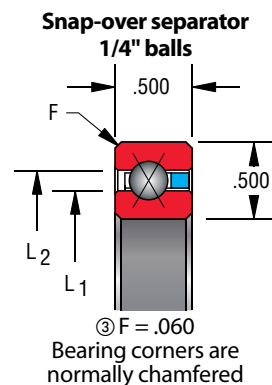

ND Series											
KAYDON Bearing Number	Dimensions in Inches				Capacities ^①						Approx. Wt. in lbs.
	Size		Land Diameters		Dynamic			Static ^②			
	Bore	Outside Dia.	L ₁	L ₂	Radial (lbs)	Thrust (lbs)	Moment (in-lbs)	Radial (lbs)	Thrust (lbs)	Moment (in-lbs)	
ND040XP0	3.9998	5.0003	4.370	4.630	2,311	3,520	3,901	3,080	7,700	6,930	.78
ND042XP0	4.2498	5.2503	4.620	4.880	2,355	3,600	4,196	3,190	7,980	7,580	.83
ND045XP0	4.4998	5.5003	4.870	5.130	2,454	3,770	4,602	3,420	8,550	8,550	.88
ND047XP0	4.7498	5.7503	5.120	5.380	2,496	3,860	4,916	3,530	8,840	9,280	.94
ND050XP0	4.9998	6.0003	5.370	5.630	2,592	4,020	5,348	3,760	9,410	10,350	1.00
ND055XP0	5.4998	6.5003	5.870	6.130	2,725	4,260	6,134	4,100	10,260	12,310	1.06
ND060XP0	5.9998	7.0003	6.370	6.630	2,855	4,490	6,961	4,450	11,120	14,450	1.16
ND065XP0	6.4998	7.5003	6.870	7.130	2,980	4,720	7,826	4,790	11,970	16,760	1.22
ND070XP0	6.9998	8.0003	7.370	7.630	3,103	4,940	8,730	5,130	12,830	19,240	1.31
ND075XP0	7.4998	8.5003	7.870	8.130	3,222	5,160	9,669	5,470	13,680	21,890	1.41
ND080XP0	7.9998	9.0003	8.370	8.630	3,338	5,370	10,643	5,810	14,540	24,710	1.53
ND090XP0	8.9998	10.0003	9.370	9.630	3,561	5,790	12,693	6,500	16,250	30,870	1.72
ND100XP0	9.9998	11.0003	10.370	10.630	3,776	6,190	14,872	7,180	17,960	37,710	1.88
ND110XP0	10.9998	12.0003	11.370	11.630	3,981	6,570	17,173	7,870	19,670	45,230	2.06
ND120XP0	11.9998	13.0003	12.370	12.630	4,178	6,950	19,590	8,550	21,380	53,440	2.25
ND140XP0	13.9998	15.0003	14.370	14.630	4,551	7,670	24,755	9,920	24,800	71,910	2.73
ND160XP0	15.9998	17.0003	16.370	16.630	4,899	8,360	30,325	11,290	28,220	93,110	3.10
ND180XP0	17.9998	19.0003	18.370	18.630	5,226	9,030	36,268	12,650	31,640	117,000	3.48
ND200XP0	19.9998	21.0003	20.370	20.630	5,534	9,670	42,561	14,020	35,060	143,700	3.85
ND210XP0	20.9998	22.0003	21.370	21.630	5,682	9,980	45,826	14,710	36,770	158,100	4.04
ND250XP0	24.9998	26.0003	25.370	25.630	6,235	11,180	59,649	17,440	43,610	222,400	4.79
ND300XP0	29.9998	31.0003	30.370	30.630	6,856	12,600	78,447	20,860	52,160	318,100	5.73



① Capacities listed are not simultaneous. For combined loading see discussion of Bearing Selection and Load Analysis. Dynamic capacities are based upon 1 million revolutions of L10 life. Published capacities do not apply to hybrid series bearings P, X, and Y - contact Kaydon product engineering for values.

② Static capacities are non-brinell limits based on rigid support from the shaft and housing.

③ "F" is the maximum shaft or housing fillet radius the bearing corners will clear.

Type X – Open Endurakote-Plated Endura-Slim Bearings, FOUR-POINT CONTACT

NF Series											
KAYDON Bearing Number	Dimensions in Inches				Capacities ^①						Approx. Wt. in lbs.
	Size		Land Diameters		Dynamic			Static ^②			
	Bore	Outside Dia.	L ₁	L ₂	Radial (lbs)	Thrust (lbs)	Moment (in-lbs)	Radial (lbs)	Thrust (lbs)	Moment (in-lbs)	
NF040XP0	3.9998	5.5003	4.555	4.945	4,665	6,830	8,312	5,360	13,400	12,730	1.9
NF042XP0	4.2498	5.7503	4.805	5.195	4,795	7,070	8,993	5,640	14,110	14,110	2.0
NF045XP0	4.4998	6.0003	5.055	5.445	4,923	7,300	9,695	5,930	14,810	15,550	2.1
NF047XP0	4.7498	6.2503	5.305	5.695	5,048	7,530	10,416	6,210	15,520	17,070	2.2
NF050XP0	4.9998	6.5003	5.555	5.945	5,172	7,760	11,157	6,490	16,220	18,660	2.3
NF055XP0	5.4998	7.0003	6.055	6.445	5,415	8,200	12,696	7,050	17,630	22,040	2.5
NF060XP0	5.9998	7.5003	6.555	6.945	5,651	8,630	14,311	7,620	19,050	25,710	2.7
NF065XP0	6.4998	8.0003	7.055	7.445	5,880	9,050	15,993	8,180	20,460	29,660	2.9
NF070XP0	6.9998	8.5003	7.555	7.945	6,103	9,460	17,744	8,750	21,870	33,890	3.2
NF075XP0	7.4998	9.0003	8.055	8.445	6,323	9,870	19,568	9,310	23,280	38,410	3.4
NF080XP0	7.9998	9.5003	8.555	8.945	6,535	10,260	21,453	9,880	24,690	43,200	3.5
NF090XP0	8.9998	10.5003	9.555	9.945	6,947	11,030	25,410	11,000	27,510	53,640	3.9
NF100XP0	9.9998	11.5003	10.555	10.945	7,342	11,770	29,608	12,130	30,330	65,210	4.3
NF110XP0	10.9998	12.5003	11.555	11.945	7,721	12,490	34,032	13,260	33,150	77,910	4.8
NF120XP0	11.9998	13.5003	12.555	12.945	8,084	13,190	38,666	14,390	35,970	91,730	5.2
NF140XP0	13.9998	15.5003	14.555	14.945	8,775	14,530	48,556	16,650	41,620	122,800	6.0
NF160XP0	15.9998	17.5003	16.555	16.945	9,421	15,820	59,200	18,900	47,260	158,300	7.1
NF180XP0	17.9998	19.5003	18.555	18.945	10,028	17,060	70,537	21,160	52,900	198,400	7.9
NF200XP0	19.9998	21.5003	20.555	20.945	10,602	18,250	82,528	23,420	58,550	243,000	8.9
NF250XP0	24.9998	26.5003	25.555	25.945	11,909	21,070	115,037	29,060	72,650	374,200	10.9
NF300XP0	29.9998	31.5003	30.555	30.945	13,065	23,720	150,708	34,700	86,760	533,600	13.0
NF350XP0	34.9998	36.5003	35.555	35.945	14,100	26,220	189,106	40,350	100,900	721,200	15.1
NF400XP0	39.9998	41.5003	40.555	40.945	15,034	28,620	229,832	45,990	115,000	937,100	17.2

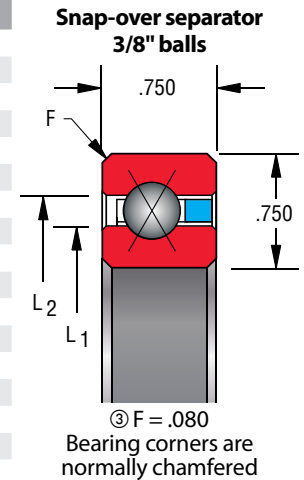

NG Series											
KAYDON Bearing Number	Dimensions in Inches				Capacities ^①						Approx. Wt. in lbs.
	Size		Land Diameters		Dynamic			Static ^②			
	Bore	Outside Dia.	L ₁	L ₂	Radial (lbs)	Thrust (lbs)	Moment (in-lbs)	Radial (lbs)	Thrust (lbs)	Moment (in-lbs)	
NG040XP0	3.9998	6.0003	4.742	5.258	7,979	11,260	14,966	8,210	20,520	20,520	3.6
NG042XP0	4.2498	6.2503	4.992	5.508	7,917	11,260	15,592	8,210	20,520	21,550	3.8
NG045XP0	4.4998	6.5003	5.242	5.758	8,205	11,750	16,930	8,760	21,890	24,080	4.0
NG047XP0	4.7498	6.7503	5.492	6.008	8,487	12,230	18,306	9,300	23,260	26,740	4.1
NG050XP0	4.9998	7.0003	5.742	6.258	8,762	12,710	19,721	9,850	24,620	29,550	4.3
NG055XP0	5.4998	7.5003	6.242	6.758	8,979	13,180	21,896	10,400	25,990	33,790	4.7
NG060XP0	5.9998	8.0003	6.742	7.258	9,503	14,090	24,956	11,490	28,730	40,220	5.1
NG065XP0	6.4998	8.5003	7.242	7.758	9,713	14,530	27,327	12,040	30,100	45,140	5.4
NG070XP0	6.9998	9.0003	7.742	8.258	10,208	15,400	30,636	13,130	32,830	52,530	5.8
NG075XP0	7.4998	9.5003	8.242	8.758	10,410	15,820	33,196	13,680	34,200	58,140	6.1
NG080XP0	7.9998	10.0003	8.742	9.258	10,882	16,650	36,743	14,770	36,940	66,480	6.5
NG090XP0	8.9998	11.0003	9.742	10.258	11,526	17,870	43,240	16,420	41,040	82,080	7.2
NG100XP0	9.9998	12.0003	10.742	11.258	12,147	19,040	50,124	18,060	45,140	99,320	7.9
NG110XP0	10.9998	13.0003	11.742	12.258	12,739	20,180	57,347	19,700	49,250	118,200	8.6
NG120XP0	11.9998	14.0003	12.742	13.258	13,315	21,280	64,935	21,340	53,350	138,700	9.3
NG140XP0	13.9998	16.0003	14.742	15.258	14,404	23,410	81,056	24,620	61,560	184,700	10.8
NG160XP0	15.9998	18.0003	16.742	17.258	15,425	25,450	98,373	27,910	69,770	237,200	12.3
NG180XP0	17.9998	20.0003	18.742	19.258	16,386	27,410	116,793	31,190	77,980	296,300	13.7
NG200XP0	19.9998	22.0003	20.742	21.258	17,293	29,300	136,238	34,470	86,180	362,000	15.8
NG220XP0	21.9998	24.0003	22.742	23.258	18,152	31,130	156,625	37,760	94,390	434,200	17.3
NG250XP0	24.9998	27.0003	25.742	26.258	19,360	33,780	188,838	42,680	106,700	554,900	19.5
NG300XP0	29.9998	32.0003	30.742	31.258	21,200	37,980	246,541	50,890	127,200	788,800	23.3
NG350XP0	34.9998	37.0003	35.742	36.258	22,845	41,970	308,527	59,100	147,700	1,064,000	27.1
NG400XP0	39.9998	42.0003	40.742	41.258	24,332	45,770	374,256	67,310	168,300	1,380,000	30.8

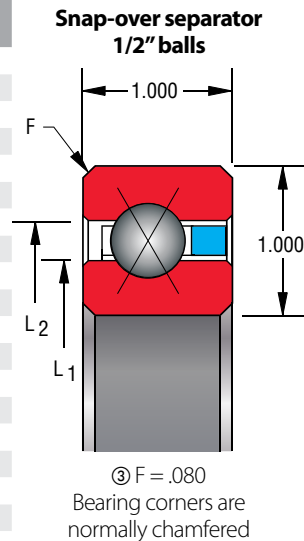

① Capacities listed are not simultaneous. For combined loading see discussion of Bearing Selection and Load Analysis. Dynamic capacities are based upon 1 million revolutions of L10 life. Published capacities do not apply to hybrid series bearings P, X, and Y - contact Kaydon product engineering for values.

② Static capacities are non-brinell limits based on rigid support from the shaft and housing.

③ "F" is the maximum shaft or housing fillet radius the bearing corners will clear.

Precision Tolerances and Recommended Fits for Real-Slim Ball Bearings in Normal Applications

Section 2 Selection Tables

Type C with Endurakote Plating – Precision Class 1												
Bearing Size (Inch Series)	Bearing Diameters		Radial & Axial Runout		Rotating Shaft or Duplex DF Mounting		Stationary Shaft or Duplex DB Mounting			Bearing Diametral Clearance* (Type "X" and "C" only) Before Installation		
	Bearing Bore Nominal +.0000	Bearing O.D. Nominal +.0000	Inner Race	Outer Race	Shaft Diameter Nominal -.0000	Housing Bore Nominal -.0000	Shaft Diameter Nominal	Housing Bore Nominal				
010	-.0006	-.0007	.0005	.0008	+.0006	+.0007	-.0006	-.0012	-.0007	-.0014	.0010	.0016
015	-.0007	-.0007	.0006	.0008	+.0007	+.0007	-.0007	-.0014	-.0007	-.0014	.0012	.0018
017	-.0008	-.0007	.0008	.0010	+.0008	+.0007	-.0008	-.0016	-.0007	-.0014	.0012	.0024
020	-.0008	-.0007	.0008	.0010	+.0008	+.0007	-.0008	-.0016	-.0007	-.0014	.0012	.0024
025	-.0008	-.0007	.0008	.0010	+.0008	+.0007	-.0008	-.0016	-.0007	-.0014	.0012	.0024
030	-.0008	-.0008	.0008	.0010	+.0008	+.0008	-.0008	-.0016	-.0008	-.0016	.0012	.0024
035	-.0010	-.0008	.0010	.0012	+.0010	+.0008	-.0010	-.0020	-.0008	-.0016	.0016	.0028
040	-.0009	-.0007	.0010	.0012	+.0009	+.0007	-.0009	-.0018	-.0007	-.0014	.0016	.0028
042	-.0009	-.0009	.0010	.0014	+.0009	+.0009	-.0009	-.0018	-.0009	-.0018	.0016	.0028
045	-.0009	-.0009	.0010	.0014	+.0009	+.0009	-.0009	-.0018	-.0009	-.0018	.0016	.0028
047	-.0011	-.0009	.0012	.0014	+.0011	+.0009	-.0011	-.0022	-.0009	-.0018	.0020	.0034
050	-.0011	-.0009	.0012	.0014	+.0011	+.0009	-.0011	-.0022	-.0009	-.0018	.0020	.0034
055	-.0011	-.0011	.0012	.0016	+.0011	+.0011	-.0011	-.0022	-.0011	-.0022	.0020	.0034
060	-.0011	-.0011	.0012	.0016	+.0011	+.0011	-.0011	-.0022	-.0011	-.0022	.0020	.0034
065	-.0011	-.0011	.0012	.0016	+.0011	+.0011	-.0011	-.0022	-.0011	-.0022	.0020	.0034
070	-.0011	-.0013	.0012	.0016	+.0011	+.0013	-.0011	-.0022	-.0013	-.0026	.0024	.0042
075	-.0013	-.0013	.0016	.0018	+.0013	+.0013	-.0013	-.0026	-.0013	-.0026	.0024	.0042
080	-.0013	-.0013	.0016	.0018	+.0013	+.0013	-.0013	-.0026	-.0013	-.0026	.0024	.0042
090	-.0013	-.0013	.0016	.0018	+.0013	+.0013	-.0013	-.0026	-.0013	-.0026	.0024	.0042
100	-.0015	-.0015	.0018	.0020	+.0015	+.0015	-.0015	-.0030	-.0015	-.0030	.0028	.0048
110	-.0015	-.0015	.0018	.0020	+.0015	+.0015	-.0015	-.0030	-.0015	-.0030	.0028	.0048
120	-.0015	-.0015	.0018	.0020	+.0015	+.0015	-.0015	-.0030	-.0015	-.0030	.0028	.0048
140	-.0017	-.0017	.0018	.0020	+.0017	+.0017	-.0017	-.0034	-.0017	-.0034	.0032	.0052
160	-.0019	-.0019	.0018	.0020	+.0019	+.0019	-.0019	-.0038	-.0019	-.0038	.0036	.0056
180	-.0019	-.0019	.0020	.0020	+.0019	+.0019	-.0019	-.0038	-.0019	-.0038	.0036	.0056
200	-.0021	-.0021	.0020	.0020	+.0021	+.0021	-.0021	-.0042	-.0021	-.0042	.0040	.0060
210	-.0021	-.0021	.0020	.0020	+.0021	+.0021	-.0021	-.0042	-.0021	-.0042	.0040	.0060
220	-.0021	-.0021	.0020	.0020	+.0021	+.0021	-.0021	-.0042	-.0021	-.0042	.0040	.0060
250	-.0031	-.0031	.0020	.0020	+.0031	+.0031	-.0031	-.0062	-.0031	-.0062	.0060	.0080
300	-.0031	-.0031	.0020	.0020	+.0031	+.0031	-.0031	-.0062	-.0031	-.0062	.0060	.0080
350	-.0041	-.0041	.0020	.0020	+.0041	+.0041	-.0041	-.0082	-.0041	-.0082	.0080	.0100
400	-.0041	-.0041	.0020	.0020	+.0041	+.0041	-.0041	-.0082	-.0041	-.0082	.0080	.0100

* Diametral clearance after installation theoretically can range rather widely if all contributing bearing, housing, and shaft tolerances are at either of their extremes. Diametral clearances shown do not apply to Type A (angular contact) bearings.

Listed shaft and housing diameters are for steel supports with standard bearing diametral clearance. Recommended shaft and housing diameters can change greatly based on orientation, temperature, speed, non-standard diametral clearances, and desired performance characteristics. Contact Kaydon for design assistance when required.

Total Width Tolerance—Duplexed Type A Bearings:

Up thru 12" Bearing Bore +.000 –.010
Over 12" Bearing Bore +.000 –.020

Race Width Tolerance—Single Type C, X, A Bearings:

Up thru 12" Bearing Bore +.000 –.005
Over 12" Bearing Bore +.000 –.010

All dimensions in inches.

Precision Tolerances and Recommended Fits for Reali-Slim Bearings (continued)

Type X and A with Endurakote Plating – Precision Class 1												
Bearing Size (Inch Series)	Bearing Diameters		Radial & Axial Runout		Rotating Shaft or Duplex DF Mounting		Stationary Shaft or Duplex DB Mounting			Bearing Diametral Clearance* (Type "X" and "C" only) Before Installation		
	Bearing Bore Nominal +.0000	Bearing O.D. Nominal +.0000	Inner Race	Outer Race	Shaft Diameter Nominal -.0000	Housing Bore Nominal -.0000	Shaft Diameter Nominal	Housing Bore Nominal				
010	-.0006	-.0007	.0003	.0004	+.0006	+.0007	-.0006	-.0012	-.0007	-.0014	.0010	.0015
015	-.0007	-.0007	.0004	.0004	+.0007	+.0007	-.0007	-.0014	-.0007	-.0014	.0012	.0017
017	-.0008	-.0007	.0005	.0005	+.0008	+.0007	-.0008	-.0016	-.0007	-.0014	.0012	.0022
020	-.0008	-.0007	.0005	.0005	+.0008	+.0007	-.0008	-.0016	-.0007	-.0014	.0012	.0022
025	-.0008	-.0007	.0005	.0005	+.0008	+.0007	-.0008	-.0016	-.0007	-.0014	.0012	.0022
030	-.0008	-.0008	.0006	.0006	+.0008	+.0008	-.0008	-.0016	-.0008	-.0016	.0012	.0022
035	-.0010	-.0008	.0006	.0006	+.0010	+.0008	-.0010	-.0020	-.0008	-.0016	.0016	.0026
040	-.0009	-.0007	.0006	.0006	+.0009	+.0007	-.0009	-.0018	-.0007	-.0014	.0016	.0026
042	-.0009	-.0009	.0008	.0008	+.0009	+.0009	-.0009	-.0018	-.0009	-.0018	.0016	.0026
045	-.0009	-.0009	.0008	.0008	+.0009	+.0009	-.0009	-.0018	-.0009	-.0018	.0016	.0026
047	-.0011	-.0009	.0008	.0008	+.0011	+.0009	-.0011	-.0022	-.0009	-.0018	.0020	.0030
050	-.0011	-.0009	.0008	.0008	+.0011	+.0009	-.0011	-.0022	-.0009	-.0018	.0020	.0030
055	-.0011	-.0011	.0010	.0010	+.0011	+.0011	-.0011	-.0022	-.0011	-.0022	.0020	.0030
060	-.0011	-.0011	.0010	.0010	+.0011	+.0011	-.0011	-.0022	-.0011	-.0022	.0020	.0030
065	-.0011	-.0011	.0010	.0010	+.0011	+.0011	-.0011	-.0022	-.0011	-.0022	.0020	.0030
070	-.0011	-.0013	.0010	.0010	+.0011	+.0013	-.0011	-.0022	-.0013	-.0026	.0024	.0034
075	-.0013	-.0013	.0012	.0012	+.0013	+.0013	-.0013	-.0026	-.0013	-.0026	.0024	.0034
080	-.0013	-.0013	.0012	.0012	+.0013	+.0013	-.0013	-.0026	-.0013	-.0026	.0024	.0034
090	-.0013	-.0013	.0012	.0012	+.0013	+.0013	-.0013	-.0026	-.0013	-.0026	.0024	.0034
100	-.0015	-.0015	.0014	.0014	+.0015	+.0015	-.0015	-.0030	-.0015	-.0030	.0028	.0038
110	-.0015	-.0015	.0014	.0014	+.0015	+.0015	-.0015	-.0030	-.0015	-.0030	.0028	.0038
120	-.0015	-.0015	.0014	.0014	+.0015	+.0015	-.0015	-.0030	-.0015	-.0030	.0028	.0038
140	-.0015	-.0015	.0014	.0014	+.0015	+.0015	-.0015	-.0030	-.0015	-.0030	.0028	.0038
160	-.0017	-.0017	.0016	.0016	+.0017	+.0017	-.0017	-.0034	-.0017	-.0034	.0032	.0042
180	-.0017	-.0017	.0016	.0016	+.0017	+.0017	-.0017	-.0034	-.0017	-.0034	.0032	.0042
200	-.0019	-.0019	.0018	.0018	+.0019	+.0019	-.0019	-.0038	-.0019	-.0038	.0036	.0046
210	-.0019	-.0019	.0018	.0018	+.0019	+.0019	-.0019	-.0038	-.0019	-.0038	.0036	.0046
220	-.0019	-.0019	.0018	.0018	+.0019	+.0019	-.0019	-.0038	-.0019	-.0038	.0036	.0046
250	-.0019	-.0019	.0018	.0018	+.0019	+.0019	-.0019	-.0038	-.0019	-.0038	.0036	.0046
300	-.0019	-.0019	.0018	.0018	+.0019	+.0019	-.0019	-.0038	-.0019	-.0038	.0036	.0046
350	-.0021	-.0021	.0020	.0020	+.0021	+.0021	-.0021	-.0042	-.0021	-.0042	.0040	.0050
400	-.0021	-.0021	.0020	.0020	+.0021	+.0021	-.0021	-.0042	-.0021	-.0042	.0040	.0050

* Diametral clearance after installation theoretically can range rather widely if all contributing bearing, housing, and shaft tolerances are at either of their extremes. Diametral clearances shown do not apply to Type A (angular contact) bearings.

Listed shaft and housing diameters are for steel supports with standard bearing diametral clearance. Recommended shaft and housing diameters can change greatly based on orientation, temperature, speed, non-standard diametral clearances, and desired performance characteristics. Contact Kaydon for design assistance when required.

Total Width Tolerance—Duplexed Type A Bearings:
 Up thru 12" Bearing Bore +.000 –.010
 Over 12" Bearing Bore +.000 –.020
 Race Width Tolerance—Single Type C, X, A Bearings:
 Up thru 12" Bearing Bore +.000 –.005
 Over 12" Bearing Bore +.000 –.010

All dimensions in inches.

Precision Tolerances and Recommended Fits for Reali-Slim Bearings (continued)

Type C, X, and A with Endurakote Plating – Precision Class 3												
Bearing Size (Inch Series)	Bearing Diameters		Radial & Axial Runout		Rotating Shaft or Duplex DF Mounting		Stationary Shaft or Duplex DB Mounting			Bearing Diametral Clearance* (Type "X" and "C" only) Before Installation		
	Bearing Bore Nominal +.0000	Bearing O.D. Nominal +.0000	Inner Race	Outer Race	Shaft Diameter Nominal -.0000	Housing Bore Nominal -.0000	Shaft Diameter Nominal	Housing Bore Nominal				
010	-.0004	-.0005	.0003	.0004	+.0004	+.0005	-.0004	-.0008	-.0005	-.0010	.0007	.0011
015	-.0005	-.0005	.0004	.0004	+.0005	+.0005	-.0005	-.0010	-.0005	-.0010	.0008	.0012
017	-.0006	-.0006	.0004	.0005	+.0006	+.0006	-.0006	-.0012	-.0006	-.0012	.0008	.0018
020	-.0006	-.0006	.0004	.0005	+.0006	+.0006	-.0006	-.0012	-.0006	-.0012	.0008	.0018
025	-.0006	-.0006	.0004	.0005	+.0006	+.0006	-.0006	-.0012	-.0006	-.0012	.0008	.0018
030	-.0006	-.0006	.0004	.0006	+.0006	+.0006	-.0006	-.0012	-.0006	-.0012	.0008	.0018
035	-.0007	-.0006	.0005	.0006	+.0007	+.0006	-.0007	-.0014	-.0006	-.0012	.0010	.0020
040	-.0007	-.0006	.0005	.0006	+.0007	+.0006	-.0007	-.0014	-.0006	-.0012	.0010	.0020
042	-.0007	-.0007	.0005	.0008	+.0007	+.0007	-.0007	-.0014	-.0007	-.0014	.0010	.0020
045	-.0007	-.0007	.0005	.0008	+.0007	+.0007	-.0007	-.0014	-.0007	-.0014	.0010	.0020
047	-.0008	-.0007	.0006	.0008	+.0008	+.0007	-.0008	-.0016	-.0007	-.0014	.0012	.0022
050	-.0008	-.0007	.0006	.0008	+.0008	+.0007	-.0008	-.0016	-.0007	-.0014	.0012	.0022
055	-.0008	-.0008	.0006	.0009	+.0008	+.0008	-.0008	-.0016	-.0008	-.0016	.0012	.0022
060	-.0008	-.0008	.0006	.0009	+.0008	+.0008	-.0008	-.0016	-.0008	-.0016	.0012	.0022
065	-.0008	-.0008	.0006	.0009	+.0008	+.0008	-.0008	-.0016	-.0008	-.0016	.0012	.0022
070	-.0008	-.0009	.0006	.0010	+.0008	+.0009	-.0008	-.0016	-.0009	-.0018	.0014	.0024
075	-.0009	-.0009	.0008	.0010	+.0009	+.0009	-.0009	-.0018	-.0009	-.0018	.0014	.0024
080	-.0009	-.0009	.0008	.0010	+.0009	+.0009	-.0009	-.0018	-.0009	-.0018	.0014	.0024
090	-.0009	-.0009	.0008	.0010	+.0009	+.0009	-.0009	-.0018	-.0009	-.0018	.0014	.0024
100	-.0010	-.0010	.0010	.0012	+.0010	+.0010	-.0010	-.0020	-.0010	-.0020	.0016	.0026
110	-.0010	-.0010	.0010	.0012	+.0010	+.0010	-.0010	-.0020	-.0010	-.0020	.0016	.0026
120	-.0010	-.0011	.0010	.0014	+.0010	+.0011	-.0010	-.0020	-.0011	-.0022	.0018	.0028
140	-.0010	-.0011	.0012	.0014	+.0010	+.0011	-.0010	-.0020	-.0011	-.0022	.0018	.0028
160	-.0011	-.0012	.0014	.0016	+.0011	+.0012	-.0011	-.0022	-.0012	-.0024	.0020	.0030
180	-.0011	-.0012	.0014	.0016	+.0011	+.0012	-.0011	-.0022	-.0012	-.0024	.0020	.0030
200	-.0012	-.0014	.0016	.0018	+.0012	+.0014	-.0012	-.0024	-.0014	-.0028	.0024	.0034

* Diametral clearance after installation theoretically can range rather widely if all contributing bearing, housing, and shaft tolerances are at either of their extremes. Diametral clearances shown do not apply to Type A (angular contact) bearings.

Listed shaft and housing diameters are for steel supports with standard bearing diametral clearance. Recommended shaft and housing diameters can change greatly based on orientation, temperature, speed, non-standard diametral clearances, and desired performance characteristics. Contact Kaydon for design assistance when required.

All dimensions in inches.

Total Width Tolerance—Duplexed Type A Bearings:
 Up thru 12" Bearing Bore +.000 –.010
 Over 12" Bearing Bore +.000 –.020
 Race Width Tolerance—Single Type C, X, A Bearings:
 Up thru 12" Bearing Bore +.000 –.005
 Over 12" Bearing Bore +.000 –.010

Precision Tolerances and Recommended Fits for Reali-Slim Bearings (continued)

Type C, X, and A with Endurakote Plating – Precision Class 4														
Bearing Size (Inch Series)	Bearing Diameters		Radial & Axial Runout				Rotating Shaft or Duplex DF Mounting		Stationary Shaft or Duplex DB Mounting				Bearing Diametral Clearance* (Type "X" and "C" only) Before Installation	
	Bearing Bore Nominal +.0000	Bearing O.D. Nominal +.0000	Inner Race		Outer Race		Shaft Diameter Nominal -.0000	Housing Bore Nominal -.0000	Shaft Diameter Nominal	Housing Bore Nominal				
			Radial	Axial	Radial	Axial								
010	-0.004	-0.004	.0002	.0003	.0002	.0003	+0.004	+0.004	-0.004	-0.008	-0.004	-0.008	.0005	.0009
015	-0.004	-0.004	.0002	.0003	.0002	.0003	+0.004	+0.004	-0.004	-0.008	-0.004	-0.008	.0005	.0009
017	-0.005	-0.005	.0002	.0003	.0003	.0004	+0.005	+0.005	-0.005	-0.010	-0.005	-0.010	.0006	.0012
020	-0.005	-0.005	.0002	.0003	.0003	.0004	+0.005	+0.005	-0.005	-0.010	-0.005	-0.010	.0006	.0012
025	-0.005	-0.005	.0002	.0003	.0003	.0004	+0.005	+0.005	-0.005	-0.010	-0.005	-0.010	.0006	.0012
030	-0.005	-0.005	.0002	.0003	.0004	.0005	+0.005	+0.005	-0.005	-0.010	-0.005	-0.010	.0006	.0012
035	-0.005	-0.005	.0003	.0004	.0004	.0005	+0.005	+0.005	-0.005	-0.010	-0.005	-0.010	.0006	.0012
040	-0.005	-0.005	.0003	.0004	.0004	.0005	+0.005	+0.005	-0.005	-0.010	-0.005	-0.010	.0006	.0012
042	-0.005	-0.006	.0003	.0004	.0004	.0005	+0.005	+0.006	-0.005	-0.010	-0.006	-0.012	.0008	.0014
045	-0.005	-0.006	.0003	.0004	.0004	.0005	+0.005	+0.006	-0.005	-0.010	-0.006	-0.012	.0008	.0014
047	-0.006	-0.006	.0003	.0004	.0004	.0005	+0.006	+0.006	-0.006	-0.012	-0.006	-0.012	.0008	.0014
050	-0.006	-0.006	.0003	.0004	.0004	.0005	+0.006	+0.006	-0.006	-0.012	-0.006	-0.012	.0008	.0014
055	-0.006	-0.007	.0003	.0004	.0005	.0006	+0.006	+0.007	-0.006	-0.012	-0.007	-0.014	.0010	.0016
060	-0.006	-0.007	.0003	.0004	.0005	.0006	+0.006	+0.007	-0.006	-0.012	-0.007	-0.014	.0010	.0016
065	-0.006	-0.007	.0003	.0004	.0005	.0006	+0.006	+0.007	-0.006	-0.012	-0.007	-0.014	.0010	.0016
070	-0.006	-0.007	.0003	.0004	.0005	.0006	+0.006	+0.007	-0.006	-0.012	-0.007	-0.014	.0010	.0016
075	-0.007	-0.007	.0004	.0005	.0005	.0006	+0.007	+0.007	-0.007	-0.014	-0.007	-0.014	.0010	.0016
080	-0.007	-0.007	.0004	.0005	.0005	.0006	+0.007	+0.007	-0.007	-0.014	-0.007	-0.014	.0010	.0016
090	-0.007	-0.007	.0004	.0005	.0005	.0006	+0.007	+0.007	-0.007	-0.014	-0.007	-0.014	.0010	.0016
100	-0.007	-0.007	.0005	.0006	.0006	.0007	+0.007	+0.007	-0.007	-0.014	-0.007	-0.014	.0010	.0016
110	-0.007	-0.007	.0005	.0006	.0006	.0007	+0.007	+0.007	-0.007	-0.014	-0.007	-0.014	.0010	.0016
120	-0.007	-0.008	.0005	.0006	.0007	.0008	+0.007	+0.008	-0.007	-0.014	-0.008	-0.016	.0012	.0018
140	-0.008	-0.008	.0005	.0007	.0007	.0008	+0.008	+0.008	-0.008	-0.016	-0.008	-0.016	.0012	.0018
160	-0.008	-0.009	.0007	.0008	.0008	.0009	+0.008	+0.009	-0.008	-0.016	-0.009	-0.018	.0014	.0020
180	-0.008	-0.009	.0007	.0008	.0008	.0009	+0.008	+0.009	-0.008	-0.016	-0.009	-0.018	.0014	.0020
200	-0.009	-0.010	.0008	.0009	.0009	.0010	+0.009	+0.010	-0.009	-0.018	-0.010	-0.020	.0016	.0022

* Diametral clearance after installation theoretically can range rather widely if all contributing bearing, housing, and shaft tolerances are at either of their extremes. Diametral clearances shown do not apply to Type A (angular contact) bearings.

Listed shaft and housing diameters are for steel supports with standard bearing diametral clearance. Recommended shaft and housing diameters can change greatly based on orientation, temperature, speed, non-standard diametral clearances, and desired performance characteristics. Contact Kaydon for design assistance when required.

Total Width Tolerance—Duplexed Type A Bearings:
 Up thru 12" Bearing Bore +.000 –.010
 Over 12" Bearing Bore +.000 –.020
 Race Width Tolerance—Single Type C, X, A Bearings:
 Up thru 12" Bearing Bore +.000 –.005
 Over 12" Bearing Bore +.000 –.010

All dimensions in inches.

Visit our website: www.kaydonbearings.com for latest releases, newest features, and downloads of catalogs, white papers, videos, software, and CAD drawings.

Premium Products Real-Slim® Thin Section Bearings

KAYDON
an SKF Group Brand

Kaydon Thinfinite bearing solutions

How Real-Slim® bearings outperform other thin section bearings

There are many reasons to choose Real-Slim® bearings for other applications. Real-Slim® bearings are not only lighter, but also more critical than Performance. They are designed to be lighter, but also to be longer than other bearings.

Inside by 40%, Real-Slim® bearings consistently outperform other thin section bearings. In the same applications, three competitor bearings that either 24 hours or 48 hours of operation will last only 10 hours - more than 4 times longer.

Feature	Real-Slim®	Competitor 1	Competitor 2	Competitor 3
Weight	100%	140%	150%	160%
Life	100%	25%	20%	15%

www.kaydonbearings.com

White Paper

KAYDON
an SKF Group Brand

4-point bearings do triple duty while saving space

by Bill Briggs and David Van Landuyt, Applied Bearings

The Advantages of Thin Section Bearings – Kaydo...

Ultra-Slim

99.9% weight reduction

97% reduction

Application testing - Kaydon Bearings

0:00 / 0:22

Home Search RFQ Suppliers Site map Contact

KAYDON About • Products • Markets • Resources • Distributors • Contact

Kaydon infinite bearing solutions

At Kaydon, we apply **infinite** engineering to solve the world's most demanding **infinite** solutions meet the most **aerospace and defense, commercial, industrial machinery, medical systems, mining, oil and gas, renewable energy, and semiconductor manufacturing markets.**

Thinfinite solutions in thin section bearings

Kaydon Thinfinite®: thin section bearing solutions save weight, create

800.514.3066 customer service

Please register with our new website for access to drawings and software. Already registered? Login below.

Enter your email address

News

Thin section bearings save weight and space- new video

How to select bearings for low-speed applications

Download the new Kaydon Commercial Aerospace brochure

SKF secures long-term agreement for Kaydon bearings with major wind turbine manufacturer

Visit Kaydon Bearings at 2014 AWEA Windpower show

Download Kaydon's new brochure: Wind Energy Bearings

Four-point bearings do triple duty while saving space

Kaydon earns Gold Boeing award

Home Search RFQ Suppliers Site map Contact

KAYDON About • Products • Markets • Resources • Distributors • Contact

Kaydon infinite bearing solutions

Videos

Thin section bearings

At Kaydon, we apply Thinfinite® engineering experience and expertise to solve the world's most unique bearing challenges. The Kaydon Real-Slim® inch-standard, thin section bearing is one of the most widely used thin section bearings in the world. Learn more about how Kaydon Thinfinite® bearing solutions save weight, create space, reduce friction, increase design flexibility, and provide excellent running accuracy.

Advantages of thin section bearings (3:32)

Research, development, and testing

Kaydon's infinite® engineering expertise and experience extends to the Kaydon Bearings research, development, and testing labs. Kaydon engineers use advanced analytical tools and calculations to understand, test, and recommend the best possible bearing solution for each customer and application.

800.514.3066 customer service

Enter your email address

Login to access drawings and engineering software

New user? Register

Videos

Thin section bearings Research, development, and testing

Stainless Steel Bearings (Material Code S)

Kaydon stainless steel bearings are used where high precision and corrosion resistance are required.

In today's manufacturing environment, bearings are often required:

- to operate in close proximity to corrosive chemicals
- to operate with lubricants which do not protect against corrosion
- to be ready-to-use, ultra-clean bearings with no preservative on them

Because any of these requirements would disqualify the use of standard 52100 steel material, Kaydon addressed these issues by offering Reali-Slim thin section bearings in AISI 440C stainless steel. This steel meets the minimum 58 HRc hardness level and can support the same loading as does 52100 chrome steel.

All bearings made of this material also utilize balls made of AISI 440C stainless steel.

Stainless Steel Reali-Slim thin section bearings minimize the surface degradation and particulate formation so common in harsh environment applications.

They are available:

- in AISI 440C stainless steel races
- with brass or non-metallic separators
- with either stainless steel or ceramic balls
- in popular sizes
- in either radial contact "C," angular contact "A," or four-point contact "X" configurations

NOTE: In addition to the open Reali-Slim bearings on the following pages, **many sealed Reali-Slim bearings are available in stainless steel.** Please refer to [pages 29-34](#) and, when ordering, replace the J in the part number with a W.



Stainless Steel Open Reali-Slim Bearings

Type A – ANGULAR CONTACT

A deep groove bearing with reduced shoulder on one side of inner or outer race ball path. Snap-over assembly permits use of a one-piece circular pocket ring separator and greater ball complement. These bearings will accept radial load and single direction thrust load and are normally used in conjunction with another bearing of similar construction. Type A bearings require

the application of thrust to establish contact angle. Stock bearings are individual units and when purchased as such must be adjusted at installation to desired running clearance or preload. If preferred, matched sets are available. Kaydon also offers matched spacers for applications requiring extra precision. Kaydon can provide this service direct from the factory.

SAA Series											
KAYDON Bearing Number	Dimensions in Inches					Capacities in Pounds ^①					Approx. Wt. in lbs.
	Size		Land Diameters			Dynamic			Static ^②		
	Bore	Outside Dia.	L ₁	L ₂	C'Bore L ₃	KAYDON Radial	ISO Radial ^③	Thrust	Radial	Thrust	
SAA10AGO	1.000	1.375	1.140	1.235	1.274	194	590	450	340	970	.025
SAA15AGO	1.500	1.875	1.640	1.735	1.774	238	681	560	480	1,380	.038
SAA17AGO	1.750	2.125	1.890	1.985	2.024	251	697	600	530	1,520	.045

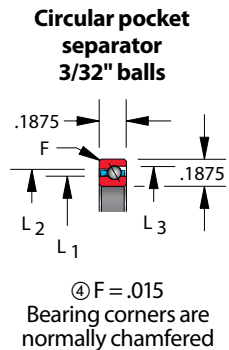

SA Series											
KAYDON Bearing Number	Dimensions in Inches					Capacities in Pounds ^①					Approx. Wt. in lbs.
	Size		Land Diameters			Dynamic			Static ^②		
	Bore	Outside Dia.	L ₁	L ₂	C'Bore L ₃	KAYDON Radial	ISO Radial ^③	Thrust	Radial	Thrust	
SA020ARO	2.000	2.500	2.186	2.314	2.369	405	1,065	960	790	2,280	.10
SA025ARO	2.500	3.000	2.686	2.814	2.869	459	1,150	1,100	960	2,780	.12
SA030ARO	3.000	3.500	3.186	3.314	3.367	507	1,225	1,230	1,140	3,290	.14
SA035ARO	3.500	4.000	3.686	3.814	3.867	552	1,292	1,350	1,310	3,790	.17
SA040ARO	4.000	4.500	4.186	4.314	4.367	595	1,353	1,470	1,490	4,300	.19
SA042ARO	4.250	4.750	4.436	4.564	4.615	616	1,382	1,530	1,580	4,550	.20
SA045ARO	4.500	5.000	4.686	4.814	4.865	637	1,410	1,580	1,660	4,810	.21
SA047ARO	4.750	5.250	4.936	5.064	5.115	657	1,437	1,640	1,750	5,060	.22
SA050ARO	5.000	5.500	5.186	5.314	5.365	676	1,463	1,690	1,840	5,310	.23
SA055ARO	5.500	6.000	5.686	5.814	5.863	715	1,513	1,800	2,020	5,820	.25
SA060ARO	6.000	6.500	6.186	6.314	6.363	752	1,561	1,900	2,190	6,320	.28
SA065ARO	6.500	7.000	6.686	6.814	6.861	788	1,605	2,000	2,370	6,830	.30
SA070ARO	7.000	7.500	7.186	7.314	7.361	823	1,648	2,100	2,540	7,340	.32
SA075ARO	7.500	8.000	7.686	7.814	7.861	857	1,689	2,190	2,720	7,840	.34
SA080ARO	8.000	8.500	8.186	8.314	8.359	890	1,728	2,280	2,890	8,350	.36
SA090ARO	9.000	9.500	9.186	9.314	9.357	954	1,802	2,470	3,240	9,360	.41
SA100ARO	10.000	10.500	10.186	10.314	10.355	1,014	1,871	2,640	3,590	10,370	.45
SA110ARO	11.000	11.500	11.186	11.314	11.353	1,072	1,936	2,810	3,940	11,380	.50
SA120ARO	12.000	12.500	12.186	12.314	12.349	1,128	1,998	2,970	4,290	12,390	.54

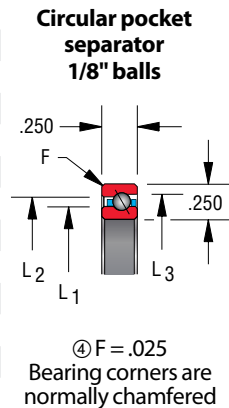

① Capacities listed are not simultaneous. For combined loading see discussion of [Bearing Selection](#) and [Load Analysis](#). Dynamic capacities are based upon 1 million revolutions of L10 life. Published capacities do not apply to hybrid series bearings P, X, and Y - contact Kaydon product engineering for values.

② Static capacities are non-brinell limits based on rigid support from the shaft and housing.

③ ISO Radial ratings are calculated per ISO 281:1990. They are included for comparison only (refer to [Page 95](#)).

④ "F" is the maximum shaft or housing fillet radius the bearing corners will clear.

Type A – Stainless Steel Open Reali-Slim Bearings, ANGULAR CONTACT

SB Series											
KAYDON Bearing Number	Dimensions in Inches					Capacities in Pounds ^①					Approx. Wt. in lbs.
	Size		Land Diameters			Dynamic			Static ^②		
	Bore	Outside Dia.	L ₁	L ₂	C'Bore L ₃	KAYDON Radial	ISO Radial ^③	Thrust	Radial	Thrust	
SB020ARO	2.000	2.625	2.231	2.393	2.464	601	1,520	1,380	1,090	3,150	.15
SB025ARO	2.500	3.125	2.731	2.893	2.964	675	1,650	1,590	1,340	3,860	.19
SB030ARO	3.000	3.625	3.231	3.393	3.462	734	1,737	1,750	1,550	4,470	.22
SB035ARO	3.500	4.125	3.731	3.893	3.962	801	1,840	1,930	1,790	5,180	.27
SB040ARO	4.000	4.625	4.231	4.393	4.460	865	1,934	2,100	2,040	5,890	.30
SB042ARO	4.250	4.875	4.481	4.643	4.710	891	1,967	2,170	2,150	6,200	.31
SB045ARO	4.500	5.125	4.731	4.893	4.960	917	2,000	2,240	2,250	6,500	.34
SB047ARO	4.750	5.375	4.981	5.143	5.210	951	2,051	2,340	2,390	6,910	.35
SB050ARO	5.000	5.625	5.231	5.393	5.460	976	2,081	2,410	2,500	7,210	.37
SB055ARO	5.500	6.125	5.731	5.893	5.958	1,033	2,158	2,560	2,740	7,920	.40
SB060ARO	6.000	6.625	6.231	6.393	6.458	1,088	2,230	2,710	2,990	8,630	.44
SB065ARO	6.500	7.125	6.731	6.893	6.958	1,132	2,281	2,840	3,200	9,240	.47
SB070ARO	7.000	7.625	7.231	7.393	7.456	1,184	2,347	2,980	3,450	9,960	.50
SB075ARO	7.500	8.125	7.731	7.893	7.955	1,235	2,409	3,120	3,700	10,670	.54
SB080ARO	8.000	8.625	8.231	8.393	8.453	1,284	2,469	3,260	3,940	11,380	.57
SB090ARO	9.000	9.625	9.231	9.393	9.451	1,370	2,568	3,510	4,400	12,700	.64
SB100ARO	10.000	10.625	10.231	10.393	10.449	1,461	2,673	3,760	4,890	14,120	.71
SB110ARO	11.000	11.625	11.231	11.393	11.447	1,540	2,760	4,000	5,350	15,440	.78
SB120ARO	12.000	12.625	12.231	12.393	12.445	1,623	2,853	4,240	5,840	16,860	.85
SB140ARO	14.000	14.625	14.231	14.393	14.439	1,767	3,005	4,670	6,760	19,500	.98
SB160ARO	16.000	16.625	16.231	16.393	16.433	1,907	3,154	5,100	7,710	22,250	1.12
SB180ARO	18.000	18.625	18.231	18.393	18.425	2,038	3,292	5,510	8,660	24,990	1.26
SB200ARO	20.000	20.625	20.231	20.393	20.416	2,162	3,421	5,900	9,610	27,730	1.40

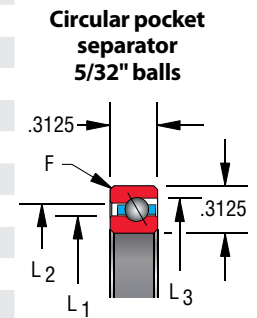

④ F = .040
Bearing corners are normally chamfered

① Capacities listed are not simultaneous. For combined loading see discussion of Bearing Selection and Load Analysis. Dynamic capacities are based upon 1 million revolutions of L10 life. Published capacities do not apply to hybrid series bearings P, X, and Y - contact Kaydon product engineering for values.
 ② Static capacities are non-brinell limits based on rigid support from the shaft and housing.
 ③ ISO Radial ratings are calculated per ISO 281:1990. They are included for comparison only (refer to Page 95).
 ④ "F" is the maximum shaft or housing fillet radius the bearing corners will clear.

CONTACT Kaydon at —
Kaydon Bearings • Muskegon, Michigan 49443
Telephone: 231-755-3741 • Fax: 231-759-4102



Need Service Fast?
1-800-514-3066
www.kaydonbearings.com



Type A – Stainless Steel Open Real-Slim Bearings, ANGULAR CONTACT

Selection Tables

Section 2

SC Series											
KAYDON Bearing Number	Dimensions in Inches					Capacities in Pounds ^①					Approx. Wt. in lbs.
	Size		Land Diameters			Dynamic		Static ^②			
	Bore	Outside Dia.	L ₁	L ₂	C' Bore L ₃	KAYDON Radial	ISO Radial ^③	Thrust	Radial	Thrust	
SC040ARO	4.000	4.750	4.277	4.473	4.554	1,153	2,520	2,770	2,550	7,360	.44
SC042ARO	4.250	5.000	4.527	4.723	4.804	1,194	2,580	2,880	2,710	7,820	.46
SC045ARO	4.500	5.250	4.777	4.973	5.052	1,234	2,637	2,990	2,860	8,270	.49
SC047ARO	4.750	5.500	5.027	5.223	5.302	1,274	2,693	3,100	3,020	8,720	.51
SC050ARO	5.000	5.750	5.277	5.473	5.552	1,313	2,746	3,200	3,180	9,170	.54
SC055ARO	5.500	6.250	5.777	5.973	6.052	1,374	2,820	3,370	3,440	9,920	.58
SC060ARO	6.000	6.750	6.277	6.473	6.550	1,448	2,917	3,580	3,750	10,820	.64
SC065ARO	6.500	7.250	6.777	6.973	7.050	1,519	3,009	3,770	4,060	11,720	.68
SC070ARO	7.000	7.750	7.277	7.473	7.550	1,575	3,071	3,930	4,320	12,470	.74
SC075ARO	7.500	8.250	7.777	7.973	8.048	1,642	3,156	4,120	4,630	13,380	.78
SC080ARO	8.000	8.750	8.277	8.473	8.548	1,708	3,236	4,300	4,950	14,280	.84
SC090ARO	9.000	9.750	9.277	9.473	9.546	1,822	3,366	4,630	5,520	15,930	.98
SC100ARO	10.000	10.750	10.277	10.473	10.544	1,942	3,508	4,970	6,140	17,730	1.04
SC110ARO	11.000	11.750	11.277	11.473	11.542	2,047	3,621	5,280	6,720	19,390	1.14
SC120ARO	12.000	12.750	12.277	12.473	12.540	2,147	3,729	5,570	7,290	21,040	1.23
SC140ARO	14.000	14.750	14.277	14.473	14.535	2,347	3,946	6,170	8,490	24,500	1.43
SC160ARO	16.000	16.750	16.277	16.473	16.529	2,533	4,144	6,730	9,680	27,950	1.63
SC180ARO	18.000	18.750	18.277	18.473	18.523	2,707	4,326	7,280	10,880	31,410	1.83
SC200ARO	20.000	20.750	20.277	20.473	20.517	2,863	4,484	7,780	12,030	34,720	2.03
SC250ARO	25.000	25.750	25.277	25.473	25.500	3,233	4,863	9,010	14,900	43,280	2.52

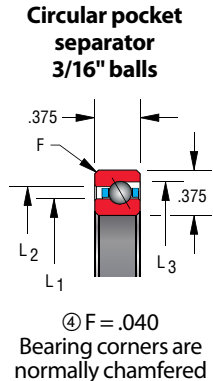

SD Series											
KAYDON Bearing Number	Dimensions in Inches					Capacities in Pounds ^①					Approx. Wt. in lbs.
	Size		Land Diameters			Dynamic		Static ^②			
	Bore	Outside Dia.	L ₁	L ₂	C' Bore L ₃	KAYDON Radial	ISO Radial ^③	Thrust	Radial	Thrust	
SD040ARO	4.000	5.000	4.370	4.630	4.741	1,819	3,708	4,260	3,550	10,260	.80
SD042ARO	4.250	5.250	4.620	4.880	4.991	1,876	3,786	4,420	3,750	10,830	.84
SD045ARO	4.500	5.500	4.870	5.130	5.241	1,931	3,861	4,570	3,950	11,400	.88
SD047ARO	4.750	5.750	5.120	5.380	5.490	1,986	3,934	4,720	4,150	11,970	.93
SD050ARO	5.000	6.000	5.370	5.630	5.740	2,040	4,004	4,870	4,340	12,540	.98
SD055ARO	5.500	6.500	5.870	6.130	6.238	2,145	4,138	5,160	4,740	13,680	1.06
SD060ARO	6.000	7.000	6.370	6.630	6.738	2,247	4,264	5,440	5,130	14,820	1.15
SD065ARO	6.500	7.500	6.870	7.130	7.236	2,346	4,384	5,720	5,530	15,960	1.24
SD070ARO	7.000	8.000	7.370	7.630	7.736	2,442	4,499	5,990	5,920	17,100	1.33
SD075ARO	7.500	8.500	7.870	8.130	8.236	2,536	4,608	6,250	6,320	18,240	1.42
SD080ARO	8.000	9.000	8.370	8.630	8.734	2,627	4,713	6,510	6,710	19,380	1.52
SD090ARO	9.000	10.000	9.370	9.630	9.732	2,803	4,911	7,010	7,500	21,660	1.69
SD100ARO	10.000	11.000	10.370	10.630	10.732	2,972	5,096	7,500	8,290	23,940	1.87
SD110ARO	11.000	12.000	11.370	11.630	11.730	3,133	5,270	7,960	9,080	26,220	2.05
SD120ARO	12.000	13.000	12.370	12.630	12.728	3,288	5,434	8,420	9,870	28,500	2.23
SD140ARO	14.000	15.000	14.370	14.630	14.724	3,582	5,739	9,290	11,450	33,060	2.57
SD160ARO	16.000	17.000	16.370	16.630	16.718	3,856	6,018	10,130	13,030	37,620	2.93
SD180ARO	18.000	19.000	18.370	18.630	18.712	4,113	6,276	10,930	14,610	42,180	3.29
SD200ARO	20.000	21.000	20.370	20.630	20.705	4,356	6,517	11,710	16,190	46,740	3.65
SD210ARO	21.000	22.000	21.370	21.630	21.700	4,472	6,632	12,086	16,981	49,020	3.83
SD250ARO	25.000	26.000	25.370	25.630	25.688	4,908	7,060	13,540	20,140	58,140	4.54

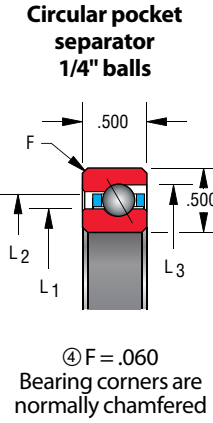

① Capacities listed are not simultaneous. For combined loading see discussion of [Bearing Selection](#) and [Load Analysis](#). Dynamic capacities are based upon 1 million revolutions of L10 life. Published capacities do not apply to hybrid series bearings P, X, and Y - contact Kaydon product engineering for values.

② Static capacities are non-brinell limits based on rigid support from the shaft and housing.

③ ISO Radial ratings are calculated per ISO 281:1990. They are included for comparison only (refer to [Page 95](#)).

④ "F" is the maximum shaft or housing fillet radius the bearing corners will clear.

Type A – Stainless Steel Open Reali-Slim Bearings, ANGULAR CONTACT

SF Series											
KAYDON Bearing Number	Dimensions in Inches					Capacities in Pounds ^①					Approx. Wt. in lbs.
	Size		Land Diameters			Dynamic			Static ^②		
	Bore	Outside Dia.	L ₁	L ₂	C'Bore L ₃	KAYDON Radial	ISO Radial ^③	Thrust	Radial	Thrust	
SF040AR0	4.000	5.500	4.555	4.945	5.115	3,736	6,809	8,420	6,350	18,340	1.92
SF042AR0	4.250	5.750	4.805	5.195	5.365	3,805	6,891	8,630	6,600	19,050	2.04
SF045AR0	4.500	6.000	5.055	5.445	5.615	3,966	7,134	9,050	7,090	20,460	2.14
SF047AR0	4.750	6.250	5.305	5.695	5.865	4,034	7,207	9,260	7,330	21,160	2.26
SF050AR0	5.000	6.500	5.555	5.945	6.115	4,101	7,279	9,460	7,570	21,870	2.37
SF055AR0	5.500	7.000	6.055	6.445	6.613	4,319	7,566	10,060	8,310	23,980	2.59
SF060AR0	6.000	7.500	6.555	6.945	7.113	4,530	7,835	10,650	9,040	26,100	2.72
SF065AR0	6.500	8.000	7.055	7.445	7.613	4,734	8,088	11,220	9,770	28,220	2.94
SF070AR0	7.000	8.500	7.555	7.945	8.113	4,932	8,329	11,770	10,510	30,330	3.16
SF075AR0	7.500	9.000	8.055	8.445	8.610	5,052	8,432	12,130	11,000	31,740	3.39
SF080AR0	8.000	9.500	8.555	8.945	9.110	5,242	8,655	12,670	11,730	33,860	3.61
SF090AR0	9.000	10.500	9.555	9.945	10.108	5,608	9,073	13,700	13,190	38,090	3.95
SF100AR0	10.000	11.500	10.555	10.945	11.106	5,890	9,353	14,530	14,420	41,620	4.40
SF110AR0	11.000	12.500	11.555	11.945	12.106	6,227	9,720	15,500	15,880	45,850	4.75
SF120AR0	12.000	13.500	12.555	12.945	13.104	6,487	9,969	16,290	17,100	49,380	5.20
SF140AR0	14.000	15.500	14.555	14.945	15.102	7,043	10,523	17,950	19,790	57,140	5.76
SF160AR0	16.000	17.500	16.555	16.945	17.098	7,563	11,030	19,540	22,480	64,890	6.78
SF180AR0	18.000	19.500	18.555	18.945	19.096	8,103	11,573	21,210	25,410	73,360	7.67
SF200AR0	20.000	21.500	20.555	20.945	21.092	8,562	12,006	22,680	28,100	81,120	8.47
SF250AR0	25.000	26.500	25.555	25.945	26.085	9,585	12,954	26,100	34,700	100,200	10.50

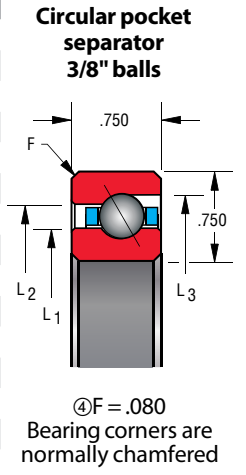

SG Series											
KAYDON Bearing Number	Dimensions in Inches					Capacities in Pounds ^①					Approx. Wt. in lbs.
	Size		Land Diameters			Dynamic			Static ^②		
	Bore	Outside Dia.	L ₁	L ₂	C'Bore L ₃	KAYDON Radial	ISO Radial ^③	Thrust	Radial	Thrust	
SG040AR0	4.000	6.000	4.742	5.258	5.491	6,281	10,167	13,630	9,480	27,360	3.61
SG042AR0	4.250	6.250	4.992	5.508	5.741	6,438	10,384	14,090	9,950	28,730	3.83
SG045AR0	4.500	6.500	5.242	5.758	5.989	6,562	10,592	14,530	10,430	30,100	3.95
SG047AR0	4.750	6.750	5.492	6.008	6.239	6,745	10,792	14,970	10,900	31,460	4.17
SG050AR0	5.000	7.000	5.742	6.258	6.489	6,897	10,985	15,400	11,370	32,830	4.42
SG055AR0	5.500	7.500	6.242	6.758	6.989	7,192	11,352	16,240	12,320	35,570	4.73
SG060AR0	6.000	8.000	6.742	7.258	7.489	7,480	11,697	17,060	13,270	38,300	5.07
SG065AR0	6.500	8.500	7.242	7.758	7.987	7,761	12,023	17,870	14,220	41,040	5.41
SG070AR0	7.000	9.000	7.742	8.258	8.487	8,035	12,333	18,650	15,160	43,780	5.87
SG075AR0	7.500	9.500	8.242	8.758	8.987	8,303	12,629	19,420	16,110	46,510	6.20
SG080AR0	8.000	10.000	8.742	9.258	9.485	8,566	12,912	20,180	17,060	49,250	6.54
SG090AR0	9.000	11.000	9.742	10.258	10.485	9,073	13,446	21,640	18,960	54,720	7.22
SG100AR0	10.000	12.000	10.742	11.258	11.483	9,561	13,942	23,060	20,850	60,190	8.00
SG110AR0	11.000	13.000	11.742	12.258	12.481	10,027	14,409	24,440	22,750	65,660	8.68
SG120AR0	12.000	14.000	12.742	13.258	13.481	10,481	14,849	25,780	24,640	71,140	9.47
SG140AR0	14.000	16.000	14.742	15.258	15.478	11,338	15,665	28,360	28,430	82,080	10.90
SG160AR0	16.000	18.000	16.742	17.258	17.474	12,142	16,411	30,830	32,220	93,020	12.40
SG180AR0	18.000	20.000	18.742	19.258	19.472	12,898	17,101	33,200	36,020	104,000	13.80
SG200AR0	20.000	22.000	20.742	21.258	21.468	13,612	17,745	35,490	39,810	114,900	15.20
SG220AR0	22.000	24.000	22.742	23.258	23.468	14,290	18,351	37,712	43,598	125,856	16.63
SG250AR0	25.000	27.000	25.742	26.258	26.461	15,239	19,198	40,920	49,280	142,300	18.80

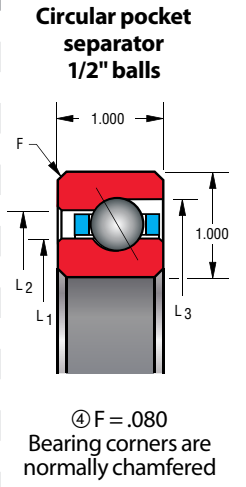

① Capacities listed are not simultaneous. For combined loading see discussion of Bearing Selection and Load Analysis. Dynamic capacities are based upon 1 million revolutions of L10 life. Published capacities do not apply to hybrid series bearings P, X, and Y - contact Kaydon product engineering for values.

② Static capacities are non-brinell limits based on rigid support from the shaft and housing.

③ ISO Radial ratings are calculated per ISO 281:1990. They are included for comparison only (refer to Page 95).

④ "F" is the maximum shaft or housing fillet radius the bearing corners will clear.

Stainless Steel Open Real-Slim Bearing Selections

Type C – RADIAL CONTACT

A Conrad assembled bearing designed primarily for application of radial load—deep ball grooves also permit application of

thrust load in either direction – often used in conjunction with another bearing.

SAA Series								
KAYDON Bearing Number	Dimensions in Inches				Capacities in Pounds ^①			Approx. Wt. in lbs.
	Size		Land Diameters		Dynamic		Static ^② Radial	
	Bore	Outside Dia.	L ₁	L ₂	KAYDON Radial	ISO Radial ^③		
SAA10CLO	1.000	1.375	1.140	1.235	188	558	290	.026
SAA15CLO	1.500	1.875	1.640	1.735	225	632	400	.039
SAA17CLO	1.750	2.125	1.890	1.985	242	663	460	.045

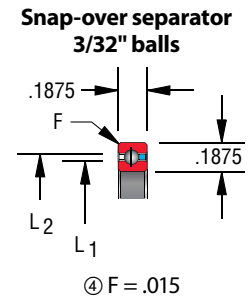

SA Series								
KAYDON Bearing Number	Dimensions in Inches				Capacities in Pounds ^①			Approx. Wt. in lbs.
	Size		Land Diameters		Dynamic		Static ^② Radial	
	Bore	Outside Dia.	L ₁	L ₂	KAYDON Radial	ISO Radial ^③		
SA020CP0	2.000	2.500	2.186	2.314	393	1,012	680	.10
SA025CP0	2.500	3.000	2.686	2.814	442	1,094	830	.13
SA030CP0	3.000	3.500	3.186	3.314	487	1,166	990	.15
SA035CP0	3.500	4.000	3.686	3.814	530	1,230	1,140	.18
SA040CP0	4.000	4.500	4.186	4.314	571	1,289	1,290	.19
SA042CP0	4.250	4.750	4.436	4.564	591	1,317	1,370	.20
SA045CP0	4.500	5.000	4.686	4.814	610	1,344	1,440	.22
SA047CP0	4.750	5.250	4.936	5.064	629	1,369	1,520	.23
SA050CP0	5.000	5.500	5.186	5.314	648	1,394	1,590	.24
SA055CP0	5.500	6.000	5.686	5.814	685	1,442	1,750	.25
SA060CP0	6.000	6.500	6.186	6.314	720	1,487	1,900	.28
SA065CP0	6.500	7.000	6.686	6.814	754	1,530	2,050	.30
SA070CP0	7.000	7.500	7.186	7.314	787	1,571	2,200	.31
SA075CP0	7.500	8.000	7.686	7.814	820	1,610	2,350	.34
SA080CP0	8.000	8.500	8.186	8.314	851	1,647	2,500	.38
SA090CP0	9.000	9.500	9.186	9.314	912	1,718	2,810	.44
SA100CP0	10.000	10.500	10.186	10.314	969	1,784	3,110	.50
SA110CP0	11.000	11.500	11.186	11.314	1,025	1,846	3,410	.52
SA120CP0	12.000	12.500	12.186	12.314	1,078	1,904	3,720	.56

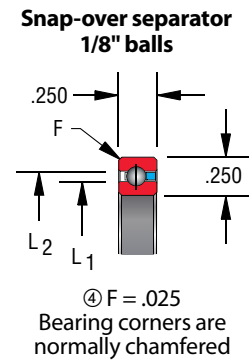

① Capacities listed are not simultaneous. For combined loading see discussion of [Bearing Selection](#) and [Load Analysis](#). Dynamic capacities are based upon 1 million revolutions of L10 life. Published capacities do not apply to hybrid series bearings P, X, and Y - contact Kaydon product engineering for values.

② Static capacities are non-brinell limits based on rigid support from the shaft and housing.

③ ISO Radial ratings are calculated per ISO 281:1990. They are included for comparison only (refer to [Page 95](#)).

④ "F" is the maximum shaft or housing fillet radius the bearing corners will clear.

Type C – Stainless Steel Open Reali-Slim Bearings, RADIAL CONTACT

SB Series								
KAYDON Bearing Number	Dimensions in Inches				Capacities in Pounds ^①			Approx. Wt. in lbs.
	Size		Land Diameters		Dynamic		Static ^② Radial	
	Bore	Outside Dia.	L ₁	L ₂	KAYDON Radial	ISO Radial ^③		
SB020CP0	2.000	2.625	2.231	2.393	577	1,431	930	.16
SB025CP0	2.500	3.125	2.731	2.893	644	1,549	1,140	.20
SB030CP0	3.000	3.625	3.231	3.393	707	1,651	1,340	.24
SB035CP0	3.500	4.125	3.731	3.893	767	1,743	1,540	.27
SB040CP0	4.000	4.625	4.231	4.393	825	1,827	1,750	.30
SB042CP0	4.250	4.875	4.481	4.643	846	1,853	1,830	.31
SB045CP0	4.500	5.125	4.731	4.893	880	1,904	1,950	.33
SB047CP0	4.750	5.375	4.981	5.143	901	1,928	2,030	.34
SB050CP0	5.000	5.625	5.231	5.393	933	1,976	2,150	.38
SB055CP0	5.500	6.125	5.731	5.893	984	2,044	2,360	.41
SB060CP0	6.000	6.625	6.231	6.393	1,034	2,108	2,560	.44
SB065CP0	6.500	7.125	6.731	6.893	1,082	2,168	2,760	.47
SB070CP0	7.000	7.625	7.231	7.393	1,129	2,226	2,970	.50
SB075CP0	7.500	8.125	7.731	7.893	1,175	2,281	3,170	.53
SB080CP0	8.000	8.625	8.231	8.393	1,219	2,334	3,370	.57
SB090CP0	9.000	9.625	9.231	9.393	1,304	2,434	3,780	.66
SB100CP0	10.000	10.625	10.231	10.393	1,386	2,527	4,190	.73
SB110CP0	11.000	11.625	11.231	11.393	1,464	2,615	4,590	.75
SB120CP0	12.000	12.625	12.231	12.393	1,539	2,698	5,000	.83
SB140CP0	14.000	14.625	14.231	14.393	1,680	2,851	5,810	1.05
SB160CP0	16.000	16.625	16.231	16.393	1,812	2,991	6,620	1.20
SB180CP0	18.000	18.625	18.231	18.393	1,936	3,121	7,440	1.35
SB200CP0	20.000	20.625	20.231	20.393	2,053	3,242	8,250	1.50

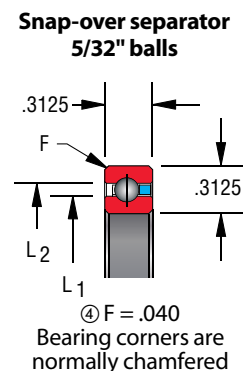

① Capacities listed are not simultaneous. For combined loading see discussion of [Bearing Selection](#) and [Load Analysis](#). Dynamic capacities are based upon 1 million revolutions of L10 life. Published capacities do not apply to hybrid series bearings P, X, and Y - contact Kaydon product engineering for values.

② Static capacities are non-brinell limits based on rigid support from the shaft and housing.

③ ISO Radial ratings are calculated per ISO 281:1990. They are included for comparison only (refer to [Page 95](#)).

④ "F" is the maximum shaft or housing fillet radius the bearing corners will clear.

CONTACT Kaydon at —
Kaydon Bearings • Muskegon, Michigan 49443
Telephone: 231-755-3741 • Fax: 231-759-4102



Need Service Fast?
1-800-514-3066
www.kaydonbearings.com



Type C – Stainless Steel Open Real-Slim Bearings, RADIAL CONTACT

Selection Tables

Section 2

SC Series								
KAYDON Bearing Number	Dimensions in Inches				Capacities in Pounds ^①			Approx. Wt. in lbs.
	Size		Land Diameters		Dynamic		Static ^②	
	Bore	Outside Dia.	L ₁	L ₂	KAYDON Radial	ISO Radial ^③	Radial	
SC040CP0	4.000	4.750	4.277	4.473	1,073	2,321	2,100	.45
SC042CP0	4.250	5.000	4.527	4.723	1,108	2,370	2,220	.47
SC045CP0	4.500	5.250	4.777	4.973	1,143	2,418	2,340	.48
SC047CP0	4.750	5.500	5.027	5.223	1,176	2,464	2,460	.50
SC050CP0	5.000	5.750	5.277	5.473	1,209	2,509	2,590	.58
SC055CP0	5.500	6.250	5.777	5.973	1,274	2,594	2,830	.59
SC060CP0	6.000	6.750	6.277	6.473	1,337	2,674	3,070	.63
SC065CP0	6.500	7.250	6.777	6.973	1,397	2,751	3,310	.68
SC070CP0	7.000	7.750	7.277	7.473	1,457	2,823	3,550	.73
SC075CP0	7.500	8.250	7.777	7.973	1,514	2,893	3,790	.78
SC080CP0	8.000	8.750	8.277	8.473	1,570	2,960	4,030	.84
SC090CP0	9.000	9.750	9.277	9.473	1,678	3,085	4,510	.94
SC100CP0	10.000	10.750	10.277	10.473	1,781	3,203	4,990	1.06
SC110CP0	11.000	11.750	11.277	11.473	1,879	3,313	5,470	1.16
SC120CP0	12.000	12.750	12.277	12.473	1,974	3,417	5,950	1.25
SC140CP0	14.000	14.750	14.277	14.473	2,154	3,611	6,910	1.52
SC160CP0	16.000	16.750	16.277	16.473	2,321	3,787	7,880	1.73
SC180CP0	18.000	18.750	18.277	18.473	2,478	3,951	8,840	1.94
SC200CP0	20.000	20.750	20.277	20.473	2,626	4,104	9,800	2.16
SC250CP0	25.000	25.750	25.277	25.473	2,962	4,447	12,200	2.69

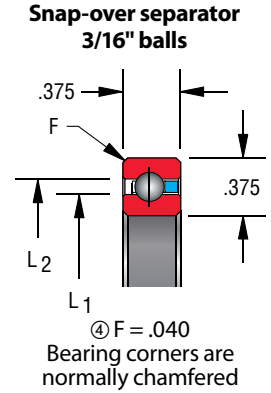

SD Series								
KAYDON Bearing Number	Dimensions in Inches				Capacities in Pounds ^①			Approx. Wt. in lbs.
	Size		Land Diameters		Dynamic		Static ^②	
	Bore	Outside Dia.	L ₁	L ₂	KAYDON Radial	ISO Radial ^③	Radial	
SD040CP0	4.000	5.000	4.370	4.630	1,755	3,523	3,080	.78
SD042CP0	4.250	5.250	4.620	4.880	1,787	3,556	3,190	.83
SD045CP0	4.500	5.500	4.870	5.130	1,861	3,671	3,420	.88
SD047CP0	4.750	5.750	5.120	5.380	1,892	3,701	3,530	.94
SD050CP0	5.000	6.000	5.370	5.630	1,964	3,808	3,760	1.00
SD055CP0	5.500	6.500	5.870	6.130	2,063	3,937	4,100	1.06
SD060CP0	6.000	7.000	6.370	6.630	2,160	4,059	4,450	1.16
SD065CP0	6.500	7.500	6.870	7.130	2,254	4,174	4,790	1.22
SD070CP0	7.000	8.000	7.370	7.630	2,345	4,284	5,130	1.31
SD075CP0	7.500	8.500	7.870	8.130	2,434	4,388	5,470	1.41
SD080CP0	8.000	9.000	8.370	8.630	2,520	4,489	5,810	1.53
SD090CP0	9.000	10.000	9.370	9.630	2,688	4,678	6,500	1.72
SD100CP0	10.000	11.000	10.370	10.630	2,847	4,855	7,180	1.88
SD110CP0	11.000	12.000	11.370	11.630	3,000	5,021	7,870	2.06
SD120CP0	12.000	13.000	12.370	12.630	3,148	5,178	8,550	2.25
SD140CP0	14.000	15.000	14.370	14.630	3,427	5,469	9,920	2.73
SD160CP0	16.000	17.000	16.370	16.630	3,688	5,736	11,290	3.10
SD180CP0	18.000	19.000	18.370	18.630	3,933	5,982	12,650	3.48
SD200CP0	20.000	21.000	20.370	20.630	4,164	6,212	14,020	3.85
SD210CP0	21.000	22.000	21.370	21.630	4,274	6,321	14,706	4.04
SD250CP0	25.000	26.000	25.370	25.630	4,689	6,729	17,440	4.79

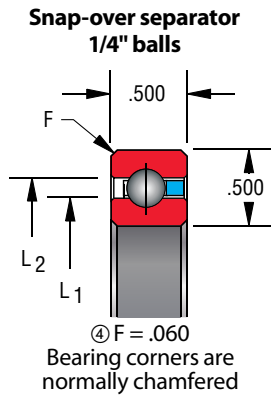

① Capacities listed are not simultaneous. For combined loading see discussion of Bearing Selection and Load Analysis. Dynamic capacities are based upon 1 million revolutions of L10 life. Published capacities do not apply to hybrid series bearings P, X, and Y - contact Kaydon product engineering for values.

② Static capacities are non-brinell limits based on rigid support from the shaft and housing.

③ ISO Radial ratings are calculated per ISO 281:1990. They are included for comparison only (refer to Page 95).

④ "F" is the maximum shaft or housing fillet radius the bearing corners will clear.

Type C – Stainless Steel Open Real-i-Slim Bearings, RADIAL CONTACT

SF Series								
KAYDON Bearing Number	Dimensions in Inches				Capacities in Pounds ^①			Approx. Wt. in lbs.
	Size		Land Diameters		Dynamic		Static ^②	
	Bore	Outside Dia.	L ₁	L ₂	KAYDON Radial	ISO Radial ^③	Radial	
SF040CP0	4.000	5.500	4.555	4.945	3,559	6,334	5,360	1.9
SF042CP0	4.250	5.750	4.805	5.195	3,655	6,472	5,640	2.0
SF045CP0	4.500	6.000	5.055	5.445	3,750	6,605	5,930	2.1
SF047CP0	4.750	6.250	5.305	5.695	3,843	6,732	6,210	2.2
SF050CP0	5.000	6.500	5.555	5.945	3,936	6,855	6,490	2.3
SF055CP0	5.500	7.000	6.055	6.445	4,116	7,089	7,050	2.5
SF060CP0	6.000	7.500	6.555	6.945	4,291	7,308	7,620	2.7
SF065CP0	6.500	8.000	7.055	7.445	4,461	7,516	8,180	2.9
SF070CP0	7.000	8.500	7.555	7.945	4,628	7,713	8,750	3.2
SF075CP0	7.500	9.000	8.055	8.445	4,791	7,901	9,310	3.4
SF080CP0	8.000	9.500	8.555	8.945	4,949	8,081	9,880	3.5
SF090CP0	9.000	10.500	9.555	9.945	5,256	8,421	11,000	3.9
SF100CP0	10.000	11.500	10.555	10.945	5,550	8,737	12,130	4.3
SF110CP0	11.000	12.500	11.555	11.945	5,833	9,033	13,260	4.8
SF120CP0	12.000	13.500	12.555	12.945	6,105	9,313	14,390	5.2
SF140CP0	14.000	15.500	14.555	14.945	6,620	9,832	16,650	6.0
SF160CP0	16.000	17.500	16.555	16.945	7,104	10,306	18,900	7.1
SF180CP0	18.000	19.500	18.555	18.945	7,557	10,744	21,160	7.9
SF200CP0	20.000	21.500	20.555	20.945	7,986	11,153	23,420	8.9
SF250CP0	25.000	26.500	25.555	25.945	8,963	12,074	29,060	10.9

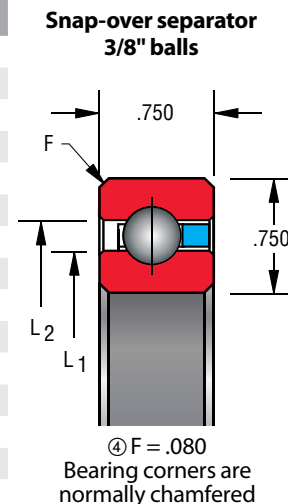

SG Series								
KAYDON Bearing Number	Dimensions in Inches				Capacities in Pounds ^①			Approx. Wt. in lbs.
	Size		Land Diameters		Dynamic		Static ^②	
	Bore	Outside Dia.	L ₁	L ₂	KAYDON Radial	ISO Radial ^③	Radial	
SG040CP0	4.000	6.000	4.742	5.258	6,115	9,579	8,210	3.6
SG042CP0	4.250	6.250	4.992	5.508	6,061	9,481	8,210	3.8
SG045CP0	4.500	6.500	5.242	5.758	6,227	9,797	8,760	4.0
SG047CP0	4.750	6.750	5.492	6.008	6,487	10,099	9,300	4.1
SG050CP0	5.000	7.000	5.742	6.258	6,691	10,388	9,850	4.3
SG055CP0	5.500	7.500	6.242	6.758	6,850	10,563	10,400	4.7
SG060CP0	6.000	8.000	6.742	7.258	7,241	11,085	11,490	5.1
SG065CP0	6.500	8.500	7.242	7.758	7,393	11,234	12,040	5.4
SG070CP0	7.000	9.000	7.742	8.258	7,764	11,705	13,130	5.8
SG075CP0	7.500	9.500	8.242	8.758	7,911	11,835	13,680	6.1
SG080CP0	8.000	10.000	8.742	9.258	8,265	12,266	14,770	6.5
SG090CP0	9.000	11.000	9.742	10.258	8,743	12,782	16,420	7.2
SG100CP0	10.000	12.000	10.742	11.258	9,204	13,261	18,060	7.9
SG110CP0	11.000	13.000	11.742	12.258	9,648	13,710	19,700	8.6
SG120CP0	12.000	14.000	12.742	13.258	10,074	14,133	21,340	9.3
SG140CP0	14.000	16.000	14.742	15.258	10,886	14,916	24,620	10.8
SG160CP0	16.000	18.000	16.742	17.258	11,648	15,631	27,910	12.3
SG180CP0	18.000	20.000	18.742	19.258	12,367	16,291	31,190	13.7
SG200CP0	20.000	22.000	20.742	21.258	13,044	16,907	34,470	15.8
SG220CP0	22.000	24.000	22.742	23.258	13,685	17,486	37,757	16.8
SG250CP0	25.000	27.000	25.742	26.258	14,591	18,295	42,680	19.5

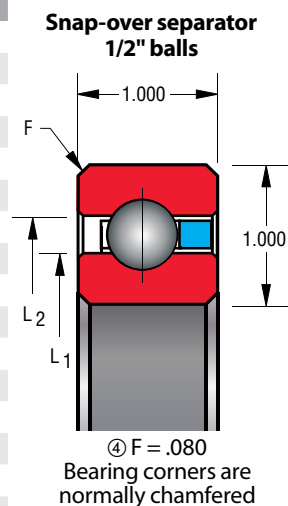

① Capacities listed are not simultaneous. For combined loading see discussion of [Bearing Selection](#) and [Load Analysis](#). Dynamic capacities are based upon 1 million revolutions of L10 life. Published capacities do not apply to hybrid series bearings P, X, and Y - contact Kaydon product engineering for values.
 ② Static capacities are non-brinell limits based on rigid support from the shaft and housing.
 ③ ISO Radial ratings are calculated per ISO 281:1990. They are included for comparison only (refer to [Page 95](#)).
 ④ "F" is the maximum shaft or housing fillet radius the bearing corners will clear.

Stainless Steel Open Real-Slim Bearing Selections

Type X – FOUR-POINT CONTACT

A Conrad assembled bearing designed for applications involving multiple loads. Unique internal geometry permits application of radial load, thrust load in either direction, and moment load,

individually or in any combination. A single four-point contact bearing may replace two bearings in many applications.

Selection Tables

Section 2

SAA Series												
KAYDON Bearing Number	Dimensions in Inches				Capacities ^①						Approx. Wt. in lbs.	
	Size		Land Diameters		Dynamic			Static ^②				
	Bore	Outside Dia.	L ₁	L ₂	Radial (lbs)	Thrust (lbs)	Moment (in-lbs)	Radial (lbs)	Thrust (lbs)	Moment (in-lbs)		
SAA10XLO	1.000	1.375	1.140	1.235	247	370	110	290	730	170	.026	
SAA15XLO	1.500	1.875	1.640	1.735	296	460	187	400	1,000	340	.039	
SAA17XLO	1.750	2.125	1.890	1.985	319	500	232	460	1,140	440	.045	

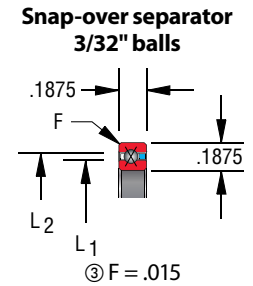

SA Series												
KAYDON Bearing Number	Dimensions in Inches				Capacities ^①						Approx. Wt. in lbs.	
	Size		Land Diameters		Dynamic			Static ^②				
	Bore	Outside Dia.	L ₁	L ₂	Radial (lbs)	Thrust (lbs)	Moment (in-lbs)	Radial (lbs)	Thrust (lbs)	Moment (in-lbs)		
SA020XP0	2.000	2.500	2.186	2.314	514	790	434	680	1,710	770	.10	
SA025XP0	2.500	3.000	2.686	2.814	583	910	601	830	2,090	1,150	.13	
SA027XP0	2.750	3.250	2.936	3.064	614	960	690	910	2,275	1,365	.14	
SA030XP0	3.000	3.500	3.186	3.314	643	1,010	785	990	2,470	1,600	.15	
SA035XP0	3.500	4.000	3.686	3.814	701	1,110	986	1,140	2,850	2,130	.18	
SA040XP0	4.000	4.500	4.186	4.314	756	1,210	1,205	1,290	3,220	2,740	.19	
SA042XP0	4.250	4.750	4.436	4.564	783	1,260	1,321	1,370	3,410	3,070	.20	
SA045XP0	4.500	5.000	4.686	4.814	809	1,310	1,441	1,440	3,600	3,420	.22	
SA047XP0	4.750	5.250	4.936	5.064	834	1,350	1,565	1,520	3,790	3,790	.23	
SA050XP0	5.000	5.500	5.186	5.314	859	1,400	1,693	1,590	3,980	4,180	.24	
SA055XP0	5.500	6.000	5.686	5.814	908	1,480	1,959	1,750	4,360	5,020	.25	
SA060XP0	6.000	6.500	6.186	6.314	955	1,570	2,240	1,900	4,740	5,930	.28	
SA065XP0	6.500	7.000	6.686	6.814	1,001	1,650	2,535	2,050	5,120	6,910	.30	
SA070XP0	7.000	7.500	7.186	7.314	1,046	1,730	2,844	2,200	5,500	7,980	.31	
SA075XP0	7.500	8.000	7.686	7.814	1,089	1,810	3,165	2,350	5,880	9,120	.34	
SA080XP0	8.000	8.500	8.186	8.314	1,131	1,890	3,499	2,500	6,260	10,330	.38	
SA090XP0	9.000	9.500	9.186	9.314	1,212	2,040	4,204	2,810	7,020	12,990	.44	
SA100XP0	10.000	10.500	10.186	10.314	1,289	2,180	4,956	3,110	7,780	15,940	.50	
SA110XP0	11.000	11.500	11.186	11.314	1,362	2,320	5,750	3,410	8,540	19,210	.52	
SA120XP0	12.000	12.500	12.186	12.314	1,433	2,450	6,587	3,720	9,300	22,770	.56	

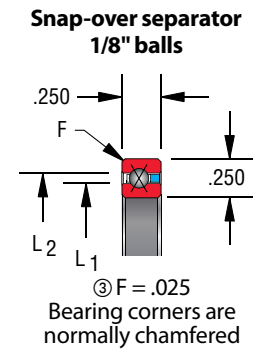

① Capacities listed are not simultaneous. For combined loading see discussion of Bearing Selection and Load Analysis. Dynamic capacities are based upon 1 million revolutions of L10 life. Published capacities do not apply to hybrid series bearings P, X, and Y - contact Kaydon product engineering for values.

② Static capacities are non-brinell limits based on rigid support from the shaft and housing.

③ "F" is the maximum shaft or housing fillet radius the bearing corners will clear.

Type X – Stainless Steel Open Reali-Slim Bearings, FOUR-POINT CONTACT

SB Series											
KAYDON Bearing Number	Dimensions in Inches				Capacities ^①						Approx. Wt. in lbs.
	Size		Land Diameters		Dynamic			Static ^②			
	Bore	Outside Dia.	L ₁	L ₂	Radial (lbs)	Thrust (lbs)	Moment (in-lbs)	Radial (lbs)	Thrust (lbs)	Moment (in-lbs)	
SB020XP0	2.000	2.625	2.231	2.393	758	1,130	658	930	2,340	1,080	.16
SB025XP0	2.500	3.125	2.731	2.893	848	1,290	895	1,140	2,840	1,600	.19
SB030XP0	3.000	3.625	3.231	3.393	933	1,440	1,159	1,340	3,350	2,220	.24
SB035XP0	3.500	4.125	3.731	3.893	1,014	1,590	1,450	1,540	3,860	2,940	.27
SB040XP0	4.000	4.625	4.231	4.393	1,091	1,720	1,764	1,750	4,370	3,770	.30
SB042XP0	4.250	4.875	4.481	4.643	1,120	1,780	1,917	1,830	4,570	4,170	.31
SB045XP0	4.500	5.125	4.731	4.893	1,165	1,850	2,103	1,950	4,880	4,690	.33
SB047XP0	4.750	5.375	4.981	5.143	1,193	1,900	2,265	2,030	5,080	5,140	.34
SB050XP0	5.000	5.625	5.231	5.393	1,236	1,980	2,463	2,150	5,380	5,720	.38
SB055XP0	5.500	6.125	5.731	5.893	1,304	2,100	2,844	2,360	5,890	6,850	.41
SB060XP0	6.000	6.625	6.231	6.393	1,371	2,220	3,247	2,560	6,400	8,080	.44
SB065XP0	6.500	7.125	6.731	6.893	1,435	2,340	3,668	2,760	6,910	9,410	.47
SB070XP0	7.000	7.625	7.231	7.393	1,498	2,450	4,109	2,970	7,420	10,850	.50
SB075XP0	7.500	8.125	7.731	7.893	1,559	2,560	4,568	3,170	7,920	12,380	.53
SB080XP0	8.000	8.625	8.231	8.393	1,618	2,670	5,045	3,370	8,430	14,020	.57
SB090XP0	9.000	9.625	9.231	9.393	1,732	2,880	6,050	3,780	9,450	17,600	.66
SB100XP0	10.000	10.625	10.231	10.393	1,841	3,080	7,121	4,190	10,460	21,580	.73
SB110XP0	11.000	11.625	11.231	11.393	1,945	3,280	8,254	4,590	11,480	25,970	.75
SB120XP0	12.000	12.625	12.231	12.393	2,045	3,470	9,446	5,000	12,500	30,770	.83
SB140XP0	14.000	14.625	14.231	14.393	2,234	3,840	11,994	5,810	14,530	41,580	1.05
SB160XP0	16.000	16.625	16.231	16.393	2,410	4,190	14,750	6,620	16,560	54,020	1.20
SB180XP0	18.000	18.625	18.231	18.393	2,576	4,520	17,694	7,440	18,590	68,090	1.35
SB200XP0	20.000	20.625	20.231	20.393	2,731	4,850	20,813	8,250	20,620	83,780	1.50

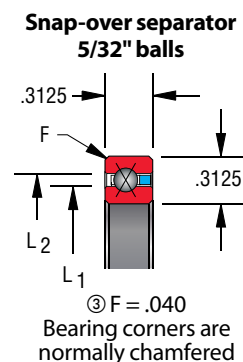

① Capacities listed are not simultaneous. For combined loading see discussion of [Bearing Selection](#) and [Load Analysis](#). Dynamic capacities are based upon 1 million revolutions of L10 life. Published capacities do not apply to hybrid series bearings P, X, and Y - contact Kaydon product engineering for values.
 ② Static capacities are non-brinell limits based on rigid support from the shaft and housing.
 ③ "F" is the maximum shaft or housing fillet radius the bearing corners will clear.

CONTACT Kaydon at —
Kaydon Bearings • Muskegon, Michigan 49443
Telephone: 231-755-3741 • Fax: 231-759-4102



Need Service Fast?
1-800-514-3066
www.kaydonbearings.com



Type X – Stainless Steel Open Real-Slim Bearings, FOUR-POINT CONTACT

Selection Tables
Section 2

SC Series											
KAYDON Bearing Number	Dimensions in Inches				Capacities ^①						Approx. Wt. in lbs.
	Size		Land Diameters		Dynamic			Static ^②			
	Bore	Outside Dia.	L ₁	L ₂	Radial (lbs)	Thrust (lbs)	Moment (in-lbs)	Radial (lbs)	Thrust (lbs)	Moment (in-lbs)	
SC040XP0	4.000	4.750	4.277	4.473	1,417	2,210	2,326	2,100	5,260	4,600	.45
SC042XP0	4.250	5.000	4.527	4.723	1,464	2,290	2,541	2,220	5,560	5,140	.47
SC045XP0	4.500	5.250	4.777	4.973	1,510	2,380	2,762	2,340	5,860	5,710	.48
SC047XP0	4.750	5.500	5.027	5.223	1,556	2,460	2,991	2,460	6,160	6,320	.50
SC050XP0	5.000	5.750	5.277	5.473	1,600	2,540	3,226	2,590	6,460	6,950	.58
SC055XP0	5.500	6.250	5.777	5.973	1,687	2,690	3,717	2,830	7,060	8,300	.59
SC060XP0	6.000	6.750	6.277	6.473	1,770	2,840	4,234	3,070	7,660	9,770	.63
SC065XP0	6.500	7.250	6.777	6.973	1,851	2,990	4,775	3,310	8,270	11,370	.68
SC070XP0	7.000	7.750	7.277	7.473	1,931	3,130	5,341	3,550	8,870	13,080	.73
SC075XP0	7.500	8.250	7.777	7.973	2,007	3,270	5,930	3,790	9,470	14,910	.78
SC080XP0	8.000	8.750	8.277	8.473	2,082	3,410	6,542	4,030	10,070	16,870	.84
SC090XP0	9.000	9.750	9.277	9.473	2,226	3,670	7,830	4,510	11,270	21,130	.94
SC100XP0	10.000	10.750	10.277	10.473	2,364	3,930	9,201	4,990	12,470	25,880	1.06
SC110XP0	11.000	11.750	11.277	11.473	2,496	4,180	10,651	5,470	13,680	31,110	1.16
SC120XP0	12.000	12.750	12.277	12.473	2,622	4,420	12,174	5,950	14,880	36,830	1.25
SC140XP0	14.000	14.750	14.277	14.473	2,862	4,890	15,434	6,910	17,280	49,690	1.52
SC160XP0	16.000	16.750	16.277	16.473	3,086	5,330	18,955	7,880	19,690	64,480	1.73
SC180XP0	18.000	18.750	18.277	18.473	3,295	5,760	22,712	8,840	22,090	81,190	1.94
SC200XP0	20.000	20.750	20.277	20.473	3,492	6,170	26,695	9,800	24,500	99,830	2.16
SC250XP0	25.000	25.750	25.277	25.473	3,941	7,140	37,518	12,200	30,510	154,800	2.69

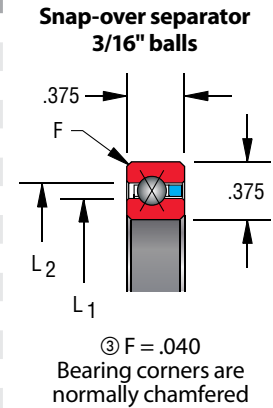

SD Series											
KAYDON Bearing Number	Dimensions in Inches				Capacities ^①						Approx. Wt. in lbs.
	Size		Land Diameters		Dynamic			Static ^②			
	Bore	Outside Dia.	L ₁	L ₂	Radial (lbs)	Thrust (lbs)	Moment (in-lbs)	Radial (lbs)	Thrust (lbs)	Moment (in-lbs)	
SD040XP0	4.000	5.000	4.370	4.630	2,311	3,520	3,901	3,080	7,700	6,930	.78
SD042XP0	4.250	5.250	4.620	4.880	2,355	3,600	4,196	3,190	7,980	7,580	.83
SD045XP0	4.500	5.500	4.870	5.130	2,454	3,770	4,602	3,420	8,550	8,550	.88
SD047XP0	4.750	5.750	5.120	5.380	2,496	3,860	4,916	3,530	8,840	9,280	.94
SD050XP0	5.000	6.000	5.370	5.630	2,592	4,020	5,348	3,760	9,410	10,350	1.00
SD055XP0	5.500	6.500	5.870	6.130	2,725	4,260	6,134	4,100	10,260	12,310	1.06
SD060XP0	6.000	7.000	6.370	6.630	2,855	4,490	6,961	4,450	11,120	14,450	1.16
SD065XP0	6.500	7.500	6.870	7.130	2,980	4,720	7,826	4,790	11,970	16,760	1.22
SD070XP0	7.000	8.000	7.370	7.630	3,103	4,940	8,730	5,130	12,830	19,240	1.31
SD075XP0	7.500	8.500	7.870	8.130	3,222	5,160	9,669	5,470	13,680	21,890	1.41
SD080XP0	8.000	9.000	8.370	8.630	3,338	5,370	10,643	5,810	14,540	24,710	1.53
SD090XP0	9.000	10.000	9.370	9.630	3,561	5,790	12,693	6,500	16,250	30,870	1.72
SD100XP0	10.000	11.000	10.370	10.630	3,776	6,190	14,872	7,180	17,960	37,710	1.88
SD110XP0	11.000	12.000	11.370	11.630	3,981	6,570	17,173	7,870	19,670	45,230	2.06
SD120XP0	12.000	13.000	12.370	12.630	4,178	6,950	19,590	8,550	21,380	53,440	2.25
SD140XP0	14.000	15.000	14.370	14.630	4,551	7,670	24,755	9,920	24,800	71,910	2.73
SD160XP0	16.000	17.000	16.370	16.630	4,899	8,360	30,325	11,290	28,220	93,110	3.10
SD180XP0	18.000	19.000	18.370	18.630	5,226	9,030	36,268	12,650	31,640	117,000	3.48
SD200XP0	20.000	21.000	20.370	20.630	5,534	9,670	42,561	14,020	35,060	143,700	3.85
SD210XP0	21.000	22.000	21.370	21.630	5,682	9,980	45,826	14,710	36,770	158,100	4.04
SD250XP0	25.000	26.000	25.370	25.630	6,235	11,180	59,649	17,440	43,610	222,400	4.79

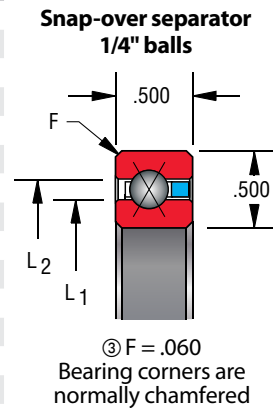

① Capacities listed are not simultaneous. For combined loading see discussion of [Bearing Selection](#) and [Load Analysis](#). Dynamic capacities are based upon 1 million revolutions of L10 life. Published capacities do not apply to hybrid series bearings P, X, and Y - contact Kaydon product engineering for values.

② Static capacities are non-brinell limits based on rigid support from the shaft and housing.

③ "F" is the maximum shaft or housing fillet radius the bearing corners will clear.

Type X – Stainless Steel Open Reali-Slim Bearings, FOUR-POINT CONTACT

SF Series											
KAYDON Bearing Number	Dimensions in Inches				Capacities ^①						Approx. Wt. in lbs.
	Size		Land Diameters		Dynamic			Static ^②			
	Bore	Outside Dia.	L ₁	L ₂	Radial (lbs)	Thrust (lbs)	Moment (in-lbs)	Radial (lbs)	Thrust (lbs)	Moment (in-lbs)	
SF040XP0	4.000	5.500	4.555	4.945	4,665	6,830	8,312	5,360	13,400	12,730	1.9
SF042XP0	4.250	5.750	4.805	5.195	4,795	7,070	8,993	5,640	14,110	14,110	2.0
SF045XP0	4.500	6.000	5.055	5.445	4,923	7,300	9,695	5,930	14,810	15,550	2.1
SF047XP0	4.750	6.250	5.305	5.695	5,048	7,530	10,416	6,210	15,520	17,070	2.2
SF050XP0	5.000	6.500	5.555	5.945	5,172	7,760	11,157	6,490	16,220	18,660	2.3
SF055XP0	5.500	7.000	6.055	6.445	5,415	8,200	12,696	7,050	17,630	22,040	2.5
SF060XP0	6.000	7.500	6.555	6.945	5,651	8,630	14,311	7,620	19,050	25,710	2.7
SF065XP0	6.500	8.000	7.055	7.445	5,880	9,050	15,993	8,180	20,460	29,660	2.9
SF070XP0	7.000	8.500	7.555	7.945	6,103	9,460	17,744	8,750	21,870	33,890	3.2
SF075XP0	7.500	9.000	8.055	8.445	6,323	9,870	19,568	9,310	23,280	38,410	3.4
SF080XP0	8.000	9.500	8.555	8.945	6,535	10,260	21,453	9,880	24,690	43,200	3.5
SF090XP0	9.000	10.500	9.555	9.945	6,947	11,030	25,410	11,000	27,510	53,640	3.9
SF100XP0	10.000	11.500	10.555	10.945	7,342	11,770	29,608	12,130	30,330	65,210	4.3
SF110XP0	11.000	12.500	11.555	11.945	7,721	12,490	34,032	13,260	33,150	77,910	4.8
SF120XP0	12.000	13.500	12.555	12.945	8,084	13,190	38,666	14,390	35,970	91,730	5.2
SF140XP0	14.000	15.500	14.555	14.945	8,775	14,530	48,556	16,650	41,620	122,800	6.0
SF160XP0	16.000	17.500	16.555	16.945	9,421	15,820	59,200	18,900	47,260	158,300	7.1
SF180XP0	18.000	19.500	18.555	18.945	10,028	17,060	70,537	21,160	52,900	198,400	7.9
SF200XP0	20.000	21.500	20.555	20.945	10,602	18,250	82,528	23,420	58,550	243,000	8.9
SF250XP0	25.000	26.500	25.555	25.945	11,909	21,070	115,037	29,060	72,650	374,200	10.9

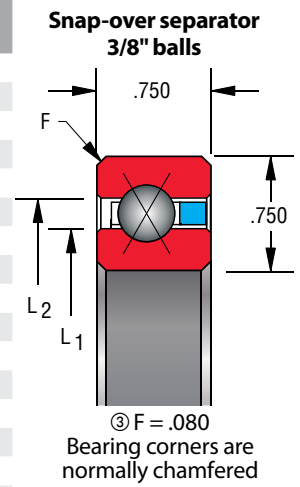

SG Series											
KAYDON Bearing Number	Dimensions in Inches				Capacities ^①						Approx. Wt. in lbs.
	Size		Land Diameters		Dynamic			Static ^②			
	Bore	Outside Dia.	L ₁	L ₂	Radial (lbs)	Thrust (lbs)	Moment (in-lbs)	Radial (lbs)	Thrust (lbs)	Moment (in-lbs)	
SG040XP0	4.000	6.000	4.742	5.258	7,979	11,260	14,966	8,210	20,520	20,520	3.6
SG042XP0	4.250	6.250	4.992	5.508	7,917	11,260	15,592	8,210	20,520	21,550	3.8
SG045XP0	4.500	6.500	5.242	5.758	8,205	11,750	16,930	8,760	21,890	24,080	4.0
SG047XP0	4.750	6.750	5.492	6.008	8,487	12,230	18,306	9,300	23,260	26,740	4.1
SG050XP0	5.000	7.000	5.742	6.258	8,762	12,710	19,721	9,850	24,620	29,550	4.3
SG055XP0	5.500	7.500	6.242	6.758	8,979	13,180	21,896	10,400	25,990	33,790	4.7
SG060XP0	6.000	8.000	6.742	7.258	9,503	14,090	24,956	11,490	28,730	40,220	5.1
SG065XP0	6.500	8.500	7.242	7.758	9,713	14,530	27,327	12,040	30,100	45,140	5.4
SG070XP0	7.000	9.000	7.742	8.258	10,208	15,400	30,636	13,130	32,830	52,530	5.8
SG075XP0	7.500	9.500	8.242	8.758	10,410	15,820	33,196	13,680	34,200	58,140	6.1
SG080XP0	8.000	10.000	8.742	9.258	10,882	16,650	36,743	14,770	36,940	66,480	6.5
SG090XP0	9.000	11.000	9.742	10.258	11,526	17,870	43,240	16,420	41,040	82,080	7.2
SG100XP0	10.000	12.000	10.742	11.258	12,147	19,040	50,124	18,060	45,140	99,320	7.9
SG110XP0	11.000	13.000	11.742	12.258	12,739	20,180	57,347	19,700	49,250	118,200	8.6
SG120XP0	12.000	14.000	12.742	13.258	13,315	21,280	64,935	21,340	53,350	138,700	9.3
SG140XP0	14.000	16.000	14.742	15.258	14,404	23,410	81,056	24,620	61,560	184,700	10.8
SG160XP0	16.000	18.000	16.742	17.258	15,425	25,450	98,373	27,910	69,770	237,200	12.3
SG180XP0	18.000	20.000	18.742	19.258	16,386	27,410	116,793	31,190	77,980	296,300	13.7
SG200XP0	20.000	22.000	20.742	21.258	17,293	29,300	136,238	34,470	86,180	362,000	15.8
SG220XP0	22.000	24.000	22.742	23.258	18,152	31,130	156,625	37,760	94,390	434,200	17.3
SG250XP0	25.000	27.000	25.742	26.258	19,360	33,780	188,838	42,680	106,700	554,900	19.5

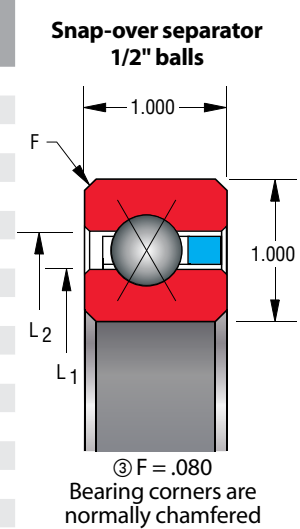

① Capacities listed are not simultaneous. For combined loading see discussion of [Bearing Selection](#) and [Load Analysis](#). Dynamic capacities are based upon 1 million revolutions of L10 life. Published capacities do not apply to hybrid series bearings P, X, and Y - contact Kaydon product engineering for values.

② Static capacities are non-brinell limits based on rigid support from the shaft and housing.

③ "F" is the maximum shaft or housing fillet radius the bearing corners will clear.

Reali-Slim MM Metric Series Bearings

Kaydon created the thin section bearing standard of the industry in 1954 based on inch sizes. The Reali-Slim inch-standard bearing is still the most widely used thin section bearing in the world.

However, for those applications that require metric envelope dimensions or for dimensional interchangeability with other products, Kaydon offers the Reali-Slim MM series of bearings.

These bearings are offered:

- in cross sections of 8, 13, and 20mm
- with bore diameters ranging from 20mm to 360mm
- with many of the same options found on standard Reali-Slim bearings

The Reali-Slim MM series may also be customized for special applications with options such as:

- ceramic balls
- special lubes
- integral seals

Consult Kaydon engineering or your Kaydon representative for details on customization.



Download Reali-Design MM software from our website, www.kaydonbearings.com, to obtain specific load/life and other performance data not shown here.

Reali-Slim MM Bearings Availability

Series	Type	Bore Diameter in Millimeters																							
		25	50	60	70	80	90	100	110	120	130	140	150	160	170	180	190	200	250	300	320	340	360		
8mm Double Sealed	A	Available																							
	C	Available																							
	X	Available																							
8mm Open	A	Available																							
	C	Available																							
	X	Available																							
13mm Open	A	Available																							
	C	Available																							
	X	Available																							
20mm Open	A	Available																							
	C	Available																							
	X	Available																							

Reali-Slim MM Metric Series Bearing Selections

How to identify Reali-Slim MM Bearings using our part number code:

Standard and optional metric Reali-Slim bearings are marked for complete identification with a 9- or 10-digit part number.

Positions 1–9 identify materials, size, type, separator type, and precision. Position 10 (optional) identifies non-standard internal

fit, either preload or clearance. Custom and proprietary bearings cannot be identified by code, and are marked only with a 9-digit number.

Figure 2-8

Position	1	2	3	4	5	6	7	8	9	10
Nomenclature	Material	Bore (mm)			Width (mm)		Type	Separator	Precision	Internal Fit
Example	K	0	8	0	0	8	X	P	0	K

For a complete explanation of position numbers, please refer to [Pages 2-3](#).

Type A – ANGULAR CONTACT

A deep groove bearing with reduced shoulder on one side of inner or outer race ball path. Snap-over assembly permits use of a one-piece circular pocket ring separator and greater ball complement. These bearings will accept radial load and single direction thrust load and are normally used in conjunction with another bearing of similar construction. Type A bearings require

the application of thrust to establish contact angle. Stock bearings are individual units and when purchased as such must be adjusted at installation to desired running clearance or preload. If preferred, matched sets are available. Kaydon also offers matched spacers for applications requiring extra precision. Kaydon can provide this service direct from the factory.

KAYDON Bearing Number	8mm Series					Capacities in Newtons ^①					Approx. Weight (kg)
	Dimensions in Millimeters		Land Diameters			Dynamic			Static ^②		
	Size					KAYDON Radial	ISO Radial ^③	Axial	Radial	Axial	
	Bore	Outside Dia.	L ₁	L ₂	L ₃						
K02508ARO	25	41	30.9	35.1	37.2	2667	5205	5502	3648	10523	0.06
K05008ARO	50	66	55.9	60.1	62.2	3599	6638	8032	6433	18574	0.08
K06008ARO	60	76	65.9	70.1	72.2	4001	7176	9071	7718	22291	0.09
K07008ARO	70	86	75.9	80.1	82.2	4315	7530	9895	8787	25380	0.10
K08008ARO	80	96	85.9	90.1	92.2	4609	7855	10689	9865	28469	0.12
K09008ARO	90	106	95.9	100.1	102.2	4952	8263	11591	11150	32185	0.13
K10008ARO	100	116	105.9	110.1	112.2	5227	8539	12327	12219	35284	0.14
K11008ARO	110	126	115.9	120.1	122.2	5502	8800	13033	13298	38383	0.15
K12008ARO	120	136	125.9	130.1	132.2	5757	9048	13729	14367	41472	0.16
K13008ARO	130	146	135.9	140.1	142.2	6061	9370	14533	15651	45189	0.17
K14008ARO	140	156	145.9	150.1	152.2	6306	9592	15191	16730	48278	0.18
K15008ARO	150	166	155.9	160.1	162.2	6541	9805	15838	17799	51377	0.20
K16008ARO	160	176	165.9	170.1	172.2	6825	10086	16583	19084	55094	0.20
K17008ARO	170	186	175.9	180.1	182.1	7061	10282	17201	20153	58183	0.21
K18008ARO	180	196	185.9	190.1	192.1	7277	10472	17809	21231	61282	0.22
K19008ARO	190	206	195.9	200.1	202.1	7541	10723	18525	22516	64998	0.23
K20008ARO	200	216	205.9	210.1	212.1	7757	10900	19103	23585	68097	0.23
K25008ARO	250	266	255.9	260.1	262.1	8797	11772	22006	29165	84190	0.28
K30008ARO	300	316	305.9	310.1	312.1	9797	12596	24830	34951	100901	0.33
K32008ARO	320	336	325.9	330.1	332.1	10189	12910	25939	37314	107706	0.36
K34008ARO	340	356	345.9	350.1	352.1	10523	13164	26919	39452	113894	0.38
K36008ARO	360	376	365.9	370.1	372.1	10885	13457	27988	41816	120710	0.40

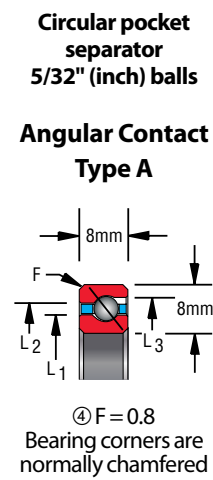

① Capacities listed are not simultaneous. For combined loading see discussion of Bearing Selection and Load Analysis. Dynamic capacities are based upon 1 million revolutions of L10 life. Published capacities do not apply to hybrid series bearings P, X, and Y - contact Kaydon product engineering for values.
 ② Static capacities are non-brinell limits based on rigid support from the shaft and housing.
 ③ ISO Radial ratings are calculated per ISO 281:1990. They are included for comparison only (refer to [Page 95](#)).
 ④ "F" is the maximum shaft or housing fillet radius the bearing corners will clear.

Type A – Real-Slim MM Metric Series Bearing Selections, ANGULAR CONTACT

Section 2 Selection Tables

13mm Series											
KAYDON Bearing Number	Dimensions in Millimeters					Capacities in Newtons ^①					Approx. Weight (kg)
	Size		Land Diameters			Dynamic			Static ^②		
	Bore	Outside Dia.	L ₁	L ₂	L ₃	KAYDON Radial	ISO Radial ^③	Axial	Radial	Axial	
K02513ARO	25	51	34.7	41.3	44.7	5433	9563	10542	6041	17436	0.13
K05013ARO	50	76	59.7	66.3	69.6	7110	12574	15171	10434	30106	0.20
K06013ARO	60	86	69.7	76.3	79.6	7669	13385	16730	12082	34863	0.22
K07013ARO	70	96	79.7	86.3	89.6	8434	14482	18691	14278	41198	0.25
K08013ARO	80	106	89.7	96.3	99.6	8953	15113	20104	15916	45954	0.28
K09013ARO	90	116	99.7	106.3	109.6	9454	15696	21477	17564	50710	0.31
K10013ARO	100	126	109.7	116.3	119.6	9934	16240	22791	19211	55466	0.34
K11013ARO	110	136	119.7	126.3	129.6	10405	16750	24075	20859	60223	0.37
K12013ARO	120	146	129.7	136.3	139.6	10866	17233	25331	22506	64969	0.39
K13013ARO	130	156	139.7	146.3	149.6	11484	17959	26949	24703	71314	0.42
K14013ARO	140	166	149.7	156.3	159.5	11915	18386	28135	26350	76070	0.45
K15013ARO	150	176	159.7	166.3	169.5	12337	18795	29292	27998	80817	0.48
K16013ARO	160	186	169.7	176.3	179.5	12758	19189	30440	29646	85573	0.51
K17013ARO	170	196	179.7	186.3	189.5	13161	19568	31548	31293	90329	0.54
K18013ARO	180	206	189.7	196.3	199.5	13553	19935	32646	32941	95085	0.56
K19013ARO	190	216	199.7	206.3	209.5	13945	20289	33725	34588	99842	0.59
K20013ARO	200	226	209.7	216.3	219.4	14475	20841	35137	36775	106177	0.62
K25013ARO	250	276	259.7	266.3	269.4	16269	22401	40207	45013	129948	0.76
K30013ARO	300	326	309.7	316.3	319.3	18044	23952	45287	53799	155308	0.90
K32013ARO	320	346	329.7	336.3	339.3	18672	24463	47111	57094	164811	0.96
K34013ARO	340	366	349.7	356.3	359.2	19398	25107	49200	60929	175902	1.02
K36013ARO	360	386	369.7	376.3	379.2	19986	25579	50955	64234	185414	1.07

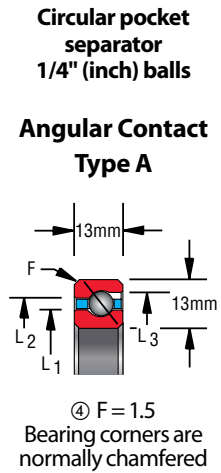

20mm Series											
KAYDON Bearing Number	Dimensions in Millimeters					Capacities in Newtons ^①					Approx. Weight (kg)
	Size		Land Diameters			Dynamic			Static ^②		
	Bore	Outside Dia.	L ₁	L ₂	L ₃	KAYDON Radial	ISO Radial ^③	Axial	Radial	Axial	
K02520ARO	25	65	40.0	50.0	55	11327	17632	20741	11121	32087	0.31
K05020ARO	50	90	65.0	75.0	80	14318	23688	29155	18525	53485	0.49
K06020ARO	60	100	75.0	85.0	90	15171	25112	31685	20996	60615	0.56
K07020ARO	70	110	85.0	95.0	100	16014	26377	34127	23467	67744	0.62
K08020ARO	80	120	95.0	105.0	110	16838	27523	36481	25939	74874	0.69
K09020ARO	90	130	105.0	115.0	120	18152	29396	39884	29646	85573	0.77
K10020ARO	100	140	115.0	125.0	130	18917	30333	42071	32117	92702	0.84
K11020ARO	110	150	125.0	135.0	140	19662	31212	44199	34588	99842	0.91
K12020ARO	120	160	135.0	145.0	150	20398	32042	46278	37050	106971	0.97
K13020ARO	130	170	145.0	155.0	160	21124	32831	48317	39521	114100	1.04
K14020ARO	140	180	155.0	165.0	170	21830	33583	50308	41992	121230	1.11
K15020ARO	150	190	165.0	175.0	180	22938	34936	53221	45699	131929	1.19
K16020ARO	160	200	175.0	185.0	190	23605	35607	55123	48170	139058	1.26
K17020ARO	170	210	185.0	195.0	200	24262	36255	56986	50465	146188	1.32
K18020ARO	180	220	195.0	205.0	210	24909	36881	58830	53113	153317	1.39
K19020ARO	190	230	205.0	215.0	220	25546	37488	60635	55584	160447	1.46
K20020ARO	200	240	215.0	225.0	230	26537	38615	63302	59281	171146	1.54
K25020ARO	250	290	265.0	275.0	280	29822	41745	72648	72873	210372	1.89
K30020ARO	300	340	315.0	325.0	330	32529	44076	80630	85230	246029	2.23
K32020ARO	320	360	335.0	345.0	350	33872	45360	84484	91408	263858	2.37
K34020ARO	340	380	355.0	365.0	370	34872	46191	87505	96341	278117	2.51
K36020ARO	360	400	375.0	385.0	390	36138	47377	91202	102519	295945	2.66

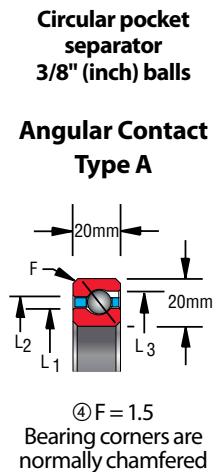

① Capacities listed are not simultaneous. For combined loading see discussion of Bearing Selection and Load Analysis. Dynamic capacities are based upon 1 million revolutions of L10 life. Published capacities do not apply to hybrid series bearings P, X, and Y - contact Kaydon product engineering for values.

② Static capacities are non-brinell limits based on rigid support from the shaft and housing.

③ ISO Radial ratings are calculated per ISO 281:1990. They are included for comparison only (refer to Page 95).

④ "F" is the maximum shaft or housing fillet radius the bearing corners will clear.

Reali-Slim MM Metric Series Bearing Selections

Type C – RADIAL CONTACT

A Conrad assembled bearing designed primarily for application of radial load—deep ball grooves also permit application of

thrust load in either direction – often used in conjunction with another bearing.

8mm Series								
KAYDON Bearing Number	Dimensions in Millimeters				Capacities in Newtons ^①			Approx. Wt. in (kg)
	Size		Land Diameters		Dynamic		Static ^②	
	Bore	Outside Dia.	L ₁	L ₂	KAYDON Radial	ISO Radial ^③	Radial	
K02508CPO	25	41	30.9	35.1	2501	4686	2971	0.06
K05008CPO	50	66	55.9	60.1	3432	6200	5452	0.08
K06008CPO	60	76	65.9	70.1	3766	6645	6433	0.09
K07008CPO	70	86	75.9	80.1	4089	7041	7433	0.10
K08008CPO	80	96	85.9	90.1	4393	7399	8424	0.11
K09008CPO	90	106	95.9	100.1	4688	7728	9405	0.13
K10008CPO	100	116	105.9	110.1	4972	8034	10405	0.14
K11008CPO	110	126	115.9	120.1	5237	8319	11395	0.15
K12008CPO	120	136	125.9	130.1	5502	8588	12376	0.16
K13008CPO	130	146	135.9	140.1	5766	8843	13376	0.17
K14008CPO	140	156	145.9	150.1	6011	9085	14367	0.18
K15008CPO	150	166	155.9	160.1	6257	9317	15347	0.20
K16008CPO	160	176	165.9	170.1	6492	9538	16338	0.20
K17008CPO	170	186	175.9	180.1	6727	9751	17328	0.20
K18008CPO	180	196	185.9	190.1	6953	9956	18319	0.21
K19008CPO	190	206	195.9	200.1	7110	10067	19064	0.21
K20008CPO	200	216	205.9	210.1	7335	10261	20055	0.22
K25008CPO	250	266	255.9	260.1	8365	11146	25007	0.28
K30008CPO	300	316	305.9	310.1	9307	11924	29959	0.35
K32008CPO	320	336	325.9	330.1	9660	12211	31940	0.39
K34008CPO	340	356	345.9	350.1	9964	12427	33921	0.42
K36008CPO	360	376	365.9	370.1	10297	12695	35657	0.46

Snap-over separator
5/32" (inch) balls

Conrad Assembly
Type C

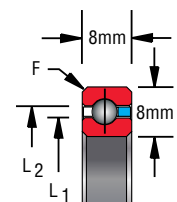

⑤ F = 0.8
Bearing corners are normally chamfered

8mm Series (Double Sealed)										
KAYDON Bearing Number	Dimensions in Millimeters				Capacities in Newtons ^①			Limiting Speeds (RPM*)	Torque Max. No Load (N-m) ^④	Approx. Wt. in (kg)
	Size		Land Diameters		Dynamic		Static ^②			
	Bore	Outside Dia.	L ₁	L ₂	KAYDON Radial	ISO Radial ^③	Radial			
J02508CPO	25	41	31.55	34.42	2501	4686	2971	5580	0.02	0.06
J05008CPO	50	66	56.55	59.42	3432	6200	5452	3180	0.04	0.08
J06008CPO	60	76	66.55	69.42	3766	6645	6433	2710	0.05	0.09
J07008CPO	70	86	76.55	79.42	4089	7041	7433	2360	0.07	0.10
J08008CPO	80	96	86.55	89.42	4393	7399	8424	2090	0.09	0.11
J09008CPO	90	106	96.55	99.42	4688	7728	9405	1880	0.12	0.13
J10008CPO	100	116	106.55	109.42	4972	8034	10405	1700	0.15	0.14
J11008CPO	110	126	116.55	119.42	5237	8319	11395	1560	0.18	0.15
J12008CPO	120	136	126.55	129.42	5502	8588	12376	1440	0.22	0.16
J13008CPO	130	146	136.55	139.42	5766	8843	13376	1330	0.26	0.17
J14008CPO	140	156	146.55	149.42	6011	9085	14367	1240	0.30	0.18
J15008CPO	150	166	156.55	159.42	6257	9317	15347	1160	0.35	0.20
J16008CPO	160	176	166.55	169.42	6492	9538	16338	1090	0.40	0.20
J17008CPO	170	186	176.55	179.42	6727	9751	17328	1030	0.46	0.20

Snap-over separator
5/32" (inch) balls

Conrad Assembly
Type C

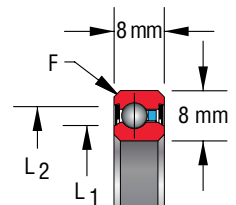

⑤ F = 0.8
Bearing corners are normally chamfered

① Capacities listed are not simultaneous. For combined loading see discussion of [Bearing Selection](#) and [Load Analysis](#). Dynamic capacities are based upon 1 million revolutions of L10 life. Published capacities do not apply to hybrid series bearings P, X, and Y - contact Kaydon product engineering for values.

② Static capacities are non-brinell limits based on rigid support from the shaft and housing.

③ ISO Radial ratings are calculated per ISO 281:1990. They are included for comparison only (refer to [Page 95](#)).

④ Torque figures shown are for single bearings with standard internal fit-up, standard lubricant at room temperature, and under 5 pounds thrust load.

⑤ "F" is the maximum shaft or housing fillet radius the bearing corners will clear.

*Values apply to bearings loaded up to 20% of their dynamic capacity.

Type C – Reali-Slim MM Metric Series Bearing Selections, RADIAL CONTACT

Selection Tables

Section 2

13mm Series								
KAYDON Bearing Number	Dimensions in Millimeters				Capacities in Newtons ^①			Approx. Wt. in (kg)
	Size		Land Diameters		Dynamic		Static ^②	
	Bore	Outside Dia.	L ₁	L ₂	KAYDON Radial	ISO Radial ^③		
K02513CP0	25	51	34.7	41.3	5247	8660	5070	0.11
K05013CP0	50	76	59.7	66.3	6835	11706	8875	0.18
K06013CP0	60	86	69.7	76.3	7600	12902	10778	0.21
K07013CP0	70	96	79.7	86.3	8032	13476	12043	0.24
K08013CP0	80	106	89.7	96.3	8453	13999	13317	0.26
K09013CP0	90	116	99.7	106.3	9130	14898	15210	0.29
K10013CP0	100	126	109.7	116.3	9522	15328	16485	0.32
K11013CP0	110	136	119.7	126.3	10150	16106	18387	0.35
K12013CP0	120	146	129.7	136.3	10523	16476	19653	0.38
K13013CP0	130	156	139.7	146.3	10885	16829	20918	0.41
K14013CP0	140	166	149.7	156.3	11464	17494	22820	0.44
K15013CP0	150	176	159.7	166.3	11807	17810	24085	0.46
K16013CP0	160	186	169.7	176.3	12150	18116	25360	0.49
K17013CP0	170	196	179.7	186.3	12690	18703	27262	0.52
K18013CP0	180	206	189.7	196.3	13013	18982	28528	0.55
K19013CP0	190	216	199.7	206.3	13337	19254	29793	0.58
K20013CP0	200	226	209.7	216.3	13837	19784	31695	0.61
K25013CP0	250	276	259.7	266.3	15671	21458	39305	0.75
K30013CP0	300	326	309.7	316.3	17201	22721	46278	0.89
K32013CP0	320	346	329.7	336.3	17878	23312	49445	0.95
K34013CP0	340	366	349.7	356.3	18525	23879	52613	1.01
K36013CP0	360	386	369.7	376.3	19162	24424	55780	1.06

Snap-over separator
1/4" (inch) balls

Conrad Assembly
Type C

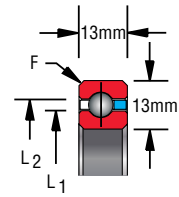

④ F = 1.5
Bearing corners are normally chamfered

20mm Series								
KAYDON Bearing Number	Dimensions in Millimeters				Capacities in Newtons ^①			Approx. Wt. in (kg)
	Size		Land Diameters		Dynamic		Static ^②	
	Bore	Outside Dia.	L ₁	L ₂	KAYDON Radial	ISO Radial ^③		
K02520CP0	25	65	40.0	50.0	11552	16436	9983	0.34
K05020CP0	50	90	65.0	75.0	13827	21778	15691	0.51
K06020CP0	60	100	75.0	85.0	14239	22616	17113	0.58
K07020CP0	70	110	85.0	95.0	15426	24527	19966	0.65
K08020CP0	80	120	95.0	105.0	15857	25129	21388	0.72
K09020CP0	90	130	105.0	115.0	16966	26740	24252	0.80
K10020CP0	100	140	115.0	125.0	17387	27213	25674	0.86
K11020CP0	110	150	125.0	135.0	18437	28623	28528	0.94
K12020CP0	120	160	135.0	145.0	19437	29931	31381	1.01
K13020CP0	130	170	145.0	155.0	19839	30282	32803	1.08
K14020CP0	140	180	155.0	165.0	20800	31468	35657	1.15
K15020CP0	150	190	165.0	175.0	21192	31776	37079	1.20
K16020CP0	160	200	175.0	185.0	22104	32867	39933	1.30
K17020CP0	170	210	185.0	195.0	22487	33145	42786	1.40
K18020CP0	180	220	195.0	205.0	23369	34159	44208	1.50
K19020CP0	190	230	205.0	215.0	24222	35126	47072	1.50
K20020CP0	200	240	215.0	225.0	24585	35363	48494	1.60
K25020CP0	250	290	265.0	275.0	27665	38384	59899	2.10
K30020CP0	300	340	315.0	325.0	30508	41029	71314	2.30
K32020CP0	320	360	335.0	345.0	31509	41900	75590	2.42
K34020CP0	340	380	355.0	365.0	32480	42740	79865	2.54
K36020CP0	360	400	375.0	385.0	33421	43552	84151	2.70

Snap-over separator
3/8" (inch) balls

Conrad Assembly
Type C

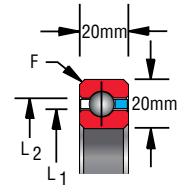

④ F = 1.5
Bearing corners are normally chamfered

① Capacities listed are not simultaneous. For combined loading see discussion of Bearing Selection and Load Analysis. Dynamic capacities are based upon 1 million revolutions of L10 life. Published capacities do not apply to hybrid series bearings P, X, and Y - contact Kaydon product engineering for values.

② Static capacities are non-brinell limits based on rigid support from the shaft and housing.

③ ISO Radial ratings are calculated per ISO 281:1990. They are included for comparison only (refer to Page 95).

④ "F" is the maximum shaft or housing fillet radius the bearing corners will clear.

Reali-Slim MM Metric Series Bearing Selections, Type X – FOUR-POINT CONTACT

A Conrad assembled bearing designed for applications involving multiple loads. Unique internal geometry permits application of radial load, thrust load in either direction, and moment load,

individually or in any combination. A single four-point contact bearing may replace two bearings in many applications.

8mm Series											
KAYDON Bearing Number	Dimensions in Millimeters				Capacities ^①						Approx. Weight (kg)
	Size		Land Diameters		Dynamic			Static ^②			
	Bore	Outside Dia.	L ₁	L ₂	Radial (N)	Thrust (N)	Moment (N-m)	Radial (N)	Thrust (N)	Moment (N-m)	
K02508XP0	25	41	30.9	35.1	3246	4599	40	3275	7433	49	0.06
K05008XP0	50	66	55.9	60.1	4511	6531	98	5443	13621	158	0.08
K06008XP0	60	76	65.9	70.1	4962	7306	127	6433	16093	219	0.09
K07008XP0	70	86	75.9	80.1	5384	8032	158	7424	18574	290	0.10
K08008XP0	80	96	85.9	90.1	5796	8728	191	8424	21045	370	0.11
K09008XP0	90	106	95.9	100.1	6188	9405	228	9405	23526	461	0.13
K10008XP0	100	116	105.9	110.1	6570	10052	266	10395	25997	562	0.14
K11008XP0	110	126	115.9	120.1	6933	10689	307	11395	28469	672	0.15
K12008XP0	120	136	125.9	130.1	7286	11297	350	12376	30950	792	0.16
K13008XP0	130	146	135.9	140.1	7630	11886	395	13366	33431	923	0.18
K14008XP0	140	156	145.9	150.1	7963	12464	442	14367	35902	1063	0.19
K15008XP0	150	166	155.9	160.1	8296	13033	492	15347	38383	1213	0.20
K16008XP0	160	176	165.9	170.1	8610	13592	543	16338	40855	1373	0.20
K17008XP0	170	186	175.9	180.1	8924	14131	596	17328	43326	1543	0.20
K18008XP0	180	196	185.9	190.1	9228	14661	651	18319	45807	1722	0.21
K19008XP0	190	206	195.9	200.1	9444	15063	701	19064	47660	1888	0.21
K20008XP0	200	216	205.9	210.1	9728	15573	759	20055	50141	2086	0.22
K25008XP0	250	266	255.9	260.1	11111	18044	1075	25007	62517	3226	0.28
K30008XP0	300	316	305.9	310.1	12366	20359	1429	29959	74903	4614	0.35
K32008XP0	320	336	325.9	330.1	12847	21241	1580	31940	79856	5238	0.39
K34008XP0	340	356	345.9	350.1	13239	22114	1728	33921	84808	5859	0.42
K36008XP0	360	376	365.9	370.1	13690	22849	1890	35657	89133	6561	0.46

Snap-over separator
5/32" (inch) balls

4 Point Contact
Type X

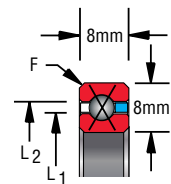

④ F = 0.8
Bearing corners are normally chamfered

8mm Series (Double Sealed)													
KAYDON Bearing Number	Dimensions in Millimeters				Capacities ^①						Limiting Speeds (RPM*)	Torque Max. No Load (N-m) ^③	Approx. Wt. in (kg)
	Size		Land Diameters		Dynamic			Static ^②					
	Bore	Outside Dia.	L ₁	L ₂	Radial (N)	Thrust (N)	Moment (N-m)	Radial (N)	Thrust (N)	Moment (N-m)			
J02508XP0	25	41	31.55	34.42	3246	4599	40	3275	7433	49	3000	0.02	0.06
J05008XP0	50	66	56.55	59.42	4511	6531	98	5443	13621	158	1500	0.04	0.08
J06008XP0	60	76	66.55	69.42	4962	7306	127	6433	16093	219	1270	0.05	0.09
J07008XP0	70	86	76.55	79.42	5384	8032	158	7424	18574	290	1090	0.07	0.10
J08008XP0	80	96	86.55	89.42	5796	8728	191	8424	21045	370	950	0.09	0.11
J09008XP0	90	106	96.55	99.42	6188	9405	228	9405	23526	461	700	0.12	0.13
J10008XP0	100	116	106.55	109.42	6570	10052	266	10395	25997	562	630	0.15	0.14
J11008XP0	110	126	116.55	119.42	6933	10689	307	11395	28469	672	580	0.18	0.15
J12008XP0	120	136	126.55	129.42	7286	11297	350	12376	30950	792	530	0.22	0.16
J13008XP0	130	146	136.55	139.42	7630	11886	395	13366	33431	923	490	0.26	0.18
J14008XP0	140	156	146.55	149.42	7963	12464	442	14367	35902	1063	450	0.30	0.19
J15008XP0	150	166	156.55	159.42	8296	13033	492	15347	38383	1213	420	0.35	0.20
J16008XP0	160	176	166.55	169.42	8610	13592	543	16338	40855	1373	400	0.40	0.20
J17008XP0	170	186	176.55	179.42	8924	14131	596	17328	43326	1543	370	0.46	0.20

Snap-over separator
5/32" (inch) balls

4 Point Contact
Type X

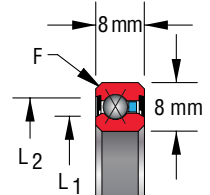

④ F = 0.8
Bearing corners are normally chamfered

① Capacities listed are not simultaneous. For combined loading see discussion of Bearing Selection and Load Analysis. Dynamic capacities are based upon 1 million revolutions of L10 life. Published capacities do not apply to hybrid series bearings P, X, and Y - contact Kaydon product engineering for values.

② Static capacities are non-brinell limits based on rigid support from the shaft and housing.

③ Torque figures shown are for single bearings with standard internal fit-up, standard lubricant at room temperature, and under 5 pounds thrust load.

④ "F" is the maximum shaft or housing fillet radius the bearing corners will clear.

*Values apply to bearings loaded up to 20% of their dynamic capacity.

Type X – Reali-Slim MM Metric Series Bearing Selections, FOUR-POINT CONTACT

Selection Tables
Section 2

13mm Series											
KAYDON Bearing Number	Dimensions in Millimeters				Capacities ^①						Approx. Weight (kg)
	Size		Land Diameters		Dynamic			Static ^②			
	Bore	Outside Dia.	L ₁	L ₂	Radial (N)	Thrust (N)	Moment (N-m)	Radial (N)	Thrust (N)	Moment (N-m)	
K02513XP0	25	51	34.7	41.3	6757	8522	96	6825	12680	96	0.13
K05013XP0	50	76	59.7	66.3	8924	12023	211	9012	22192	280	0.20
K06013XP0	60	86	69.7	76.3	9944	14082	272	10778	26939	393	0.23
K07013XP0	70	96	79.7	86.3	10532	15171	328	12043	30106	500	0.26
K08013XP0	80	106	89.7	96.3	11111	16210	388	13317	33274	619	0.28
K09013XP0	90	116	99.7	106.3	12003	17730	464	15210	38030	784	0.31
K10013XP0	100	126	109.7	116.3	12543	18691	532	16485	41198	931	0.34
K11013XP0	110	136	119.7	126.3	13376	20104	617	18387	45954	1131	0.37
K12013XP0	120	146	129.7	136.3	13876	21025	693	19672	49131	1307	0.40
K13013XP0	130	156	139.7	146.3	14377	21918	771	20918	52299	1496	0.43
K14013XP0	140	166	149.7	156.3	15141	23222	869	22820	57045	1746	0.46
K15013XP0	150	176	159.7	166.3	15612	24075	954	24085	60223	1963	0.48
K16013XP0	160	186	169.7	176.3	16073	24919	1043	25360	63390	2193	0.51
K17013XP0	170	196	179.7	186.3	16779	26145	1152	27262	68146	2494	0.54
K18013XP0	180	206	189.7	196.3	17220	26949	1247	28528	71314	2753	0.57
K19013XP0	190	216	199.7	206.3	17652	27743	1344	29793	74482	3024	0.60
K20013XP0	200	226	209.7	216.3	18319	28910	1464	31695	79238	3375	0.63
K25013XP0	250	276	259.7	266.3	20780	33372	2050	39305	98253	5168	0.77
K30013XP0	300	326	309.7	316.3	22820	37206	2680	46278	115679	7242	0.91
K32013XP0	320	346	329.7	336.3	23722	38893	2963	49445	123613	8232	0.97
K34013XP0	340	366	349.7	356.3	24595	40531	3257	52613	131527	9286	1.02
K36013XP0	360	386	369.7	376.3	25438	42149	3560	55780	139451	10403	1.08

Snap-over separator
1/4" (inch) balls

4 Point Contact
Type X

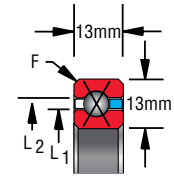

③ F = 1.5
Bearing corners are normally chamfered

20mm Series											
KAYDON Bearing Number	Dimensions in Millimeters				Capacities ^①						Approx. Weight (kg)
	Size		Land Diameters		Dynamic			Static ^②			
	Bore	Outside Dia.	L ₁	L ₂	Radial (N)	Thrust (N)	Moment (N-m)	Radial (N)	Thrust (N)	Moment (N-m)	
K02520XP0	25	65	40.0	50.0	14739	17544	225	14886	24958	225	0.34
K05020XP0	50	90	65.0	75.0	17917	23712	470	18093	39217	549	0.52
K06020XP0	60	100	75.0	85.0	18505	25125	556	18691	42786	685	0.59
K07020XP0	70	110	85.0	95.0	20104	27841	679	20310	49916	899	0.66
K08020XP0	80	120	95.0	105.0	20702	29155	777	21388	53485	1070	0.73
K09020XP0	90	130	105.0	115.0	22192	31685	916	24252	60615	1334	0.80
K10020XP0	100	140	115.0	125.0	22781	32921	1026	25674	64185	1540	0.87
K11020XP0	110	150	125.0	135.0	24183	35314	1179	28528	71314	1854	0.94
K12020XP0	120	160	135.0	145.0	25527	37628	1341	31381	78443	2196	1.01
K13020XP0	130	170	145.0	155.0	26086	38766	1468	32803	82013	2460	1.07
K14020XP0	140	180	155.0	165.0	27370	40982	1643	35657	89142	2852	1.15
K15020XP0	150	190	165.0	175.0	27900	42071	1779	37079	92702	3152	1.22
K16020XP0	160	200	175.0	185.0	29126	44199	1967	39933	99832	3594	1.30
K17020XP0	170	210	185.0	195.0	29646	46278	2113	42786	106961	3929	1.37
K18020XP0	180	220	195.0	205.0	30822	47297	2312	44208	110531	4421	1.44
K19020XP0	190	230	205.0	215.0	31970	49318	2519	47072	117670	4942	1.51
K20020XP0	200	240	215.0	225.0	32450	50308	2678	48494	121230	5334	1.57
K25020XP0	250	290	265.0	275.0	36589	57918	3706	59899	149757	8087	2.10
K30020XP0	300	340	315.0	325.0	40394	65048	4849	71314	178275	11410	2.30
K32020XP0	320	360	335.0	345.0	41727	67636	5323	75590	188974	12850	2.44
K34020XP0	340	380	355.0	365.0	43032	70157	5812	79865	199673	14376	2.58
K36020XP0	360	400	375.0	385.0	44306	72648	6316	84151	210372	15988	2.73

Snap-over separator
3/8" (inch) balls

4 Point Contact
Type X

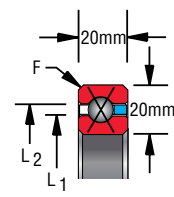

③ F = 1.5
Bearing corners are normally chamfered

① Capacities listed are not simultaneous. For combined loading see discussion of [Bearing Selection](#) and [Load Analysis](#). Dynamic capacities are based upon 1 million revolutions of L10 life. Published capacities do not apply to hybrid series bearings P, X, and Y - contact Kaydon product engineering for values.
 ② Static capacities are non-brinell limits based on rigid support from the shaft and housing.
 ③ "F" is the maximum shaft or housing fillet radius the bearing corners will clear.

Precision Tolerances & Recommended Fits for Reali-Slim MM Metric Series Bearings

All dimensions in millimeters

Kaydon Class 1 for Type A, C & X Bearings

Bearing Size (mm Series)	Bearing Diameters		Radial & Axial Runout		Rotating Shaft or Duplex DF Mounting		Stationary Shaft or Duplex DB Mounting			Bearing Diametral Clearance* Before Installation		
	Bearing Bore Nominal +.0000	Bearing O.D. Nominal +.0000	Inner Race	Outer Race	Shaft Diameter Nominal -.0000	Housing Bore Nominal -.0000	Shaft Diameter Nominal	Housing Bore Nominal				
020	-.010	-.010	.008	.010	+.010	+.010	-.010	-.020	-.010	-.020	0.025	0.038
025	-.010	-.010	.008	.010	+.010	+.010	-.010	-.020	-.010	-.020	0.025	0.038
050	-.012	-.013	.013	.013	+.012	+.013	-.012	-.024	-.013	-.026	0.030	0.056
060	-.015	-.013	.013	.013	+.015	+.013	-.015	-.030	-.015	-.030	0.030	0.056
070	-.015	-.015	.015	.015	+.015	+.015	-.015	-.030	-.015	-.030	0.030	0.056
080	-.015	-.015	.015	.015	+.015	+.015	-.015	-.030	-.015	-.030	0.030	0.056
090	-.020	-.015	.015	.015	+.020	+.015	-.020	-.040	-.020	-.040	0.041	0.066
100	-.020	-.015	.015	.015	+.020	+.015	-.020	-.040	-.020	-.040	0.041	0.066
110	-.020	-.018	.015	.020	+.020	+.018	-.020	-.040	-.020	-.040	0.041	0.066
120	-.020	-.018	.020	.020	+.020	+.018	-.020	-.036	-.020	-.036	0.041	0.066
130	-.025	-.018	.025	.025	+.025	+.018	-.025	-.051	-.018	-.036	0.051	0.076
140	-.025	-.025	.025	.025	+.025	+.025	-.025	-.051	-.025	-.051	0.051	0.076
150	-.025	-.025	.025	.025	+.025	+.025	-.025	-.051	-.025	-.051	0.051	0.076
160	-.025	-.025	.025	.025	+.025	+.025	-.025	-.051	-.025	-.051	0.051	0.076
170	-.025	-.025	.025	.025	+.025	+.025	-.025	-.051	-.025	-.051	0.051	0.076
180	-.025	-.030	.025	.025	+.025	+.030	-.025	-.051	-.030	-.061	0.051	0.076
190	-.025	-.030	.025	.025	+.025	+.030	-.025	-.051	-.030	-.061	0.051	0.076
200	-.030	-.030	.030	.030	+.030	+.030	-.030	-.061	-.030	-.061	0.061	0.086
250	-.036	-.036	.046	.051	+.036	+.036	-.036	-.071	-.036	-.071	0.071	0.100
300	-.036	-.036	.046	.051	+.036	+.036	-.036	-.071	-.036	-.071	0.071	0.100
320	-.036	-.036	.046	.051	+.036	+.036	-.036	-.071	-.036	-.071	0.071	0.100
340	-.036	-.036	.046	.051	+.036	+.036	-.036	-.071	-.036	-.071	0.071	0.100
360	-.036	-.036	.046	.051	+.036	+.036	-.036	-.071	-.036	-.071	0.071	0.100

* Diametral clearance after installation theoretically can range rather widely if all contributing bearing, housing, and shaft tolerances are at either of their extremes. Diametral clearances shown do not apply to Type A (angular contact) bearings.

Listed shaft and housing diameters are for steel supports with standard bearing diametral clearance. Recommended shaft and housing diameters can change greatly based on orientation, temperature, speed, non-standard diametral clearances, and desired performance characteristics. Contact Kaydon for design assistance when required.

Total Width Tolerance—Duplexed Type A Bearings:
 Up thru 300 mm Bearing Bore +.000 –.254
 Over 300 mm Bearing Bore +.000 –.508
 Race Width Tolerance—Single Type C, X, A Bearings:
 Up thru 300 mm Bearing Bore +.000 –.127
 Over 300 mm Bearing Bore +.000 –.254

Metric Series Ball Bearings (BB Series)

Drop-in Replacements for Cross-Roller Bearings



Kaydon BB Metric Series four-point contact ball bearings are dimensionally interchangeable with cross-roller bearings.

BB Series Bearings Are Available to Match the Bores and Widths of Common Cross-Roller Bearings.

When factors such as cost, availability, corrosion resistance, tighter tolerances, torque, seal/shield options, and temperature resistance are important in your application, it pays to consider BB Series four-point contact metric ball bearings as an alternative to cross-roller bearings. The additional design flexibility they offer can often help you achieve your design objectives with optimum performance and economy.

Additional features not commonly available in standard cross-roller bearings include a protective package for corrosion resistance, custom sealing for extreme environments, application-specific lubrication and temperature capability.

Optimize Your Design Options

With additional features not commonly available in standard cross-roller bearings, BB Series bearings provide greater design flexibility.

Endurakote Plating—For applications requiring superior corrosion resistance we offer our proprietary Endurakote plating. This thin, dense chrome plating gives AISI 52100 bearing material corrosion resistance equal to or better than that of AISI 440C stainless steel. Unlike many traditional chrome platings, the extremely hard surface of Endurakote plating doesn't peel and flake from the bearing race under stress, so corrosion resistance is retained and surface wear is minimized. The performance of Endurakote plating has been proven in critical military, aerospace, and deep space applications.

Seals/Shields—Standard industry seals are generally available from nitrile rubber. Kaydon can also provide custom seals manufactured from silicone or Viton® materials for applications where high temperature or extreme environments are likely to be encountered.

Temperature Capability—Standard cross-roller bearings have a maximum full capacity operating temperature of only 212°F. In contrast, Kaydon bearings can operate at higher temperatures due to our heat treating procedures.

Lubrication Options—Kaydon offers a full range of lubricants, allowing you to optimize bearing performance in a range of applications with special requirements for moisture resistance, hot or cold temperatures, vacuum, and low torque.

Separators—The common roller spacer for many cross-roller bearings is a non-metallic composite. High temperature and/or horizontal axis applications, however, require non-standard materials or a non-standard separator design. Kaydon four-point contact ball bearings are available with separator options to meet a wide range of applications.

Internal Fitup—Kaydon can help you optimize internal fitup of our BB Series four-point contact ball bearings to provide the desired operating performance. Pre-loaded bearings are recommended for greater stiffness, and diametral clearance is recommended for lower torque applications.

Metric Series Ball Bearings - BB Series (continued)

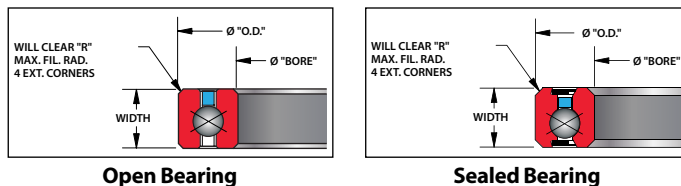

All dimensions in millimeters

(Reali-Slim replacements for RB Series standard cross-roller bearings)

Model Number	KAYDON Part No.	Approx. Weight (kg)	Bore (nominal +0)	O.D. (nominal +0)	Width (nominal +0)	"R"	Dynamic Capacity		
							Radial (N)	Axial (N)	Moment (N-m)
BB3010	39318001	0.1	30-0.01	55-0.013	10-0.12	1	4874	6619	78
BB3510	39319001	0.11	35-0.012	60-0.013	10-0.12	1	5031	6953	90
BB4010	39320001	0.12	40-0.012	65-0.013	10-0.12	1	5423	7610	107
BB4510	39321001	0.13	45-0.012	70-0.013	10-0.12	1	5796	8228	125
BB5013	39322001	0.24	50-0.012	80-0.013	13-0.12	1	9297	12955	227
BB6013	39323001	0.3	60-0.015	90-0.013	13-0.12	1	9905	14082	279
BB7013	39324001	0.31	70-0.015	100-0.015	13-0.12	1	10866	15700	346
BB8016	39325001	0.62	80-0.015	120-0.015	16-0.12	1	16465	23703	618
BB9016	39326001	0.73	90-0.02	130-0.015	16-0.12	1.5	17387	25340	718
BB10020	39327001	1.21	100-0.02	150-0.015	20-0.12	1.5	23487	34127	1102
BB11015	39328001	0.66	110-0.02	145-0.018	15-0.12	1	13631	20565	652
BB11020	39329001	1.36	110-0.02	160-0.02	20-0.12	1.5	24752	36481	1300
BB12025	39330001	2.13	120-0.02	180-0.02	25-0.12	2	39040	56339	2197
BB13025	39331001	2.27	130-0.025	190-0.025	25-0.12	2	40188	58526	2412
BB14025	39332001	2.5	140-0.025	200-0.025	25-0.12	2	42747	62782	2726
BB15013	39333001	0.61	150-0.025	180-0.025	13-0.12	1	15593	24075	965
BB15025	39334001	2.72	150-0.025	210-0.025	25-0.12	2	43816	64861	2959
BB15030	39335001	4.54	150-0.025	230-0.025	30-0.12	2	62792	91447	4475
BB20025	39336001	3.4	200-0.03	260-0.03	25-0.12	2.5	50220	76688	4333
BB20030	39337001	5.72	200-0.03	280-0.03	30-0.12	2.5	71471	107677	6435
BB20035	39338001	8.17	200-0.03	295-0.03	35-0.12	2.5	91859	136518	8529
BB25025	39339001	4.09	250-0.03	310-0.035	25-0.12	3	56074	87662	5891
BB25030	39340001	7.04	250-0.03	330-0.035	30-0.12	3	79434	122769	8641
BB25040	39341001	9.08	250-0.03	355-0.035	40-0.12	3	101244	155063	11489
BB30025	39342001	4.99	300-0.035	360-0.035	25-0.12	3	60438	96311	7482
BB30035	39343001	11.8	300-0.035	395-0.035	35-0.12	3	110452	172548	14399
BB30040	39344001	15.44	300-0.035	405-0.035	40-0.12	3	110227	172548	14576
BB40035	39345001	12.03	400-0.04	480-0.04	35-0.25	3.5	124554	201213	20560
BB40040	39346001	20.66	400-0.04	510-0.04	40-0.25	3.5	126388	205145	21572
BB50040	39347001	22.7	500-0.045	600-0.045	40-0.25	3.5	141029	235320	29099
BB50050	39348001	38.05	500-0.045	625-0.045	50-0.25	3.5	142736	238959	30120
BB60040	39349001	27.24	600-0.045	700-0.045	40-0.2	4	154053	263671	37565
BB70045	39350001	44.95	700-0.045	815-0.045	45-0.25	4	165605	290610	47062
BB80070	39351001	98.52	800-0.05	950-0.05	70-0.25	5	263269	468748	86420
BB90070	39352001	109.87	900-0.05	1050-0.05	70-0.25	5	277597	504827	101535

Note 1: Capacities listed are not simultaneous. For combined loading see discussion of [Bearing Selection](#) and [Load Analysis](#). Dynamic capacities are based upon 1 million revolutions of L₁₀ life. Published capacities do not apply to hybrid series bearings P, X, and Y - contact Kaydon product engineering for values.

Note 2: Standard bearings are supplied without seals and shields, and they are assembled with a light clearance. Alternate features can be obtained by adding the following suffix letter to the basic part number.

- U = single seal CO = standard clearance CCO = preload TT = double shield
- UU = double seal CI = greater than standard clearance T = single shield Check for availability.

Metric Series Ball Bearings - BB Series (continued)

All dimensions in millimeters

Model Number	Bore (nominal +0)	O.D. (nominal +0)	Width (nominal +0)	Standard Diametral Clearance	Radial and Axial Runout	
					Inner	Outer
BB3010	30 -0.01	55 -0.013	10 -0.12	0.025-0.038	0.010	0.010
BB3510	35 -0.012	60 -0.013	10 -0.12	0.03-0.043	0.010	0.010
BB4010	40 -0.012	65 -0.013	10 -0.12	0.03-0.043	0.013	0.013
BB4510	45 -0.012	70 -0.013	10 -0.12	0.03-0.043	0.013	0.013
BB5013	50 -0.012	80 -0.013	13 -0.12	0.03-0.056	0.013	0.013
BB6013	60 -0.015	90 -0.013	13 -0.12	0.03-0.056	0.013	0.013
BB7013	70 -0.015	100 -0.015	13 -0.12	0.03-0.056	0.015	0.015
BB8016	80 -0.015	120 -0.015	16 -0.12	0.03-0.056	0.015	0.015
BB9016	90 -0.02	130 -0.015	16 -0.12	0.041-0.066	0.015	0.015
BB10020	100 -0.02	150 -0.015	20 -0.12	0.041-0.066	0.015	0.015
BB11015	110 -0.02	145 -0.018	15 -0.12	0.041-0.066	0.015	0.020
BB11020	110 -0.02	160 -0.02	20 -0.12	0.041-0.066	0.015	0.020
BB12025	120 -0.02	180 -0.02	25 -0.12	0.05-0.08	0.020	0.020
BB13025	130 -0.025	190 -0.025	25 -0.12	0.05-0.08	0.025	0.025
BB14025	140 -0.025	200 -0.025	25 -0.12	0.05-0.08	0.025	0.025
BB15013	150 -0.025	180 -0.025	13 0.23	0.05-0.08	0.025	0.025
BB15025	150 -0.025	210 -0.025	25 -0.12	0.05-0.08	0.025	0.025
BB15030	150 -0.025	230 -0.025	30 -0.12	0.05-0.08	0.025	0.025
BB20025	200 -0.03	260 -0.03	25 -0.12	0.06-0.09	0.030	0.030
BB20030	200 -0.03	280 -0.03	30 -0.12	0.06-0.09	0.030	0.030
BB20035	200 -0.03	295 -0.03	35 -0.12	0.06-0.09	0.030	0.030
BB25025	250 -0.03	310 -0.035	25 -0.12	0.07-0.1	0.035	0.035
BB25030	250 -0.03	330 -0.035	30 -0.12	0.07-0.1	0.035	0.035
BB25040	250 -0.03	355 -0.035	40 0.12	0.07-0.1	0.035	0.035
BB30025	300 -0.035	360 -0.035	25 -0.12	0.07-0.1	0.035	0.035
BB30035	300 -0.035	395 -0.035	35 -0.12	0.07-0.1	0.035	0.035
BB30040	300 -0.035	405 -0.035	40 -0.12	0.07-0.1	0.035	0.035
BB40035	400 -0.04	480 -0.04	35 -0.25	0.08-0.11	0.040	0.040
BB40040	400 -0.04	510 -0.04	40 -0.2	0.08-0.11	0.040	0.040
BB50040	500 -0.045	600 -0.045	40 -0.25	0.09-0.12	0.045	0.045
BB50050	500 -0.045	625 -0.045	50 -0.25	0.09-0.12	0.045	0.045
BB60040	600 -0.045	700 -0.045	40 -0.25	0.09-0.12	0.045	0.045
BB70045	700 -0.045	815 -0.045	45 -0.25	0.09-0.12	0.045	0.045
BB80070	800 -0.05	950 -0.05	70 -0.25	0.09-0.12	0.050	0.050
BB90070	900 -0.05	1050 -0.05	70 -0.25	0.1-0.13	0.050	0.050

CONTACT Kaydon at —
Kaydon Bearings • Muskegon, Michigan 49443
Telephone: 231-755-3741 • Fax: 231-759-4102

Need Service Fast?
1-800-514-3066
www.kaydonbearings.com



Ultra-Slim Thin Section Bearings

Ideal for applications in robotics, inspection equipment, satellites, cameras... anywhere precise positioning and lightweight designs are critical.

At just 2.5 mm wide, Ultra-Slim bearings are available in bore sizes ranging from 35 mm to 170 mm for an array of applications. Their compact profile allows you to use Ultra-Slim bearings in many highly confined spaces.

Precision-engineered Ultra-Slim bearings are made of stainless steel for corrosion resistance. They are available in angular contact (Type A), radial contact (Type C), and four-point contact

(Type X) styles. Torque figures shown are for single bearings with standard internal fit-up, standard lubricant at room temperature, and under 5 pounds thrust load. (See selection charts on the next page.)

Note that Ultra-Slim bearings are not designed to be preloaded and are not recommended for continuous rotation applications, as the cross-section cannot accommodate a separator.

Hybrid bearings with ceramic balls are available upon request. These are used often when lubrication is marginal or when lower wear generation and/or lower torque levels are required.

Figure 2-9

How to identify Ultra-Slim Bearings using our part number code

Position	1	2	3	4	5	6	7	8	9	10
Nomenclature	Material	Bore (mm)		Width(mm)		Type	Separator	Precision	Internal Fit	
Example	S	1	1	0	0	3	C	S	0	K

Explanation of position numbers:

Position 1 – Material

S = AISI 440C races and balls
(Standard for Series)

Positions 2, 3 and 4 – Bore

Nominal bearing bore in mm.

Positions 5 and 6 – Width

Nominal radial race width in mm.

Position 7 – Bearing Type

A = Angular Contact
C = Radial Contact
X = Four-Point Contact

Position 8 – Separator

S = Spacer balls
F = Full complement of load balls

Position 9 – Precision

0 = Kaydon standard Precision Class 1 (higher precision not available in this series)

Position 10 – Internal Fit

A = 0.000 - 0.013 mm clearance
C = 0.013 - 0.025 mm clearance
E = 0.025 - 0.051 mm clearance
K = 0.000 - 0.013 mm preload
M = 0.013 - 0.025 mm preload
empty = standard internal fitup if not specified

Performance and Application Considerations

Ultra-Slim bearings are unique in that their extremely thin cross section enables them to provide great size and weight reductions for light to medium duty applications with slow or intermittent rotation.

Given the fact that these bearings will most likely be used in lightly loaded applications where saving weight and space are the main objective, the loading values shown assume that the shaft and housing will also be of light construction. This will allow for greater bearing ring movement under load than traditional heavy section bearings. Thus the loading limits for capacity are not based on ABMA standards.

Depending on the support provided by the shaft and housing, this movement can create increased stress levels within the bearing. Distortion of the shaft and housing under load will transfer to the bearing, causing increased stress levels which could lead to premature failure and/or erratic torque conditions.

The impact of non-uniform shaft and housing distortions is best found by testing. If problems are experienced, increased rigidity of the shaft and housing may be necessary. If the shaft and housing are of sufficient rigidity, it may be possible for the bearings to support greater loads than the loading limits provided.

Ultra-Slim Bearing Selection Data

Selection Tables

Section 2

Angular Contact Type A

KAYDON Bearing Number	Dimensions in Millimeters				Capacities in Newtons		Loading Limit (N)	Mass in Grams
	Size		Land Diameters		Dynamic ^①	Static ^②		
	Bore	Outside Dia.	L ₁	L ₂	Radial	Radial	Thrust ^③	
S03503ASO	35	41	37.2	38.8	383	382	1334	5
S06003ASO	60	66	62.2	63.8	552	649	1112	9
S07003ASO	70	76	72.2	73.8	609	756	1068	11
S07403ASO	74	80	76.2	77.8	632	799	1045	11
S08003ASO	80	86	82.2	83.8	663	863	1001	12
S09003ASO	90	96	92.2	93.8	716	970	956	13
S10003ASO	100	106	102.2	103.8	765	1077	890	15
S11003ASO	110	116	112.2	113.8	814	1183	867	16
S12003ASO	120	126	122.2	123.8	863	1290	823	18
S13003ASO	130	136	132.2	133.8	912	1407	778	19
S14003ASO	140	146	142.2	143.8	956	1514	734	21
S15003ASO	150	156	152.2	153.8	1001	1621	712	22
S16003ASO	160	166	162.2	163.8	1045	1727	689	24
S17003ASO	170	176	172.2	173.8	1085	1834	667	25

Full complement or spacer ball 1/16" (inch)

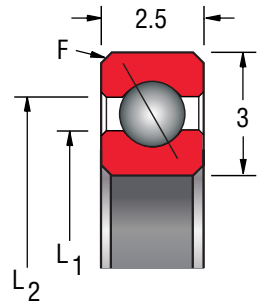

④ F = 0.25
Bearing corners are normally chamfered

Radial Contact Type C

KAYDON Bearing Number	Dimensions in Millimeters				Capacities in Newtons		Mass in Grams
	Size		Land Diameters		Dynamic ^①	Static ^②	
	Bore	Outside Dia.	L ₁	L ₂	Radial	Radial	
S03503CSO	35	41	37.2	38.8	418	418	5
S06003CSO	60	66	62.2	63.8	605	711	9
S07003CSO	70	76	72.2	73.8	667	827	11
S07403CSO	74	80	76.2	77.8	689	875	11
S08003CSO	80	86	82.2	83.8	725	944	12
S09003CSO	90	96	92.2	93.8	783	1062	13
S10003CSO	100	106	102.2	103.8	841	1178	15
S11003CSO	110	116	112.2	113.8	894	1295	16
S12003CSO	120	126	122.2	123.8	943	1412	18
S13003CSO	130	136	132.2	133.8	1001	1540	19
S14003CSO	140	146	142.2	143.8	1050	1658	21
S15003CSO	150	156	152.2	153.8	1099	1774	22
S16003CSO	160	166	162.2	163.8	1143	1891	24
S17003CSO	170	176	172.2	173.8	1192	2006	25

Full complement or spacer ball 1/16" (inch)

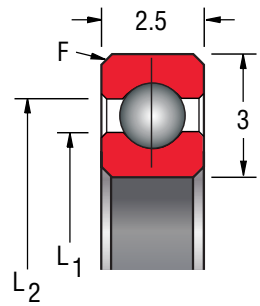

④ F = 0.25
Bearing corners are normally chamfered

4-Point Contact Type X

KAYDON Bearing Number	Dimensions in Millimeters				Capacities in Newtons		Loading Limit		Mass in Grams
	Size		Land Diameters		Dynamic ^①	Static ^②	Thrust ^③ (N)	Moment ^③ (N-m)	
	Bore	Outside Dia.	L ₁	L ₂	Radial	Radial			
S03503XS0	35	41	37.2	38.8	585	711	1045	7.9	5
S06003XS0	60	66	62.2	63.8	847	1208	934	11.8	9
S07003XS0	70	76	72.2	73.8	934	1407	890	13.0	11
S07403XS0	74	80	76.2	77.8	965	1487	867	13.4	11
S08003XS0	80	86	82.2	83.8	1015	1606	845	14.0	12
S09003XS0	90	96	92.2	93.8	1096	1805	801	14.9	13
S10003XS0	100	106	102.2	103.8	1177	2003	756	15.6	15
S11003XS0	110	116	112.2	113.8	1252	2201	734	16.6	16
S12003XS0	120	126	122.2	123.8	1320	2400	689	17.0	18
S13003XS0	130	136	132.2	133.8	1401	2618	645	17.2	19
S14003XS0	140	146	142.2	143.8	1470	2818	623	17.8	21
S15003XS0	150	156	152.2	153.8	1538	3016	601	18.4	22
S16003XS0	160	166	162.2	163.8	1600	3215	578	18.9	24
S17003XS0	170	176	172.2	173.8	1669	3413	556	19.2	25

Full complement or spacer ball 1/16" (inch)

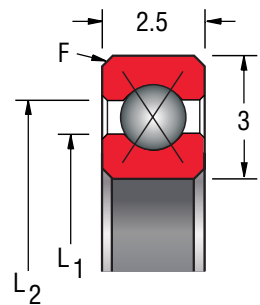

④ F = 0.25
Bearing corners are normally chamfered

① Dynamic radial capacities are included for life calculation purposes. These are based on the assumption that the shaft and housing have adequate strength to support the loads without causing excessive distortion of the bearing rings.

② Static radial capacities are based on maximum allowable contact stresses. Adequate support of the races is assumed to help assure uniform ball support.

③ Higher loading limits may be achieved with sufficiently rigid supports that will better restrict the movement of the bearing races under load.

④ Corner size is the maximum shaft or housing fillet radius that the bearing corners will clear.

Precision Tolerances & Recommended Fits for Ultra-Slim Bearings

All dimensions in millimeters

Kaydon class 1 for A, C, X type bearings

Bearing Size (mm Series)	① Bore and O.D. Tolerances Nominal +0.000	② Radial and Axial Race Runouts		Rotating Shaft or Duplex DF Mounting		Stationary Shaft or Duplex DB Mounting		Bearing Diametral Clearance*, Type X & C Before Installation	
		Inner Race	Outer Race	Shaft Diameter Nominal	Housing Bore Nominal	Shaft Diameter Nominal	Housing Bore Nominal		
035	-0.013	0.010	0.010	35 +0.013/-0.000	41 +0.013/-0.000	34.987 +0.000/-0.013	40.987 +0.000/-0.013	0.030	0.046
060	-0.013	0.013	0.013	60 +0.013/-0.000	66 +0.013/-0.000	59.987 +0.000/-0.013	65.987 +0.000/-0.013	0.030	0.046
070	-0.013	0.015	0.015	70 +0.013/-0.000	76 +0.013/-0.000	69.987 +0.000/-0.013	75.987 +0.000/-0.013	0.030	0.046
074	-0.013	0.015	0.015	74 +0.013/-0.000	80 +0.013/-0.000	73.987 +0.000/-0.013	79.987 +0.000/-0.013	0.030	0.046
080	-0.013	0.015	0.015	80 +0.013/-0.000	86 +0.013/-0.000	79.987 +0.000/-0.013	85.987 +0.000/-0.013	0.030	0.046
090	-0.013	0.015	0.015	90 +0.013/-0.000	96 +0.013/-0.000	89.987 +0.000/-0.013	95.987 +0.000/-0.013	0.030	0.046
100	-0.013	0.015	0.015	100 +0.013/-0.000	106 +0.013/-0.000	99.987 +0.000/-0.013	105.987 +0.000/-0.013	0.030	0.046
110	-0.013	0.020	0.020	110 +0.013/-0.000	116 +0.013/-0.000	109.987 +0.000/-0.013	115.987 +0.000/-0.013	0.030	0.046
120	-0.013	0.020	0.020	120 +0.013/-0.000	126 +0.013/-0.000	119.987 +0.000/-0.013	125.987 +0.000/-0.013	0.030	0.046
130	-0.013	0.020	0.020	130 +0.013/-0.000	136 +0.013/-0.000	129.987 +0.000/-0.013	135.987 +0.000/-0.013	0.030	0.046
140	-0.013	0.025	0.025	140 +0.013/-0.000	146 +0.013/-0.000	139.987 +0.000/-0.013	145.987 +0.000/-0.013	0.030	0.046
150	-0.013	0.025	0.025	150 +0.013/-0.000	156 +0.013/-0.000	149.987 +0.000/-0.013	155.987 +0.000/-0.013	0.030	0.046
160	-0.013	0.025	0.025	160 +0.013/-0.000	166 +0.013/-0.000	159.987 +0.000/-0.013	165.987 +0.000/-0.013	0.030	0.046
170	-0.013	0.025	0.025	170 +0.013/-0.000	176 +0.013/-0.000	169.987 +0.000/-0.013	175.987 +0.000/-0.013	0.030	0.046

① Diameter tolerances apply to average dimensions. Due to the thin nature of these bearings, they cannot be measured with 2 point gauges.

② The runout values apply to individual bearing races.

* Diametral clearance after installation theoretically can range rather widely if all contributing bearing, housing, and shaft tolerances are at either of their extremes. Diametral clearances shown do not apply to Type A (angular contact) bearings.

Race Width Tolerance-Single Type C, X, A Bearings: All sizes +.000 -.127

Listed shaft and housing diameters are for steel supports with standard bearing diametral clearance. Recommended shaft and housing diameters can change greatly based on orientation, temperature, speed, non-standard diametral clearances, and desired performance characteristics. Contact Kaydon for design assistance when required.

CONTACT Kaydon at —
Kaydon Bearings • Muskegon, Michigan 49443
Telephone: 231-755-3741 • Fax: 231-759-4102



Need Service Fast?
1-800-514-3066
www.kaydonbearings.com



Only from Kaydon: Reali-Slim TT Series

Small-scale, Thin Section Turntable Bearings

To save weight, reduce product envelope sizes and increase design flexibility — without compromising bearing performance and life — customers told us they'd welcome a more compact turntable bearing design.

We responded by designing the first small-scale, thin section turntable bearings, for such demanding applications as robotics, radar antennae, and factory positioning and inspection tables... the Reali-Slim TT Series. The advantages of this series vs. conventional turntable bearings include:

Significantly smaller size for greater design versatility and reduced weight;

Greater accuracy — extended radial bearing section increases rigidity, with optional preload or clearances to meet application torque or deflection requirements;

Easier to use — fast installation and changeout;

Custom configurations to meet your application's specific

needs — many drive options, gearing/timing belt, mounting hole types; and

Designed to **withstand harsh operating environments** — AISI-440C steel races, steel reinforced seals.

Figure 2-10

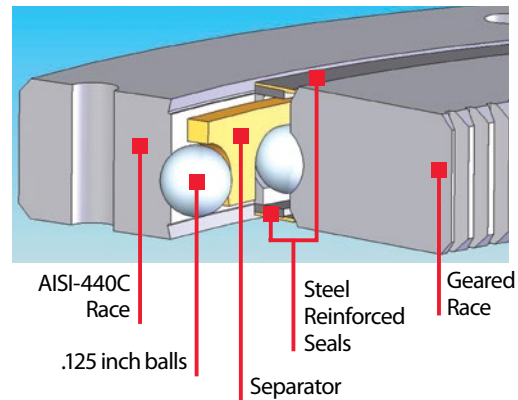

The configurations and specifications you need for more compact, more precise turntable designs

Example of part number breakdown

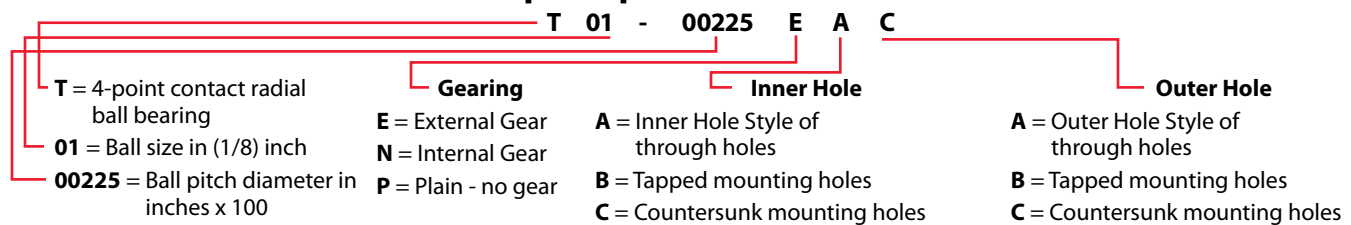

Holes sized for #4-40 screws, tapped, countersunk, or through gears set at full depth involute, 64 DP, 20° pressure angle

Four-Point Contact Bearing (Reali-Slim TT Series)

Bearings are most often designed to handle either radial or axial load conditions. But the Reali-Slim TT Series four-point contact bearings have a unique inner and outer race geometry that enables a single bearing to carry three types of loading (radial, axial and moment) simultaneously. This makes it the bearing of choice for many applications since a single four-point contact bearing can often replace two bearings, providing a simplified design.

Reali-Slim TT Series bearings may also be furnished with an internal diametral preload for those applications requiring greater stiffness or zero free play. This is accomplished by using balls that are larger than the space provided in the raceways. The

balls and raceways, therefore, have some elastic deformation in the absence of an external load.

Figure 2-11

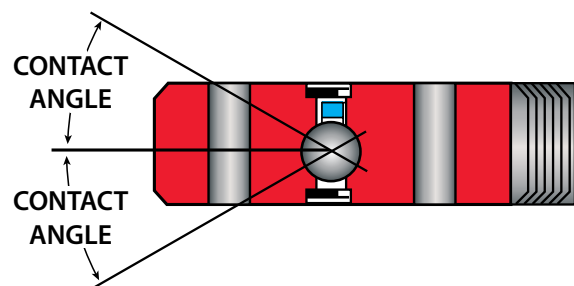

Reali-Slim TT Series Turntable Bearings (continued)**Four-Point Contact Bearing (Reali-Slim TT Series)**

Basic Part Number	Dynamic			Static			Static Torque (in. - lbs.)	Approx. Weight (lbs.)
	Radial (lbs.)	Thrust (lbs.)	Moment (in. - lbs.)	Radial (lbs.)	Thrust (lbs.)	Moment (in. - lbs.)		
T01-00225	520	790	440	680	1,710	770	3.4	0.35
T01-00275	580	910	600	830	2,090	1,150	4.4	0.43
T01-00325	640	1,010	780	990	2,470	1,600	5.5	0.50
T01-00375	700	1,110	980	1,140	2,850	2,130	6.5	0.59
T01-00425	750	1,210	1,200	1,290	3,220	2,740	7.4	0.67
T01-00450	780	1,260	1,320	1,370	3,410	3,070	7.9	0.70
T01-00475	810	1,310	1,440	1,440	3,600	3,420	8.5	0.74
T01-00500	830	1,350	1,560	1,520	3,790	3,790	9.0	0.78
T01-00525	860	1,400	1,690	1,590	3,980	4,180	9.5	0.82
T01-00575	910	1,480	1,950	1,750	4,360	5,020	10.4	0.89
T01-00625	950	1,570	2,230	1,900	4,740	5,930	11.3	0.98
T01-00675	1,000	1,650	2,530	2,050	5,120	6,910	12.2	1.05

Torque based on seal drag in addition to a light preload

Note: Reali-Slim TT Series turntable bearings are custom designed to meet your application's needs.
Contact Kaydon for lead time.

Non-geared Bearings – All dimensions in inches

Part Number with Through Holes	Bore	O.D.	Inner Land	Outer Land	Inner Bolt Circle	Number of holes	Outer Bolt Circle	Number of holes
T01-00225PAA	1.500	3.000	2.148	2.356	1.813	6	2.688	8
T01-00275PAA	2.000	3.500	2.648	2.856	2.313	8	3.188	10
T01-00325PAA	2.500	4.000	3.148	3.356	2.813	9	3.688	12
T01-00375PAA	3.000	4.500	3.648	3.856	3.313	10	4.188	14
T01-00425PAA	3.500	5.000	4.148	4.356	3.813	12	4.688	15
T01-00450PAA	3.750	5.250	4.398	4.606	4.063	12	4.938	16
T01-00475PAA	4.000	5.500	4.648	4.856	4.313	14	5.188	16
T01-00500PAA	4.250	5.750	4.898	5.106	4.563	14	5.438	18
T01-00525PAA	4.500	6.000	5.148	5.356	4.813	15	5.688	18
T01-00575PAA	5.000	6.500	5.648	5.856	5.313	16	6.188	20
T01-00625PAA	5.500	7.000	6.148	6.356	5.813	18	6.688	22
T01-00675PAA	6.000	7.500	6.648	6.856	6.313	20	7.188	22

Externally Geared Bearings – All dimensions in inches

Part Number with Through Holes	Bore	Gear O.D.	Inner Land	Outer Land	Inner Bolt Circle	Number of holes	Outer Bolt Circle	Number of holes	Gear Pitch Dia.	Number of teeth
T01-00225EAA	1.500	3.078	2.148	2.356	1.813	6	2.688	8	3.047	195
T01-00275EAA	2.000	3.578	2.648	2.856	2.313	8	3.188	10	3.547	227
T01-00325EAA	2.500	4.078	3.148	3.356	2.813	9	3.688	12	4.047	259
T01-00375EAA	3.000	4.578	3.648	3.856	3.313	10	4.188	14	4.547	291
T01-00425EAA	3.500	5.078	4.148	4.356	3.813	12	4.688	15	5.047	323
T01-00450EAA	3.750	5.328	4.398	4.606	4.063	12	4.938	16	5.297	339
T01-00475EAA	4.000	5.578	4.648	4.856	4.313	14	5.188	16	5.547	355
T01-00500EAA	4.250	5.828	4.898	5.106	4.563	14	5.438	18	5.797	371
T01-00525EAA	4.500	6.078	5.148	5.356	4.813	15	5.688	18	6.047	387
T01-00575EAA	5.000	6.578	5.648	5.856	5.313	16	6.188	20	6.547	419
T01-00625EAA	5.500	7.078	6.148	6.356	5.813	18	6.688	22	7.047	451
T01-00675EAA	6.000	7.578	6.648	6.856	6.313	20	7.188	22	7.547	483

Real-Slim TT Series Turntable Bearings (continued)

Internally Geared Bearings – All dimensions in inches

Part Number with Through Holes	Gear I.D.	O.D.	Inner Land	Outer Land	Inner Bolt Circle	Number of holes	Outer Bolt Circle	Number of holes	Gear Pitch Dia.	Number of teeth
T01-00225NAA	1.422	3.000	2.148	2.356	1.813	6	2.688	8	1.453	93
T01-00275NAA	1.922	3.500	2.648	2.856	2.313	8	3.188	10	1.953	125
T01-00325NAA	2.422	4.000	3.148	3.356	2.813	9	3.688	12	2.453	157
T01-00375NAA	2.922	4.500	3.648	3.856	3.313	10	4.188	14	2.953	189
T01-00425NAA	3.422	5.000	4.148	4.356	3.813	12	4.688	15	3.453	221
T01-00450NAA	3.672	5.250	4.398	4.606	4.063	12	4.938	16	3.703	237
T01-00475NAA	3.922	5.500	4.648	4.856	4.313	14	5.188	16	3.953	253
T01-00500NAA	4.172	5.750	4.898	5.106	4.563	14	5.438	18	4.203	269
T01-00525NAA	4.422	6.000	5.148	5.356	4.813	15	5.688	18	4.453	285
T01-00575NAA	4.922	6.500	5.648	5.856	5.313	16	6.188	20	4.953	317
T01-00625NAA	5.422	7.000	6.148	6.356	5.813	18	6.688	22	5.453	349
T01-00675NAA	5.922	7.500	6.648	6.856	6.313	20	7.188	22	5.953	381

The design features and options you asked for

Custom Real-Slim TT Series thin section bearings have a proven, four-point contact ball radial design, featuring a single row of balls with a unique gothic arch raceway and brass separators for low frictional torque. Radial, axial and moment load-capable, the bearings are prelubricated and ready for use; simply position the bearings on the mounting face and tighten the mounting screws! They are available with optional internal or external spur gear for ease of drive setup, or with non-geared designs.

Geared options are 64 diametral pitch with 20° pressure angle and provide low-backlash service. Built-in seals are a low-torque design, and made of rugged, reliable, steel-reinforced nitrile rubber.

Mounting holes are sized for #4-40 UNC fasteners with optional styles — .136 through holes and countersunk holes, and tapped through. Non-geared races have mounting piloting diameters controlled to .0008 inches.

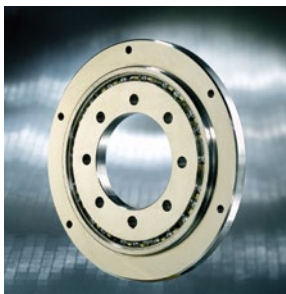

No gear with through holes



External gear with tapped holes

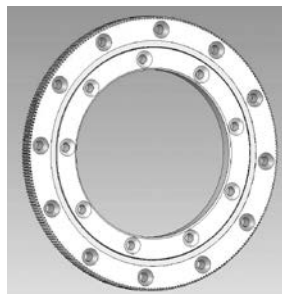

Externally geared bearing with countersunk holes

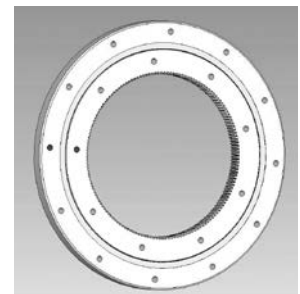

Internal gear with tapped holes

Section 3 — Applications Engineering

**Page
Number**

■ Bearing Selection	90
■ Capacity, Life, and Load Analysis	95

Bearing Selection

Type C—Radial Contact

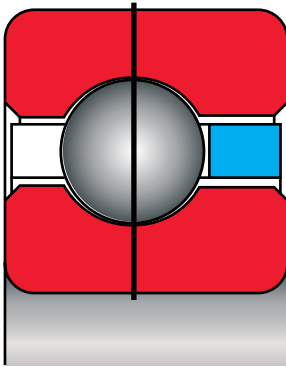

The Type C Radial Contact ball bearing is a single-row radial ball bearing with extra deep ball grooves in both rings (groove depth = 25% of ball diameter). Normally this bearing is assembled by eccentric displacement of the inner race within the outer race which permits insertion of about half of a full complement of balls. After insertion of the balls, the races are positioned concentrically and the balls are spaced about the entire circumference for assembly of the separator. This method of assembly is commonly termed “Conrad Assembly.”

An alternate method of assembly is to insert balls through a “filling slot” made by notching the raceway shoulder of one or both races. This method permits assembly with up to a full complement of balls for additional load capacity, however, there are limitations on the operating conditions and these are discussed under Separator Types.

Type C bearings perform best with a small amount of clearance between the balls and races (diametral clearance). Standard bearings are supplied with clearances for:

- Interference fitting between bearing races and mounting members;
- Differential thermal expansion or contraction of steel races;
- Misalignment between shaft and housing and other factors may require the clearance to be adjusted accordingly.

The Type C radial contact bearing is designed to have ball to race contact in the plane of the ball centers when pure radial load is

applied and thrust forces are absent. Necessary diametral clearance may be increased or decreased to meet operating conditions.

While designed primarily for radial load application, the Type C bearing, without a filling slot, will accept some axial (thrust) load in either direction. Its ability to resist axial load, however, is dependent upon the amount of clearance in the bearing after installation. It is this clearance which allows the balls, under axial load, to contact the races at an angle, thereby offering resistance to such load. In the case of the bearing with a filling slot, the notches interrupt the ball contact paths under axial load, minimizing the dynamic thrust capability. Where axial load is present, therefore, rotation of the filling slot bearing must be restricted.

By increasing the diametral clearance beyond the standard amount, the Type C bearing can have a greater angle of contact under axial load, and thus greater thrust capacity. In this case, it is proper to adjust the bearing against another bearing of similar construction to reduce axial movement under reversing thrust forces. Used in this manner, the bearing is essentially an angular contact rather than a radial contact bearing.

Type A—Angular Contact

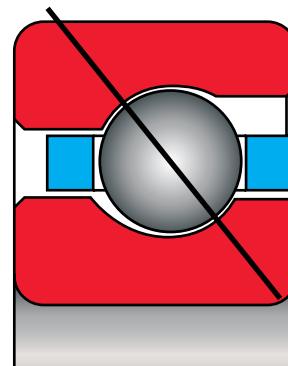

Type A Angular Contact ball bearings differ from Type C bearings in that Type A bearings have sufficient diametral clearance to produce a substantial angle of contact for resistance to axial load. This contact angle is 30° in the standard bearing. As in the Type C bearing, extra deep ball grooves are used (25% of ball diameter).

The distinguishing feature of the Type A bearing lies in the method of assembly. One ring, usually the outer, is counter-

Bearing Selection (continued)

bored to reduce one shoulder of the raceway to the extent that with the assistance of a temperature differential between the two rings, the outer ring can be installed over the inner race, ball, and separator assembly. This provides a non-separable bearing capable of carrying greater radial loads while resisting a substantial axial force in one direction. With an axial force applied, the faces of the inner and outer rings are approximately flush to minimize preload adjustments.

This assembly method permits the use of a greater complement of balls than is possible in the Type C bearing without filling slots, and together with the sizable contact angle, gives the Type A bearing its greater thrust capacity.

Because of its unidirectional thrust capability, this bearing should be mounted opposed to another bearing such that an axial force is present to establish and maintain the contact angle and to minimize axial movement under reversing thrust loads.

Back-to-back Mounting

Figure 3-1

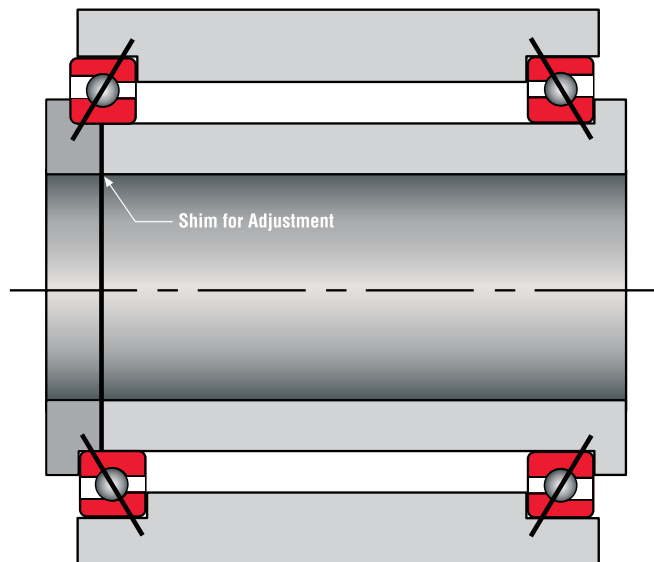

Typical mountings of Type A bearings are shown in Figures 3-1 and 3-2. In Figure 3-1, the bearings are mounted with the lines of

contact converging outside of the bearings. This is commonly called a “back-to-back” mounting. In this figure, the bearings are adjustable through the inner races by use of shims under the inner race clamping ring. Sufficient shim thickness is provided initially to allow axial movement of the shaft relative to the housing. The total axial movement can then be measured and the shim thickness reduced by the amount of movement plus any additional amount desired for preload. When two bearings are opposed to each other to the extent that all internal clearance is removed and elastic deformation occurs between the balls and raceways, the bearings are said to be “preloaded.”

Face-to-face Mounting

Figure 3-2

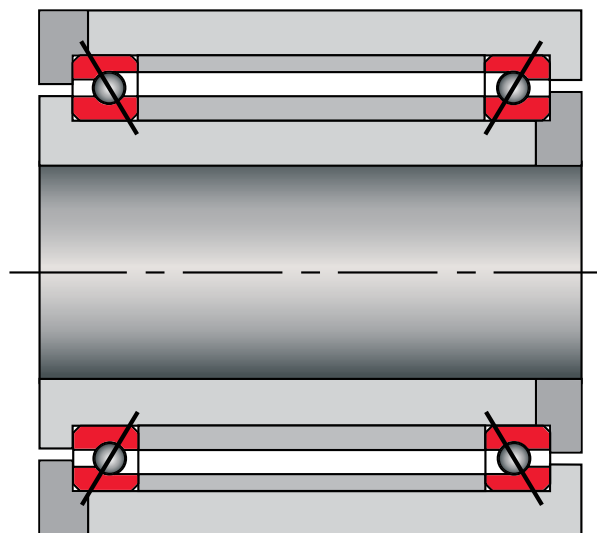

In Figure 3-2, the bearings are mounted “face-to-face” with the contact lines converging inward. Spacers are used between both the inner and outer races and adjustment is possible by varying the length of one spacer relative to the other. Normally, however, the spacers are equal in length and the bearings are furnished as a matched pair with a predetermined internal fit. If the outer race spacer were removed from this assembly, the bearings could be adjusted by use of shims under the outer race clamping ring.

Bearing Selection (continued)

Duplexed Bearings

Type A bearings are furnished as matched sets — available direct from the factory — when they are to be mounted adjacent or with equal length inner and outer race spacers. When required, Kaydon can supply assemblies with matched ground spacers. The arrangements shown in Figures 3-3, 3-4, and 3-5 are known as duplexed bearings — back-to-back, face-to-face, and tandem, respectively. Sets of three, four or more bearings can also be matched where conditions require additional capacity and there is insufficient space radially for larger bearings.

The bearings in these sets are matched within close limits for size of bore and outside diameter. Each set is marked with a “V” across the bores and outside diameters at the high point of radial runout and indicate the proper orientation of the races at installation (Figure 3-5).

The pairs shown in Figures 3-3 and 3-4 are normally furnished with the race faces ground to provide preload when installed. To

accomplish this, a gap is provided between the inner races of the pair in Figure 3-3 and between the outer races of the pair in Figure 3-4. When the bearings are installed and clamped axially, the gap is closed, producing a preload on the bearings.

Back-to-back arrangement of Figures 3-1 and 3-3 offers greater rigidity under moment loading and should be used when the space between single bearings is small or when a single pair of adjacent bearings is employed.

Face-to-face arrangement is more tolerant of misalignment between the shaft and housing and should be considered when there are multiple pairs of bearings along an axis. When single bearings are mounted face-to-face, they must be spaced sufficiently to provide resistance to moment load. If required, a face-to-face pair can be mounted in conjunction with another bearing in a “fixed-float” arrangement with the pair in the fixed position. (Also see Section 5, Mounting.)

Tandem bearing sets have single direction thrust capacity and must be mounted opposed to another bearing or set.

Figure 3-3
Back-to-back (Type DB)

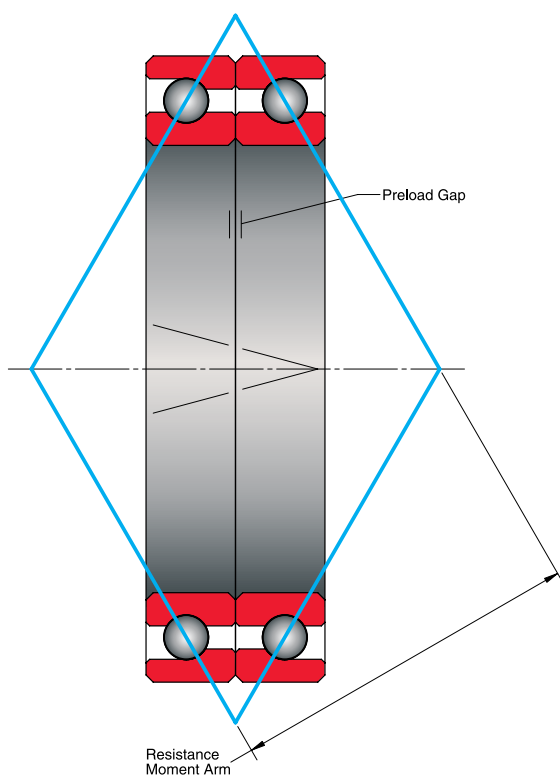

Figure 3-4
Face-to-face (Type DF)

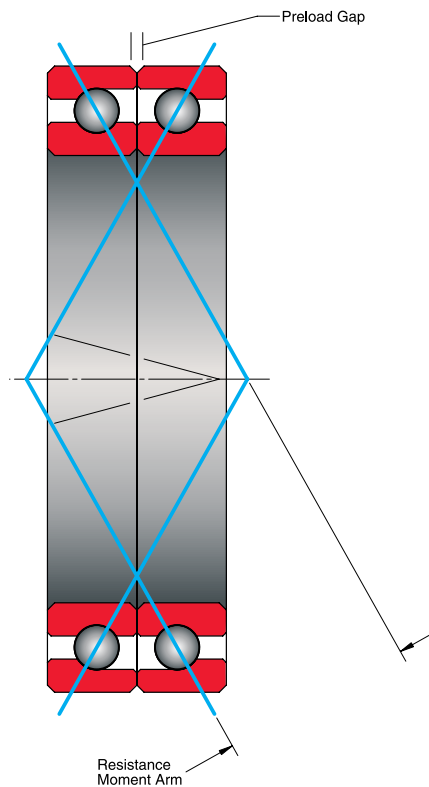
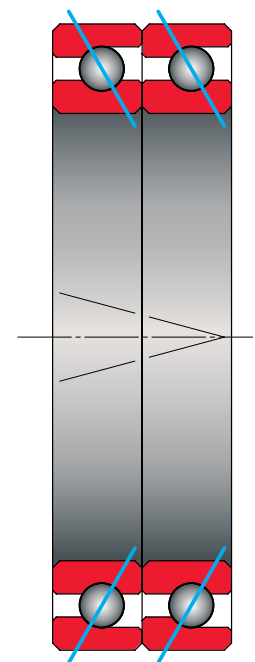

Figure 3-5
Tandem (Type DT)



Bearing Selection (continued)

When applying catalog load ratings to matched sets, the total radial capacity is considered equal to the single bearing radial rating multiplied by $N^{0.7}$, where N is the number of bearings in the set. The thrust capacity in each direction is considered equal to the single bearing thrust rating multiplied by $N^{0.7}$, where N is the number of bearings resisting thrust in that direction.

Unless specifically requested, the outboard faces of bearing sets are not controlled. If outboard face flushness is required for preload purposes, universally ground bearings should be considered. On universally ground bearings, both inboard and outboard faces are matched under a specified gage load to control preload and allow for mounting orientation flexibility.

Type X—Four Point Contact

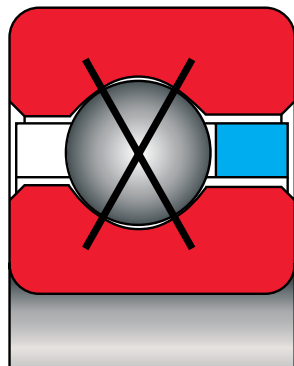

The Type X Four-Point Contact ball bearing is distinguished from Types A and C by the geometry of its ball grooves. In Type C, the centers of the radii both lie in the plane of the ball centers (Figure 3-6). In Type A with the races and balls in angular contact, the centers of the groove radii are offset equal amounts on either side of the plane of the ball centers (Figure 3-7). In the Type X bearing the groove in each race has two radii whose centers are offset from the plane of the ball centers (Figure 3-8). The latter construction gives the Type X bearing its unique “Gothic Arch” configuration, making possible four contact points between a ball and the raceways.

Type X bearings are assembled by the methods described in Type C bearings, either Conrad or filling slot. With a filling slot, both the dynamic radial and thrust capabilities are impaired by the interruption of the ball contact path, and speed of rotation must be limited.

The depth of groove in the Type X bearing is the same as in Types A and C (25% of ball diameter). The deep groove combined with the four-point contact geometry enables this bearing to resist a combination of radial, thrust, and moment loading. The manner in which the bearing accomplishes this is similar to that of a pair of Type A bearings duplexed back-to-back.

Figure 3-6
Type C

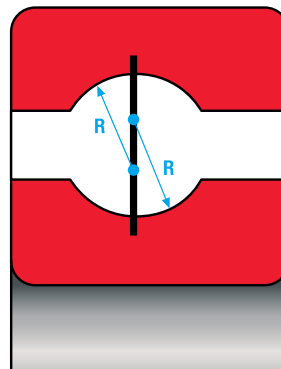

Figure 3-7
Type A

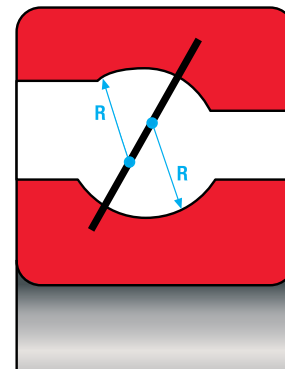
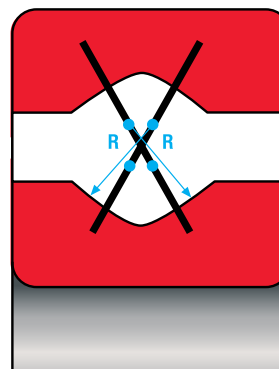

Figure 3-8
Type X



Bearing Selection (continued)

Referring to Figure 3-9, an axial force applied to the inner race from right to left is passed from the race to the ball at point B. It is then transmitted through the ball to point D where it passes into the outer race and support structure. The line of action BD forms a nominal 30° angle with the radial centerline of the bearing. Because of the elastic deformation of the ball and the race grooves along the load-transmission line, the ball load is relieved at points A and C, permitting smooth rotation around an axis perpendicular to line BD. With an axial force applied to the inner race from left to right, a similar transmission of load occurs between points C and A.

Figure 3-9

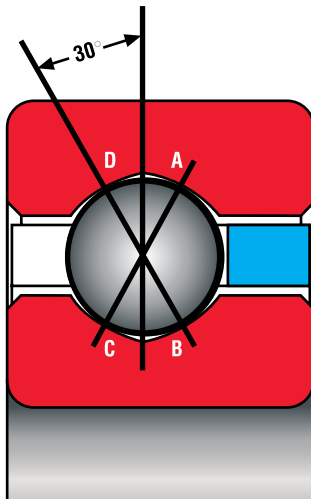

Moment or Overturning Load

A moment or overturning load is similar to two thrust loads acting in opposite directions at diametrically opposite sides of the bearing. With a moment load, the loading on one side of the bearing will pass from point B to D, relieving points A and C. Directly across the bearing, the load passes from point C to point A, relieving points B and D.

A radial load is resisted equally across the lines of contact CA and BD. Under combined loading the resistance is along both lines of contact with the magnitude of each reaction dependent upon the relationship of the individual loads.

By its ability to resist radial, thrust, and moment loads in any combination, the Type X bearing is often able to replace two bearings—a pair of angular contact ball bearings, a pair of

tapered roller bearings, or a combination of thrust and radial bearings, either ball or roller.

As in the case of the Type C bearing, Type X bearings are normally supplied with diametral clearance. The latter bearing, however, is not dependent upon this clearance for its nominal contact angle and thrust capacity. On the contrary, where thrust or moment loading is considerable, the clearance should be minimized to prevent the angle of contact from becoming excessive. For many applications requiring greater stiffness, Type X bearings are furnished with an internal preload. This is accomplished by using balls larger in diameter than the space provided between the raceways. The balls and raceways in this case have some elastic deformation without the presence of external load.

NOTE: Type X Bearings are designed to be used singularly. Use of two Type X bearings on a common shaft could result in objectionable friction torque.

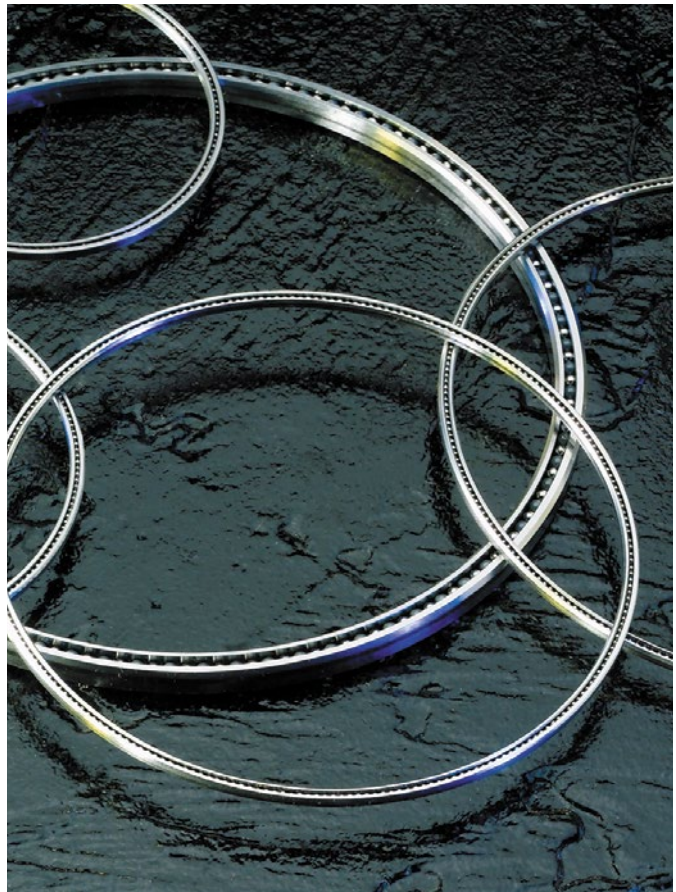

Capacity, Life, and Load Analysis of Reali-Slim Ball Bearings

ABMA 9:1990/ISO 281:1990

Many bearing manufacturers calculate dynamic radial capacity in accordance with the formulas in ABMA Standard 9 and ISO 281-1990. However, in Kaydon's judgment these equations are overly optimistic because they assume certain design details that are not valid for thin section bearings.

The capacities of Kaydon bearings as calculated using these equations are included for comparison purposes only. Alongside these ABMA 9:1990/ISO 281:1990 capacities, readers will find Kaydon Radial Capacities, which are calculated using more realistic assumptions based on actual design details and validated by decades of fatigue life testing. Please see the Kaydon white paper "Not All Thin Section Bearings Are Created Equal," available at our website: http://www.kaydonbearings.com/white_papers_1B.htm.

Increased Capacity

The values in Kaydon radial capacities are consistent with both ABMA Std. 9 and ISO 281 calculations, when the proper assumptions are considered. The increased capacities apply to bearings with standard internal clearance. The new values assume that a certain amount of clearance is left in the bearing after installation.

The biggest increase is in the radial capacity of four-point contact (Type X) bearings. Under the old rating system, four-point contact bearings were given the same capacity as radial (Type C) bearings. However, in this type of bearing the ball loads are distributed over two lines of contact on each race. This gives lower contact stress and longer life, as demonstrated by Kaydon testing.

Life

The dynamic capacity values shown in this catalog are based on actual data from fatigue life testing. The capacities are based on 1,000,000 revolutions L_{10} fatigue life. This is the industry standard that was established for ease of calculation. It is not advisable to apply loads equal to the dynamic capacities in an actual application. Continuous rotation under these conditions would not normally yield acceptable life.

L_{10} fatigue life is that life which 90% of a representative group of identical bearings can be expected to achieve or exceed before evidence of subsurface material fatigue appears. The life of the remaining 10% is unpredictable. The life which 50% of the bearings may be expected to achieve or exceed is approximately 5 times the L_{10} life. This is known as the L_{50} or median life.

There is no significant difference between the dynamic capacity for inner race rotation versus outer race rotation. This is due to the relatively small ratio of ball diameter to pitch diameter in Reali-Slim bearings.

Static load capacities are shown in this catalog. However, the actual static load a Reali-Slim bearing can withstand is dependent upon the amount of support provided by the shaft and housing.

The published capacity numbers allow the user to quickly estimate the bearing L_{10} life for a one-dimensional load case. The life can be estimated using one of the following equations:

$$L_{10} = \left(\frac{C}{P}\right)^3 \cdot 1,000,000 \text{ revolutions}$$

Where: L_{10} = life in revolutions
 C = Kaydon dynamic rating
 P = Applied load (effective)

or

For determining the life in hours at a given speed of rotation the above formula can be changed to read:

$$L_h = \left(\frac{C}{P}\right)^3 \cdot \left(\frac{16,667}{S}\right) \text{ hours}$$

Where: L_h = L_{10} life in hours
 S = Speed in RPM

For multiple load cases or non-standard internal fits, the analysis becomes more complicated. Contact Kaydon Engineering for these cases or consult Reali-Design software available on our website: www.kaydonbearings.com.

It should be noted that the capacities published in this catalog are best used for comparison purposes. The actual value of a life calculation is only valid for an individual load case and the internal fitup for which the number was derived. Since it is very rare to have a truly radial or axial or moment load, these are not normally used for a life calculation.

Load Analysis

Previous versions of this catalog have discussed applying the loads from a free body diagram to a bearing system and solving for each of four reactions. As there are generally three equations (one for radial, one for axial, one for moment loads) and four unknowns, one of the reactions has been assumed to be zero. Once the remaining reactions are resolved, the life of the bearing can be determined.

Capacity, Life, and Load Analysis of Reali-Slim Ball Bearings (continued)

This method had several drawbacks, including:

- It suggested very low bearing life for systems with predominantly axial loads.
- Internal bearing fitup could not be included in the life calculation.
- All loading was assumed to be distributed around the bearing as though it were a pure radial load... regardless of its origin.

Modern computers and software allow for a more complicated and accurate method of determining life. Illustrated here are the results of this process. The actual loads are applied to the bearing and the resultant load on each and every ball in that bearing is determined. From this data, the static safety factor and dynamic L_{10} life can be determined.

To better understand this, the following should be considered:

Primary Radial Loading

- Larger clearances will have fewer balls carrying the loads, resulting in lower dynamic lives.
- Larger preloads may overload the bearing before the loads are applied.

Primary Axial and Moment Loading

- Larger clearances will permit a higher contact angle than the ball has with the raceway, and thus better support the applied loading.
 - However, the ball-to-raceway contact area may spill over the edge of the race, causing other problems.
- Larger preloads may again overload the bearing before the loads are applied.

The method for calculating either a static safety factor or dynamic life requires a computer to determine the individual ball loads throughout the bearing. When these have been calculated, the maximum loaded ball is used to determine a maximum stress level and thus a static safety factor. All of the ball loads are used in a weighted analysis to determine the dynamic L_{10} life.

Since these calculations require a computer, the mathematics required are not shown here. To complete such an analysis, utilize the Kaydon supplied software — Reali-Design or Reali-Design MM — available at www.kaydonbearings.com.

To better understand these principles, graphical representations

of ball distribution around each of three common bearing types are shown in Figures 3-10 through 3-12. Here the ball load distribution and magnitude can be visualized. The higher the peak, the higher the loads.

Figure 3-10

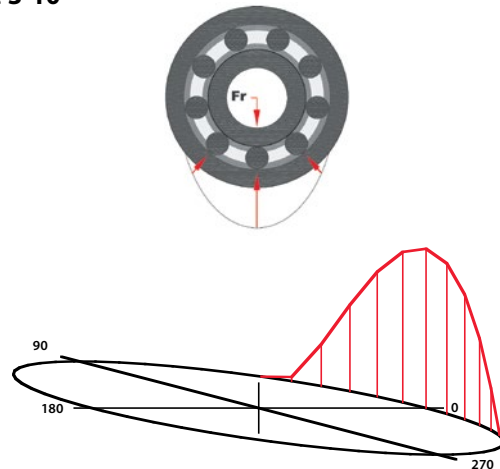

KA040CP0 with 100 lbs. radial load
Clearance in the bearing; few balls carry the load.

This radial bearing contains clearance. There are only three balls supporting this load, with a very high maximum value for the bottom ball.

Figure 3-11

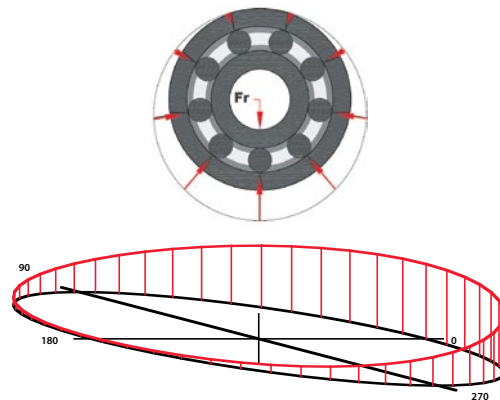

KA040CP0K with 100 lbs. radial load
Light preload in the bearing; all balls carry the load.

This radial bearing contains a light preload. All the balls have some load on them and, as can be seen, the bottom middle ball has far less load than the example above.

Capacity, Life, and Load Analysis of Reali-Slim Ball Bearings (continued)

Figure 3-12

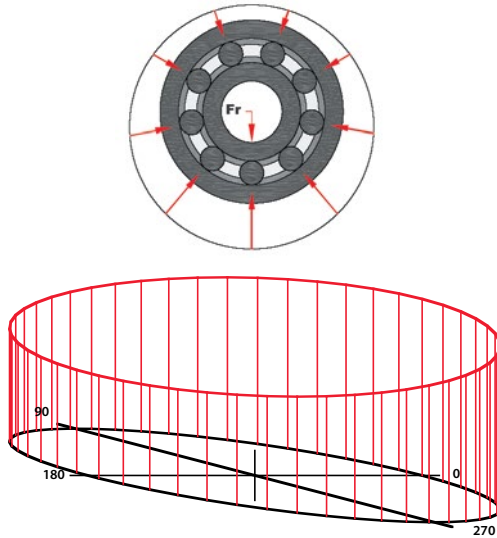

KA040CPOP with 100 lbs. radial load.
Heavy preload.

This radial contact bearing contains a very heavy preload. All the balls have load on them, and the load on the bottom ball is just as high as the bearing with clearance in the first example.

- Increased Capacity
- Increased Life
- Backed by Theory and Testing

Similar diagrams are shown below for other instances.

Figure 3-13

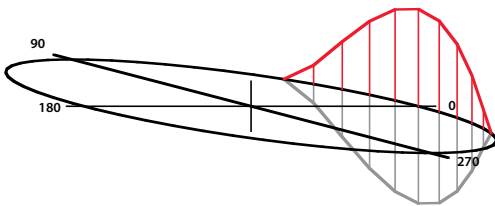

KA040XP0 with 100 lbs. Radial Load
Clearance in bearing; few balls carry the load.

Figure 3-15

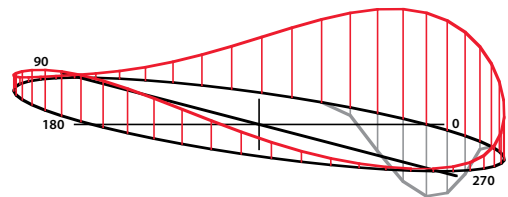

**KA040XP0 with
100 lbs. Radial Load, 100 lbs. Axial Load
30 Inch-lbs. Moment Load**

Figure 3-14

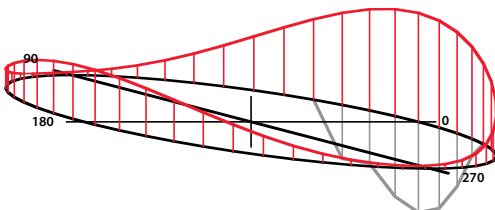

**KA040XP0 with
100 lbs. Radial Load, 100 lbs. Axial Load**
Lower ball contact, mostly unloaded.

Figure 3-16

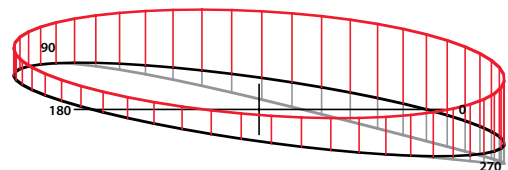

**KA040XP0K with
100 lbs. Radial Load, 100 lbs. Axial Load
30 Inch-lbs. Moment Load**

Capacity, Life, and Load Analysis of Reali-Slim ball bearings (continued)

Figure 3-17 shows a typical mounting of two angular contact bearings subject to external forces F_r and F_t .

Figure 3-17

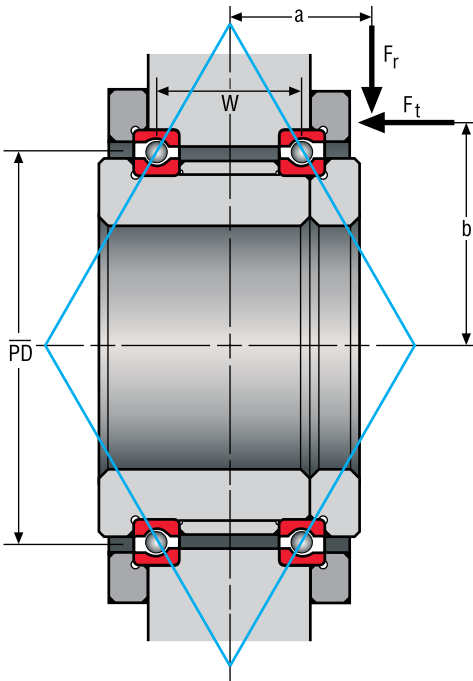

Load Diagram for a Back-to-Back Duplex Pair

- Radial Load = F_r
- Axial Load = F_t
- Moment Load = $F_r a - F_t b$

Consult Kaydon's exclusive Reali-Design software for resultant load calculations.

Variable Load Cases

Often a bearing system must operate in several modes such as "idle" and "working." In this instance, the loads may vary substantially. It is advantageous to calculate the life of the bearing under the total loading spectrum. To do this, the individual life under each load case can be calculated alone, then combined to provide the system life for a particular duty cycle.

To perform this calculation, break the loading up into discrete sections which can have their respective percentage of revolutions represented as part of the total, such as:

Case 1	Case 2	Case 3
Radial ₁	Radial ₂	Radial ₃
Axial ₁	Axial ₂	Axial ₃
Moment ₁	Moment ₂	Moment ₃
% time ₁	% time ₂	% time ₃
L_1	L_2	L_3

Substitute the individual " L_n " lives into the equation below with " t_n " where $t_n = \% \text{ time}_n$

The total weighted L_{10} life for this system =

$$L_{10w} = \frac{100}{\frac{t_1}{L_1} + \frac{t_2}{L_2} + \frac{t_3}{L_3}}$$



















Kaydon software for Reali-Slim bearings available at:

www.kaydonbearings.com

Section 4 — Separator Types, Bearing Performance and Reali-Design Software

	Page Number
■ Separator Types	101
■ Performance	104
■ Limiting Speeds	
■ Torque	
■ Axis Deviation	
■ Reali-Design	110

Overview of Separator Types Used in Reali-Slim Bearings

Code Letter*	Description	Design Features	Precautions	Material	Design
P	One piece formed ring with "snap-over" pockets.	Standard ball complement. Used in Type C and X bearings for "KA" through "KG" cross-section bearings.	Commercial type cage, not recommended for low torque applications. Consult factory for temperatures below -65°F and above 250°F.	Brass or non-metallic composite.	
R	One piece formed ring with circular pockets.	Standard ball complement. Used in Type A bearings for "KA" through "KG" cross-section bearings.	Commercial type cage, not recommended for low torque applications. Consult factory for temperatures below -65°F and above 250°F.	Brass or non-metallic composite.	
L	One piece molded ring with "snap-over" pockets.	Standard ball complement. Used in Type C and X KAA cross-section bearings.	Consult factory for temperatures below -65°F and above 250°F.	Nylon. Fiberglass reinforced.	
G	One piece molded ring with circular pockets.	Standard ball complement. Used in Type A KAA cross-section bearings.	Consult factory for temperatures below -65°F and above 250°F.	Nylon. Fiberglass reinforced.	
D	One piece machined ring with "snap-over" pockets.	Standard ball complement. Used in Type C and X bearing when low torque, lightweight or vacuum impregnation is required.	Not recommended above 250°F. Longer lead time and higher cost than "P" type separators.	Phenolic laminate.	
H	One piece machined ring with circular pockets.	Standard ball complement. Used in Type A bearing when low torque, lightweight or vacuum impregnation is required.	Not recommended above 250°F. Longer lead time and higher cost than "R" type separators. Use toroid ball spacer when possible.	Phenolic laminate.	
N	Molded strip with "snap-over" pockets	Slightly higher ball count, used in Type C and X bearings. Available for all diameters over 4 inches.	Shaft or housing protrusions can grab separator and remove from bearing. 180°F max suggested operating temp.	Nylon 12	
J	Molded strip with circular pockets	Slightly higher ball count, used in Type A bearings. Available for all diameters over 4 inches.	180°F max suggested operating temp.	Nylon 12	
X	One piece molded ring with "snap-over" pockets	Excellent for vacuums	Limited availability	PEEK	
Q	One piece molded ring with circular pockets	Excellent for vacuums	Limited availability	PEEK	
M	Formed wire strip or segmental cage with "snap-over" pockets.	Increased ball complement. Used in Type A, C, and X bearings for greater capacity (approx. 150%) and higher temperature.	Higher torque and lower speed capability than "R" type separators. Comparatively high wear rate. Requires loading notch for "C" and "X" bearings.	17-7 PH stainless steel	
W	Formed wire strip or segmental cage with "snap-over" pockets.	Used in Type C and X bearings for high temperature applications. Standard ball complement.	Higher torque and lower speed capability than "R" type separators. Comparatively high wear rate.	17-7 PH stainless steel	
F	Full complement bearing.	Max. ball complement. Used in Type C, X, and A bearings for maximum capacity and stiffness.	High torque and low limiting speed due to ball rubbing. Not recommended for dynamic applications. Loading notches are required for "C" and "X" bearings.	Steel (Per ABMA Standard 10).	
S	Helical coil spring.	Reduced ball complement. Used in Type C and X bearings for low torque and high temperature.	Increased assembly cost. Should only be considered when PTFE spacer slugs cannot be used. Slow speed and light load only.	300 Series stainless steel.	
Z	Spacer slugs.	Standard ball complement. Used in Type C or X bearings for low torque. Prevents separator wind-up.	Not recommended for temperatures greater than 250°F or speeds in excess of 500 ft/min pitch line velocity. (Example: KA040CZ0 max speed = 450 rpm).	PTFE tubing	
Z	Toroid ball spacers.	Increased ball complement. Used in Type A bearings for low torque. Prevents separator wind-up.	Not recommended for speeds greater than 500 ft/min pitch line velocity. PTFE is limited to 250°F. Vespel® is limited to 500°F.	PTFE or Vespel® SP-1 polyamide plastic.	
Z	Spacer ball.	Requires a loading notch for C and X assembly. Low speed capability. Relatively high torque.	Increased ball complement. Used in Type A bearings for low torque. Prevents separator wind-up.	Steel per ABMA Standard 10. (Spacer balls are smaller than load carrying balls.)	

Separator Types

The principal function of a bearing separator is to space the rolling elements uniformly, thereby preventing contact between them. Minute differentials in rolling element motion result from differences in individual rolling element loads and the inherent elasticity of bearing and mounting components. Without a separator some rolling elements will eventually contact each other. Due to the shape of the rolling elements and the opposite direction of motion of the contacting surfaces, a combination of relatively high contact stress and rapid motion is possible. Consequent abrasion of the rolling elements and residue of wear in the raceways affect life and torque characteristics, limiting the use of full complement bearings to slow speed applications where relatively large torque variations can be tolerated.

Kaydon separators for Reali-Slim bearings are designated by a single letter character in coded part numbers ([page 3](#)), standard P, R, L, and G separators have proved to be suitable for a wide range of operating conditions. Requirements, however, may dictate the use of different materials. This may affect capacities. For assistance in selecting Reali-Slim bearings, contact Kaydon Engineering. Operating temperatures for various separator materials are shown on [page 100](#).

Continuous Ring “Snap-over Pocket” Separator

Figure 4-1 - Pocket

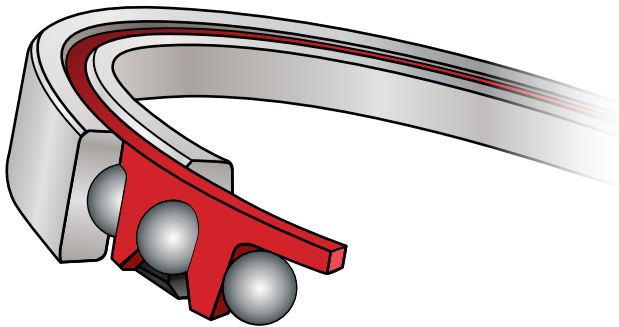

Designed for use in bearing types C and X, this style is installed after Conrad assembly of the races and balls. The tangs of the alternate “snap” pockets deform elastically to snap-over the balls for retention of the separator. Centered on the balls at room temperature, the separator becomes outer race land

riding or inner race land riding when temperatures cause differential thermal expansion or contraction.

Close control of roundness and wall thickness insures effective piloting in either case, limiting separator “whip” and friction between the separator and race lands for smooth operation.

Different materials are available for unusual operating conditions including stainless steel and non-metallics such as phenolic laminate, PTFE, and PEEK.

- Stainless steel separators are used in stainless steel bearings or high temperature applications for corrosion resistance.
- Phenolic laminate is used where light weight and/or lubricant absorption is desired.
- The “snap-over” non-metallic separator is ideal for high-speed applications of bearings too small in cross section for the two-piece riveted design (bearing Series C and lighter sections). It is also desirable in low speed, minimum torque applications.

For more information on how to use our bearings, contact Kaydon Engineering.

Orientation

It is suggested that in an application where the bearing axis will be within 45° of vertical, the bearing be positioned with separator pocket openings down or that a shoulder of the shaft or housing be extended as added assurance of retention. Sealed and shielded bearings have this orientation instruction etched on the O.D. by an arrow and the word “up” as shown below.

Figure 4-2

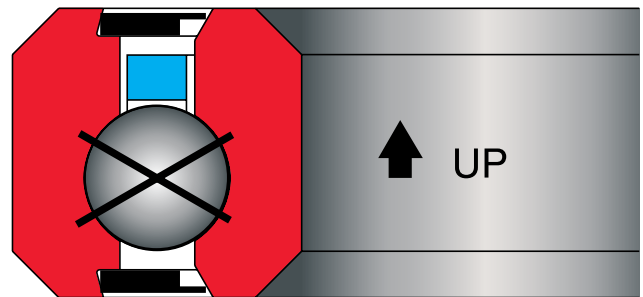

Correct bearing orientation is shown.

*Code descriptions are Position 7 of bearing identification number - see [page 3](#).

Separator Types (continued)

Continuous Ring Circular Separators

Figure 4-3 - Continuous Ring Pocket

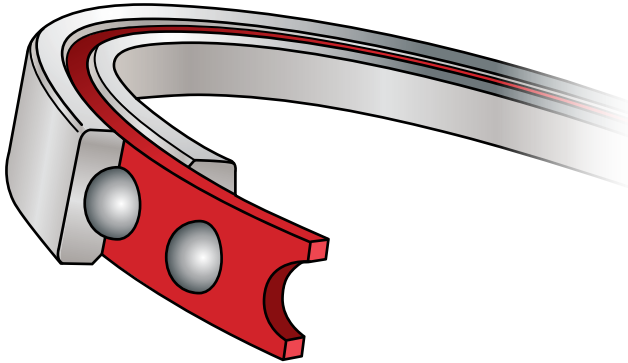
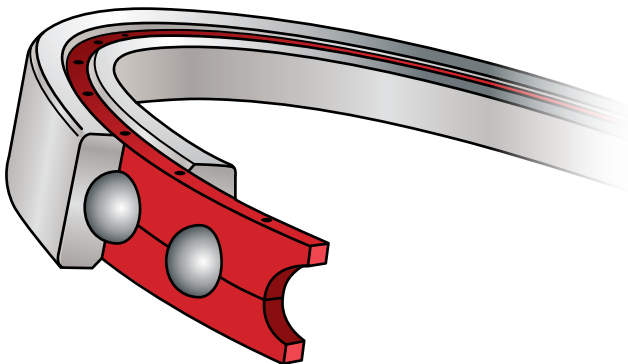

Figure 4-4 - Riveted Ring Circular Pocket



Designed for use in Type A bearings, the one-piece separator shown in Figure 4-3 is positioned around the inner race with the balls placed in pockets before the outer race is expanded thermally and dropped over the balls. This method of assembly permits the use of more balls than in the Conrad bearing Types C and X. In addition to the standard separators of brass, non-metallic composite and reinforced nylon, this style can be furnished in phenolic laminate, stainless steel, and aluminum.

Designed for use in non-standard bearings of Type C or Type X, the separator shown in Figure 4-4 is installed after Conrad assembly of the races and bearing and riveted together. Because

of the space required for rivets, use is limited to Series D and heavier sections. Usually machined all over, this style is recommended in phenolic laminate for very high speeds. Where very high strength is required, it is furnished in bronze, aluminum, or stainless steel.

As in the case of the continuous ring “snap-over” pocket separator, both of these styles are centered on the balls at room temperature, becoming either outer race land riding or inner race land riding as the temperature changes.

Segmental Separators

Segmental separators of either the ring or “snap-over” design offer advantages for certain applications.

1. When larger diameter bearings are subjected to high temperatures, expansion differentials between the separator and the races may exceed the normal clearances provided.
2. When oscillatory motion, variable loading and a vertical axis combine to cause differential ball travel with no “vacation zone,” torque may become objectionably high or erratic.

A segmental separator may consist of a one-piece open ring or it may be composed of two or more segments. Where differential expansion creates a problem, sufficient clearance is provided between the ends of the open ring or between the several segments to allow for this expansion. Where torque is of concern, the selection of the number of segments is made based upon experience. In all other respects, segmental separators satisfy the above descriptions for **Continuous Ring “Snap-over Pocket” Separators or Continuous Ring “Circular Pocket” Separators.**

Segmenting the separator imposes somewhat greater restrictions on the bearings. Maximum allowable speed of rotation is reduced due to the centrifugal force (“brake banding”) energized by the segments against the outer race lands. Also, in the case of the “snap-over pocket” style, a shaft or housing shoulder should be extended to assure retention of the separator irrespective of the operating position of the bearing. See next page.

Separator Types (continued)

Formed Wire Separator

Figure 4-5

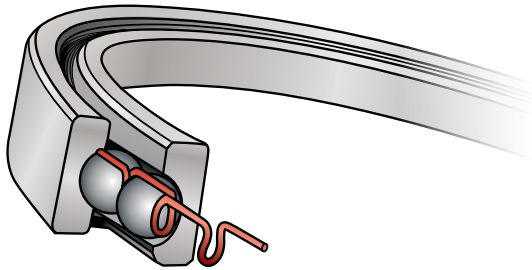

When the need exists for maximum capacity and thus the greatest possible number of balls, a formed wire separator may be used to avoid the disadvantages of a full complement bearing. It has been most successfully employed in Type A bearings, where the greater number of balls can be installed without resorting to use of a loading slot. Use in bearing Types C and X should be restricted to very low speed applications.

Comparatively high wear rate coupled with relatively light section can cause the wear life of the wire separator to be a limiting factor in the life a bearing, especially if the loads are high. However, where weight or space are at a premium and the added capacity is an important consideration, this separator may be considered a good compromise.

A bearing with a wire separator and maximum allowable ball complement has a static load capacity of 180% of the catalog static rating.

Toroid Separators

Figure 4-6A

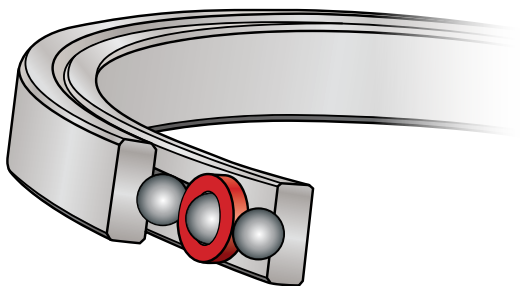

PTFE Spacer Slugs

Figure 4-6B

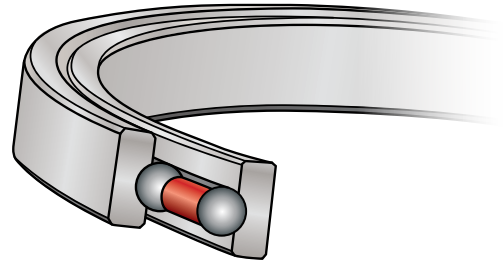

Spacer Balls

Figure 4-6C

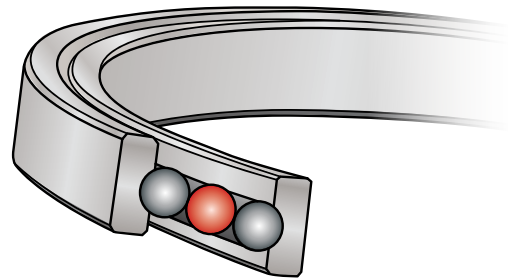

Helical Spring Separators

Figure 4-6D

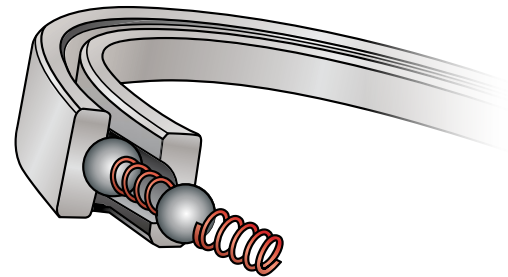

In some critical positioning applications, uniformity of torque is more important than the actual mean torque level. Specially designed toroids (Figure 4-6A), PTFE spacer slugs (Figure 4-6B), spacer balls (Figure 4-6C) or helical compression springs (Figure 4-6D) have proven in a number of such instances to be satisfactory for ball separation — by their nature they give a large amount of individual and cumulative circumferential freedom to the balls. To prevent this freedom from being abused, however, speeds must be low and loads comparatively light.

Applications involving use of these separators should be referred to Kaydon engineering for review and recommendation.

Limiting Speeds

The following limiting speed information is provided for reference only. For actual speeds, use the Real-i-Design software found on our website, www.kaydonbearings.com.

The determination of maximum safe operating speeds is largely empirical. Various complex factors play a part in limiting the speed of rotation, some of which are:

- Bearing diameter
- Ratio of bearing diameter to cross-section
- Bearing type and internal configuration
- Ratio of ball groove radius to ball diameter
- Bearing internal fit-up (diametral clearance or preload)
- Operating contact angle(s)
- Bearing precision (runouts)
- Ball separator material and design
- Precision of mount (roundness, flatness under load)
- Lubrication
- Ambient temperature and provision for heat dissipation
- Seals
- Loads
- Life requirement

While precise speed limits cannot be set, experience in actual applications and in the Kaydon test laboratories can serve as a basis for setting general limits. Figure 4-9 takes into account some of the factors and assumes proper installation and adequate provision for heat dissipation. These limits are based upon achieving the full service life of 1,000,000 revolutions. If a shorter life is acceptable, higher speeds may be tolerated, except for bearings using formed wire and helical spring separators.

For speeds near or over the limits in the table, special attention must be given to lubrication and heat. Greases should be of types specially formulated for high speed bearings. Frequency of regreasing must be adequate to insure presence of lubricant at all times. If oil is used, viscous drag should be minimized by controlling the level, using slingers and/or metering small amounts as a liquid or mist. Windage effects at high speeds can make the introduction of oil to the critical surfaces very difficult,

and the design of the lubrication system then becomes important. Please consult lubrication manufacturer.

Generally speaking, operating temperature will be limited by the allowable maximum temperature for the lubricant. If, however, bearing temperature is expected to exceed 250°F for extended periods, the bearings should be given stabilization treatment by Kaydon. This treatment will permit operation at temperatures up to 400°F.

While maximum temperature is important, consideration must also be given to possible temperature differential across the bearing. Generally, heat is lost through the housing at a higher rate than through the shaft. The housing fit and the bearing internal clearance before installation must be sufficient to allow for this as well as for the shaft fit if the necessary running clearance is to be realized.

Examples of Limiting Speed Calculations

Example 1 (Standard Bearing)

Limited speed calculation for bearing part number KG040XP0.

Conditions: light thrust loads (<20%), grease lubrication.

From Figure 4-7: slinness symbol = I

From Figure 4-8: derating factor = 1.0

From Figure 4-9: Type X; Separator P; Grease; Class 1; Charted figure = 9

$$\text{Calculation: } N = \frac{(1.0)(9)(1000)}{4} = 2,250$$

Example 2 (High Performance Bearing)

Limiting speed calculation for bearing number KD100AH6.

Conditions: loading at 25%, oil lubrication

From Figure 4-7: slinness symbol = II

From Figure 4-8: derating factor = 0.9

From Figure 4-9: Type A; Separator H; Oil; Class 6; Charted figure = 32

$$\text{Calculation: } N = \frac{(0.9)(32)(1000)}{10} = 2,880$$

Limiting Speeds (continued)

Figure 4-7 - Slimness Symbol (S₂)

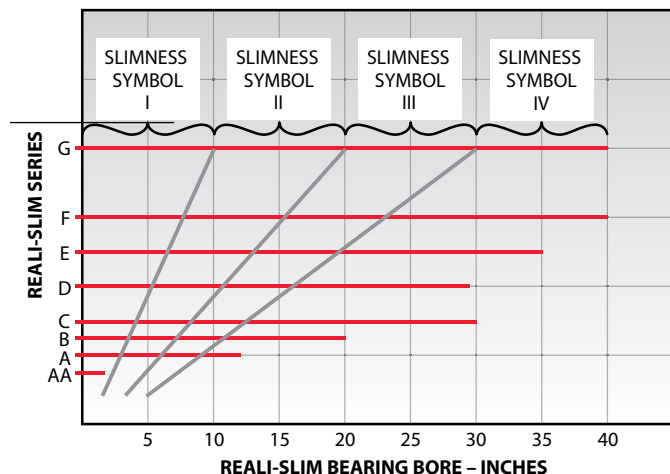

Limiting Speeds for Unsealed, Lightly Loaded Reali-Slim Ball Bearings

$$\text{Limiting Speed (N)} = \frac{(F_f) (C_f) (1000)}{D}$$

where:

D = Bearing bore in inches

N = RPM

Figure 4-8 - Derating Factor (F_f)

For bearings loaded to following percent of dynamic rating	Multiply DN values by following factors
20	1.0
33	.9
50	.8
67	.7
100	.5
150	.2

Figure 4-9 - Charted Figures (C_f)

Bearing Type	Load Conditions	Separator Type	PRECISION CLASS AND LUBRICATION																			
			CLASS 1, 3 & 4								CLASS 6											
			GREASE				OIL				GREASE				OIL				OIL MIST			
Slimness Symbol from Figure 4-7			I	II	III	IV	I	II	III	IV	I	II	III	IV	I	II	III	IV	I	II	III	IV
C with Diametral Clearance	Radial	P, L, X	15	12	9	6	21	18	15	12	21	18	15	12	27	24	21	18	30	27	24	21
		K	20	16	12	8	28	24	20	16	28	24	20	16	36	32	28	24	40	36	32	28
A Spring Loaded or Axially Adjusted	Radial and/or Thrust	R	15	12	9	6	21	18	15	12	21	18	15	12	27	24	21	18	30	27	24	21
		G, H	20	16	12	8	28	24	20	16	28	24	20	16	36	32	28	24	40	36	32	28
		M	8	6	5	3	11	9	8	6	11	9	8	6	14	12	11	9	15	14	12	11
X with Diametral Clearance	Thrust Only	P, L, X	9	8	7	6	11	10	9	8	11	10	9	8	14	12	11	9	15	14	12	11
	Radial Only or Combined Loading	P, L, X	3.0	2.5	2.0	1.5	4	3.5	3	2	4	3.5	3	2	4.5	4	3.5	3	5	4.5	4	3.5

Torque Considerations

Torque, as it applies to bearings, is defined as the moment required to turn the rotating race with respect to the stationary race.

Usually the torque requirement of a ball bearing is only a small part of the demand of a mechanical system. In many Reali-Slim bearing applications, however, masses and consequent inertias are slight and the amount of work being done is not great. In such cases, it may be important to know as accurately as possible how much turning effort must be provided.

Many factors contribute to the resistance to rotation of a lightly loaded anti-friction bearing, and most of this resistance comes from the more unpredictable ones—separator drag; viscous drag of the lubricant; minute deviations from true geometry in the balls, race ways, and mounting surfaces of bearing, shaft, and housing; internal fit-up of the bearing; and the presence of contaminants.

Bearings can be furnished to a maximum torque level specification.

In the selection of the lubricant and lubricating system, their effects on torque should be kept in mind. To be considered are operating temperatures; speeds of rotation; type, viscosity and quantity of lubricant. All are major factors in determining lubricant drag. Please consult lubrication manufacturer.

In tolerancing the shaft and housing it is important to set limits for out-of-roundness and out-of-flatness of the bearing seats. For

normal requirements a good rule of thumb is to use the bearing radial and axial runout tolerances as the respective limits. For critical torque applications, closer tolerances should be specified since even a very small amount of localized internal preload (negative clearance) will create surprisingly large ball loads and consequent high torque. Where torque must be minimized it is important to limit out-of-roundness of housing or shaft to values which will insure against complete loss of internal clearance.

Cleanliness is extremely important in maintaining uniformity of torque as well as a low level of torque. Very small amounts of microscopic particles of lint, dust, and other common contaminants can cause bearing torque to vary several hundred percent in just a few degrees of rotation. For this reason bearings should be kept in their original unopened package until time for installation. Every effort should be made to protect them from foreign matter, whether or not torque is critical.

The accompanying charts show approximate torque levels of Reali-Slim bearings under stated conditions. Estimates can be furnished for more unusual situations. Information submitted should contain all operating conditions of load, speed, lubricant, and environment (including temperature), together with a print of the intended mounting, showing materials and radial sections. If a limit has been set on permissible system error in terms of axis deviation — radial translation, axial translation, or angular rotation ([page 108](#)) — this information should also be submitted.

Additional processing is used to achieve the lowest possible torque levels. High precision races and balls, super-finished ball tracks, and precisely set internal fit-ups assure optimum performance.

- Low-torque ball separators
- Clean-room assembly
- Factory-lubricated bearings
- ABMA Grade 10 balls
- Super-finish ball track

Materials

Races	AISI 52100 (Precision Class 6)
Balls	AISI 52100 (Grade 10)
Cage (Type A)	PTFE or Vespel® toroid ball spacers
Cage (Types C, X)	Slugs

Starting Torque vs. Load

Torque curves for mounted Reali-Slim bearings can be calculated and provided by Kaydon Product Engineering

Figure 4-10

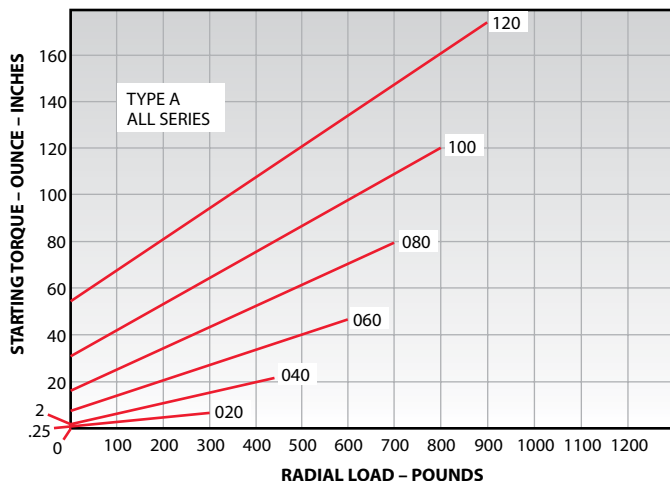

Figure 4-12

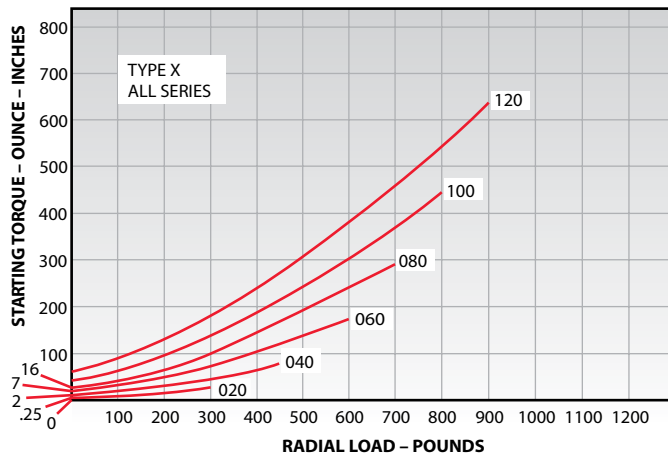

Figure 4-11

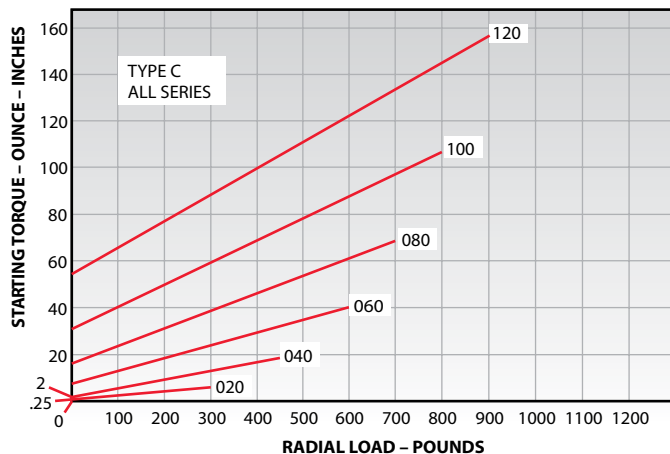
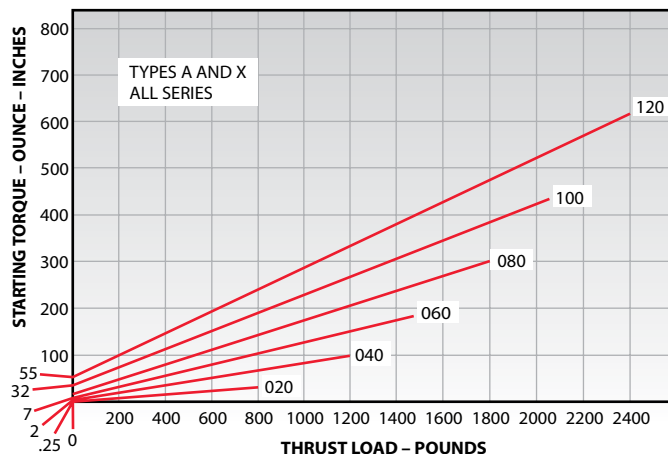

Figure 4-13



Notes Applying to These Charts

1. Values shown are statistical ratings* based on:

- Kaydon Precision Class 1 bearings with some internal clearance remaining after installation
- A rigid mounting, round and flat within respective radial and axial bearing runout limits
- Light oil lubrication
- Room temperature

2. Running torque at speeds up to 10 RPM usually averages from 25 to 50% of starting torque, and increases with increasing speed to as much as 200% at maximum allowable diametral clearance (page 109).

3. Interpolate for intermediate sizes.

4. Curve number indicates bearing bore in tenths of an inch.

*Usually not more than 10% of a group of bearings will have torque demands higher than those shown.

Bearing Axis Deviation Due to Clearance and Deflection

Real-Slim bearings are often used in applications where the position of a rotating part relative to the stationary structure is critical. Knowledge of the displacement of the axis of rotation and the factors contributing to it are thus important.

The axis of rotation can be displaced from its true position in three ways—radially, axially, and angularly. These deviations are referred to as radial translation, axial translation, and tilt (angular rotation) respectively.

In addition to the obvious effects of bearing runout, total deviation of bearing axis in any one of the above conditions is due to the effects of bearing diametral clearance and elastic deflection (deformation) at the ball or roller contacts. The diametral clearance after installation changes due to the combined effects of external fitting practice, differential thermal expansion or contraction of the bearing races and mounting structures, and relative rigidity of the races and mating parts.

Elastic deflection at the ball or roller contacts results from the externally applied bearing loads and is influenced by ball or roller diameter, race groove radius, raceway diameters, and contact angle.

The following three equations are given to aid in determining displacement. The internal diametral clearance (DC) must be calculated or approximated. The remaining independent variables can be calculated with Kaydon's easy-to-use Real-Design software. (see [pages 110-111](#)).

$$RT = RD + \frac{DC}{2}$$

$$AT = AD + \frac{AC}{2}$$

$$AR = MD + AC/PD$$

Where:

RT = Radial Translation – in inches

AT = Axial Translation – in inches

AR = Angular Rotation – in inches/
inch or radians

RD = Radial deflection due to radial load – in inches

AD = Axial deflection due to axial load – in inches

MD = Moment deflection due to moment load – in inches/
inch or radians

DC = Diametral clearance – in inches

AC = Axial clearance – in inches

PD = Pitch diameter $\frac{O.D. + Bore}{2}$ – in inches

The equations may be used in applications where the radial, axial, or moment load is applied singly or where one type of loading predominates. For assistance in selecting Real-Slim bearings, contact Kaydon Engineering.

Computer-generated reports and graphs for Real-Slim bearings are available from Kaydon engineering and from our Real-Design computer software, available for download at www.kaydonbearings.com.

Axial Clearance vs. Diametral Clearance

Figure 4-14

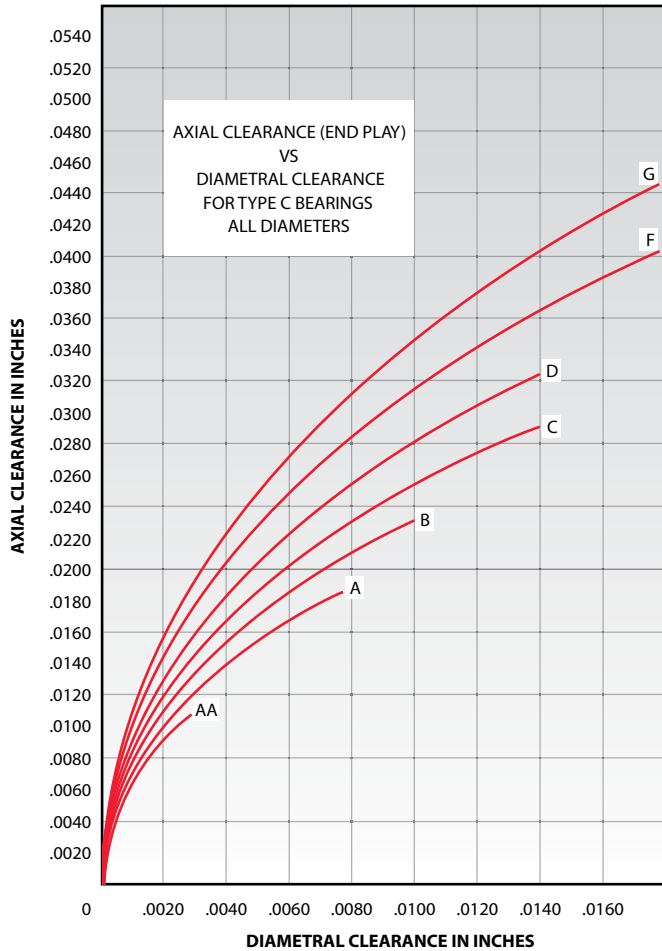
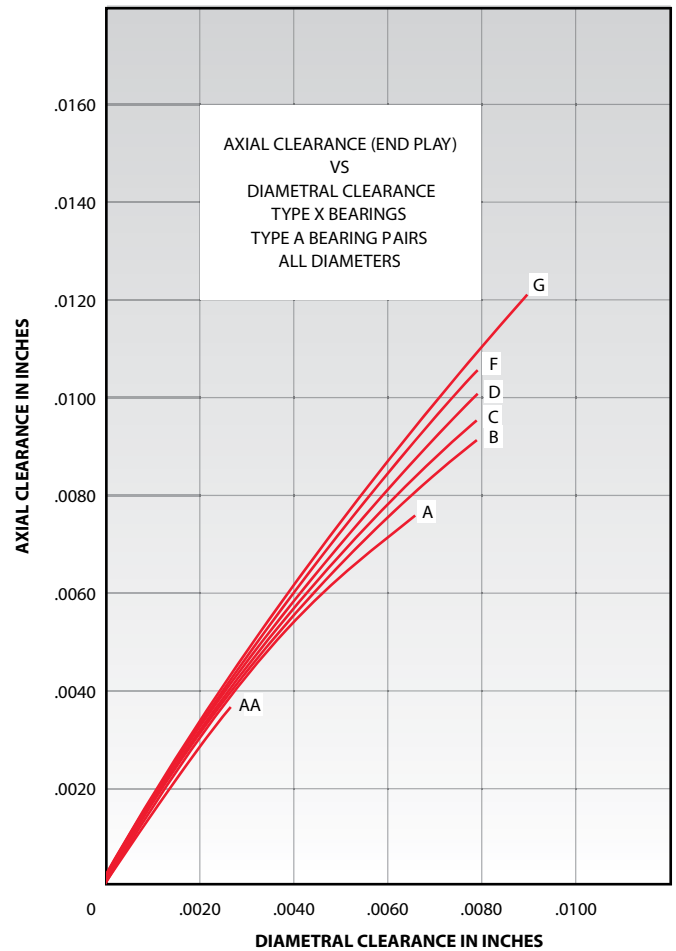

Figure 4-15



CONTACT Kaydon at —
 Kaydon Bearings • Muskegon, Michigan 49443
 Telephone: 231-755-3741 • Fax: 231-759-4102

Need Service Fast?
1-800-514-3066
www.kaydonbearings.com



Simplify Your Bearing Selection With Free Reali-Design Software

Reali-Design software makes it easy to select the best Reali-Slim bearing for your application, and is exceptionally easy to use. Here is a quick orientation.

After a simple registration process at our website, www.kaydonbearings.com, go to the Resources tab at the top our home page. In the drop-down menu, choose "Reali-Design engineering software" to download either Reali-Design (for inch series bearings) or Reali-Design MM (for metric series bearings). Both give you the option to work in U.S. units (inches and lbs.) or SI units (mm and Newtons).

When the start-up screen appears, click on "Reali-Design Bearing Selection" or wait five seconds. Next, you can choose to work in U.S. units (inches and lbs.) or SI units (mm and Newtons). You may toggle between units any time, and the background color changes to remind you which units you are using.

Designers unfamiliar with Reali-Slim bearings will find the *Introduction* and *Bearing Training* sections useful. The flow chart below starts with the key question for using the program: "Is the Kaydon Part Number Known?"

If the answer is "Yes," you simply enter the number and click the "Next" button. The Kaydon part number will appear in red, underlined.

If you don't know the Kaydon part number, the software will help you select one. Input key parameters and you'll see a list of appropriate Reali-Slim bearings. Criteria include:

- Envelope size
- Loads
- Thumbnail image
- Matching bearing selections
- Bearing L_{10} life
- Limiting speed

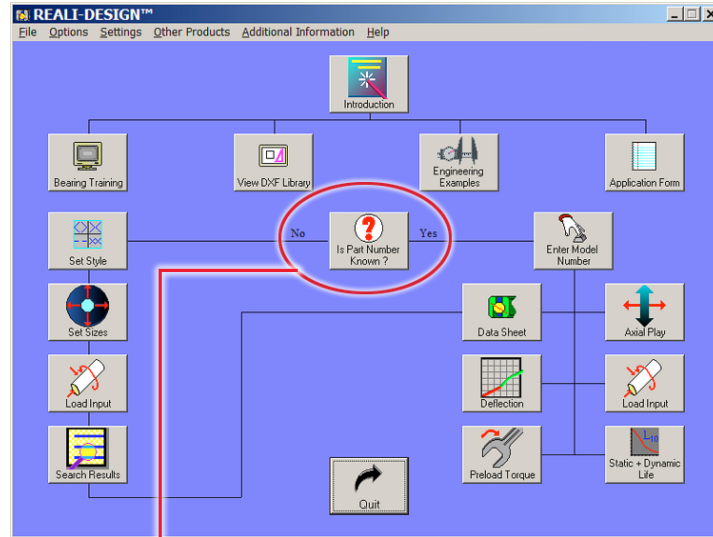

A user-friendly flow chart starts the search, either for a known part number or for bearings that will meet your search criteria.

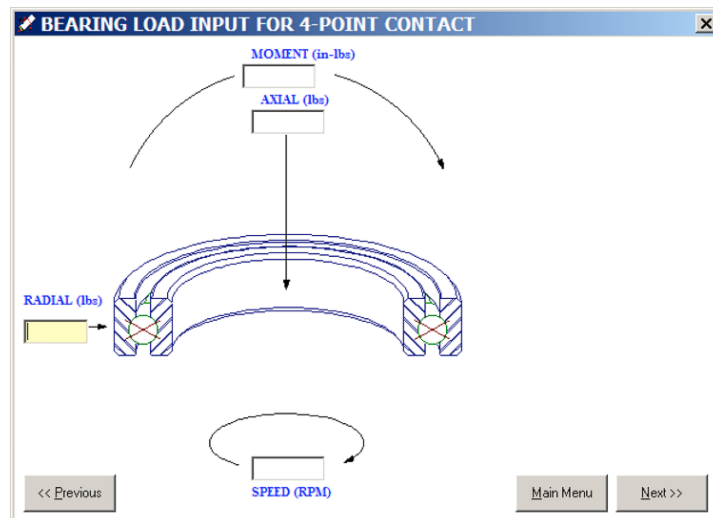
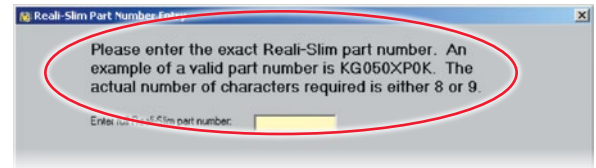
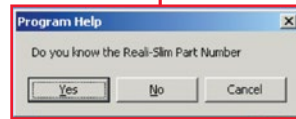

Simplify Your Bearing Selection With Free Reali-Design Software (continued)

Reali-Design will graph key performance factors such as:

- starting torque (estimated, unmounted, and adjustable to your shaft and housing)
- radial deflection
- axial deflection
- moment deflection

The deflection graphs are based upon your selected preload and application loads, and can be saved or printed. Reali-Design software lets you toggle back and forth between these and the Torque vs. Preload data to determine the recommended Kaydon bearing preload for your application. It will also project bearing life for you, in revolutions or hours. All you have to do is input the anticipated load.

For a savable Word document with the most-requested parameters for that part number — dimensions, part number breakdown, tolerances, recommended shaft and housing fits, static and dynamic capacity ratings, number of balls and limiting speeds — click on the Data Sheet box.

In countless applications around the world, Reali-Design and Reali-Design MM software are making the job of the design engineer easier. And they're free! To get your copy, go to the Kaydon website or call Kaydon Bearings at 800-514-3066.

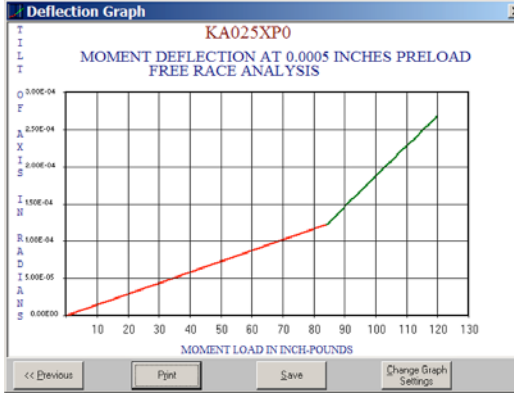

The software will graph key performance data for you (e.g., moment, radial or axial deflection).

TECHNICAL DATA SHEET
JA025XP0

Will Clear .025
Max. Fillet
4 Exterior

0.2500 ±.0005

Inner Race
Axial Runout
.00050 Max.

Outer Race
Axial Runout
.00050 Max.

Drawing Scale: 1. All Dimensions in Inches
33 Balls, Ø.125 Nominal
Approximate Weight = .120 lbs.

Part Number Detail

J = Vacuum Degassed 52100 Steel W/ 2 Seals
A = .250 x .250 Cross Section
0 2 } = Bore Size x 10 in Inches
5
X = 4-Point Contact Ball Radial Bearing
P = Standard Snap-over 1 Piece Ring
0 = Precision Class 1
Standard .0012 - .0022 Clearance

Standard Recommended Fits

If Rotating Shaft		If Stationary Shaft	
Ø Shaft	Ø Housing	Ø Shaft	Ø Housing
2.5000	3.0000	2.4994	2.9995
2.5006	3.0005	2.4988	2.9990

Static and Dynamic Ratings		
	Static	Dynamic
Radial	835 lbs.	583 lbs.
Axial	2,087 lbs.	907 lbs.
Moment	1,148 in-lbs.	601 in-lbs.

Capacities do not apply simultaneously, and are the 'P' separator. The Static ratings are based on onset of permanent non-detrimental deformation. Dynamic rating is based on 1,000,000 revolutions L10

Maximum Limiting Speed vs. Load Level

AVAILABLE FROM STOCK
For More Information, call Kaydon at (231)-755-3741
Kaydon Reserves the Right to Change Specifications and Other Information Without Notice
Kaydon® REALI-DESIGN ver. 2.70 Saved 8/28/2014 8:30:10 AM

Key parameters, like desired bearing load, are easy to input. A click on the "Data Sheet" box produces a Word document with a cross-section, dimensions and performance data.

Section 5 — Mounting, Installation and Maintenance of Real-Slim Bearings

	Page Number
■ Mounting	113
■ Inspection and Installation Procedures	118
■ Lubrication and Maintenance	120

Mounting

Introduction: Reali-Slim thin section ball bearings have a cross-section thickness that is much thinner than standard bearings of the same diameter, and are therefore more sensitive to shaft and housing fits. Proper mounting is essential to make sure that the bearing functions as intended. There are a number of factors to consider when mounting a bearing, including: bearing style and orientation, the direction and magnitude of the applied loads, allowable free play in the bearing, the maximum allowable torque, shaft and housing materials, operating temperature, and which ring is rotating.

Radial (Type C) Bearings: Radial bearings are typically used when the applied loads are predominantly in the radial direction. If two bearings are used on opposite ends of a long shaft, then one of the bearings should be allowed to float in the axial direction (see Figure 5-1). This is done so that thermal expansion of the shaft or housing does not induce an axial (thrust) force into the radial bearing.

Figure 5-1

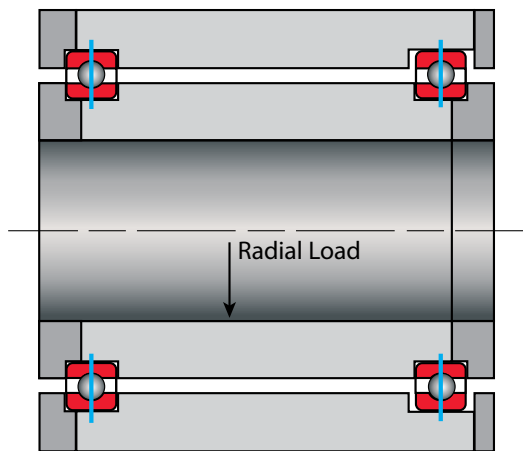

The recommended shaft and housing sizes for radial bearings are found in the tolerance tables. Kaydon generally recommends a light press fit between the bearing and either the shaft or housing, whichever side is rotating. A slight amount of clearance is recommended for the non-rotating (stationary) side. Most radial bearings are supplied with an internal diametral clearance. Using the recommended fits assures that the bearings will not become radially tight after installation, which could affect bearing life and performance.

Please note that the recommended fits apply only to bearings with “standard” clearance, which is also shown in the tolerance

tables. They also apply only to steel shafts and housings, or room temperature applications. If dissimilar metals are used, then the fits will change with temperature. This could cause the bearing to become radially tight, leading to excessive friction torque. When bearings are supplied with a diametral preload, a slight clearance is recommended for both the shaft and housing.

Kaydon also recommends that face clamps (See Figure 5-2) be used with all bearings. The user should not rely solely on a press fit to hold the bearing in place.

Figure 5-2

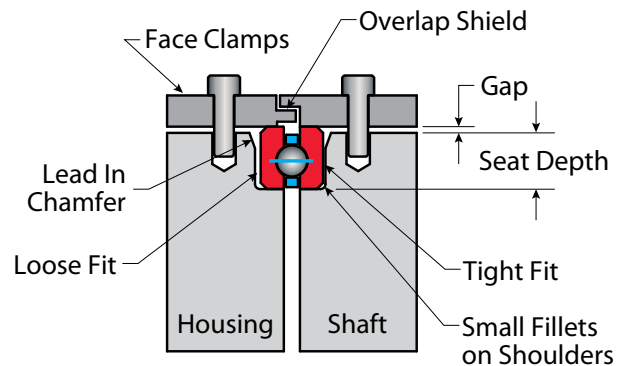

Four-Point Contact (Type X) Bearings: Four-point contact bearings are used when there is an axial (thrust) applied load or some combination of radial, thrust and moment loads. If two bearings are used on the opposite ends of a long shaft, the second bearing should be a radial (Type C) bearing, and it should be allowed to float as shown in Figure 5-3. Kaydon does not recommend using two four-point contact bearings on the same shaft.

Figure 5-3

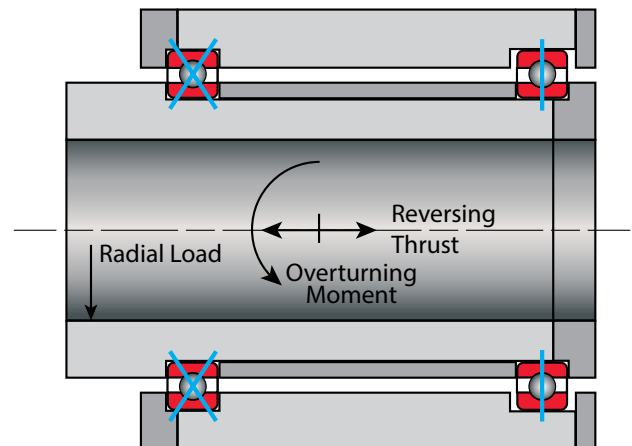

Mounting (continued)

Recommended shaft and housing sizes for four-point contact bearings can be found in the tolerance tables. As with radial bearings, these fits only apply to bearings supplied with the standard clearance, and to steel shafts and housings or room temperature applications. Four-point contact bearings can also be supplied with a diametral preload. Where preloaded bearings are used, there should be a slight clearance to both the shaft and housing.

A single four-point contact bearing is capable of taking an axial (thrust) load in both directions. It is also capable of taking radial and moment loads. However, this type of bearing typically has higher friction than a radial (Type C) or an angular contact (Type A) bearing of the same size. Therefore, for torque-sensitive and high-speed applications, duplex pairs of angular contact bearings are generally used in place of a single four-point contact bearing.

Angular Contact (Type A) Bearings: Angular contact ball bearings can take an axial (thrust) load in only one direction, and therefore are almost always used in pairs. They can be used in either a back-to-back (DB) arrangement or a face-to-face (DF) arrangement, as described in the Bearing Selection section on page 91. Angular contact pairs are normally used with some amount of axial preload to remove all free play and increase stiffness. Angular contact bearings can be purchased as matched pairs where the axial preload is set by the factory, or as individual bearings where the axial preload is set during installation.

When angular contact bearings are purchased as a matched pair — called a “duplex pair” — the inner and outer rings simply need to be clamped in place as shown in Figure 5-4. For bearings with an axial preload, there should be a slight clearance between the bearing and both the shaft and housing. If a third bearing is used on the opposite end of a long shaft, it should be either a single radial or a face-to-face (DF) pair. It should also be free to float in the axial direction, (see Figure 5-4). Kaydon does not normally recommend using two back-to-back (DB) bearing pairs on the same shaft.

Figure 5-4

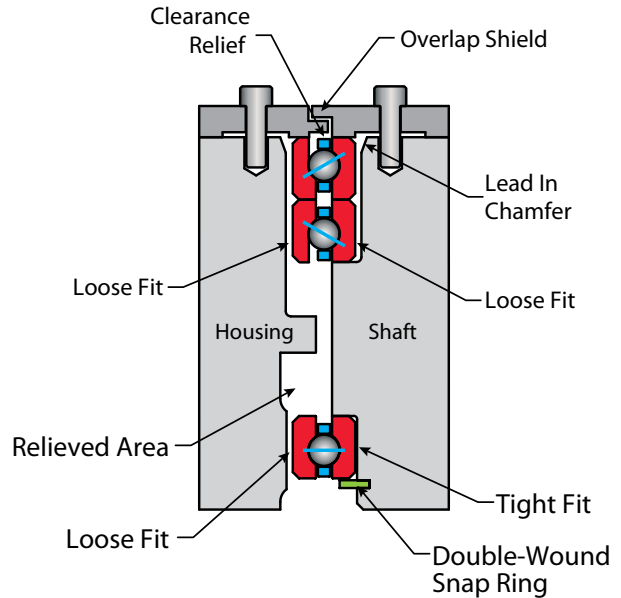

Back-To-Back (DB) Mounting: If angular contact bearings are purchased as individual bearings, the axial preload needs to be set during installation. If the bearings are used in a back-to-back (DB) arrangement, the preload is set by pressing the inner rings of the two bearings toward each other. The axial preload is set using shims, as shown in Figure 5-5.

Figure 5-5

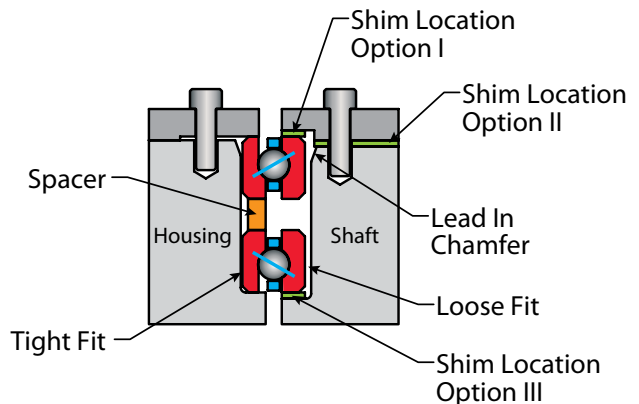

Mounting (continued)

If the thrust load is applied in only one direction, then the bearings can also be preloaded using a wave spring, as shown in Figure 5-6.

Figure 5-6

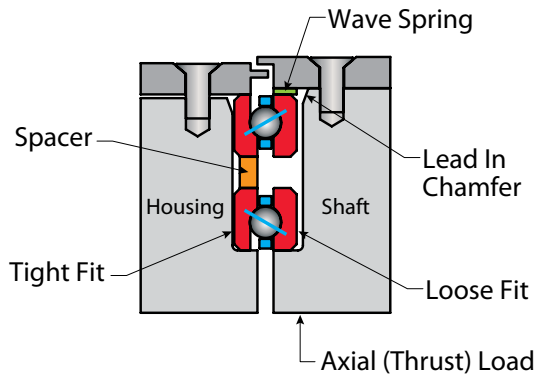

For a back-to-back (DB) mounting, Kaydon typically recommends using a slight press fit between the bearing OD and the housing. A clearance fit is required between bearing and shaft so the inner rings are free to move in the axial direction. The recommended shaft and housing sizes are shown in the tolerance tables. Please note that these fits are for steel shafts and housings or for room temperature applications. If dissimilar metals are used, then the fits will change with temperature. In that case looser fits may be advisable to prevent excessive friction torque at high and low temperatures.

The life and load-carrying capacity of a pair of angular contact bearings under an applied moment load can be increased by spacing the bearings further apart (Fig. 5-7). The angular deflection (tilt) of the shaft under an applied moment also decreases as the spacing increases. However, the bearings can become more sensitive to differential thermal expansion if the shaft and housing are different materials or if they operate at different temperatures.

Figure 5-7

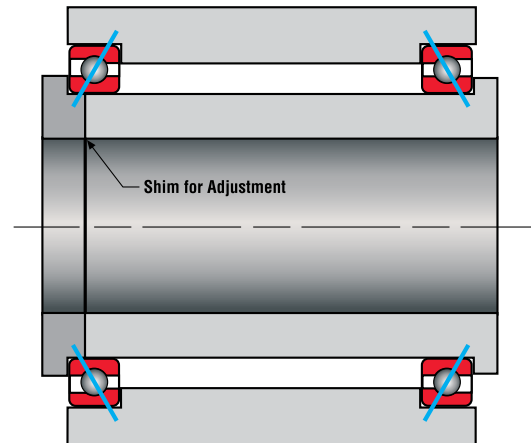

Face-To-Face (DF) Mounting: In a face-to-face (DF) mounting, the preload is set by pressing the outer rings toward each other (Fig. 5-8). The preload can also be set with shims or wave springs. For this type of mounting a slight press fit is used between the bearing I.D. and the shaft. A slight clearance is required between the bearing O.D. and housing. The recommended shaft and housing sizes for DF mounting can be found in the tolerance tables. As with the DB mounting, if dissimilar metals are used then looser fits may be necessary to prevent excessive friction torque at high and low temperatures.

Figure 5-8 - Face to Face

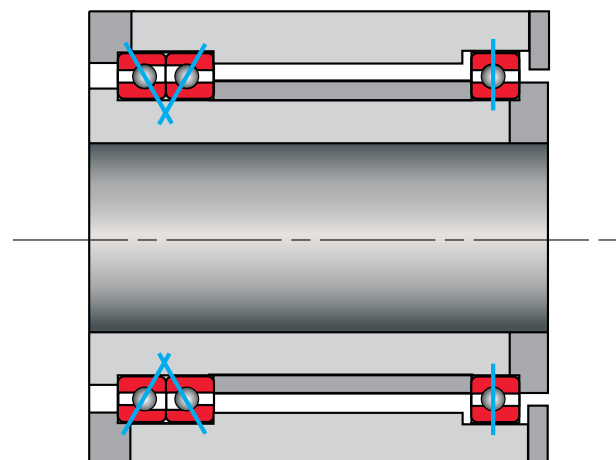

Mounting (continued)

General Recommendations

Orientation: Kaydon recommends that radial (Type C) and four-point contact (Type X) bearings that use a “snap-over” or “crown” type ball separator be mounted with the solid side of the separator facing up and the pocket openings facing down if the shaft orientation is within 45° of vertical. These bearings are marked with an “UP” arrow to show proper orientation. For horizontal shafts, there is no preferred orientation.

Figure 5-9

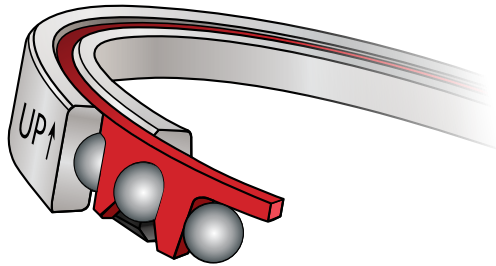

Single angular contact (Type A) bearings can only take an axial (thrust) load in one direction. The outside diameter of these bearings is marked with an arrow and the word “THRUST” to indicate the direction that a thrust load can be applied to the outer ring.

When these bearings are mounted in a back-to-back (DB) arrangement, the arrows should point away from each other. In a face-to-face (DF) arrangement, the arrows should point toward each other.

Figure 5-10

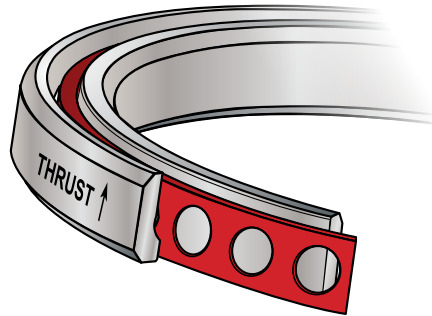

Angular contact bearings purchased as a matched (duplex) set will have a “V” marked across the O.D. and I.D. of both bearings.

During installation these “V” marks should be aligned with each other. (For vertical shafts it does not matter whether the “V” is facing up or down.) The “V” marks are located at the high point of radial runout. These can be matched to the low point on the shaft and housing to reduce the assembled runout.

Figure 5-11

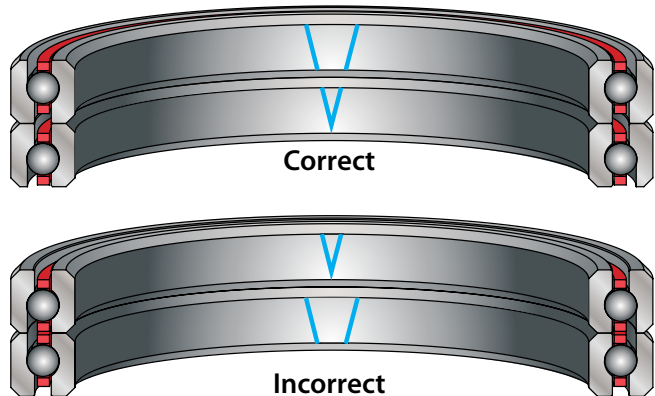

Mounting (continued)

Shaft and Housing Tolerances: Since their cross-sections are much thinner than standard bearings of the same diameter, Reali-Slim thin section ball bearings are very sensitive to shaft and housing geometry. After installation the bearing tends to take the shape of shaft and housing, so the roundness of the shaft and housing is very important, as is the flatness of the bearing seats. Therefore, Kaydon recommends the following:

- A)** The flatness tolerance for the bearing seat in the outer housing should be the same as the axial runout of the outer ring of the bearing.
- B)** The roundness tolerance for the outer housing should be the same as the radial runout of the outer ring of the bearing.
- C)** The roundness tolerance for the shaft should be the same as the radial runout of the inner ring.
- D)** The flatness tolerance for the bearing seat on the shaft should be the same as the axial runout tolerance of the inner ring.

Figure 5-12

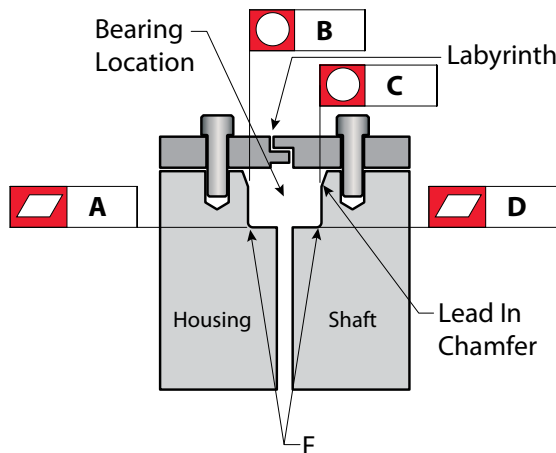

Both the shaft and the housing should have a shallow lead-in chamfer for ease of assembly. The fillet radii at the corner of the bearing seats should be smaller than the chamfer on the bearing (dimension “F” in the bearing tables). Where interference fits are used, heat or cold should be used to increase clearance and ease assembly. Allow the assembly to return to room temperature before tightening any fasteners.

If a press fit must be used, then Kaydon recommends applying uniform pressure over the entire face of the bearing. **Always press on the ring with the interference fit.** For example, if a press fit is used between the bearing and the shaft, then press on the inner ring, not the outer. **WARNING – Never press across the races, as this can damage the bearing.**

Preload: The optimal preload for any bearing depends on the application. As the preload increases, the amount of deflection under load is reduced (see Figure 5-13) and the bearing stiffness and natural frequency increase. However, increased preload also leads to higher friction torque. Kaydon’s free Reali-Design software can be used to calculate the amount of deflection under an applied load for various amounts of preload. This tool can also be used to calculate the amount of preload needed for any given application.

Figure 5-13

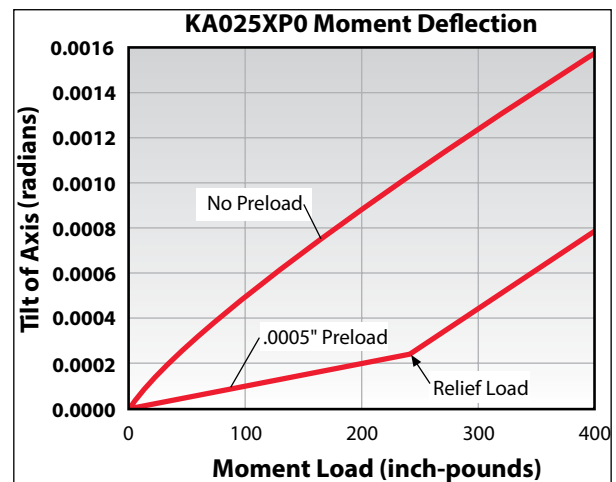

Clamp Rings: Kaydon recommends that face clamps be used with all bearings. The user should not rely solely on a press fit to hold the bearing in place. Overlapping the clamp rings to form a labyrinth shield, as shown in Figure 5-2, is recommended. This helps keep lubricant in the bearing and contamination out. For bearings used in harsh environments, external seals are recommended.

To provide a uniform clamping force, a large number of small fasteners is preferable to a few large ones. The fasteners should be tightened in a “star” pattern to evenly distribute the clamping force.

Lubrication: Standard open bearings are shipped with preservative oil that is not intended to be a working lubricant. Prior to installation, the bearings should be cleaned and then lubricated with an oil or grease suitable for the loads, speed, temperature, and environment.

Inspection and Installation Procedures for Reali-Slim Thin Section Bearings

Inspection

The unique proportions of Reali-Slim bearings make some of the usual gaging practices impractical. Since very light pressure is sufficient to deflect the thin rings, conventional two-point measurement of bearing bore and outside diameter must not be used. Air gages of the open jet type, or other proximity devices, must be used to hold error from distortion to an acceptable level. Measurements must be made at enough points to yield a true average size, which may not be the mean of the maximum and minimum measurement. A Reali-Slim bearing may be out-of-round in the free state^① more than the ABMA tolerance for its precision class. This presents no problem since the races will conform readily to a round shaft diameter and housing bore.

To determine the true runout of each race, by excluding the effect of out of roundness, measurement is made of variation in individual wall thickness. This is schematically illustrated in Figure 5-14. The indicator must contact the raceway at the ball or roller contact, and must be properly positioned for the particular runout (axial or radial) being checked.

Measurement of Radial Runout of Type C Inner Race

Figure 5-14

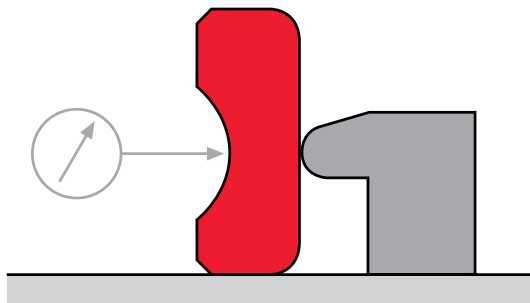

Diametral clearance of Reali-Slim bearings is controlled by selective assembly of races and balls following measurement with gages specially designed for this purpose.

Standard inspection and quality control procedures at Kaydon meet the requirements of government procurement agencies and major aerospace industries. However, a certificate of compliance to specifications can be furnished if required.

Installation

To realize the potential accuracy and long life of a Reali-Slim bearing, it is important that the installation be properly done in a clean environment. Cleanliness is vital to satisfactory bearing performance. Work surfaces and tools must be free of dirt, chips, and burrs. Disposable wipers or clean, lint-free cloths should be used.

Under no circumstances should a bearing be used as a gage during grinding or machining of mating parts. Just a few grains of grinding grit or chips of metal (soft as well as hard) can seriously damage the precise geometry and finishes of bearing raceways and rolling elements, and are nearly impossible to remove from an assembled bearing.

The shaft and housing should be thoroughly cleaned, special attention being given to holes and crevices which could hold dirt, chips, and cutting oil. Unfinished surfaces of castings should be painted or otherwise sealed. The mounting surfaces for the bearing must be carefully checked, cleaned, and lightly oiled to ease fitting and minimize danger of scoring. Housing bore, shaft diameter, shoulder squareness, and fillet sizes should all be verified.

The bearing should not be removed from its protective package until this preparation is complete and it is time for installation.

^① As explained in ABMA Standard 26.2

Inspection and Installation Procedures for Reali-Slim Thin Section Bearings (continued)

Interference fitting any bearing to the shaft or housing must be carefully done to avoid damage to the bearing. For Reali-Slim bearings, the use of temperature difference to expand the outer member is recommended to minimize or eliminate the installation force necessary. To calculate the differential required, use a coefficient of expansion of .000007 inch per inch per degree F for AISI 52100 steel races and .0000056 for AISI 440C races. For a Kaydon Precision Class 1 bearing of 2" bore to be fitted to a steel shaft, the differential required to eliminate all interference between a maximum diameter shaft and minimum diameter bearing is 90°F; for a 4" bore it is 60°F. Either dry heat or hot oil may be used. Electrical resistance tape is convenient for the large bearings. Care must be taken to avoid overheating the bearing. Do not exceed 250°F.

If pressure is necessary, an arbor press should be used with a suitable pusher to apply the force to the full face of the ring being press fitted — never through the bearing, as damage will be done to the balls and raceways.

All duplexed bearings are marked with a single "V" on the bores and outside diameters to indicate the proper relative circumferential position of inner and outer races. This "V" is located at the high points of race eccentricity so that these may be placed at the low points of shaft and housing eccentricity for the canceling effect.

Figure 5-15

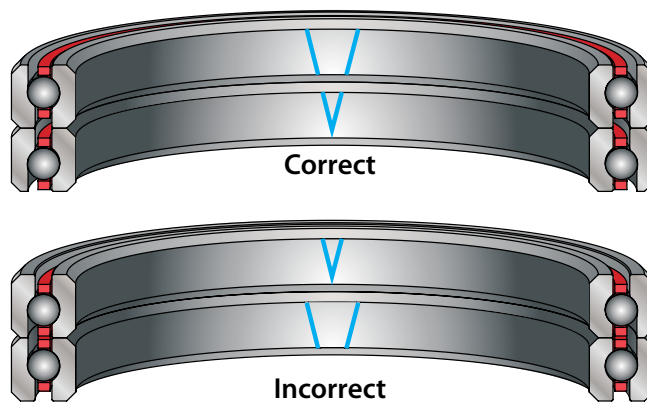

After mounting, the bearings must be given continued protection from contamination until the assembly is closed. Adherence to these procedures will assure a successful installation.

If it is necessary to return a bearing to Kaydon, it should be coated with protective oil and wrapped the same as when shipped from the factory to prevent damage during transit. If bearings are being returned after use for a failure analysis, they should be returned in the as removed condition, since the condition of the part (cleanliness, lubricated condition, etc.) will provide important data for failure analysis.

CONTACT Kaydon at —

Kaydon Bearings • Muskegon, Michigan 49443
Telephone: 231-755-3741 • Fax: 231-759-4102



Need Service Fast?

1-800-514-3066

www.kaydonbearings.com



Lubrication and Maintenance of Reali-Slim Thin Section Bearings

The lubricant in an anti-friction bearing serves to reduce friction and wear between moving parts, to dissipate heat, and to prevent corrosion of critical surfaces. Kaydon recommends the selection of the proper lubricant be based on an evaluation by the system design engineer of the operating conditions, including at a minimum: rotational speed, type and magnitude of loads, and ambient temperature.

The three types of lubricant commonly used are oil, grease, and dry film or surface treatment.

Oil normally provides more complete lubrication. Because of its liquid state, it provides better coverage of the critical surfaces and assists in dissipating heat more readily, the latter being especially true when circulation and cooling are provided. In high-speed applications where the heating effect is more pronounced, oil is specified (see [page 105](#)). Where minimum torque is a requirement, oil will usually provide lower friction values.

Grease offers certain advantages of its own. Because it is more easily retained, the design of bearing housings and seals is simplified. In many applications, the lubricant itself serves to exclude contaminants when used in conjunction with labyrinths or close clearances between the rotating and stationary structures. For the higher speeds within the range suitable for grease lubrication, a channeling type of grease is often selected.

Dry films and surface treatments have been used as bearing lubricants in applications subject to environmental extremes, particularly where conventional lubricants cannot be tolerated or will not survive. A wide variety of types are available for selection;

options include Tungsten disulfide, graphite, and Molybdenum disulfide.

It is important to note that the quantity of lubricant affects bearing performance under certain operating conditions. Only relatively small amounts of lubricant are necessary to reduce friction and wear if a film can be maintained on all contacting surfaces. Where speed is significant, excessive amounts of oil or grease will result in higher operating temperatures, leading to the possibility of early bearing fatigue. Depending on the bearing design and application, typical grease fill volumes vary from 10% to 30% of the free space available in the bearing.

Unsealed bearings are supplied with a coating of preservative-type oil for the prevention of corrosion during storage. Kaydon recommends that this preservative be removed with clean petroleum solvent prior to lubrication. If the preservative oil is not removed, the compatibility of the lubricant with the preservative oil must be confirmed.

In applications where minimum torque is required, the coating should be removed by washing with a clean petroleum solvent followed by immediate relubrication with an oil selected for the application. An option is to have Reali-Slim bearings factory lubricated with a commercial grease or oil selected by the customer in order to facilitate installation.

Sealed bearings are packed approximately one-third full with a multi-purpose industrial grease. Exterior surfaces are given a light coating of the same lubricant for protection during storage in the original package.

Lubrication and Maintenance of Reali-Slim Thin Section Bearings (continued)

Bearings, with or without seals, can be supplied with optional lubricants. Shown in the accompanying table are some of the greases and oils more frequently specified. Several have been developed to meet the requirements of unusual operating conditions. **Because of this and the variation in cost, it is recommended that lubricants be selected with the assistance of a lubrication expert.**

Due to the finite shelf life of any wet lubricant, factory lubricated bearings should not be held more than two years prior to use. Contact Kaydon for refurbishment instructions for product held beyond two years of receipt.

To realize the full potential of a Reali-Slim bearing, Kaydon recommends that the customer’s maintenance instructions and schedules consider the operating conditions and include procedures to assure the bearings are adequately protected against the intrusion of foreign matter of all types, and fresh oil or grease introduced with sufficient frequency to cleanse the bearing and assure adequate lubrication.

Figure 5-16

Lubrication Temperature Ranges

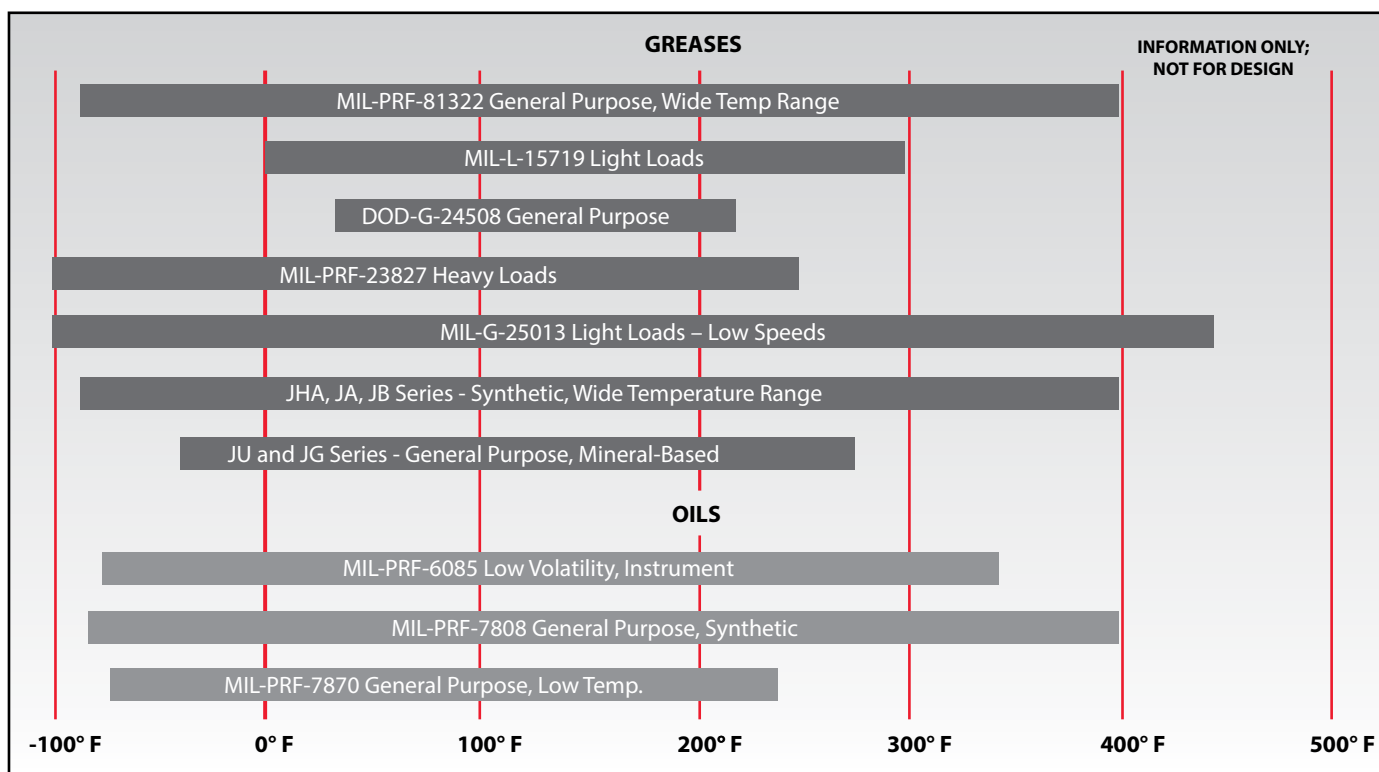

Section 6 — Other Products

**Page
Number**

- Bearings for Demanding Applications..... 123**
- KT Series Tapered Roller Bearings..... 125**

Other Products

Section 6

Bearings for Demanding Applications

(Material Codes S, N, X, Y, Q, M, P)

The Reali-Slim thin section bearing product line has been expanded to include several additional bearing series specifically engineered to bring the advantages of Reali-Slim bearings to designs intended for service in the most severe or extreme environments. We offer Reali-Slim bearings with a variety of packaged features to meet specific operation requirements.

Harsh Environments (S,N)

Kaydon stainless steel bearings are used where high precision and corrosion resistance are required.

Reali-Slim thin section bearings are available in AISI 440C stainless steel races (S) or with Kaydon's exclusive Endurakote plating (N). They are offered in either radial contact "C," angular contact "A," or four-point contact "X" configurations. These bearings are available in popular sizes and minimize the surface degradation and particulate formation so common in harsh environment applications. (See [pages 59-71](#).)

Low Particle Generation/Marginal Lubrication (X,Y)

Hybrid bearings are very well suited for applications where lubrication is marginal.

Applications requiring low particle generation, high accuracy, high speeds, and/or which must operate in adverse or no-lube conditions, can benefit from hybrid bearings. Tests have shown that significant reductions in particle generation can be obtained with hybrid designs which incorporate the use of ceramic rolling elements on hardened steel races. In addition, the physical properties of the ceramic rolling elements (precision, hardness, light weight) provide additional benefits such as improved repeatability, low torque, high stiffness, and resistance to wear under marginal or no-lube conditions.

High Performance, Low Torque (Q)

Series Q high-performance bearings are used where low friction torque, smooth operation, and high positional accuracy are required. Series Q high-performance bearings are generally limited to angular contact bearings supplied in either a back-to-back (DB) or face-to-face (DF) configuration. These bearings are made from Precision Class 6 Reali-Slim components with the following special modifications:

- Low-torque toroid ball spacers
- Special cleanroom cleaning
- Special lubrication
- Grade 10 balls or better
- Special ball path finishing
- Special preload assembly

High Temperature (M)

Standard bearings are processed for operating temperatures up to 250°F. At temperatures beyond this limit, reductions in material hardness can affect bearing capacity, which will reduce the bearing's theoretical fatigue life. When full capacity is required at higher temperatures, the use of series "M" bearings may be required. Manufactured from M50 tool steel for balls and races and assembled with stainless steel cages, these bearings can provide full bearing capacity at temperatures greater than 250°F. However, careful consideration to the bearing lubricant must also be exercised.

Bearings for Demanding Environments (continued)

Chemical Resistant (P)

In applications where both corrosion resistance and chemical resistance are required, series P bearings may be required. These bearings feature AISI 17-4PH steel races and ceramic balls. They are manufactured to provide a greater level of corrosion and chemical resistance than either Kaydon Series N or Series S bearings. Due to the hardening limitations of AISI 17-4PH steel, an adjustment factor of .17 must be applied to the standard dynamic capacity ratings. Thus, the use of P Series bearings should be carefully reviewed prior to selection to determine if the life and capacity are adequate.

Tremendous benefits in performance can be obtained by matching not just size but also material to the application. These

alternative race and ball materials interact differently than traditional chrome steel bearings. Capacities, life calculations and stiffness will differ from other products in this catalog. Contact Kaydon for technical characteristics of hybrid Reali-Slim bearings.

Materials

Races	AISI 17-4PH steel
Balls	Borosilicate, glass, or ceramic
Cage	Type A; PTFE or Vespel® toroid ball spacers or 300 series steel ring
	Types C & X; Stainless steel or non-metallic composite ring

Specifications for Hybrid Reali-Slim Bearings

ITEM	DESCRIPTION MATERIAL ANALYSIS	REFERENCE SPECIFICATION
RACES	AISI 440C Stainless steel	AMS 5630
BALLS	Ceramic: Silicon Nitride	
SEPARATORS C, X BEARINGS A BEARINGS	P Type—Brass or non-metallic composite L Type—Nylon, fiberglass reinforced R Type—Brass or non-metallic composite G Type—Nylon, fiberglass reinforced	other options, see p. 100 ASTM B-36 or B-134 ASTM B-36 or B-134
PRECISION		
RACE DIMENSIONS	Kaydon Precision Class 1, Higher classes available	ABMA ABEC-1F or better
RACE RUNOUTS	Kaydon Precision Class 1, Higher classes available	ABMA ABEC-1F or better
BALLS	ABMA Grade 10 Stainless steel or Grade 5 ceramic	ANSI/ABMA/ISO 3290

KT Series

Tapered Roller Bearings



The Kaydon concept of standard bearings with lightweight, thin sections and large bore diameters includes tapered and radial roller bearings as well as ball bearings.

KT Series tapered roller bearings offer advantages to those designs requiring a bearing of higher capacity, which would

benefit from the many unique advantages of a thin section bearing. KT tapered roller bearings are used to advantage in applications ranging from oil field equipment to machine tool tables where space and weight considerations are meaningful.

KT Series standard tapered roller bearings have races and rollers of through-hardened AISI 52100 steel with a one-piece stamped

steel cage. When specified, they can be furnished in pairs, match ground for use with or without spacers.

The tapered roller bearings in this catalog are of the single-row radial type, designed primarily for application of radial load. While of separable construction, the rolling elements are retained in the separator.

Since this bearing assumes a contact angle of approximately 12° under an axial force, it does have a reasonable amount of thrust capacity. This capacity is unidirectional and is realized when the axial force is applied to the wide faces of the races.

As in the case of the angular contact ball bearing, the single row tapered roller bearing is commonly mounted in opposition to another bearing (usually of similar construction) to provide an axial force for establishing and maintaining the angle of contact. Two bearings of this type maybe mounted with the lines of contact converging outside of the bearings (back-to-back) or inside (face-to-face) with the former preferred for stability in the presence of overturning load.

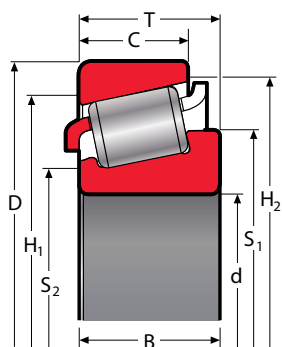

KAYDON Bearing Number	Bore d (IN)	Outside Dia. D (IN)	Assem. Width T (IN)	Factor K (IN)	Rating at 500 RPM for 3000 hrs. L-10		Cone Width B (IN)	Cup Width C (IN)	Shoulder Diameters				Approx. Bearing Wt. (LB)
					Radial (LB)	Thrust (LB)			Shaft		Housing		
									S1 (IN)	S2 (IN)	H1 (IN)	H2 (IN)	
KT-070	7.000	8.500	.812	1.74	4970	2860	.812	.625	7.375	7.300	8.125	8.250	3.11
KT-091	9.125	10.250	.718	1.79	4920	2750	.722	.597	9.625	9.312	9.850	10.050	2.88
KT-098	9.875	11.500	1.062	1.85	9260	5000	1.062	.875	10.375	10.225	11.063	11.250	6.05
KT-100	10.000	11.125	.625	1.79	4020	2250	.625	.500	10.500	10.300	10.750	10.900	2.88
KT-110	11.000	12.500	.875	1.86	7620	4100	.875	.688	11.438	11.250	12.000	12.250	5.06
KT-112	11.250	12.750	.812	1.86	7150	3860	.812	.625	11.688	11.500	12.313	12.500	4.72
KT-118	11.875	13.562	.937	1.76	7250	4120	.812	1.125	12.438	12.210	13.000	13.320	6.63
KT-130	13.000	14.562	.843	1.44	5580	3880	.843	.594	13.438	13.320	14.125	14.300	5.20
KT-132	13.250	15.000	.937	1.69	6160	3650	.937	.750	13.875	13.625	14.375	14.500	6.79
KT-151	15.125	17.375	1.125	1.72	11760	6840	1.125	.812	15.750	15.625	16.750	16.875	13.57
KT-165	16.500	18.750	.875	1.78	8220	4620	.882	.812	17.250	17.000	18.125	18.500	11.14
KT-180	18.000	19.625	.812	1.69	7400	4330	.812	.687	18.438	18.375	19.188	19.300	8.19
KT-200	20.000	21.750	.812	1.80	7930	4400	.812	.687	20.625	20.375	21.125	21.250	9.78

Tolerances are: Bore: +.001" - .000" up to KT-110; +.002" - .000" for KT-110 to KT-200
 Outside Diameter: Same as for bore.
 Width: ±.010" up to KT-112; ±.015" for KT-112 to KT-200
 Cup Radial Runout .0015" Max. F.I.M., Cone Radial Runout .0020" Max. F.I.M.

Other Products

Section 6

Section 7 — Appendix and Sales Information

	Page Number
■ Terms and Definitions	127
■ Warranty Information and Legal Notices	128
■ Disclaimer	
■ Hazard Notice	
■ Terms and Conditions of Sale - Warranty	
■ Responsibility Statement and Registered Trademarks	
■ Design Aids and Technical Literature	131
■ Distributors and Other Help	132
■ Request for Bearing Proposal Data Form	133
■ Conversion Factors	135

Bearing Definitions and Terms

Axial Clearance:

The total amount of free axial movement between the inner and outer race of a bearing. Bearings with internal clearance will contain both axial and radial clearance.

Axial Load:

Load applied to the bearing parallel with the bearing axis of rotation — also known as thrust load.

Capacity:

Dynamic capacity is the basic “C” rating which represents a load that the bearing can theoretically endure for 1 million revolutions. Static capacity is the approximate load the bearing can endure before permanent deformation occurs on the ball or raceway. Published capacities do not apply to hybrid series bearings P, X, and Y. Contact Kaydon product engineering for additional information.

Deflection:

The amount of movement associated with compression or stretching of bearing components when placed under load.

Diameter Tolerance:

The range in which the average diameter of a bore or O.D. may fall. Reali-Slim bearings are considered “non-rigid” rings and all diameters are averaged using multi-point gaging techniques per ABMA Std. 26.2.

Diametral Clearance:

The total free movement of the inner race relative to the outer race in a radial plane, also referred to as radial clearance. “X” and “C” type bearings are made with some internal clearance as a standard factory internal fit before mounting.

L_{10} Life:

The theoretical life span of a bearing under a specific set of dynamic operating conditions associated with 90% reliability.

Moment Load:

Load such that when applied to a bearing system, tends to overturn or bend the axis of rotation in an angular direction.

Pitch Diameter:

The theoretical median diameter of a bearing, which passes through the center of the rolling elements. Reali-Slim pitch diameters are equivalent to: $(OD+Bore)/2$.

Preload:

The amount of load placed on the rolling elements before the application of any external loads. Preload can be created in “X” and “C” type bearings by controlling internal fits of the ball and the raceway at the factory. Preload in angular contact bearings is controlled by a “preload gap” between the duplexed races. Tight mounting conditions will increase the final bearing preload. Preload stiffens the bearing and eliminates axial and radial play, but the load on the balls increases friction and shortens L_{10} life.

Radial Load:

Load applied perpendicular to the bearing axis of rotation.

Runout:

The maximum axial or radial race wall thickness variation of an inner or outer bearing race. Runout influences the repeatable location variation of rotating components.

Standard bearing nomenclature

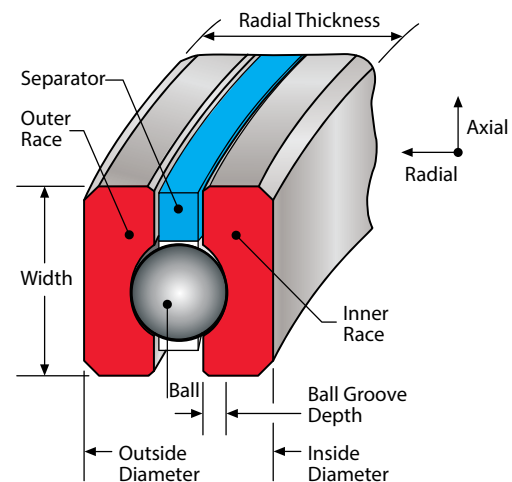

Warranty Information and Legal Notices

Disclaimer

The design and application information contained in this catalog is for illustration only. Responsibility for the application of the products contained in this catalog rests solely with the equipment designer or user. In spite of our best efforts, the material contained in this catalog may contain inaccuracies and typographical errors.

Hazard Notice

The use of any part, such as those described in this catalog, may be hazardous and have the potential to cause serious injury, including death, to people or property. The purchaser is responsible for evaluating the hazards associated with any part used in their application.

Kaydon Standard Terms and Conditions of Sale

- 1) **Scope.** Prices quoted are for acceptance within thirty (30) days from date of quotation unless otherwise stated. The terms and conditions of sale set forth below apply to all quotations made and purchase orders accepted by Seller.
- 2) **Acceptance of Orders.** All orders are subject to acceptance by authorized officials at Seller's division or subsidiary offices. All sales are made in accordance with these terms and conditions of sale. Any other document containing additional or different terms and conditions, or any attempt to vary these terms and conditions, shall be deemed a material alteration or modification hereof and all sales are made without such additional or different terms and conditions.
- 3) **Scheduling.** Shipping dates are approximate and are based upon prompt receipt of all necessary information. Buyer shall furnish to Seller written shipping instructions in sufficient time to permit Seller to make shipment at Seller's option within any time or times herein specified for shipment. In the event of a delay in delivery due to any reason described in Section 16 below, the delivery date shall be deferred for a period equal to the time lost by reason of delay. In the event such delay shall continue for more than two weeks, then, at Seller's option, the order will be deemed cancelled without liability to Seller.
- 4) **Quantities.** Seller reserves the right to ship quantities (or weight, as applicable) that are within ten percent (10%) of the quantity (or weight) specified by Buyer, and Seller shall not be liable for any overshipment or undershipment within this limit. In the event of any overshipment within this limit, Buyer shall pay for the actual quantity (or weight) shipped.
- 5) **Delivery and Transportation.** Seller's delivery dates are approximate. Seller shall not be liable for delays in delivery or other defaults in performance of this order arising out of causes beyond Seller's control. Unless otherwise agreed to in writing by Seller, delivery of the products hereunder shall be made F.O.B. at the point of shipment with delivery to the initial carrier to constitute delivery to the Buyer. Title to products passes to Buyer and products are at risks to Buyer from and after delivery to the initial carrier. Transportation expenses will be paid by Buyer and risk of loss, shortage, delay or damage to products in transit shall fall upon Buyer, whose responsibility it shall be to file claims with the carrier.
- 6) **Terms of Payment.** Invoices are due and payable (30) thirty days from the date of invoice unless other terms are shown on the face hereof. A 1-1/2% (one-and-a-half percent) carrying charge will be applied to all past due amounts. If shipments are delayed by Buyer, payments shall become due on the date when Seller is prepared to make shipment. If the work covered by the purchase order is delayed by Buyer, payments shall be made based on the purchase price and the percentage of completion. Seller reserves the right to ship to its order and

make collection by sight draft with bill of lading attached.

- 7) **Taxes.** Prices do not include foreign or domestic sales, use, excise or similar taxes. Consequently, in addition to the prices specified herein, the amount of any present or future sales, use, excise or other general or specific tax, or imports, duties or penalties or other governmental charges fixed or imposed by any lawful authority(s) upon or applicable to the production, sale, shipment, delivery or use of the products sold hereunder shall be added to the price and be paid by Buyer or, in lieu thereof, Buyer shall provide Seller with a tax exemption certificate acceptable to the taxing authorities. If such tax is paid by Seller, Buyer shall reimburse Seller upon presentation of invoice.
- 8) **Warranty.** Seller warrants the products manufactured by it to be free from defects in material and workmanship only. The extent of Seller's obligation hereunder is to either repair or replace its work or the defective products, F.O.B. Seller's plant, if returned within twelve (12) months after date of delivery. No allowance will be granted for repairs or alterations made by Buyer without Seller's written approval. The warranty shall not be construed to cover the cost of any work done by Buyer on material furnished by Seller or the cost of removal or installation of product. Products and parts not manufactured by Seller are warranted only to the extent and in the manner that the same are warranted to Seller by Seller's vendors and then only to the extent Seller is able to enforce such warranty. There is no other warranty, expressed or implied, in fact or by law.

THE FOREGOING STATES THE SOLE AND EXCLUSIVE WARRANTY OF BUYER AND THE SOLE AND EXCLUSIVE WARRANTY OF SELLER. THE WARRANTIES STATED IN THIS PARAGRAPH ARE IN LIEU OF ALL OTHER WARRANTIES WRITTEN OR VERBAL, STATUTORY, EXPRESSED OR IMPLIED, INCLUDING WARRANTIES OF MERCHANTABILITY AND FITNESS FOR A PARTICULAR PURPOSE, WHICH ARE HEREBY DISCLAIMED.

Seller's agreement to sell the products is made upon the condition and agreement that, with respect to the products, there have been no representations or undertakings made by or on behalf of Seller and Seller makes no guarantees or warranties, expressed or implied, in fact or in law, except as expressly stated above.
- 9) **Limitation of Liability.** Seller shall not be responsible, obligated, or liable for any injury or damage resulting from an application or use of its products, either singly or in combination with other products. SELLER'S SOLE LIABILITY FOR BREACH OF WARRANTY OR ANY OTHER CLAIM SHALL BE LIMITED TO REPAIR OR REPLACEMENT OF THE PRODUCTS OR RETURN OF THE PURCHASE PRICE, AT SELLER'S SOLE OPTION. SELLER SHALL NOT BE LIABLE FOR DAMAGES, INCLUDING BUT NOT LIMITED TO CONSEQUENTIAL OR SPECIAL DAMAGES ARISING OUT OF OR IN CONNECTION WITH THE USE OR PERFORMANCE OF THE PRODUCTS OR ARISING OUT OF ACCEPTANCE OF THIS ORDER.
- 10) **Acceptance of Products.** Products will be deemed accepted without any claim by Buyer unless written notice of non-acceptance is received by Seller within thirty (30) days of delivery if shipped F.O.B. point of shipment, or ten (10) days of delivery if shipped F.O.B. point of destination. Such written notice shall not be considered received by Seller unless it is accompanied by all freight bills for such shipment, with agent's notations as to damages, shortages and conditions of equipment, containers and seals. Non-accepted products are subject to return policy stated below.
- 11) **Return of Products.** No product may be returned to Seller without Seller's prior written permission, which permission may be withheld by Seller in its sole discretion.

Warranty Information and Legal Notices (continued)

- 12) Damages to Returned Products.** If Buyer elects to return product(s) to Seller for refurbishment, Buyer agrees to accept all risk of damage or destruction of such returned product(s), and Seller shall not be liable for any failure or inability on the part of Seller to complete refurbishment upon any such returned products.
- 13) Limitations of Actions.** Irrespective of whether Seller agreed to perform field start-up or any other service after the delivery of the product, all claims or actions must be brought within one (1) year of date of tender of delivery, or eighteen (18) months of Buyer's order, if no tender of delivery is made, notwithstanding any statutory period of limitation to the contrary.
- 14) Patents.** Buyer shall hold Seller harmless against any expense or loss resulting from infringement of patents or trademarks arising from compliance with Buyer's design, specifications or instructions.
- The sale of products or parts thereof by Seller does not convey any license by implication, estoppel, or otherwise under patent claims covering combinations of these products or parts with other devices or elements.
- 15) Financial Responsibility.** If in the sole judgment of Seller the financial resources of Buyer become impaired or unsatisfactory at any time during the term of the agreement between the parties, then Seller may require of Buyer a deposit or suitable security or margin for performance by Buyer in such amount or amounts from time to time as Seller shall specify. Upon requirement of deposit, Buyer shall make such deposit not later than the close of Seller's next business day. If Buyer fails to make such deposit, then Seller may at its option (1) cancel the agreement between the parties or the undelivered portion thereof, in which case Buyer agrees to pay Seller the difference between the market price on date of cancellation and the contract price; (2) resell at any time for Buyer's account all or any undelivered portion of the products, in which case Buyer agrees to pay Seller the difference between the resale price and the contract price, or (3) otherwise change the terms of payment. In the event Buyer shall be or becomes insolvent, or admits in writing Buyer's inability to pay Buyer's debts as they mature, or if Buyer shall make an assignment with creditors or if there are instituted by or against Buyer proceedings in bankruptcy or under any insolvency laws or for reorganization, receivership or dissolution, Seller may terminate the agreement between the parties at any time and without notice.
- 16) Force Majeure.** In the event of war, fire, epidemics, quarantine restrictions, flood, strike, labor trouble, breakage of equipment, accident, riot, the imposition of any government price control regulation or any other act of governmental authority, acts of God or other contingencies (whether similar or dissimilar to the foregoing) beyond the reasonable control of Seller, interfering with the production, supply, transportation, or consumption practice of Seller at the time respecting the products covered by the agreement between the parties or in the event of inability to obtain on terms deemed by Seller to be practicable any raw material (including energy source) used in connection therewith, quantities so affected shall be eliminated from the contract without liability, but the contract shall otherwise remain unaffected. Seller may during any period of shortage due to any of these causes, allocate its supply of such raw material among its various uses therefore (e.g. manufacturing and sales) in such manner as Seller deems practicable and allocate its supply of such products among such various uses thereof in any manner which Seller deems fair and reasonable.
- 17) Reasonable Attorneys' Fees.** In the event suit or other proceeding shall be brought for the recovery of the purchase price, or any unpaid balance or the breach by Buyer of any term of the agreement between Seller and Buyer, Buyer shall pay to Seller, in addition to any damages provided by law, reasonable attorneys' fees and costs of collection.
- 18) Security Title.** Security title and right of possession of the products sold hereunder shall remain with Seller until all payments due from Buyer to Seller (including deferred payments whether evidenced by notes or otherwise) shall have been made in cash and Buyer agrees to do all acts necessary to perfect and maintain such security right and title in Seller.
- 19) Cancellations.** Buyer may cancel an order only upon written consent and upon payment to Seller of cancellation charges, which shall take into account among other things expenses incurred and commitments already made by Seller, and Seller's profit margin.
- 20) General**
- (a) The agreement between Buyer and Seller and matters connected with the performance thereof shall be construed in accordance with and governed by the law of the State of Seller's accepting offices, as referenced in Section 2, as though it were executed and performed entirely within the State of Seller's accepting offices, as referenced in Section 2, and shall be construed to be between merchants.
 - (b) Any assignment of the agreement between Buyer and Seller or any rights or obligation of the agreement by Buyer without written consent of Seller shall be void.
 - (c) Except as may be expressly provided to the contrary in writing, the provisions of the agreement between Buyer and Seller are for the benefit of the parties hereto and not for any other person.
 - (d) No waiver by Seller of any breach of any provision of the agreement between Buyer and Seller will constitute a waiver of any other breach.
 - (e) The terms and conditions set forth above contain all the representations, stipulations, warranties, agreements and understandings with respect to the subject matter of the agreement between Buyer and Seller, and its execution has not been induced by any representation, stipulation, warranty, agreement or understanding (including any course of prior dealings between the parties hereto) of any kind other than those set forth above.
 - (f) No amendment, addition to, alteration, modification or waiver of all or part of the agreement between Buyer and Seller shall be of any force or effect unless in writing and signed by Seller. If the terms and conditions set forth above conflict with those of any purchase order of Buyer written in connection with the sale of the products or any portion thereof, then the terms set forth above shall govern.
- 21) Arbitration.** Any controversy or claim arising out of or relating to the agreement between Buyer and Seller, or the breach thereof, shall be settled in the City and State of the Seller's accepting offices, as referenced in Section 2, by arbitration in accordance with the Rules of the American Arbitration Association, and judgment upon the award rendered by the arbitrator may be entered in any court having jurisdiction thereof.

“RESPONSIBILITY STATEMENT”

WARNING

FAILURE OF, OR IMPROPER SELECTION OF, OR IMPROPER USE OF THE PRODUCTS DESCRIBED HEREIN OR RELATED ITEMS CAN CAUSE DEATH, PERSONAL INJURY AND PROPERTY DAMAGE.

This document and other information from Kaydon Bearings and authorized distributors provides product or system options for further investigation by users having technical expertise. Before you select or use any product or system, it is important that you analyze all aspects of your application and review the information concerning the product in the current product catalog. The user, through its own analysis and testing, is solely responsible for making the final selection of the product or system and assuring that all performance, safety and warning requirements of the application are met. The products and systems described herein, including without limitation, product features, specifications, designs, availability and pricing, are subject to change by Kaydon Bearings at any time without notice.

The following are registered trademarks of Kaydon Bearings: Endurakote, Endura-Slim, Reali-Design, Reali-Design MM, Reali-Slim, Reali-Slim TT, Reali-Slim MM, Ultra-Slim

Application Information to Help In Your Designs

All available for download from our website www.kaydonbearings.com.



1. Reali-Slim thin section bearings catalog

Complete engineering and selection information on the entire product line, including Reali-Slim MM metric series, Reali-Slim TT turntable series, and Ultra-Slim series. 136 pages.

Catalog 300



2. Stainless steel Reali-Slim bearings brochure

Open, sealed and custom bearings for harsh environments, including specifications, mountings and typical applications. 4 pages. **Stainless Steel Bearings**



3. Reali-Design and Reali-Slim MM software

Speeds Reali-Slim bearing selection process. Includes data sheets, life calculations, and CAD-ready DXF library for both inch and metric series. Software downloadable from www.kaydonbearings.com.



4. Kaydon Bearings applications guide

See more than 160 applications for Reali-Slim and slewing ring bearings, in markets as diverse as aerospace, semiconductors and heavy equipment. 8 pages. **Applications Guide**



5. Slewing ring/turntable bearing catalog

Complete engineering and selection information on standard and custom turntable bearings up to 240". 132 pages. **Catalog 390**



6. Bearing Remanufacturing program brochure

Overview of ISO-certified repair services provided by Kaydon to remanufacture 10" to 240" diameter bearings to like-new quality and warranty, any OEM. 6 pages. **Remanufactured Bearings**

Help is Just a Call, Click or Fax Away

It's easy to contact Kaydon from your desktop, laptop, tablet, or mobile phone.

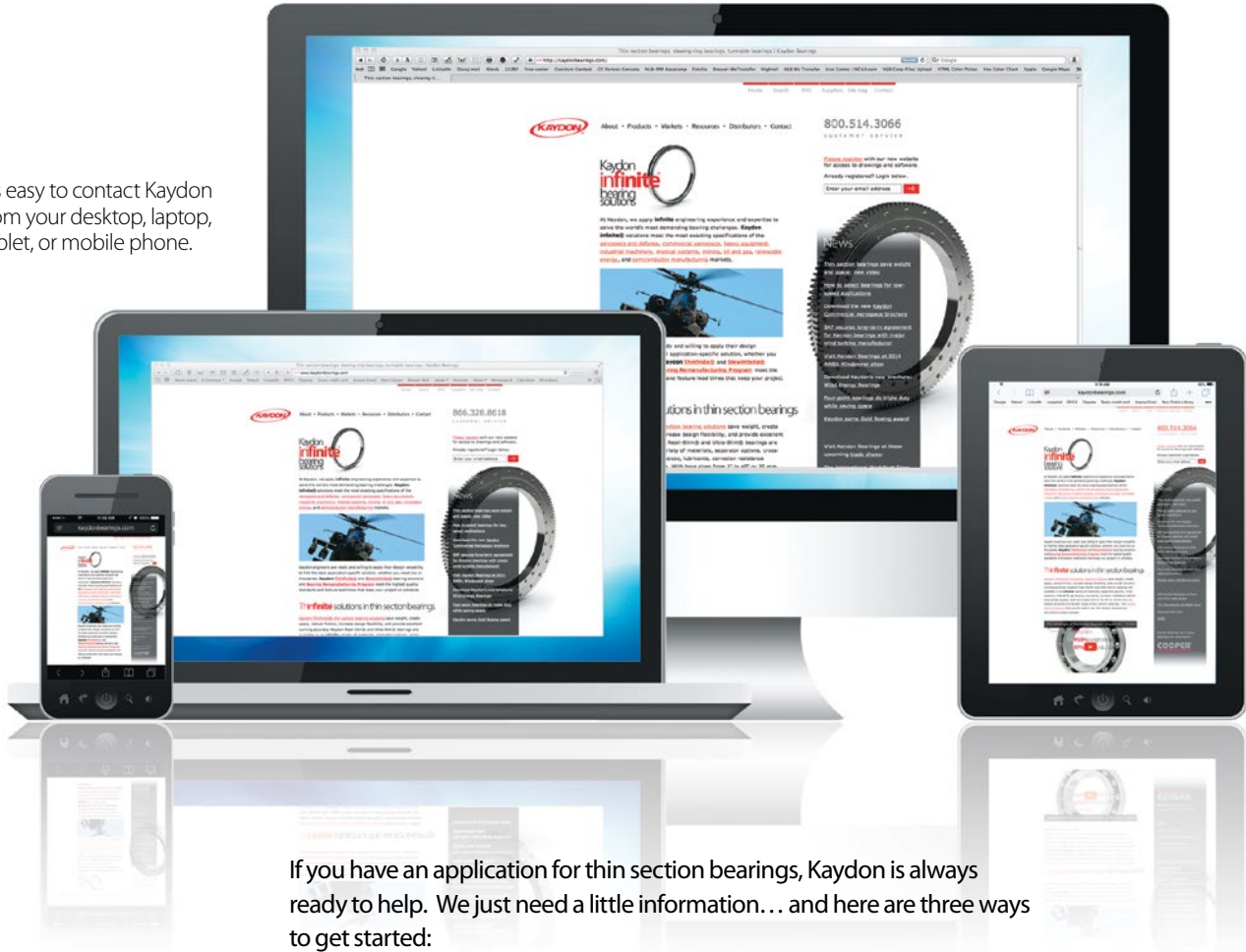

If you have an application for thin section bearings, Kaydon is always ready to help. We just need a little information... and here are three ways to get started:

- 1) Call and ask to speak with an application engineer. In the U.S.; call toll free, 800-514-3066. From other countries, call 231-755-3741.
- 2) Fill out the step-by-step Request for Proposal form on the facing page and fax it to Kaydon at 231-759-4102.
- 3) Contact one of the many qualified distributors who represent Kaydon in North America and around the world.

Kaydon distributors are trained bearing specialists with a wide range of applications experience, backed by our comprehensive technical support program. For the name and location of the Kaydon distributor nearest you, please visit the appropriate page at our website:

U.S. and Canada -

<http://www.kaydonbearings.com/distributors.htm>

International -

<http://www.kaydonbearings.com/international.htm>

By phone, fax, or through a distributor, the Kaydon team welcomes your inquiry and looks forward to an opportunity to serve your bearing needs.

Request For Bearing Proposal Data Form

Detach and fax completed form or complete and submit online at www.kaydonbearings.com.

Attention: Kaydon Sales

Date: _____

TO: Kaydon Bearings
 Muskegon, Michigan 49443
Fax: 231-759-4102 **Phone:** 231-755-3741

FROM: _____

Project Description:

Application: _____
 Type: _____
 Annual Quantity: _____
 Quotation Quantity: _____
 Program Start Date: _____
 Response from Kaydon Needed by: _____

For a preferred Size and Style of Bearing:

Preselected Kaydon Bearing Model #: _____

or

Bore: _____ inches O.D.: _____ inches Width: _____ inches

or

Envelope Size : _____ Min. Bore inches _____ Max. O.D. inches _____ Max. Width inches

For an L_{10} life calculation: [Describe loads and/or mass on bearing]

Dynamic Radial avg.: _____ pounds
 Dynamic Axial avg.: _____ pounds
 Dynamic Moment avg.: _____ inch-lbs.
 RPM (max) _____ RPM (min) _____ **or** Oscillation: Angle _____ Duty Cycle _____
 Bearing axis is vert horiz with the inner outer race rotation relative to load
 Minimum Hours needed: _____

For a Safety factor calculation: [describe any maximum shock or impact Loads]
[Note: Do not include Safety factor in these loading values !!!!]

Static Radial Max: _____ pounds
 Static Axial Max: _____ pounds
 Static Moment Max: _____ inch-lbs.

For determining Shaft and Housing sizes: [Attach proposed mounting sketch if possible]

	Material	Radial Thickness	Low Temperature	Normal Temperature	High Temperature
Shaft	_____	_____	_____	_____	_____
Housing	_____	_____	_____	_____	_____

For Accuracy concerns:

Kaydon Precision Class _____
or
 Radial Runout _____ Axial Runout _____

For Stiffness or Deflection concerns:

Springrate: _____
or
 Movement under load: _____

For Torque to Rotate concerns:

Maximum allowable Starting Torque: _____

For Other or Environmental Conditions:

Operating Temperature Range: _____
 Vacuum Range: _____
 Proposed Lubricant is : _____
 Seals or Shields: _____
 Protective Coating: _____

Mounting Sketch

Attach a separate document to show sketch

Fax Request for Bearing Proposal Data Form to:

(231) 759-4102

Conversion Factors

	English-Metric	Metric-English
Length	1 in = 25.4 mm	1 mm = .03937 in
	1 ft = .3048 m	1 m = 3.281 ft
Force	1 lb = 4.448 N	1 N = 0.2248 lb
Torque/Moment	1 ft-lb = 1.356 N-m	1 N-m = .7376 ft-lb
	1 in-lb = .113 N-m	1 N-m = 8.851 in-lb
	1 in-oz = 72.01 gf-cm	1 gf-cm = .01389 in-oz
Weight	1 lb = .4536 kg	1 kg = 2.205 lb
	1 oz = 28.35 g	1 g = .03527 oz
Stress / Pressure	1 psi = 6895 Pa (N/m ²)	1 Pa = .000145 psi
	1 ksi = 6.895 MPa (N/mm ²)	1 MPa = .145 ksi
Temperature	(°F - 32) / 1.8 = °C	1.8 x °C + 32 = °F

(rounded to 4 significant digits)

Kaydon
Thinfinite[®]
bearing
solutions

A thin, circular bearing ring is shown in a three-quarter view, highlighting its extreme thinness. It is positioned to the right of the 'Thinfinite' text, with the 'i' in 'Thinfinite' overlapping the ring.

Kaydon Bearings
2860 McCracken Street
Muskegon, Michigan 49441 U.S.A.
231.755.3741 tel
800.514.3066 free
231.759.4102 fax
bearings@kaydon.com
www.kaydonbearings.com

